

# Master

catalog

**RICE LAKE**  
WEIGHING SYSTEMS

800-472-6703 [www.ricelake.com](http://www.ricelake.com) **2015**

# Our Ide

Dating back to our origin in 1946, providing unmatched service has always been the focus of our business. Rice Lake's unique beginning as a service company helped construct this principle and it has endured the test of time. It is ingrained in everything we do and continues to be the epicenter of our identity.

Today, Rice Lake Weighing Systems carries over 40,000 different products in stock and ready to ship, meeting the needs of almost any weight-related and process control application. We also routinely build custom solutions for applications outside the norm, delivering a valuable on-demand response for products in complex configured systems.

Over 80 percent of orders we receive are shipped the same day because we recognize the value of time. We put our customers first, making Rice Lake the scale industry's first choice.

Service, selection, and speed—this phrase defines Rice Lake Weighing Systems. **It's in our DNA.**

## Service.

Represented by the most dedicated scale experts in the industry, we provide unmatched service for our customers, 24 hours a day, 7 days a week, 365 days a year.



# ntity



## Selection.

We have the largest industry inventory with more than 40,000 items in stock and available for same day shipping, plus the ability to design custom equipment and integrated systems.



## Speed.

Over 80% of orders we receive are shipped the same day. Our speed is unparalleled, putting our customers and the value of their time first.

**RICE LAKE**<sup>®</sup>  
WEIGHING SYSTEMS

To be the best by every measure<sup>®</sup>

800-472-6703

[www.ricelake.com](http://www.ricelake.com)



# Rice Lake Technical Training Class is in Session

Throw on your ball cap and pack up your mini screwdrivers because Rice Lake Weighing Systems is now accepting students for our 2015 Technical Training School. New and experienced scale technicians can learn from the best in the industry who teach, demonstrate and work one-on-one with students. By using the latest weighing equipment, software and techniques, students are able to leave Rice Lake's technical training with the confidence to successfully sell, service and apply targeted weighing solutions.



### **ES-111 Fundamentals of Electronic Systems**

Beginning scale technicians receive hands-on training in the basics of calibration, configuration, serial interfacing and troubleshooting components from load cells and indicators, to printers and peripherals.

**2015: February, March, May, July, October and December**

### **ES-222 Advanced Scale System Troubleshooting**

Systematic and methodical approach to troubleshooting for the intermediate technician.

Focus is heavily centered on less lecture and more lab work.

**2015: February, April and September**

### **ES-300 Indicator Formatting and Process Control**

Learn the basic setup and configuration of the 720i™, 820i® and other programmable indicators using the front panel and software tools such as iRev, Revolution® and ProAction PCEE.

Students will also learn about the use of setpoints and as an added bonus, we teach how to set up and use the iQUBE2® junction box.

**2015: January, June and November**

### **ES-301 920i® Advanced Programming**

Study components and syntax of iRite® programming language with hands-on exercises and examples.

Gain experience writing, compiling, editing and downloading the 920i programs. Explore capabilities of the 920i database.

**2015: January, June and November**

### **MS-101 Understanding Mechanical Scales**

In today's automated industry, many technicians have never acquired the skills to service mechanical scales.

This class will focus on pivots and bearings, levers, scales, scale recognition, maintenance and repair, beams/portable beam scales, dial scales, motor truck scales and electromechanical conversions.

**2015: October Only**

### **SA-101 Sales and Application Training**

Students gain the confidence that closes sales. Beginning with an overview of the market for weighing equipment and technology, students learn where weighing equipment serves in specific vertical markets including agriculture, chemical, food and beverage, manufacturing, natural resources, research and education, transportation and logistics, waste and recycling, and wholesale and retail trade. Product categories and industry approvals and codes are defined and sales support is reviewed.

**2015: September Only**

Visit [www.ricelake.com/training](http://www.ricelake.com/training) for more details,  
or call and ask for our training coordinator: **US 1-800-472-6703**

**International 1-715-234-9171**

**Canada/Mexico 1-800-321-6703**

**RICE LAKE®**  
WEIGHING SYSTEMS

To be the best by every measure®

800-472-6703

[www.ricelake.com](http://www.ricelake.com)

# Table of Contents

## Automated Ticketing

<b>Weigh Out/Printer Kiosk</b> .....	<b>26</b>
Automated Truck Scale System	
<b>Weigh/Check In Kiosk</b> .....	<b>28</b>
Automated Truck Scale System	
<b>Printer Kiosk</b> .....	<b>29</b>
Automated Ticketing Printer Kiosk	
<b>OnTrak™</b> .....	<b>32</b>
Truck Data Management Software	
<b>TransAct® LE/TransAct/TransAct Plus</b> .....	<b>34</b>
Truck Data Management Software	
<b>Kiosk Safety Swing-Away Arm</b> .....	<b>36</b>
Self Centering Kiosk Mount	
<b>Vehicle Loop Detector</b> .....	<b>37</b>
<b>EMX Lite Preformed Loops®</b> .....	<b>37</b>
<b>RFID</b> .....	<b>38</b>
Transcore® SmartPass®	
<b>RFID Access Tags</b> .....	<b>39</b>
<b>RFID Transportation Tags</b> .....	<b>40</b>
<b>HID RFID Cards, Keys and Tags</b> .....	<b>40</b>
<b>HID RFID Readers</b> .....	<b>41</b>
<b>Model G-89 Barrier Gate</b> .....	<b>42</b>
<b>Photo Eyes</b> .....	<b>42</b>
<b>Traffic Light Kits</b> .....	<b>43</b>
<b>Intercom AI PHONE</b> .....	<b>44</b>

## Aviation

<b>Tracer® AV</b> .....	<b>48</b>
Baggage Weighing Instrumentation	

## Balances

<b>Equipoise Series</b> .....	<b>52</b>
Compact Balance	
<b>TC Series</b> .....	<b>54</b>
Tuning Fork Compact Balance	
<b>TP Series</b> .....	<b>56</b>
Tuning Fork Precision Balance	
<b>TS Series</b> .....	<b>58</b>
Tuning Fork Stainless Steel Balance	
<b>TA Series</b> .....	<b>60</b>
Tuning Fork Analytical Balance	
<b>MC Series</b> .....	<b>62</b>
Mass Comparator	
<b>Ion BM Series</b> .....	<b>64</b>
Micro, Semi-Micro Analytical Balances	
<b>Phoenix GH Series</b> .....	<b>66</b>
Analytical/Semi-Micro Balances	
<b>Gemini GR Series</b> .....	<b>68</b>
Analytical/Semi-Micro	
<b>HR-AZ/A Series</b> .....	<b>70</b>
Analytical Balance	
<b>Orion HR Series</b> .....	<b>72</b>
Analytical/Semi-Micro	
<b>AD-4212A Series</b> .....	<b>74</b>
Analytical Balances	
<b>GX Series</b> .....	<b>77</b>
Toploader Balances	
<b>GF Series</b> .....	<b>80</b>
Toploader Balances	
<b>GF-P Series</b> .....	<b>83</b>
Toploader Balances	
<b>FXi Series</b> .....	<b>84</b>
Toploader Balances	
<b>FXi-WP Series</b> .....	<b>86</b>
Toploader Balances	
<b>AD-1683</b> .....	<b>88</b>
Static Eliminator	
<b>EJ Newton Series</b> .....	<b>89</b>
Compact Balances	
<b>EK-i Series</b> .....	<b>91</b>
Compact Balances	
<b>EW-i Series</b> .....	<b>94</b>
Compact Balances	
<b>GX-K Series</b> .....	<b>96</b>
Industrial Balances	
<b>GF-K Series</b> .....	<b>98</b>
Precision Balances	
<b>GP Series</b> .....	<b>100</b>
Industrial Balances	
<b>MS-70/MX-50/MF-50 Series</b> .....	<b>103</b>
Moisture Analyzers	
<b>Discovery™</b> .....	<b>105</b>
Semi-Micro and Analytical Balances	
<b>Pioneer™</b> .....	<b>107</b>
Analytical/Precision Balances	
<b>Explorer®</b> .....	<b>109</b>
Analytical Balances	
<b>Explorer®</b> .....	<b>111</b>
Precision	
<b>Explorer® Pro</b> .....	<b>113</b>
High Capacity	
<b>Adventurer Pro®</b> .....	<b>115</b>
Precision Balances	
<b>MB Series</b> .....	<b>117</b>
Moisture Analyzer	
<b>Scout Pro®</b> .....	<b>119</b>
Portable Electronic Balances	
<b>CS Series</b> .....	<b>121</b>
Compact Scale	
<b>CL Series</b> .....	<b>122</b>
Compact Scale	
<b>HH Series</b> .....	<b>123</b>
Handheld Compact Scale	
<b>YA Series</b> .....	<b>124</b>
Pocket Scale	
<b>Triple Beam</b> .....	<b>125</b>
Mechanical Balance	
<b>Harvard Trip Balance</b> .....	<b>127</b>
Mechanical Beam	
<b>Dial-O-Gram® and Cent-O-Gram®</b> .....	<b>128</b>
Mechanical Balances	
<b>Field Test Scale</b> .....	<b>129</b>
Mechanical Balance	
<b>Heavy Duty Solution</b> .....	<b>130</b>
<b>FD Series</b> .....	<b>131</b>
Food Portioning Scale	
<b>Navigator™ XT</b> .....	<b>133</b>
Battery-Operated Compact Scale	

<b>Valor® 7000</b> .....	<b>134</b>	<b>BenchMark™ HDP</b> .....	<b>180</b>
Compact Bench Scales		Portable Heavy Duty Bench Scales	
<b>Valor® 3000 Xtreme</b> .....	<b>135</b>	<b>DIGI® S-YA/S-YB</b> .....	<b>181</b>
Compact Precision Scales		<b>DIGI® S-T-U-V</b> .....	<b>182</b>
<b>Valor® 3000 Xtreme</b> .....	<b>136</b>	<b>DIGI® Bench Scale and Indicator Package</b> .....	<b>183</b>
Compact Washdown Scales		<b>Ishida iPC Series</b> .....	<b>184</b>
<b>Valor® 2000</b> .....	<b>137</b>	Portable Bench Scales	
<b>Compact Washdown Scales</b>		<b>Versa-portion®</b> .....	<b>186</b>
<b>Valor® 1000</b> .....	<b>138</b>	Compact Scale	
Compact Precision Scales		<b>Ishida IGX and IGB Series</b> .....	<b>187</b>
<b>Cubis®</b> .....	<b>139</b>	<b>Checkweighers</b>	
Ultra-micro/Micro		<b>IQ plus® 2100</b> .....	<b>190</b>
<b>Cubis®</b> .....	<b>141</b>	Digital Bench Scale	
Semi-Micro and Analytical Balances		<b>IQ plus® 2100SL</b> .....	<b>192</b>
<b>Cubis®</b> .....	<b>143</b>	Digital Bench Scale	
Milligram Balances		<b>CW-90</b> .....	<b>194</b>
<b>Cubis®</b> .....	<b>145</b>	Over/Under Checkweigher	
Toploading Balances		<b>CW-90X</b> .....	<b>196</b>
<b>CPA Series</b> .....	<b>148</b>	Over/Under Checkweigher Washdown	
Micro Analytical Balances		<b>Concrete Batch Controller</b>	
<b>Practum/Quintix/Secura</b> .....	<b>149</b>	<b>CB-2 Concrete Batch Controller</b> .....	<b>200</b>
Analytical		Multi-Scale Automated Batching System	
<b>Practum/Quintix/Secura</b> .....	<b>151</b>	<b>Counting Scales</b>	
Precision		<b>Counterpart®</b> .....	<b>204</b>
<b>Entris</b> .....	<b>153</b>	Configurable Counting Indicator	
<b>AbleCable®</b> .....	<b>156</b>	<b>DIGI® DC-782 Series</b> .....	<b>206</b>
<b>RS 232/USB Serial Smart Cable Direct, Keyboard Input Direct</b>		Portable Counting Scales	
<b>go-between</b> .....	<b>157</b>	<b>DIGI® DC-788 Series</b> .....	<b>207</b>
Data Capture and Storage		Industrial Counting Scales	
<b>Standard Balance Slab</b> .....	<b>158</b>	<b>DIGI® S-YC Series</b> .....	<b>209</b>
<b>Clean Room Table</b> .....	<b>158</b>	Remote Scale Base Platforms	
Granite		<b>A&amp;D® FC-i/Si Series</b> .....	<b>210</b>
<b>Scoops</b> .....	<b>158</b>	High Resolution Counting Scale	
Kasota Stone		<b>A&amp;D® HC-i Series</b> .....	<b>211</b>
<b>Standard Balance Table</b> .....	<b>158</b>	<b>OHAUS® Ranger™ Count 3000</b> .....	<b>212</b>
Kasota Stone		Industrial Counting Scales	
<b>Anti-Vibration</b> .....	<b>158</b>	<b>DIGI® DMC-782 Series</b> .....	<b>213</b>
<b>Prove™ Statistical Printer</b> .....	<b>159</b>	Portable Coin Counting Scales	
<b>Belt Scales</b>		<b>Crane Scales</b>	
<b>311M</b> .....	<b>162</b>	<b>MSI-3460 Challenger 3</b> .....	<b>216</b>
Medium to Heavy Capacity Belt Scale		<b>MSI-4260 Port-A-Weigh</b> .....	<b>218</b>
<b>221DB</b> .....	<b>163</b>	<b>MSI-4300 Port-A-Weigh Plus</b> .....	<b>220</b>
Medium to Heavy Capacity Belt Scale		<b>MSI-9300 Port-A-Weigh Plus</b> .....	<b>222</b>
<b>Belt Scale Integrator</b> .....	<b>164</b>	<b>CellScale™ RF</b> .....	<b>222</b>
<b>BCi</b> .....	<b>165</b>	<b>MSI-9300HT Hi-Torque Port-A-Weigh Plus CellScale™ RF</b> .....	<b>224</b>
Weigh Frames		<b>MSI-6260CS Trans-Weigh CellScale™ RF</b> .....	<b>226</b>
<b>Belt Scale Accessories</b> .....	<b>166</b>	<b>MSI-7300 Dyna-Link 2</b> .....	<b>228</b>
<b>Belt Scale Questionnaire</b> .....	<b>168</b>	Digital Tension Dynamometer	
<b>Bench Scales</b>		<b>MSI-8000</b> .....	<b>231</b>
<b>BenchMark® SL, CW-80B, SL/HE Series</b> .....	<b>172</b>	RF Remote Display	
Light-Capacity Bench Scales		<b>MSI-8000HD</b> .....	<b>232</b>
<b>CW-90B</b> .....	<b>174</b>	Indicator/Remote Display	
Light-Capacity Bench Scales		<b>TranSend™ Wireless Load Cell Interface System</b> .....	<b>233</b>
<b>CW-90XB</b> .....	<b>175</b>		
Light-Capacity Bench Scales			
<b>BenchMark™</b> .....	<b>176</b>		
Mild, Stainless Steel, HE Series			
<b>BenchMark™ LP</b> .....	<b>178</b>		
Low Profile Bench Scales			
<b>BenchMark™ HD</b> .....	<b>179</b>		
Heavy Duty Bench Scales			



<b>MSI-9850 CellScale™ RF Digital Indicator</b> .....	<b>235</b>	<b>Bumper Guards</b> .....	<b>288</b>
<b>MSI-9750A CellScale™ RF Portable Indicator</b> .....	<b>237</b>	Option A	
<b>MSI-9000 CellScale™</b> .....	<b>238</b>	<b>Bumper Guards</b> .....	<b>289</b>
<b>MSI-9020 CellScale™ RF CellModem</b> .....	<b>240</b>	Option B	
<b>MSI Scoreboards Wireless RF</b> .....	<b>241</b>	<b>Bumper Guards</b> .....	<b>290</b>
Remote Displays		Option C	
<b>Shackle Dimensions</b> .....	<b>242</b>	<b>RoughDeck® HP and SS</b> .....	<b>291</b>
<b>Intercomp CS™ 200</b> .....	<b>243</b>	Portability Frames	
<b>Intercomp CS™ 750</b> .....	<b>244</b>	<b>RoughDeck® HP Caster</b> .....	<b>292</b>
<b>Intercomp CS™ 1500</b> .....	<b>245</b>	Portability Frames	
<b>Intercomp CS™ 3000-RFX</b> .....	<b>247</b>	<b>RoughDeck® HP, SS &amp; HE</b> .....	<b>293</b>
<b>Intercomp TL 8500</b> .....	<b>249</b>	Pit Frame Concrete Details*	
<b>Dimensioning</b>		<b>RoughDeck® HP-H</b> .....	<b>294</b>
<b>iDimension™ 200/300 Series</b> .....	<b>252</b>	Pit Frame Concrete Details* - 20,000lb Capacity	
3D Imaging System		<b>RoughDeck® HP-H</b> .....	<b>295</b>
<b>Floor Scales</b>		Pit Frame Concrete Details* - 30,000lb Capacity	
<b>RoughDeck® Rough-n-Ready System</b> .....	<b>254</b>	<b>AutoLift HE</b> .....	<b>296</b>
Floor Scale/Indicator Package		Pit Frame Concrete Details*	
<b>RoughDeck® and iQUBE 2®</b>		<b>RoughDeck® QC</b> .....	<b>297</b>
<b>Rough-n-Ready System</b> .....	<b>256</b>	Pit Frame Concrete Details*	
<b>RoughDeck® HP</b> .....	<b>258</b>	<b>Summit® 3000</b> .....	<b>298</b>
High Performance Structural Steel Low-Profile Floor Scale		Pit Frame Concrete Details*	
<b>RoughDeck® HP-H</b> .....	<b>260</b>	<b>Forklift/Pallet Jack Scales</b>	
Heavy Capacity Floor Scale		<b>CLS-420 Wired Version</b> .....	<b>300</b>
<b>RoughDeck® CS</b> .....	<b>262</b>	Cargo Lift Scale	
Coil Scale		<b>CLS-420 Wireless Version</b> .....	<b>303</b>
<b>RoughDeck® SS</b> .....	<b>264</b>	Cargo Lift Scale	
Stainless Steel Low-Profile Floor Scale		<b>CLS-920i® Wired Version</b> .....	<b>306</b>
<b>RoughDeck® HE</b> .....	<b>265</b>	Cargo Lift Scale	
Hostile Environment Stainless Steel Low-Profile Floor Scale		<b>CLS-920i® Wireless Version</b> .....	<b>309</b>
<b>AutoLift HE</b> .....	<b>266</b>	Cargo Lift Scale	
Hostile Environment Stainless Steel Low-Profile Lift Floor Scale		<b>Intercomp PW800™</b> .....	<b>312</b>
<b>RoughDeck® QC</b> .....	<b>268</b>	Pallet Truck Scale	
Quick Clean Stainless Steel Floor Scale		<b>Hanging Scales</b>	
<b>RoughDeck® SD</b> .....	<b>270</b>	<b>Rice Lake On-Site OS-10/OS-25/OS-45</b> .....	<b>314</b>
Sanitary Deck Floor Scale		<b>Salter Model 235-6S</b> .....	<b>315</b>
<b>RoughDeck® BDP</b> .....	<b>272</b>	<b>Salter Electro Samson</b> .....	<b>316</b>
Barrel Scale - Standard Model		<b>Hardware</b>	
<b>RoughDeck® BDP</b> .....	<b>274</b>	<b>Load Cell Mounting Hardware Safety Guidelines</b> .....	<b>318</b>
Barrel Scale - Standard Model with Portability Option		<b>Mounting Assembly Component Identification</b> .....	<b>319</b>
<b>DeckHand Rough-n-Ready System</b> .....	<b>276</b>	<b>Jam Nuts</b> .....	<b>319</b>
Portable Scale		<b>Eye Nuts</b> .....	<b>320</b>
<b>DeckHand</b> .....	<b>277</b>	<b>Coupling Nuts</b> .....	<b>320</b>
Portable Scale		<b>Clevis Mount Assemblies</b> .....	<b>321</b>
<b>RL1200</b> .....	<b>278</b>	<b>Load Cell Eye Bolts</b> .....	<b>322</b>
Portable Beam Scale		<b>Rod End Ball Joints</b> .....	<b>323</b>
<b>RL1200 EM</b> .....	<b>279</b>	<b>Connecting Links</b> .....	<b>324</b>
Electromechanical Portable Beam Scale		<b>Load Cell Isolators</b> .....	<b>324</b>
<b>RoughDeck® FXB</b> .....	<b>280</b>	<b>Threaded Adapters</b> .....	<b>325</b>
Flexure Lever Floor Scale		<b>ITCM - Isolated Tension Cell Mount Hardware Kits</b> .....	<b>326</b>
<b>Floor Scale and Indicator Package</b> .....	<b>282</b>	<b>Grounding Strap</b> .....	<b>327</b>
<b>Summit® 3000</b> .....	<b>284</b>	<b>Load Receiver Plate</b> .....	<b>327</b>
Low-Profile Floor Scale			
<b>Floor Scale</b> .....	<b>286</b>		
Access Ramps			
<b>Floor Scale</b> .....	<b>287</b>		
Pit Frames			

Ball Bearings.....	328	Static Brushes.....	352
Load Cups.....	328	Ionizing Strips.....	352
Cardinal® Wire Rope Replacement Assemblies.....	329	Ionizing Strips Accessories.....	352
Custom Wire Ropes.....	329	Desiccants.....	353
Wire Rope Assemblies.....	329	Industrial Corrosion Inhibitor.....	353
Custom Wire Rope Definition.....	330	Crimper and Lead Seals.....	353
Spherical Washer Sets.....	331	Static Control Table Mat and Floor Mat.....	354
Weldless End Links.....	331	Static Control Wrist Strap.....	354
Load Cell Spacers.....	332	Static Shielding Bags.....	354
Load Button.....	332	Static-Safe Service Kit.....	355
Load Button Insert Kit.....	332	Portable Megometer.....	355
Surefoot™.....	333	<b>Indicators/Controllers</b>	
Flintec™ Adjustable Rubber Foot.....	333	120/120 Plus.....	360
Bench Scale Feet.....	334	Digital Weight Indicator	
Polyurethane Rubber Leveling.....	334	<b>IQ plus® 210</b> .....	362
Captured Ball Floor Scale Leveling Feet.....	335	Digital Weight Indicator	
Leveling Pads.....	336	<b>IQ plus® 390-DC</b> .....	363
Leveling Mount.....	336	Battery Powered Digital Weight Indicator	
Leveling Pad Stems.....	336	<b>SURVIVOR® 390HE</b> .....	364
RoughDeck® Scale Base.....	337	Hostile Environment Digital Weight Indicators	
Summit® 3000 Scale Base.....	337	<b>420 Plus</b> .....	365
Complete Custom Cable Services.....	338	HMI Digital Weight Indicator	
EL147RP Plus.....	339	<b>SURVIVOR® 420HE</b> .....	367
Rodent Protection Cables		Hostile Environment Digital Weight Indicators	
Hostile Environment Load Cell Cable.....	340	<b>480/480 Plus Legend™ Series</b> .....	368
Standard Load Cell Cable.....	340	Digital Weight Indicator	
EL147IS Hazardous Environment Blue Jacket Cable.....	341	<b>482/482 Plus Legend™ Series</b> .....	370
EL144 Communications Cable.....	341	Digital Weight Indicator	
BCD Cable.....	341	<b>IQ plus® 590-DC</b> .....	372
Fiber Optic Cable.....	342	Battery Powered Digital Weight Indicator	
SURVIVOR® EL620HE High Temperature Cable.....	342	<b>720i™</b> .....	374
SURVIVOR® Cable Armor.....	342	Programmable HMI Indicator/Controller	
EL148 HE Replacement Mettler Toledo® Power Cell® Cable.....	343	<b>820i®</b> .....	376
Load Cell Conduit Adapters.....	343	Programmable HMI Indicator/Controller	
Cord Grip Assemblies.....	343	<b>880/880 Plus Performance™ Series</b> .....	378
EL214 Cable Splicing Kit.....	344	Digital Weight Indicator/Controller	
EL214T Cable Splicing Kit.....	344	<b>920i®</b> .....	380
EL215 Cable Splicing Kit.....	344	Programmable HMI Indicator/Controller	
Flintec™ Load Cell Cable Replacement Kits.....	345	<b>920i® USB</b> .....	384
T-Grip Molding.....	347	Programmable HMI Indicator/Controller	
T-Strip Molding.....	347	<b>920i® User Programs</b> .....	386
Electronic Scale Tickets.....	348	<b>920i® FlexWeigh Systems</b> .....	387
Mechanical Scale Tickets.....	349	Fillers/Batchers	
Create Your Own Custom Ticket.....	349	<b>920i® FlexWeigh Systems</b> .....	389
Scale Veils.....	350	Bulkweighers	
Cables.....	351	<b>920i® FlexWeigh Systems</b> .....	391
		Flow Rate Controllers	
		<b>920i® FlexWeigh Systems</b> .....	393
		Hand Batching	
		<b>MSI-8000HD</b> .....	394
		Digital Weight Indicator	
		<b>CW-90</b> .....	395
		Checkweigher Indicator Only	
		<b>CW-90X</b> .....	397
		Checkweigher Indicator Only	
		<b>VIRTUi2®</b> .....	399
		PC-Based HMI for iQUBE2®	

<b>SCT-10</b> .....	<b>400</b>	<b>437 Bridgesensor</b> .....	<b>436</b>
Signal Conditioning Transmitter/Indicator		Signal Conditioner	
<b>SCT-20</b> .....	<b>401</b>	<b>463 Bridgesensor</b> .....	<b>437</b>
Signal Conditioning Transmitter/Indicator		Signal Conditioner	
<b>SCT-30</b> .....	<b>402</b>	<b>API 4058G - 441/442 Bridgesensors</b> .....	<b>438</b>
Signal Conditioning Transmitter/Indicator		Load Cell Signal Conditioners	
<b>Relays and Racks</b> .....	<b>403</b>	<b>Amphenol® RJF 544</b> .....	<b>440</b>
<b>Input and Output Components/ Grayhill and OPTO 22 Relays and Racks</b> .....	<b>404</b>	Harsh Environment Ethernet Connection System	
<b>Explosive Environment Equipment Policy</b> .....	<b>405</b>	<b>AbleCable®</b> .....	<b>441</b>
<b>Hazardous Area Classification</b> .....	<b>406</b>	RS 232/USB Serial Smart Cable Direct, Keyboard Input Direct	
<b>Explosive Environment Solutions</b> .....	<b>407</b>	<b>go-between</b> .....	<b>442</b>
<b>Hazardous Atmospheres</b> .....	<b>408</b>	Data Capture and Storage	
<b>320IS</b> .....	<b>409</b>	<b>In-Motion Weighing</b>	
Intrinsically Safe Digital Weight Indicator		<b>MotoWeigh® In-Motion Conveyor Scale and Checkweigher</b> .....	<b>444</b>
<b>320IS Plus</b> .....	<b>411</b>	<b>Junction Boxes/Simulators</b>	
Intrinsically Safe Digital Weight Indicator		<b>JB4SS</b> .....	<b>448</b>
<b>EL232 XPCD</b> .....	<b>413</b>	TuffSeal® Signal Trim Junction Box	
Explosion Proof Remote Serial Display		<b>JB4ES</b> .....	<b>449</b>
<b>Intrinsic Safety Barriers</b> .....	<b>414</b>	TuffSeal® Excitation Trim Junction Box	
<b>Profibus® DP Interface</b> .....	<b>416</b>	<b>JB4SP and JB4SPT</b> .....	<b>450</b>
720i/820i/920i		TuffSeal® Signal Trim Junction Box	
<b>Profibus® DP Interface</b> .....	<b>417</b>	<b>JB4EP and JB4EPT</b> .....	<b>451</b>
880		TuffSeal® Excitation Trim Junction Box	
<b>ProfiNet® Interface</b> .....	<b>418</b>	<b>EL204</b> .....	<b>452</b>
880		Signal Trim Junction Box	
<b>Allen-Bradley® Remote I/O</b> .....	<b>419</b>	<b>EL504</b> .....	<b>453</b>
720i™/820i®/920i®		Signal Trim Junction Box	
<b>DeviceNet™ Interface</b> .....	<b>420</b>	<b>JB8SP</b> .....	<b>454</b>
720i™/820i®/920i®		TuffSeal® Signal Trim Junction Box	
<b>DeviceNet™ Interface</b> .....	<b>421</b>	<b>JB8SPT</b> .....	<b>455</b>
880		TuffSeal® Signal Trim Junction Box	
<b>ControlNet™ Interface</b> .....	<b>422</b>	<b>EL304A</b> .....	<b>456</b>
820i®/920i®		Signal Trim Junction Box	
<b>MODBUS-TCP® Interface</b> .....	<b>423</b>	<b>JB1010</b> .....	<b>457</b>
880		Signal/Excitation Trim Junction Box with Transient Protection	
<b>EtherNet/IP® Protocol Card for AB PLC</b> .....	<b>424</b>	<b>JB1010ST</b> .....	<b>458</b>
720i™/820i®/920i®		Signal Trim Junction Box with Transient Protection	
<b>EtherNet/IP® for AB PLC</b> .....	<b>425</b>	<b>Replacement Junction Boxes, Boards or Components</b> .....	<b>459</b>
880		<b>iQUBE 2®</b> .....	<b>460</b>
<b>Ethernet TCP/IP Interface</b> .....	<b>426</b>	Digital Diagnostic Junction Box	
720i™/820i®/920i®		<b>EL168</b> .....	<b>462</b>
<b>TranSend®</b> .....	<b>427</b>	1-Cell Junction Box	
Wireless Load Cell Interface System		<b>TP75 DC</b> .....	<b>463</b>
<b>SendIt® Wireless Load Cell Interface System</b> .....	<b>429</b>	Transient Protection	
<b>ConnexLink™</b> .....	<b>430</b>	<b>UJB3T6 DC</b> .....	<b>464</b>
Wireless Radio 900 MHz Transceivers		Transient Protection	
<b>Industrial Broadband Wireless Ethernet</b> .....	<b>431</b>	<b>TP232 RS-232</b> .....	<b>465</b>
<b>XTend-PKG™ RF Modems</b> .....	<b>432</b>	High Energy Serial Protection	
<b>QWERTY Style Keyboards and Aluminum Keypads</b> .....	<b>433</b>	<b>Ranger 1</b> .....	<b>466</b>
<b>X-Purge</b> .....	<b>434</b>	<b>Ranger 3</b> .....	<b>466</b>
<b>Tripp-Lite USB to Serial Converters</b> .....	<b>435</b>	<b>Transducer Simulator 4</b> .....	<b>467</b>
Serial Adapters		<b>Ranger 5</b> .....	<b>467</b>
		<b>Ranger 7</b> .....	<b>468</b>

<b>Load Cells/Weigh Modules</b>	
<b>SURVIVOR Paramounts® HE</b> .....	<b>472</b>
Medium-Capacity Weigh Module Systems	
<b>RL 1700HE</b> .....	<b>474</b>
Light-to Medium-Capacity Weigh Modules	
<b>RL1600 HE</b> .....	<b>476</b>
Medium-Capacity Weigh Modules	
<b>RL1855 HE</b> .....	<b>478</b>
Medium-Capacity Weigh Modules	
<b>RL2100 HE</b> .....	<b>480</b>
Heavy-Capacity Weigh Modules	
<b>ITCM</b> .....	<b>482</b>
Isolated Tension Cell Modules	
<b>ITCM SS</b> .....	<b>484</b>
Stainless Steel Isolated Tension Cell Modules	
<b>ITCM HE</b> .....	<b>486</b>
Stainless Steel, Welded-Seal NTEP-Approved Isolated Tension Cell Modules	
<b>RL50210 TA</b> .....	<b>488</b>
50-500lb Capacity Mini Tank Weighing Module	
<b>RL50210 TA</b> .....	<b>490</b>
1000-2500lb Capacity Mini Tank Weighing Module	
<b>Paramounts® EP</b> .....	<b>492</b>
Environmentally Protected Mild Steel, Light-to Medium-Capacity Tank Weighing Systems	
<b>Paramounts® HS</b> .....	<b>494</b>
Hermetically Sealed Load Cells Mild Steel, Light to-Medium Capacity Tank Weighing Systems	
<b>RLBTM Mild/Stainless</b> .....	<b>496</b>
Steel Weigh Modules	
<b>RL1800 Series</b> .....	<b>498</b>
Mild Steel/Stainless Steel Weigh Modules	
<b>RL1900 Series</b> .....	<b>500</b>
Stainless Steel Weigh Modules	
<b>RLTM</b> .....	<b>502</b>
Stainless Steel Tank Weigh Module	
<b>RL9000TWM Series</b> .....	<b>504</b>
Tank, Hopper and Vessel Weighing Assembly	
<b>RL9000TWM-HT</b> .....	<b>508</b>
Tank, Hopper and Vessel Weighing Module	
<b>RL2200 Series</b> .....	<b>510</b>
Tank, Hopper and Vessel Weighing Assembly	
<b>RL2200 SS Series</b> .....	<b>512</b>
Stainless Steel, Tank, Hopper and Vessel Weighing Assembly	
<b>EZ Mount 1</b> .....	<b>514</b>
Mild Steel	
<b>EZ Mount 1</b> .....	<b>516</b>
Stainless Steel	
<b>EZ Mount 1 HE</b> .....	<b>518</b>
Stainless Steel, Hermetically Sealed	
<b>RL1600 Series</b> .....	<b>520</b>
Cast Iron	
<b>RL1600 Series</b> .....	<b>522</b>
Mild Steel	
<b>RL1600 Series</b> .....	<b>524</b>
Stainless Steel	
<b>MVS Mount/MVS</b> .....	<b>526</b>
Conversion Kit	
<b>TSA Truck Scale Assembly</b> .....	<b>528</b>
Rice Lake Weighing Systems	
<b>Translink™ Parallel Link Truck Scale Assembly</b> .....	<b>530</b>
Rice Lake Weighing Systems	
<b>Motor Truck Scale Electronic Conversion Kit</b> .....	<b>532</b>
Rice Lake Weighing Systems	
<b>MagnaMount®</b> .....	<b>534</b>
Tank, Truck and Railroad Track Assembly	
<b>Mettler Toledo™ DigiTOL® Retrofit Kit</b> .....	<b>536</b>
Stainless Steel, Rice Lake Weighing Systems/Flintec	
<b>Electronic Floor Scale Underdeck Kits</b> .....	<b>538</b>
<b>RL20000</b> .....	<b>539</b>
S-Beam	
<b>RL20000 SS</b> .....	<b>541</b>
S-Beam	
<b>RL20000 ST</b> .....	<b>543</b>
S-Beam	
<b>RL20001</b> .....	<b>544</b>
S-Beam	
<b>RL20001 HE</b> .....	<b>545</b>
S-Beam	
<b>RLETS</b> .....	<b>546</b>
S-Beam	
<b>RL30000</b> .....	<b>547</b>
Single-Ended Beam	
<b>RL30002 Thru Hole</b> .....	<b>548</b>
Single-Ended Beam	
<b>RLH35</b> .....	<b>549</b>
Single-Ended Beam	
<b>RL39123</b> .....	<b>550</b>
Single-Ended Beam	
<b>RL30745</b> .....	<b>551</b>
Single-Ended Beam	
<b>RIBC</b> .....	<b>552</b>
Single-Ended Beam	
<b>RL35023</b> .....	<b>553</b>
Single-Ended Beam	
<b>RL35023S</b> .....	<b>554</b>
Single-Ended Beam	
<b>RL35083</b> .....	<b>555</b>
Single-Ended Beam	
<b>RL35082</b> .....	<b>556</b>
Single-Ended Beam	
<b>RLETB</b> .....	<b>557</b>
Single-Ended Beam	
<b>RLHTO</b> .....	<b>558</b>
Single-Ended Beam	
<b>RLSSB</b> .....	<b>559</b>
Single-Ended Beam	
<b>RLSB250/RLSB250T</b> .....	<b>560</b>
Single-Ended Beam	
<b>RLSB2L</b> .....	<b>561</b>
Single-Ended Beam	
<b>RL50210</b> .....	<b>562</b>
Single-Ended Beam	
<b>RL50210SS</b> .....	<b>563</b>
Single-Ended Beam	
<b>RL60040SST</b> .....	<b>564</b>
Single-Ended Beam	
<b>RL40BBS</b> .....	<b>565</b>
Single-Ended Beam	
<b>RLHBB</b> .....	<b>566</b>
Single-Ended Beam	
<b>RL32011WB-L</b> .....	<b>567</b>
Single-Ended Beam	

<b>RL32011WB-T</b> .....	<b>568</b>	<b>RL1385</b> .....	<b>599</b>
Single-Ended Beam		Single-Point	
<b>RL70000</b> .....	<b>569</b>	<b>RL1260</b> .....	<b>600</b>
Double-Ended Beam		Single Point	
<b>RL70000 SS</b> .....	<b>570</b>	<b>RL1250</b> .....	<b>601</b>
Double-Ended Beam		Potted Single Point	
<b>RL71000 HE</b> .....	<b>571</b>	<b>RLFLS</b> .....	<b>602</b>
Double-Ended Beam		Potted Single Point	
<b>RL72010MH</b> .....	<b>572</b>	<b>RLBLP</b> .....	<b>603</b>
Double-Ended Beam		Planar Beam	
<b>RL75016</b> .....	<b>573</b>	<b>RL2010</b> .....	<b>604</b>
Double-Ended Beam		Tension Link	
<b>RL75016 SS</b> .....	<b>574</b>	<b>Medical Scales</b>	
Double-Ended Beam		<b>Personal Home Health</b> .....	<b>606</b>
<b>RL75016 WHE</b> .....	<b>575</b>	<b>Certified Fitness Scale</b> .....	<b>608</b>
Double-Ended Beam		<b>Mechanical Physician Scale</b> .....	<b>609</b>
<b>RL75058</b> .....	<b>576</b>	<b>Digital Physician Scale</b> .....	<b>613</b>
Double-Ended Beam		Eye Level	
<b>RL75060S</b> .....	<b>577</b>	<b>Digital Physician Scale</b> .....	<b>614</b>
Double-Ended Beam		Waist Level	
<b>RL75223</b> .....	<b>578</b>	<b>Mechanical Baby Scale</b> .....	<b>616</b>
Double-Ended Beam		<b>Digital Baby/Pediatric Scales</b> .....	<b>618</b>
<b>RLDB50000S</b> .....	<b>579</b>	<b>Adult and Child Scale</b> .....	<b>619</b>
Double-Ended Beam		<b>Digital Baby/Pediatric Scale</b> .....	<b>620</b>
<b>RL75040</b> .....	<b>580</b>	<b>Neonatal Scale</b> .....	<b>622</b>
Double-Ended Beam		<b>Bariatric Scales</b> .....	<b>623</b>
<b>RLCSP1</b> .....	<b>581</b>	<b>Mechanical Chair Scale</b> .....	<b>625</b>
Compression Canister		<b>Digital Chair Scales</b> .....	<b>627</b>
<b>RLSCA-50K</b> .....	<b>582</b>	<b>Wireless Wheelchair Scale</b> .....	<b>628</b>
Rocker Column		<b>Wheelchair Scale</b> .....	<b>629</b>
<b>RL75114-50K</b> .....	<b>583</b>	<b>Wheelchair Scale</b> .....	<b>634</b>
Rocker Column		Single Ramp with Wheel Stop	
<b>RL8C2P1SS</b> .....	<b>584</b>	<b>Wheelchair Scale</b> .....	<b>635</b>
Compression Canister		Dual Ramp	
<b>RL90000</b> .....	<b>585</b>	<b>Wheelchair Scale</b> .....	<b>638</b>
Compression* Disk		Pit Frame Concrete Details	
<b>RLPC6</b> .....	<b>586</b>	<b>Wireless Bed Scale</b> .....	<b>639</b>
Single Point		<b>Dietary Scale</b> .....	<b>640</b>
<b>RLPWM15HE</b> .....	<b>587</b>	<b>Body Composition Analyzer</b> .....	<b>641</b>
Single Point		<b>Monorail Scales</b>	
<b>RLPWM15</b> .....	<b>588</b>	<b>MS200 and MS202</b> .....	<b>646</b>
Single Point		Portable and Permanent Monorail Scales	
<b>RLPCBC-60</b> .....	<b>589</b>	<b>Onboard Weighing</b>	
Single Point		<b>Precision Loads</b> .....	<b>648</b>
<b>RL1521A</b> .....	<b>590</b>	Semi Trailer Kits	
Single Point		<b>Precision Loads</b> .....	<b>649</b>
<b>RL1010</b> .....	<b>591</b>	Straight Truck Kits	
Potted and Unpotted Single Point		<b>Precision Loads</b> .....	<b>650</b>
<b>RLSP4</b> .....	<b>592</b>	Replacement/SVC Parts	
Single Point		<b>TradeRoute™ HL Series</b> .....	<b>652</b>
<b>RLPWM12</b> .....	<b>593</b>	Legal for Trade Onboard Weighing System	
Single Point		<b>Loadrunner™ Onboard</b>	
<b>RLPWM16</b> .....	<b>594</b>	<b>Weighing Systems</b> .....	<b>655</b>
Single Point		Roll-Off Systems Kit	
<b>RL1042</b> .....	<b>595</b>	<b>Loadrunner™ Onboard</b>	
Single Point		<b>Weighing Systems</b> .....	<b>656</b>
<b>RL1040</b> .....	<b>596</b>	Dump Truck Systems Kit	
Potted and Unpotted Single Point			
<b>RL1140</b> .....	<b>597</b>		
Potted Single Point			
<b>RL1380</b> .....	<b>598</b>		
Single Point			

**Pipe Lever Scales**

Pipe Lever.....	658
-----------------	-----

**Portable Vehicle Scales**

Intercomp PT300™ Wheel Load Scale.....	662
Intercomp PT300™ RFX/PT300DW™ RFX Solar Powered Wheel Load Scale.....	663

**Power Conditioning**

Transient Protection AC, DC, Series and Parallel.....	668
TP232 RS-232.....	669
Tripp-Lite DNET1.....	670
LCP-1 DC Transient Protection.....	671
UJB3T6 DC Transient Protection.....	672
TP75 DC Transient Protection.....	673
ISOBLOK® AC Transient Protector.....	674
ISOBAR® AC Transient Protector.....	675
EL226 AC Transient Protector.....	676
EL225-4.....	677
Sola MCR Series.....	678
Tripp-Lite PV Series.....	679
LC1200.....	680
Sola S1K/S3K Uninterruptible Power System.....	681
Liebert PSP/PSA Uninterruptible Power Supply.....	682
Eaton 3S/5S Uninterruptible Power Supply.....	683

**Precision Industrial Weighing**

Sartorius® Intec Midrics Series Complete Scale.....	686
Sartorius® Intec Midrics 2 Series Midrics/Combics System.....	687
Sartorius® Intec Combics 2 Complete Scale.....	688
Sartorius® Intec Signum Series Complete Scale.....	689
Sartorius® Intec Midrics® 1 and 2 Series.....	690
Sartorius® Intec Combics 1 Digital Weight Indicators.....	691
Sartorius® Intec Combics 2 Digital Weight Indicators.....	692
Sartorius® Intec Combics 3 Digital Weight Indicators.....	693
Sartorius® Intec Combics Bench and Floor Platforms.....	694
Sartorius® Intec IF Series Painted Steel Platforms.....	696

Sartorius® Intec IF Series.....	698
Sartorius® Intec IS Series.....	701
Sartorius® Intec Signum EX Supreme Explosion Proof Bench Scale.....	703
Sartorius® Intec Combics 2 EX Explosion Proof Digital Weight Indicators.....	704
Sartorius® Intec Combics Explosion Proof Bench and Floor Platforms.....	705
Sartorius® Intec IF Series Explosion Proof Weighing Platforms.....	707
Sartorius® Intec IS-X Explosion Proof Scales.....	710
Sartorius® Intec PR6201 Zinc-Plated Steel Star Mount Kits.....	711
Sartorius® Intec PR6201 Stainless Steel Star Mount Kits.....	712
Sartorius® Intec PR6202 Hygienic Weigh Module Kits.....	713
Sartorius® Intec Contego-Hygienic Weigh Module Kits Lateral Cable Outlet.....	714
Sartorius® Intec Contego-Hygienic Weigh Module Kits Top Cable Outlet.....	715
Sartorius® Intec PR5220 Ethernet Transmitter.....	716
Sartorius® Intec PR5230 Fieldbus Transmitter.....	717
Sartorius® Intec PR5610-Pro-X5 System Controller.....	718

**Printers**

Rice Lake TicketPress™ Ticket Printer.....	720
Rice Lake SURVIVOR® SST3® Washdown Label Printer.....	722
Rice Lake GUARDIAN™ Steel Printer Enclosures.....	724
Rice Lake GUARDIAN G-2™ Steel Printer Enclosures.....	724
Rice Lake POLY GUARD Clear Printer Enclosures.....	725
Datamax-O'Neil microFlash™ 2Te Portable Printer.....	726
Datamax-O'Neil® E-Class III.....	728
Datamax-O'Neil® M-4206 Mark II/M-4210 Mark II.....	730
Datamax-O'Neil® I-4212e Mark II Direct Thermal Printer.....	732
Datamax-O'Neil® H-4212 / H-4310 Direct Thermal/Thermal Transfer Label Printer.....	734
Datamax-O'Neil® DMXREW1 Label Rewinder/Unwinder.....	736
EPSON® TM-T88V POS Printer.....	737
EPSON® TM-U220 Tape Printer.....	738
EPSON® TM-U295 Ticket Printer.....	740
EPSON® TM-U590 Ticket Printer.....	742

<b>EPSON® EU-T482 Series</b> .....	<b>744</b>
Thermal Kiosk Printer	
<b>GoDEX® DT2/DT4/G500</b> .....	<b>745</b>
Label Printer	
<b>Okidata 186 Turbo</b> .....	<b>747</b>
Microline Printers	
<b>Okidata 320/390/420 Turbo</b> .....	<b>748</b>
Microline Printers	
<b>Printek M1P400si</b> .....	<b>750</b>
Mobile Printer	
<b>Star Nippon® NP-211/NP-2511/NP-3511</b>	<b>751</b>
Thermal Kiosk Printer	
<b>Star® Micronics SP298</b> .....	<b>752</b>
Dot Matrix Ticket Printer	
<b>Star® SP512/SP542/SP712/SP742</b> .....	<b>754</b>
Dot Matrix Printers	
<b>Star® DP8340</b> .....	<b>756</b>
Dot Matrix Tape Printer	
<b>Star® TSP 847</b> .....	<b>758</b>
Receipt Thermal Printer	
<b>Star® TSP654II/TSP743 II</b> .....	<b>759</b>
Direct Thermal Printers	
<b>Zebra® LP/TLP 2824 Plus</b> .....	<b>761</b>
Thermal Printer	
<b>Zebra® GK Series</b> .....	<b>762</b>
Label Printer	
<b>Zebra® RW 420/RW 220</b> .....	<b>764</b>
Thermal Portable Printer	
<b>WinWedge® TAL Software</b> .....	<b>766</b>
Wedge Software	
<b>DTL</b> .....	<b>767</b>
Direct Thermal Label	
<b>DTL Plus/DTT/DTL-SYN</b> .....	<b>768</b>
<b>TTL-RFID Labels/TTL</b> .....	<b>769</b>
<b>Fantastock Thermal Transfer Label</b> .....	<b>770</b>
<b>TTT Standard Tag</b> .....	<b>770</b>
<b>SDR Super Durable Ribbon</b> .....	<b>770</b>
<b>MaxWax™ GPR</b> .....	<b>771</b>
General-Purpose Ribbon	
<b>Tape and Ticket Printer</b>	
<b>Impact Ribbons</b> .....	<b>772</b>
<b>Tape Printer Paper Supplies</b> .....	<b>773</b>
<b>Electronic Scale Tickets</b> .....	<b>774</b>
<b>Mechanical Scale Tickets</b> .....	<b>775</b>
<b>Replacement Print Heads</b> .....	<b>776</b>
<b>Printer Cables</b> .....	<b>777</b>
<b>Scale Veils</b> .....	<b>778</b>

## Remote Displays/Scoreboards

<b>SURVIVOR® LaserLight® Series</b> .....	<b>780</b>
4in, 4in Stop/Go, 6in Remote Display	
<b>SURVIVOR® LaserLight® M-Series</b> .....	<b>782</b>
Messaging Remote Displays	
<b>LaserLT RD-1550</b> .....	<b>784</b>
1.5in LED Remote Display	
<b>RD-232</b> .....	<b>786</b>
0.8in LED Remote Display	
<b>RD-300</b> .....	<b>788</b>
1.0in LCD Remote Display	

## Retail

<b>Rice Lake RS-130</b> .....	<b>792</b>
Battery-Operated Price Computing Scale	
<b>Ishida Astra</b> .....	<b>793</b>
Price Computing Scale with Printer	
<b>Ishida Astra Standard Label Formats</b> .....	<b>795</b>
<b>MajorSlice™ 300M</b> .....	<b>796</b>
Manual Slicer	
<b>Intruder™ Cut-Resistant Glove</b> .....	<b>797</b>
<b>QuikSharp™</b> .....	<b>797</b>

## Scanners

<b>Datalogic® QuickScan® QD2100</b> .....	<b>800</b>
Linear Imager Handheld Scanner	
<b>Datalogic® PowerScan® PD7100 Series and 7000 2D</b> .....	<b>801</b>
<b>Datalogic® PowerScan® RF PM8300 Series</b> .....	<b>802</b>
<b>Motorola® DS457</b> .....	<b>803</b>

## Software

<b>VIRTUi2®</b> .....	<b>806</b>
PC-Based HMI for iQUBE2®	
<b>Interchange</b> .....	<b>807</b>
920i® Database Management Software	
<b>OnTrak™</b> .....	<b>808</b>
Truck Data Management Software	
<b>TransAct® LE/TransAct®/TransAct® Plus</b> .....	<b>810</b>
Truck Data Management Software	
<b>CRS™ Certificate Retrieval System</b> .....	<b>812</b>
Version 3	
<b>TRACER®</b> .....	<b>813</b>
<b>WeighVault®</b> .....	<b>814</b>
<b>WinWedge® TAL Software</b> .....	<b>815</b>
Bar Code Label Software	

<b>Test Weights</b>	
<b>Weight and Calibration Specifications</b>	<b>818</b>
<b>CAST IRON - NIST, ASTM and OIML</b>	<b>820</b>
<b>Cast Iron</b>	<b>821</b>
Grip-handle and Nesting Slab Weights	
Grip-handle Weights	
Slotted Interlocking and Hanger Weights	
Counterpoise and Hanger Weights	
<b>Avoirdupois</b>	<b>825</b>
Counterpoise and Hanger Weights	
<b>STAINLESS STEEL - NIST</b>	<b>826</b>
<b>Metric Individual Weights</b>	<b>827</b>
<b>Avoirdupois Individual Weights</b>	<b>828</b>
<b>Metric Sets</b>	<b>829</b>
Range: 5 and 50 g	
Range: 100 g	
Range: 500 g	
Range: 1 kg	
Range: 2 kg	
Range: 5 kg	
<b>Avoirdupois Set</b>	<b>835</b>
Range: 4 oz	
Range: 1 lb	
Range: 2 lb	
Range: 5 lb	
Range: 5 lb	
Range: 10 lb	
Range: 10 lb	
<b>SPECIALTY WEIGHTS - NIST</b>	<b>842</b>
<b>Metric Cube and Ring Weights; Avoirdupois Ring Weights</b>	<b>843</b>
<b>Avoirdupois Slotted Weights and Troy Cylindrical/Leaf Weights</b>	<b>844</b>
<b>Penny Cylindrical, Leaf, Grain and Lift Truck Weights</b>	<b>845</b>
<b>Specialty Weights/Cube Weights Sets</b>	<b>846</b>
<b>Avoirdupois and Metric Individual Hook Weights</b>	<b>847</b>
<b>Avoirdupois and Metric Individual Hangers and Slotted Weights</b>	<b>848</b>
<b>STAINLESS STEEL - ASTM</b>	<b>849</b>
<b>Metric Kits</b>	<b>850</b>
<b>Metric Individual Weights</b>	<b>851</b>
<b>Avoirdupois Kits</b>	<b>852</b>
<b>Avoirdupois Individual Weights</b>	<b>853</b>
<b>PRECISION LABORATORY - ASTM</b>	<b>854</b>
<b>Metric Kits</b>	<b>855</b>
<b>Metric Individual Weights</b>	<b>856</b>
<b>Avoirdupois Kits</b>	<b>861</b>
<b>Avoirdupois Individual Weights</b>	<b>864</b>
<b>Essential Weights</b>	<b>865</b>
<b>Metric Sets</b>	<b>866</b>
Range: 500 mg	
Range: 500 mg	
Range: 20 g	
Range: 20 g	
Range: 50 g	
Range: 50 g	
Range: 100 g	
Range: 100 g	
Range: 200 g	
Range: 200 g	
Range: 300 g and 500 g	
Range: 300 g and 500 g	
Range: 1 kg	
Range: 1 kg	
Range: 2 kg	
Range: 2 kg	
Range: 3 kg and 5 kg	
Range: 3 kg and 5 kg	
Range: 10 kg	
Range: 10 kg	
Range: 20 kg and 25 kg	
Range: 20 kg and 25 kg	
<b>Avoirdupois Sets</b>	<b>888</b>
Range: 50 lb through 2 lb	
Range: 50 lb through 2 lb	
<b>STAINLESS STEEL - OIML</b>	<b>890</b>
<b>Metric Kits</b>	<b>891</b>
<b>Metric Kits and Weights</b>	<b>892</b>
<b>Metric Sets</b>	<b>893</b>
Range: 500 mg-50 g	
Range: 100 g	
Range: 200 g	
Range: 200 g	
Range: 500 g	
Range: 500 g	
Range: 1 kg	
Range: 1 kg	
Range: 2 kg	
Range: 2 kg	
Range: 5 kg	
Range: 5 kg	
Range: 10 kg	
Range: 10 kg	
Range: 20 kg	
Range: 20 kg	
<b>Sealing Plugs</b>	<b>909</b>
<b>Gloves/Transfer Equipment</b>	<b>910</b>
<b>Cases</b>	<b>911</b>
<b>Transfer Cart/Touch-Up Paint/Canvas Dust Covers</b>	<b>913</b>
<b>Discontinued Products</b>	<b>914</b>
<b>Truck/Rail Scales</b>	
<b>SURVIVOR® Truck, Rail and Livestock Scales</b>	<b>916</b>
<b>RailBoss™</b>	<b>917</b>
Full Draft and Double Draft	
<b>RoughDeck® AX</b>	<b>919</b>
Axle Scale	
<b>AX3040</b>	<b>920</b>
Axle Scale	



# Shipping Information

FREIGHT SERVICES OFFERED	"SMALL PACK"	LTL	TRUCK LOAD
Nationwide Same Day Service	Y*	Y*	N
Same Day, Counter to Counter***	Y	N	N
Next Day (AM)	Y	Y**	Y**
Next Day (END OF DAY)	Y	Y**	Y**
2 Day	Y	Y	Y
3 Day	Y	Y	Y
Ground	Y	Y	Y
Canada	Y	Y	Y
Mexico	Y	Y	Y
Express Freight (Air-over 150 lb)***	Y	Y	N
International (Sea)	Y	Y	Y
International (Air)	Y	Y	N

\* Subject to cost/distance

\*\* Subject to distance

\*\*\* Subject to flight availability and proximity of nearest airport

## Same Day Services

These services do not carry the same service guarantees that standard delivery schedules do and are subject to availability

## Small Parcel Services

We ship with internationally recognized parcel carriers based on delivery time and services offered.

## Determining Dimensional Weigh for Small Parcel Shipments for Air (& Ground 2015 →)

When shipping via air services, couriers require that the shipping weight be determined by the greater of the actual weight of the boxed product or its dimensional shipping weight. The formula for calculating dimensional shipping weight is as follows:  
 $L \times W \times H / 166$  for domestic air shipments and  $L \times W \times H / 139$  for international air shipments. RLWS takes the added precaution of double boxing some of our electronic products and balances. This may result in dimensional weight charges by the carrier when shipping by air. Even with this added precaution, we suggest that you always ship high precision and fragile products via air service.

## Less Than Truck Load (LTL)

Full service LTL coverage for the Continental United States, Puerto Rico, Canada and Mexico.

Note: A standard LTL delivery is considered to be one that ships from either a company or partner dock to arrival at a standard commercial address with disposition of the goods at the rear of the truck to enable off loading by material handling equipment provided by the consignee at either ground level or via loading dock. Allied to this, the freight in question should be pelletized and secured in a way to facilitate the safe handling of the freight with no one dimension over 7'6".

Any LTL delivery falling outside of this criteria may well accrue accessorial charges levied by the carrier in line with their tariff rules. It is recommended that any potential accessorial cost are discussed at the time of order placement so that these costs can be billed appropriately at the time of shipment. If this is not the case, RLWS reserves the right to charge the customer retrospectively for any accessorial costs incurred during the delivery process.

### Accessorial charges include, but are not limited to the following:

- Lift gate: \$100.00
- Call for appointment: \$40.00
- Guaranteed delivery: Day \$45.00, 10:30 a.m. (where available) \$100.00
- Inside delivery: \$100.00 **NOTE: To inside of first threshold crossed only**
- High cost delivery areas: Excessive length, government sites, and mines, re-delivery, re-consignment, residential and restricted access shipments

## Full Truckload

Various truckload providers that give us the ability to ship to the contiguous United States, Alaska, Canada and Mexico

## Forwarders (International Freight)

We can provide service through a forwarder of our choice, or select one of your preferred forwarders.

**Air Freight:** All of our forwarders are internationally recognized brands

**Ocean Freight:** All of our forwarders are internationally recognized brands

**Overseas Ocean Freight:** Call for estimated delivery time.





# Signed Sealed Delivered... It's yours!

**On average, regardless of carrier, 2% of all freight is damaged in transit. Don't let the delivery person slip away. And don't get left holding the bag.**

Rice Lake merchandise is packaged carefully to arrive at your location on time, intact and in perfect working order. We don't ship damaged goods, and we work with many of the most reputable national carriers. But know this—anytime a package is sent, as many as 2 out of 100 will be mishandled. To be sure your business doesn't take the hit for someone else's mistake—INSPECT before you sign.

Whether or not the product itself has been damaged, remember—your signature accepts the delivery as is, releasing the carrier and supplier of all liability, unless you take action:

- Make note of any damage to the packaging, no matter how slight, including re-packaging, water damage, scratches to paint, etc. Take photos if possible to back up any necessary claims.
- Do not accept or sign for as “unchecked”—this is not an acceptable disclaimer.
- Where damage to contents is obvious, take photos and refuse the shipment.

Notify your supplier immediately with the claim number provided by the driver. Noting the condition of your delivery upon receipt is the only recourse when making a damage claim. Follow these steps and you'll get replacement merchandise faster, keep costs down and ensure the carrier is held responsible for their mistakes; not you, and not your supplier.

**RICE LAKE**<sup>®</sup>  
WEIGHING SYSTEMS

To be the best by every measure<sup>®</sup>

800-472-6703

[www.ricelake.com](http://www.ricelake.com)

# What's New

in your 2015  
Master Catalog...

## BALANCES

**Rice Lake TP Series**  
Expanded NTEP models ..... 56



**Ohaus Adventurer Pro®**  
Precision Balances ..... 115



**Sartorius Entris**  
Balance ..... 153



## BELT SCALES

**311M**  
Medium to Heavy Capacity  
Belt Scale ..... 162



**221DB**  
Medium to Heavy Capacity  
Belt Scale ..... 163



## DIMENSIONING

**iDimension™**  
**200/300 Series**  
3D Imaging System ..... 252



## FLOOR SCALES



**RL1200**  
Portable Beam Scale ..... 278

**RL1200EM**  
Electromechanical Portable  
Beam Scale ..... 279

## INDICATORS

**480/480 Plus Legend™ Series**  
Digital Weight Indicator ..... 368



**482/482 Plus Legend™ Series**  
Digital Weight Indicator ..... 370

**880/880 Plus Performance™ Series**  
Digital Weight Indicator/Controller ... 378



**TranSend™**  
Wireless Load Cell  
Interface System ..... 427

**SendIt™**  
Wireless Load Cell  
Interface System ..... 429



## MEDICAL

**Body Composition Analyzer**  
D1000-1, D1000-2, D1000-3 ..... 641



## TEST WEIGHT KIT



**Essential Weights**  
Precision Laboratory - ASTM ..... 865

## WEIGH MODULE

**RLTM**  
Stainless Steel Tank  
Weigh Module ..... 502



# Customer Service Contacts

At Rice Lake Weighing Systems we strive to give you the best customer service in the industry. You can depend on our knowledgeable staff to deliver decisive, courteous assistance when you need it most.

Customer Service Representative Hours (CST):  
Monday through Friday 6:30 AM to 6:30 PM; Saturday 8:00 AM to Noon

## United States and Canada Field Sales



**Michael Bordino**  
Southeast Region  
715-434-5079



**Tim Campbell**  
Great Lakes Region  
715-434-5067



**Jeff Canfield**  
Allegheny Region  
715-434-5081



**Chris Hanson**  
Midsouth Region  
715-434-5069



**Roger Kimber**  
Northwest Region  
715-434-5097



**Jim Lynch**  
Mid-Atlantic Region  
715-434-5077



**Don Martin**  
Southwest Region  
715-434-5134



**Bill Murphy**  
Heavy Capacity Sales  
715-434-5115



**Cal Schumacher**  
Midwest Region  
715-434-5430



**Scott Schumacher**  
Northeast Region  
715-434-5349



**Ian Scott**  
Eastern Canada Region  
715-434-5049



**Murray Stewart**  
Western Canada Region  
715-434-5194



**Martin Devilla**  
Rice Lake de Mexico  
715-434-5258



**Manuel Talancon**  
Latin America  
715-434-5041



**Jaap Oosterlee**  
Europe  
715-434-5816



**Jose Mathew**  
Middle East/Asia/Africa  
715-434-5048



**Duco Kroon**  
Europe  
715-434-5804



**Fred Slack**  
Eastern Europe  
715-434-5822

## Customer Relations



**Mark O. Johnson**  
Chief Executive Officer



**Mark Johnson, Jr.**  
President



**Steve Parkman**  
Chief Operating Officer



**John Hughes**  
Vice President of  
Business Development



**Tom Kowalski**  
Vice President of  
Technology



**Todd Backer**  
Vice President of  
Engineering and Innovation



**Scott Davis**  
Director of Electronic  
Engineering



**Dominic  
Hodkiewicz**  
Director of Manufacturing



**Patrick Ranfranz**  
Director of Marketing



**Walter Hendriks**  
Managing Director,  
Europe



**Joe Grell**  
Vice President Heavy  
Capacity



**Kevin Marshall**  
Logistics Manager



**Dick Shipman**  
Quality Manager



**Bruce Johnson**  
Customer Service  
Manager



**Guru Ganesh**  
Director, India Operations

## Inside Sales



**Deanna Stanley**  
Inside Sales Supervisor



**Terica Schamberger**  
Sales Referral Coordinator



**Janelle Alton**



**Andrew Burish**



**Linda Burmester**



**Becky Clausen**



**Dave Jalowitz**



**Karja Keller**



**Jennifer Krahenbuhl**



**Tricia Larson**



**Len Nicpon**



**Brittny Olson**



**Tom Peterson**



**Russ Schnacky**



**Rob Shofner**



**John Tennant**



**Lynnette Thompson**



**Kally Wagner**

## Sales Engineers



**Ben Fauske**  
Technical Sales Supervisor



**John Eisele**



**Doug Hagie**



**Darin Ides**



**Sharon Miller**



**Efrain Molinari**  
Habla Español



**Marvin Stodola**

## Technical Support



**Sam Brower**



**Chuck Crowley**



**Alan Dobrowolski**



**Joe Heinicke**



**Patrick Hillman**



**Mark Hopland**



**Preston Reed**



**Greg Stager**



**Scott Ross**



**Layne Siverling**



**Mark Ware**



**Don O'Connell**  
Retail



**Savannah Emerson**  
Retail

## Directors of Strategic Accounts



**Ann Crowley**  
Precision  
715-434-5466



**Steve Delaney**  
Livestock Scales  
715-434-5293



**Joe Giglio**  
Medical  
715-434-5068



**Thomas Kendall**  
Onboard Systems  
715-434-5177



**Jeff Malinowski**  
MMU Sales Director



**Jeff White**  
MMU Sales Associate

## Mobile Marketing Unit

# Customer Service Contacts Continued

## Repair Department



**Phil Stoerber**  
Electronic Assembly  
Repair Manager



**Diane Gagner**  
Warranty>Returns



**Lisa Maciosek**  
Warranty>Returns



**TOM AEBLY**



**Randee Bauch**



**Art Folstad**



**Les Karpel**



**Dale Koehler**



**Tracy Lavalieri**



**Landon Nielson**



**Dan Tronstad**

## MSI



**Tim Carroll**  
National Sales Manager



**Ron Wenzel**  
Vice President  
International Sales and  
Aviation Products



**Phil Gray**  
Director of Operations



**Dave Taylor**  
Director of Engineering



**Jim Norvid**  
Mechanical Engineering  
Manager

## Heavy Capacity Sales



**Karen Hansen**



**Eric Torrison**



**Tony Zillmer**



**Peter Allen**  
Export Customer  
Service Supervisor



**Connie Genatempo**  
International  
Sales Specialist



**Gloria Miranda**  
Habla Español



**Bobbie Stiver**  
Habla Español  
Parle Français

## International Region

## Financial Services



**Sandy Raby**  
Financial Services  
Manager



**Wendy Boese**



**Nicole Dostal**



**Marcia Fankhauser**



**Tammy Kline**



**Michelle  
Niederhauser**



**Angela Santillan**

## Receptionists



**Vivian Kroon**  
Europe



**Lynette Marshall**



**Kathleen Miller**



**Shannon Ullom**

# Trademarks

*The following product names, logos, brands and other trademarks featured or referred to within this publication are the property of their respective trademark holders.*

Access™	Intel®	Pioneer™	SUREFOOT™
Adventure Pro®	Interchange®	PowerCell®	Symbol®
Allen-Bradley®	Intercomp CS™	Powerware®	TekLynx®
Amphenol®	Intercomp PT300DW™	PreVent™	Toledo®
AstraLabel™	Intercomp PT300™	Prodigy Max™	Torque™
AstraLink™	IONMASTER™	Prodigy™	TRANSCORE®
AutoCal™	iPAQ™	Profibus®	Trooper®
Beldfoil®	ISOBAR®	ProPrinter®	Turck®
Bitstream®	ISOBLOK®	Quickbooks®	Valor®
Bluetooth®	JavaPOS™	QuickScan®	Voyager®
Cardinal®	LabelView™	QuikSharp™	Vulcan®
Cent-O-Gram®	LifeGuard™	R Stahl®	WinCT®
Centronics®	LoopTracker™	Ranger™	Windows®
Citizen®	Lotus™	Rapid Exchange®	WinWedge®
ConnexLink™	Maxi-Scoop™	Rockwell Automation®	Xscale®
ControlNet®	MaxWax™	Roman and Swiss™	XTend-PKG™
CRS™	Microline®	S4M™	Zebra®
Cubis®	Microsoft®	Sartorius®	ZigBee™
Datalogic QuickScan®	Midrics®	Satorious®	ZPL®
Datamax-O'Neil®	MIFARE®	Scout Pro®	
DeviceNet™	Mobile 5.0™	SI®	
Dial-O-Gram®	Motiontrap™	STAR®	
DIGI®	Motorola ColdFire®	The Crosby Group LLC	
Discovery™	MS-DOS™		
Dymo®	NatraSorb®		
EPL®	Novell®		
EPL2®	OHAUS®		
EPSON®	OKI®		
ESC/POS®	Pax®		
Excel™	pcANYWHERE®		
Explorer®	Peachtree®		
Fairbanks™			
Flintec™			
Genius®			
Hewlett-Packard™			
Howe™			
IBM®			
InCal™			

# Terms and Conditions

The terms “Buyer,” “Authorized Reseller,” and “Customer” as used herein, shall mean the party placing the purchase order with Rice Lake Weighing Systems. No contractual relationship between Rice Lake Weighing Systems and said party shall arise until such time as a purchase order has been accepted by Rice Lake Weighing Systems and such acceptance has been indicated on a written acknowledgment. Tenders which do not stipulate an acceptance period shall not be binding. Orders shall be subject to Rice Lake Weighing Systems’ standard terms and conditions as printed below, subject to correction for clerical errors.

These Sales Terms and Conditions shall be binding if declared applicable in the tender or in the order acknowledgement. Any conditions stipulated by the Buyer which are in contradiction to these Sales Terms and Conditions shall only be valid if expressly acknowledged by Rice Lake Weighing Systems in writing.

## 1. Prices

(a) Rice Lake Weighing Systems (RLWS) prices are net 30 days EX Works RLWS plant. Orders are subject to approval of our credit department with rights reserved to change or withdraw credit terms without notice and to terminate any orders when invoices for work done thereon have gone unpaid for 60 days.

(b) Prices do not include taxes of any kind by federal, state, municipality or other governmental authority, which RLWS may be required to collect or pay with respect to the sale or shipment of goods sold hereunder. Regardless of when any such taxes are determined or become payable, all taxes would be the responsibility of the Customer and would be in addition to the prices quoted hereon.

(c) This quotation is made upon the basis of the cost of materials and labor as of the date of this quotation. A change in such costs shall give RLWS the right to alter prices to reflect such changes in cost.

## 2. Shipment, Title, Risk of Loss

(a) All shipments are EX Works point of shipment. Title and risk of loss or damage passes to the Customer upon presentation of the goods to the Customer’s carrier at RLWS’s facility, except that title and risk of loss or damage as to Customer’s partially manufactured parts and raw materials delivered to RLWS, and as to jigs, fixtures and tools specially ordered for the Customer shall at all times remain with the Customer.

(b) RLWS does not carry fire insurance upon jigs, fixtures and tooling built by RLWS for Customers or supplied to RLWS by Customers, nor does RLWS carry insurance upon raw materials supplied to RLWS by Customers. Customers assume all risk of loss, damage or destruction of jigs, fixtures, tooling or raw materials belonging to the Customer in RLWS custody caused by fire, water, gas, acts of God, strikes, insurrection, riots or by acts of the civil or military authorities and whether or not such loss, damage or destruction was the result of our negligence or misconduct or that of our agents or employees. The Customer agrees to indemnify and hold RLWS harmless from all direct and consequential costs and damages resulting from such loss.

(c) Except as hereinabove stated, we agree to maintain all jigs, fixtures and tooling built by RLWS in working condition for their normal life only, except that our liability in this respect shall not extend more than one year after the completion of the most recent production order.

## 3. Quantity, Materials and Tolerances

(a) Unless dimensions are limited by a specific tolerance, it is understood that the production variations as published by RLWS will be acceptable.

(b) RLWS will not be responsible for color, thickness variations, or flaws in sheets or parts from which fabrications are made, nor for other material variations beyond our control.

(c) RLWS assumes no responsibility for loss or damage occurring by reason of delay or inability to deliver caused by fires, strikes, accidents, embargoes, car shortages, delays of carriers, insurrection, riots, acts of the civil or military authorities, nor will we assume responsibility for any reason whatever for damages of any kind on account of failure to deliver at the time specified. The Customer shall indemnify and hold RLWS harmless from all direct and consequential costs and damages resulting from such loss or delay.

(d) Unless otherwise specified, delivery of 10 percent more or less of completed parts than the quantity specified shall constitute fulfillment of this order and any excess not exceeding 10 percent shall be accepted and paid for by the Customer.

(e) In the event any raw material specified for incorporation into the product covered by this proposal shall become unavailable, RLWS shall notify the Customer and the Customer may direct RLWS to substitute available material for that originally specified, it being understood and agreed that the Customer shall assume any and all consequences resulting from such substitution.

## 4. Patents

If this quotation covers parts made specifically for the Customer, the Customer agrees to indemnify and hold RLWS harmless against any loss resulting from infringement of patents or trademarks, or from claims of such infringements and shall pay all legal and defense costs incurred by RLWS in the defense of such actions.

## 5. Software

Unless specifically otherwise stated, any and all software associated or part of any product sold, loaned on trial or demonstration to the Customer is to be considered proprietary to RLWS. The Customer agrees not to duplicate for distribution or to sell or distribute in any way without the prior written consent of RLWS.

## 6. Changes And Cancellation: Rejection, Claims

(a) Orders placed with RLWS are not subject to cancellation, change or reduction in amount, or suspension of deliveries except with RLWS’s consent and upon terms that indemnify RLWS against loss. Unless confirmed in writing, all verbal agreements are void.

(b) RLWS will not be responsible for changes in design, deliveries or other instructions, unless they are furnished in writing. The Customer agrees to pay for all tooling charges caused by changes in design or specifications.



# Terms and Conditions

(c) Samples submitted shall be deemed approved unless written rejection is received within two weeks of submission.

(d) Manufactured parts will be shipped and billed as they are produced.

(e) Claims for shortage or rejections for defects must be made within 10 days of receipt of goods. Credit will be rendered on such defective parts after we have had an opportunity to inspect them, provided they are returned to our factory, transportation charges prepaid, within 30 days, and provided they have not been altered or defaced in any way.

## 7. Tooling and Designing

(a) In consideration of the engineering service necessary in the designing of jigs, fixtures and tooling not being charged for, but being quoted on the basis of labor and material only, and not at their fair market value, such jigs, fixtures and tooling shall remain in our possession for at least one year. Thereafter, the Customer desiring delivery of such jigs, fixtures and tooling shall pay an engineering charge of 50 percent of the original price of said jigs, fixtures and tooling and accept same as is.

(b) When requested, we will submit suggestions concerning design and construction of parts, but we will not accept responsibility of liability for the practicability of these suggestions if adopted by the Customer.

## 8. Delivery and Adjustment to Price

(a) If the Customer requests that the goods be manufactured and shipped on a date (or dates) earlier than originally agreed to by RLWS and the Customer, and RLWS agrees to the earlier date (or dates), any increase in the cost of performance incurred by RLWS resulting from earlier manufacture and shipment will be included in an adjustment of the purchase price to be made by RLWS and will be paid by the Customer.

(b) Should shipments be held beyond scheduled date for convenience of the Customer, goods will be billed and charges will be made for warehousing, trucking, and other expenses incident to such delay. Reasonable and sufficient care is taken by RLWS in crating its goods. RLWS cannot be held responsible for breakage after having received "in good order" receipts from the transportation carrier. All claim for loss and damage must be made by the Customer to the carrier, but we will assist insofar as practical in securing satisfactory adjustment of such claims.

## 9. Payment and Liens

(a) All invoices shall be due and payable when submitted for payment in accordance with the revisions of RLWS terms. No withholding of funds, back charges or credits against amounts otherwise due to RLWS will be permitted unless specifically agreed to in writing by RLWS. Settlement of any amounts due Customer will be negotiated as separate items and not as offsets against amounts otherwise due to RLWS from the Customer for products sold hereunder.

(b) Any unpaid account for work done shall constitute a lien on any jigs, fixtures, manufactured parts, and raw materials in RLWS possession. In the event any account remains open and unpaid for 90 days, RLWS reserves the right to use the Customer's jigs and fixtures to make parts therefrom, and to sell or dispose of manufactured parts and raw materials.

(c) The Customer shall not assign or transfer any rights or obligations arising from this proposal, or monies payable thereunder, without the prior written consent of RLWS, and any such assignment or transfer made without such written consent shall be deemed null and void.

## 10. Additional Provisions

(a) Errors—Stenographic and clerical errors are subject to correction.

(b) These terms and conditions constitute the entire contract between the Customer and RLWS, transcending any oral arrangements or representations which may be inconsistent therewith.

(c) This quotation is made under and shall be governed by the laws of the state of Wisconsin.

## 11. Resale of Rice Lake Weighing Systems Products

In order to ensure compliance with the U.S. Export Administration Regulations we ask you to comply with the following:

(a) The Customer shall not export or re-export Rice Lake Weighing System products, either directly or indirectly, in contravention of any applicable law, statute or regulation and will first obtain any required licenses or authorizations from the relevant government authority when necessary as prescribed by law.

(b) The Customer confirms that it is familiar with and complies with the relevant national and international export control regulations and embargo regulations. The Customer furthermore confirms that it is in particular familiar with and complies with the U.S. Department of Commerce, Export Administration Regulations; U.S. Department of Treasury, OFAC Sanctions; the U.S. Department of Defense, ITAR requirements and the U.S. Department of State regulations.

(c) If deemed necessary, Rice Lake Weighing Systems, in individual cases may make further requests from the Customer for information required for export compliance.

(d) Should it be necessary for the Customer to obtain an export license from the appropriate authorities pursuant to the aforementioned regulations, the Customer shall apply for such a license autonomously and at their own expense.

**The foregoing warranties are exclusive and in lieu of all other express and implied warranties whatsoever, including but not limited to implied warranties of merchantability and fitness for a particular purpose. RLWS shall not be subject to any other obligations or liabilities whatsoever with respect to parts manufactured or supplied by RLWS or services rendered by it.**

**Anything herein to the contrary notwithstanding, RLWS shall not be liable for incidental and consequential damages, and in substitution for all remedies which the Customer may have under any applicable law. The Customer's sole and exclusive remedy against RLWS for any breach of warranty or any other breach relating to goods delivered pursuant hereto shall be for repair or replacement (at RLWS's option) of the goods or parts effected by such breach.**

# Warranty and Limitation of Liability

## Warranties

### Standard Product Limited Warranty

Rice Lake Weighing Systems (Rice Lake) warrants that all Rice Lake brand equipment and systems properly installed by an Authorized Reseller or original equipment manufacturer (OEM) will operate per written specifications as confirmed by the authorized reseller/OEM and accepted by Rice Lake. All systems and components are warranted against defects in materials and workmanship for one (1) year from the date of shipment from Rice Lake, unless otherwise stated in the product catalog or manual.

Rice Lake warrants that the equipment sold hereunder will conform to the current written specifications authorized by Rice Lake. Rice Lake warrants the equipment against faulty workmanship and defective materials. If any equipment fails

to conform to these warranties, **Rice Lake will, at its option, repair or replace such goods returned within the warranty period subject to the following conditions:**

- Upon discovery by the Customer of such nonconformity, Rice Lake will be given prompt written notice with a detailed explanation of the alleged deficiencies.
- Individual electronic components returned to Rice Lake for warranty purposes must be packaged to prevent electrostatic discharge (ESD) damage in shipment. Packaging requirements are listed in the publication, "Protecting Your Components From Static Damage in Shipment," available from the Rice Lake Equipment Return Department.
- Examination of such equipment by Rice Lake confirms that the non-conformity actually exists, and was not caused by accident, misuse, neglect, alteration, improper installation, improper repair, or improper testing. Rice Lake shall be the sole judge of all alleged nonconformities.
- Such equipment has not been modified, altered, or changed by any person other than Rice Lake or its duly authorized repair agents.
- Rice Lake will have a reasonable time to repair or replace the defective equipment. The Customer is responsible for shipping the product to Rice Lake. Rice Lake is responsible for shipping the product back to the Customer.
- In no event will Rice Lake be responsible for travel time or on-location repairs, including assembly or disassembly of equipment. Nor will Rice Lake be liable for the cost of any repairs made by others.
- On all intrinsically safe equipment, any field repair or modifications voids any and all warranties expressed or implied and void F.M. approval.
- Any loose hardware, screws, washers or non-ESD bags of hardware stored inside indicator will void warranty. This could cause harm to repair technician or damage CPU board.
- If just the board is sent in for repair, the serial number of the product the board is from should accompany the board.

**These warranties exclude all other warranties, expressed or implied, including without limitation warranties of merchantability or fitness for a particular purpose. Neither Rice Lake nor the authorized reseller will, in any event, be liable for incidental or consequential damages at the point of use.**

**Rice Lake and the Customer agree that Rice Lake's sole and**

**exclusive liability hereunder is limited to repair or replacement of such goods. In accepting this warranty, the Customer waives any and all other claims to warranty.**

**Should the seller be other than Rice Lake, the Customer agrees to look only to the seller for warranty claims.**

No terms, conditions, understanding, or agreements purporting to modify the terms of this warranty shall have any legal effect unless made in writing and signed by a corporate officer of Rice Lake and the Customer.

### Custom Software Limited Warranty

Rice Lake Weighing Systems (Rice Lake) warrants that (a) the software will perform in accordance with the specification and accompanying written endorsement by the Customer for a period of 90 days from the date of receipt; (b) any hardware accompanying the software will be free from defects in materials and workmanship under normal use and service for a period of one (1) year from the date of shipment from Rice Lake; and (c) the Customer should perform inspection and testing of software products prior to installation.

This limited warranty is void if failure of the software or hardware has resulted from accident, abuse, misapplication, or incorrect Customer specification. Any replacement software will be warranted for the remainder of the original warranty period or 30 days, whichever is longer.

If the software fails to conform to these warranties, Rice Lake will, at its option, repair or replace such goods returned within the warranty period subject to the following conditions:

- Upon discovery by the Customer of such nonconformity, Rice Lake will be given prompt written notice with a detailed explanation of the alleged deficiencies.
- Examination of software by Rice Lake confirms that the nonconformity exists, and was not caused by accident, misuse, neglect, alteration, improper installation, improper repair, improper testing, or incorrect Customer specification. Rice Lake shall be the sole judge of all alleged nonconformities.
- Rice Lake will have a reasonable time to repair or replace the software. The Customer is responsible for shipping charges both ways.
- In no event will Rice Lake be responsible for travel time or on-location repairs, including assembly or disassembly of equipment. Nor will Rice Lake be liable for the cost of any repairs made by others.

**These warranties exclude all other warranties, expressed or implied, including without limitation warranties of merchantability or fitness for a particular purpose. Neither Rice Lake nor the authorized reseller will, in any event, be liable for incidental or consequential damages at the point of use.**

**Rice Lake and Customer agree that Rice Lake's sole and exclusive liability hereunder is limited to repair or replacement of such goods. In accepting this warranty, the Customer waives any and all other claims to warranty.**

**Should the seller be other than Rice Lake, the Customer agrees to look only to the seller for warranty claims.**

No terms, conditions, understanding, or agreements purporting to modify the terms of this warranty shall have any legal effect unless made in writing and signed by a corporate officer of Rice Lake and the Customer.

# Warranty and Limitation of Liability

## Return Policies

Our commitment to our Customers states that if any standard product purchased from Rice Lake does not work, or if the incorrect product is shipped, **return it in its original shipping carton with all accessories in “like new” condition** for full credit or replacement within 30 days of purchase. **Electronic components returned to Rice Lake must be properly packaged to prevent electrostatic discharge (ESD) damage in shipment.** Packaging requirements are listed in the publication, “Protecting Your Components From Static Damage in Shipment,” available online or from our Returns Department. This policy and the 30-day limit also apply to any products drop-shipped directly from the manufacturer.

Please note that if an incorrect quantity of product was shipped, Rice Lake must be contacted within 10 days of the purchase. Upon notification, we will immediately correct the situation.

**A restocking charge will apply if equipment is not in like-new condition.** The restocking charge is directly proportional to the amount of time and material required to return the item to resalable condition—we will make every effort to do this quickly and economically. Equipment that has been abused and/or shows signs of excessive wear and cannot be reconditioned and resold will not be accepted for return or credit after excessive wear or has been modified.

### As Applied to Drop Shipments

All Rice Lake return guidelines apply to products drop-shipped directly from the manufacturer. If a perceived error occurs, Rice Lake will investigate to the best of our ability to determine if the error occurred prior to shipping, during shipping, or at the end user site. If our records and subsequent investigation indicate that the shipment was correct when it left our factory, our responsibility extends only to the authorized reseller, not their end user. Our standard product warranty notes that our coverage extends only to equipment and systems **properly installed by an authorized reseller.**

### Obtaining an RMA

A return authorization number (RMA) is required for all materials being returned to Rice Lake for credit. Flat rate repairs require purchase orders at time of RMA issuance.

When returning equipment for repair or warranty reimbursement consideration, these simple steps will help to expedite your request:

1. Call our Returns Department.
2. Please have your customer number and both the item description and problem for a repair.
3. Please have the original sales order or invoice number for items to be returned for credit or warranty. NOTE: See return policy
4. An RMA number will be given for eligible returns. This RMA number may also be faxed or emailed per your request.

## Return Shipments Outside United States for Repair, Warranty, Calibration or Other Services and Re-export.

### For shipment to the USA:

1. The commercial invoice must include the following statement:
  - a. “These goods are being returned for maintenance under”
    - i. Goods Made in the USA -- “HTS 9801.00.1012”
    - ii. Goods NOT made in the USA -- “HTS 9801.00.2500”
2. The commercial invoice must list items individually and include the fair market value of the item based on its present condition for customs purposes only.
3. Please reference original RLWS commercial invoice number and date item was purchased if applicable.
4. Please note that failure to follow these procedures may cause delay and will certainly incur extra charges that will NOT be absorbed by Rice Lake.

## Return Shipments Outside United States Other Than for Repair, or Service Work Not Being Returned.

### For shipment to the USA:

1. The commercial invoice must include the following statement:
  - i. Goods Made in the USA -- “HTS 9801.00.1045”
  - ii. Goods NOT made in the USA -- “HTS 9801.00.2500”
2. The commercial invoice must list items individually and include the fair market value of the item based on its present condition for customs purposes only.
3. Please reference original RLWS commercial invoice number and date item was purchased if applicable.
4. Please note that failure to follow these procedures may cause delay and possible reduction in your refund.
5. Please be advised that you may qualify for a refund of your duties and should contact your local customs authority for instructions and forms.

## Special Order, Modified, Non-Catalog, or Non-Stock Items

Due to the added resources and difficulty in reselling special or non-standard products, returns or credit are not allowed for special order equipment, special software programs, equipment physically modified or altered in the field, discrete electronic components, relays, manuals, or opened software packages.

## Test Weights

All weights returned for credit will be assessed a restocking charge because of the required inspection and verification. Credit is not allowed for serialized weights, calibration or traceable services performed on weights.

## Balances

Balances returned for credit within 30 days of purchase may be subject to a restocking fee if assessed by balance manufacturer.

# Warranty and Limitation of Liability

## Carrier Product Damage

As part of our commitment to customer satisfaction and in accordance with ISO 9001 standards, we make every attempt to pack our products so they will arrive in new condition. Occasionally due to rough handling or carelessness, product may arrive in a damaged condition. When this happens, don't assume that the shipment left Rice Lake in that condition or that the original packing was not sufficient.

The receiver, whether it is the authorized reseller or their Customer, is responsible for making a notation of damaged or missing items when signing the carrier's delivery receipt. If you or your Customer are not sure whether there is damage, we suggest adding a statement "CONDITION UNKNOWN" to the delivery receipt. In the event that damage or missing items are not properly documented at time of receipt, the carrier is relieved of responsibility and the receiver is then responsible for the cost to get the product back to new condition.

After the damage or shortage has been properly noted with the carrier, contact Rice Lake immediately and keep all the original packaging material for inspection by the carrier's representative. It is also helpful in the claim process to take pictures of the condition of the packaging and damage.

When drop-shipping items to your Customers, it is imperative that you advise them of their responsibility in accepting shipments from common carriers. Even if the equipment is not expected to be installed or used for a period of time, the shipment must be inspected at time of receipt in order to preserve their rights for making a claim.

## How to Prepare a Balance for Shipment

The best and most effective method for shipping a balance at any time and for any reason is to use the original manufacturer's packaging materials and subsequently double box it as described below. Teach your Customers to retain the packing set. Please remember that due to the nature of the equipment, new packaging materials can be very expensive.

In the event that the original manufacturer's packaging materials are not available, follow these instructions for top loading balances.

1. Remove the weighing platform cover, support buttons, weighing platform, floor plate and other devices installed in the weighing chamber. Pack these pieces individually in bubble wrap and tape the wrapping closed. Follow this same procedure for AC adapters and power cords. Please note that AC adapters and power cords are necessary to adequately evaluate the problem.
2. Examine the device (refer to the operating instructions) and if necessary, re-install or tighten any shipping screws/retaining devices to prevent damage to the weighing mechanism during shipment.
3. If the floor plate is not removable, ensure it is securely in place and cannot come loose during shipment, even if the balance is inverted. Do NOT invert the balance to test the security of the floor plate.
4. Clean the device of any loose debris or potential contaminants to our testing facility.
5. Prepare and sign a Statement of Decontamination (form #0679). This form MUST be included in a separate packing list envelope on the outside of the box with the "Statement of Decontamination Form" statement clearly visible.
6. Using Scotch tape or "speed" tape, tape all the glass doors on the device CLOSED. Be sure the tape is securely affixed and will not come off during shipment. Please note that on some devices, the glass breeze break around the weighing chamber can actually be disassembled and packed separate prior to shipment. Refer to the manufacturer's operating instructions. If this is a feature of the device being return, disassemble the breeze break and pack it in its own packing material and box.
7. Use a large box that will provide a minimum of 3 inches of space around the device for loose-fill packing material.
8. Place a padding of foam or Styrofoam (at least 1" thick) at the bottom of the box.
9. Place the balance in a large plastic bag and seal the bag closed.
10. Please put the device on top of the foam padding or Styrofoam from step 8 above.
11. Ensure that there is at least three inches of clearance between the top of the balance and the top of the box.
12. Using generous amounts of anti-static loose-fill packing material, fill all the spaces around the balance. Shake the box to cause the material to settle and add additional loose fill as necessary.
13. Place the small box containing all the items from step 1 above on top of the loose fill covering the balance. Add additional loose fill to completely cover all items within the box.
14. Double pack this box in another box that will again provide an additional two inches of space around the inner box. Fill all existing space between the inner and outer box with copious amounts of anti-static loose fill packing material.
15. Seal the box and include all the necessary documentation on the outside of the box. Don't forget the Decontamination Form (form #0679) from step 5 above.

## Repair Service Policies

Our Service Department is staffed Monday through Friday from 6:30 A.M. to 6:30 P.M., and Saturday from 8:00 A.M. to noon, Central time. For those utilizing the conveniences of the internet, we have an e-mail address dedicated to technical support. Please contact RLWS at [service@ricelake.com](mailto:service@ricelake.com) for answers to your technical questions and the status of repair products during normal business hours.

## Standard Repair Service Policy and Rates

We provide quality and timely repairs for the products we sell. Flat rate repair is offered for selected models of indicators, printers, and remote displays. Prior to returning a product for repair, our Returns Department will work with you to determine some key factors that will help RLWS better serve you. Please provide the following via phone to extensions 5348 or an RMA form.

# Warranty and Limitation of Liability

- Customer number: Without a customer number we cannot issue an RMA number.
- Ship-to address: Your customer number will bring up the bill-to address. You must inform RLWS of the ship-to address if it's different than the bill-to address.
- **Original sales and invoice orders: Required on warranty claims.**
- Freight type: Unless stated otherwise, we ship the device back to you utilizing the same freight type in which we received it. If Rice Lake is responsible for freight charges, the carrier will be selected at the sole discretion of Rice Lake.
- **Definition of product and problem: Please provide as much detail as possible regarding the type of product, application and problem.**
- Purchase order number for flat rate repair: Once we receive the equipment and the RMA, equipment for flat rate repair will be processed immediately. Other equipment will be evaluated and a minimum \$45 evaluation charge will apply.

You may be asked about the possibility of a new replacement product. It may be in your Customer's best interest to explore the option of purchasing a new product if the repair will exceed 50% of authorized reseller net price, since new products carry full warranty benefits.

Please note that our hourly service rate on all current Rice Lake products is \$125.00/hour. There is a 120-day limited warranty on parts and workmanship performed and noted under the scope of the specific repair.

## Balance Repair Policy and Rates

We offer repair support on the following balance models:

- All Rice Lake brand models

Once we receive the equipment and the RMA form, an estimate will be prepared.

A minimum charge of one hour will apply.

Please note that the hourly service rate on all balances is \$125.00/hour. All balance repairs are covered by a 90-day limited warranty on parts and workmanship performed and noted under the scope of the specific repair. Balances must be packaged to adequately protect them from damage in transit. Please refer to "How to Prepare a Balance for Shipment" available on our website and from our Returns Department.

## Test Weights

No returns will be accepted for items that are specifically modified for the Customer's requirements. Examples of such modifications may include, but not necessarily limited to:

1. Weights that have been specifically built to the Customer's specifications.
2. Standard product specifically modified to the Customer's specifications.
3. Standard product engraved with serial numbers at the customer's request.
4. Laboratory procedure charges.
5. Laboratory documentation fees.

## Load Cell Evaluation Policy, Repairs and Rates

We support, service, repair and perform warranty evaluations on all Rice Lake brand load cells. We also provide repair evaluation for other manufacturers' load cells through each manufacturer's established service policies.

## Power Conditioning Policy

Rice Lake Weighing Systems recommends the installation of AC and/or DC transient protection which has proven to be effective in significantly reducing both the frequency and degree of damage caused by AC and/or DC transient voltage occurrences. Rice Lake Weighing Systems does not warrant or guarantee any transient protection device against damage or repair sold by it or any of its representatives or authorized resellers. Rice Lake Weighing Systems does not warrant or guarantee any scale-related or other electrical/electronic device against damage or repair which is intended to be protected by any transient protection device sold by it or any of its representatives or authorized resellers. Any damage or repair expense resulting from a transient strike or occurrence including the transient device itself, as well as the components intended to be protected, will not be at the expense of Rice Lake Weighing Systems. No other warranty or guarantees—express or implied—contrary to this written policy are supported or acknowledged by Rice Lake Weighing Systems.

## Field Service Rate Policy

For field service, we provide the services of highly-trained professionals for the following rate: \$1080.00 list per work day (not to exceed eight work hours). Additional daily hours are prorated at \$200.00/hour.

An additional 50% charge is added for services performed on Saturday and Sunday. The authorized reseller is responsible for travel expenses between Rice Lake, Wisconsin and the job location, regardless of the mode of transportation. Meals, lodging, and shipment of special equipment to and from the on-site location are billed to you at cost.

# Warranty and Limitation of Liability

## Exchange Board Policy

### Exchange Procedures

Simply call Rice Lake Weighing Systems' Service Department and specify the exchange circuit board you require. We issue a return authorization number for your return and immediately ship you a reconditioned circuit board.

Upon receipt of your returned product, an inspection is made to ensure that it can be rebuilt or repaired. If it meets the inspection/analysis criteria for our exchange program, a credit is immediately applied to your account. Credit is not issued on any returned product that, upon inspection and analysis by our Service Department, is determined to be unrepairable or obsolete. Circuit boards that have been physically altered or modified are not eligible for exchange. If your return does not qualify under these guidelines, you are contacted and disposition of your return is mutually agreed upon.

Discontinued products' exchange boards may have limited availability.

### Circuit Board Inspection/Analysis

All incoming boards are subject to an inspection to determine if they are eligible for our exchange program. A returned board is considered eligible for the exchange board program provided it:

- has all its traces intact.
- does not contain corrosion, burn marks or lightning damage.

- has not been field-repaired using incorrect soldering or service techniques.
- has not been painted or coated with a foreign substance.
- sense traces are cut, no core credit.

Upon passing inspection, a credit for your returned board is immediately applied to your account.

### Warranty

We offer a 120-day limited warranty on exchange circuit boards. The replacement board exchange list price is 80% of the new board list price. All level 1, 2, 3 and 4 authorized resellers receive a 25% discount off of the board exchange list price.

**Note: An \$85.00 exchange board credit is given when a usable board is returned.**

### REPAIR BOARD EXCHANGE EXAMPLE:

<b>IQ plus® 355</b>	
Exchange Board List .....	\$332.00
LESS 25% Authorized Reseller Discount .....	\$249.00
Exchange Board Credit.....	\$85.00
Final Net Price .....	\$164.00

### COMPARE AND SAVE:

<b>IQ plus® 355</b>	
New Board List.....	\$425.00
LESS Max Discount.....	\$269.75
You Save .....	\$105.75

## EXCHANGE CIRCUIT BOARDS

Part #	Model	Board Type	Exchange List Price	Authorized Reseller Net	FINAL NET Price*
<b>Indicators</b>					
99345	120 reconditioned, external connector .....	CPU .....	\$188.00.....	\$141.00.....	\$100.00**
99346	120 reconditioned, internal connector .....	CPU .....	188.00.....	141.00.....	100.00**
64736	UMC222 reconditioned.....	DISP/CPU.....	396.00.....	297.00.....	212.00
31436	IQ plus® 310A reconditioned .....	DISP/CPU.....	516.00.....	387.00.....	302.00
31438	IQ 310A reconditioned .....	P/S.....	300.00.....	225.00.....	140.00
68442	IQ plus® 355 reconditioned .....	DISP/CPU.....	332.00.....	249.00.....	164.00
68439	IQ plus® 390 reconditioned .....	DISP/CPU.....	356.00.....	267.00.....	182.00
23033	UMC555 reconditioned, RFI.....	CPU .....	396.00.....	312.00.....	227.00
85930	420 reconditioned .....	CPU .....	376.00.....	282.00.....	197.00
94559	420 HE reconditioned .....	CPU .....	400.00.....	300.00.....	215.00
88811	IQ plus® 510 reconditioned .....	CPU .....	500.00.....	375.00.....	289.00
83132	520 reconditioned .....	CPU .....	456.00.....	342.00.....	257.00
88810	IQ plus® 590 reconditioned .....	CPU .....	356.00.....	267.00.....	182.00
19278	UMC 600/IQ 700 reconditioned, RFI.....	CPU .....	520.00.....	390.00.....	305.00
68440	IQ plus® 710 reconditioned, ver. 2.0.....	DISP/CPU.....	500.00.....	375.00.....	290.00
105923	720i™ reconditioned .....	CPU .....	600.00.....	450.00.....	365.00
40645	IQ plus® 800/810 recond., single channel, SMT.....	CPU .....	500.00.....	375.00.....	290.00
22775	IQ plus® 810 reconditioned .....	P/S.....	488.00.....	366.00.....	281.00
101399	820i dual chn. reconditioned.....	CPU .....	796.00.....	597.00.....	512.00
97267	820i® signal chn. reconditioned.....	CPU .....	680.00.....	510.00.....	425.00
83133	920i® reconditioned.....	CPU .....	660.00.....	495.00.....	410.00
100345	320IS CPU board reconditioned .....	CPU .....	396.00.....	297.00.....	212.00
114529	DWM IV motherboard reconditioned.....	CPU .....	450.00.....	175.00.....	N/A**
114530	DWM IV A/D board reconditioned.....	A/D.....	270.00.....	135.00.....	N/A**
114531	DWM IV display board reconditioned .....	DISP.....	190.00.....	135.00.....	N/A**
<b>Remote Displays</b>					
71629	F Series reconditioned.....	CPU .....	336.00.....	252.00.....	167.00
85932	LaserLight® reconditioned .....	CPU .....	292.00.....	219.00.....	134.00
<b>Bench Scales</b>					
36782	CW-80 reconditioned.....	CPU .....	408.00.....	306.00.....	221.00
71628	IQ plus® 2100 reconditioned .....	CPU .....	284.00.....	213.00.....	128.00

\* After the \$85.00 exchange board credit has been issued to your account. Board exchange list prices are subject to change without notice based on 80% ratio to new board pricing.

\*\*The 80% exchange list price or the \$85.00 exchange credit may not apply to these boards

# Automated Ticketing

## Table of Contents

<b>Weigh Out/Printer Kiosk</b> .....	<b>26</b>
Automated Truck Scale System	
<b>Weigh/Check In Kiosk</b> .....	<b>28</b>
Automated Truck Scale System	
<b>Printer Kiosk</b> .....	<b>29</b>
Automated Ticketing Printer Kiosk	
<b>OnTrak™</b> .....	<b>32</b>
Truck Data Management Software	
<b>TransAct® LE/TransAct/TransAct Plus</b> .....	<b>34</b>
Truck Data Management Software	
<b>Kiosk Safety Swing-Away Arm</b> .....	<b>36</b>
Self Centering Kiosk Mount	
<b>Vehicle Loop Detector</b> .....	<b>37</b>
<b>EMX Lite Preformed Loops®</b> .....	<b>37</b>
<b>RFID</b> .....	<b>38</b>
Transcore® SmartPass®	
<b>RFID Access Tags</b> .....	<b>39</b>
<b>RFID Transportation Tags</b> .....	<b>40</b>
<b>HID RFID Cards, Keys and Tags</b> .....	<b>40</b>
<b>HID RFID Readers</b> .....	<b>41</b>
<b>Model G-89 Barrier Gate</b> .....	<b>42</b>
<b>Photo Eyes</b> .....	<b>42</b>
<b>Traffic Light Kits</b> .....	<b>43</b>
<b>Intercom AI PHONE</b> .....	<b>44</b>

**ESPAÑOL** | Visit [ricelake.com/spanish](http://ricelake.com/spanish)  
to see all RLWS materials  
available in Spanish

Product names, logos, brands, and other trademarks featured or referred to within this publication are the property of their respective trademark holders.

# Weigh Out/Printer Kiosk

Automated Truck Scale System

## Standard Features

- 920i® HMI with sun shield
- Six serial ports
- 1 MB database memory
- Two additional expansion slots
- Slide door access to ticket
- 8 in paper roll (PN 105446)
- Operator prompting
- Formatable tickets that print at the end of a transaction
- Traffic light control
- Transmits weight to remote display (only when activated)
- Internal printer is standard in PN 119687

## Optional Features

- Single or dual channel A/D cards
- RFID reader
- Credit card reader
- Qwerty keyboard
- Internal heater
- Currency acceptor (U.S. currency only)
- Gate control
- Loop detector input
- Internal printer

### Consult for the following options

- Stainless steel enclosure
- RF tags/antenna for truck IDs
- Barcode badge scanner
- 230V AC
- Foreign currency acceptor
- Numeric keypad
- H/D card reader with numeric keypad



*Shown with optional features*

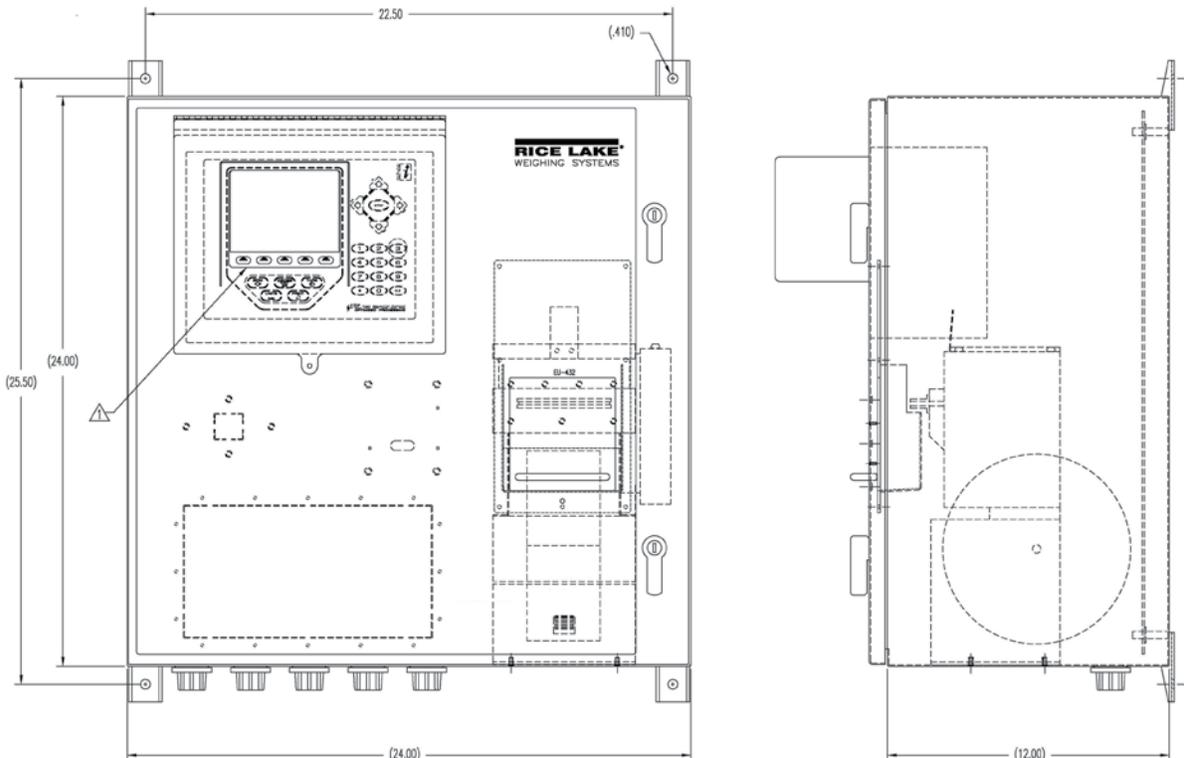



# Weigh Out/Printer Kiosk

Automated Truck Scale System

## Part Numbers/Price

PART #	DESCRIPTION	EST. SHIP WEIGHT	PRICE
119687	Weigh out kiosk with 920i <sup>®</sup> HMI and Epson <sup>®</sup> EU-T482 printer, 24 x 24 x 12 in painted mild steel enclosure, A/D not included		\$5,205.00

## Options/Accessories

PART #	DESCRIPTION	PRICE
75850	SURVIVOR <sup>®</sup> LaserLight <sup>®</sup> Series remote display, 4 in	\$1,500.00
75852	SURVIVOR <sup>®</sup> LaserLight <sup>®</sup> Series remote display, 6 in	1,950.00
21159	Internal transient protection	245.00
23146	Traffic light	710.00
119691	Vandal-proof 12-key keypad	405.00
119743	HID RFID card reader	505.00
119692	88 key, panel mount Qwerty style keyboard	715.00
119693	200 watt heater	505.00
119761	Ethernet unmanaged switch, five port	279.00
119689	Kiosk option, A/D single channel, includes DIN rail and terminals	315.00
119690	Kiosk option, A/D dual channel, includes DIN rail and terminals	465.00
119946	Single port Ethernet server	405.00
120040	Dual port Ethernet server	565.00
33490	Relay rack 4 channel Opto 22 style with screws	65.00
	22 mm Allen-Bradley push buttons with legend plates	150.00

## Replacement Parts

PART #	DESCRIPTION	PRICE
155751	EU-T482 (requires 23112 power supply)	\$1,170.00
23112	Power supply PS-180	110.00
105445	Paper 6 in OD, one ply thermal 80 mm (3.1 in) 710 ft/roll	25.00
105446	Paper 8 in OD, one ply thermal 80 mm (3.1 in) 1268 ft/roll	27.00
54215	3.15 amp 250V Slo Blo 5 x 20 mm kiosk power input fuse	3.00

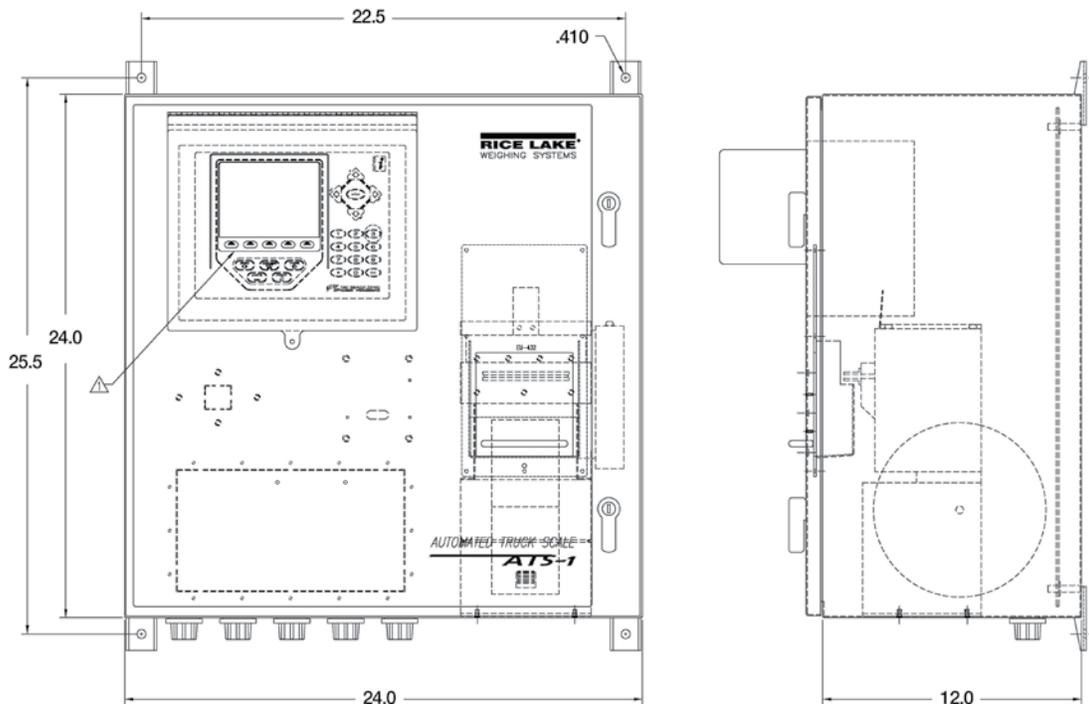

# Weigh/Check In Kiosk

Automated Truck Scale System

## Standard Features

- 920i<sup>®</sup> HMI with sun shield
- Four serial ports
- 120VAC
- Two option slots for 920 option cards

## Part Numbers/Price

PART #	DESCRIPTION	EST. SHIP WEIGHT	PRICE
153353	Check-in kiosk with 920i HMI, 20 x 20 x 12 in painted mild steel enclosure		\$2,955.00

## Options/Accessories

PART #	DESCRIPTION	PRICE
119691	Vandal-Proof 12-key keypad	\$405.00
119743	HID RFID card reader	505.00
119692	88 key, panel mount Qwerty style keyboard	715.00
119693	200 watt heater	505.00
119761	Ethernet unmanaged switch, five-port	279.00
119689	Kiosk option, A/D single channel, includes DIN rail and terminals	315.00
119690	Kiosk option, A/D dual channel, includes DIN rail and terminals	465.00
119946	Single port Ethernet server	405.00
120040	Dual port Ethernet server	565.00



Shown with optional 12-keypad and HID RFID card reader

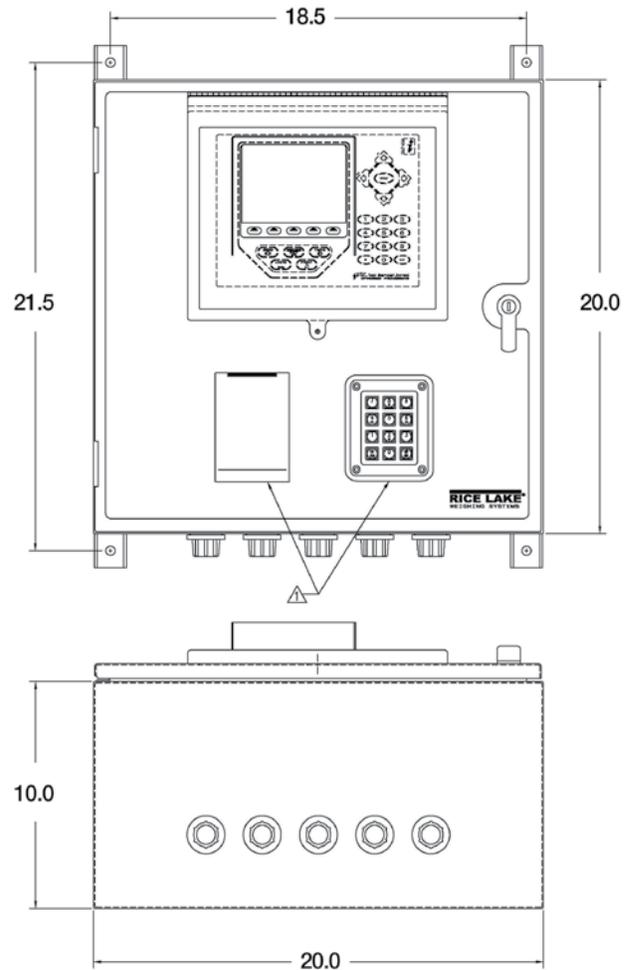

Illustration for dimensions only

# Printer Kiosk

## Automated Ticketing Printer Kiosk

### Standard Features

- Epson® EU-T482 direct thermal tape printer
- Slide door access to ticket
- 8 in paper roll (PN 105446)

#### Printer Kiosk with Intercom

- Intercom substation AI Phone

#### Printer Kiosk with Ethernet Intercom

- Intercom substation AI Phone Ethernet TCP/IP

### Specifications

#### Line Voltages:

115 or 230 VAC

#### Frequency:

50 or 60 Hz

#### Power Consumption:

0.5 amps (depending on options)

#### Fusing:

0.8 amps circuit breaker

#### Digital I/O:

4 TTL level  
Optional relay

#### Humidity:

0-95% relative humidity

#### Rating/Material:

NEMA 3  
IP63

#### Serial Ports:

Two RS-232  
Ethernet

#### Display:

Optional 2 line x 20 character vacuum fluorescent display

#### Keyboard:

Optional 12-key stainless steel weatherproof keyboard

#### Storage Temperature:

14° F to 158° F (-10° C to 70° C)

#### Current Supported Riser Plates:

Zebra® 140XIIIPlus  
Zebra 105SL  
Zebra R110Xi  
Zebra Z4Mplus  
Zebra 2746e  
Datamax-O'Neil® I-4208  
Datamax-O'Neil 4206  
Datamax-O'Neil I-4308  
Datamax-O'Neil I-4210  
Datamax-O'Neil I-4212  
Intermec 3400e  
Intermec 4440

#### Warranty:

Two-year limited warranty

#### Approvals:

UL and C-UL listed



Basic Printer Kiosk with optional RFID card reader and optional number keypad



Basic Printer Kiosk



Basic Printer Kiosk with optional RFID card reader

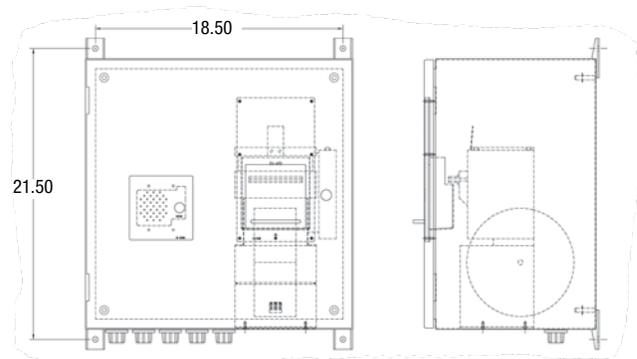

Printer Kiosk with Intercom

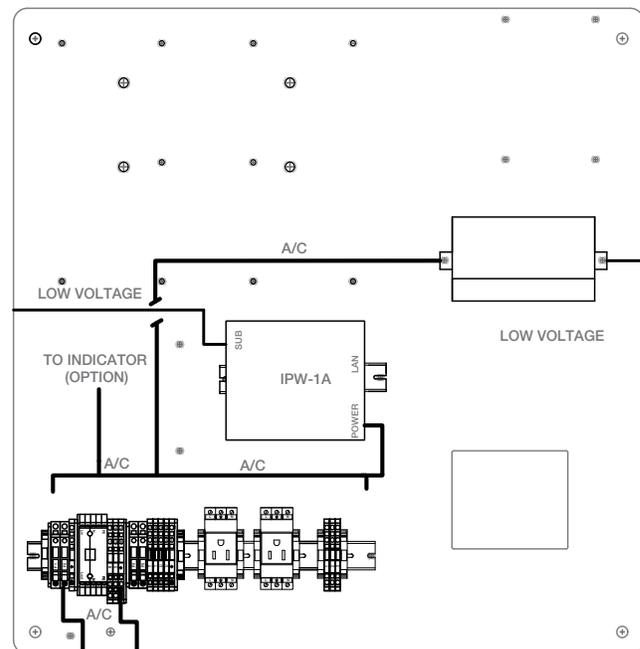

Printer Kiosk with Ethernet Intercom

# Printer Kiosk

Automated Ticketing Printer Kiosk

## Functions of the Kiosk Suite

*Multi Kiosk Configuration Illustrated*

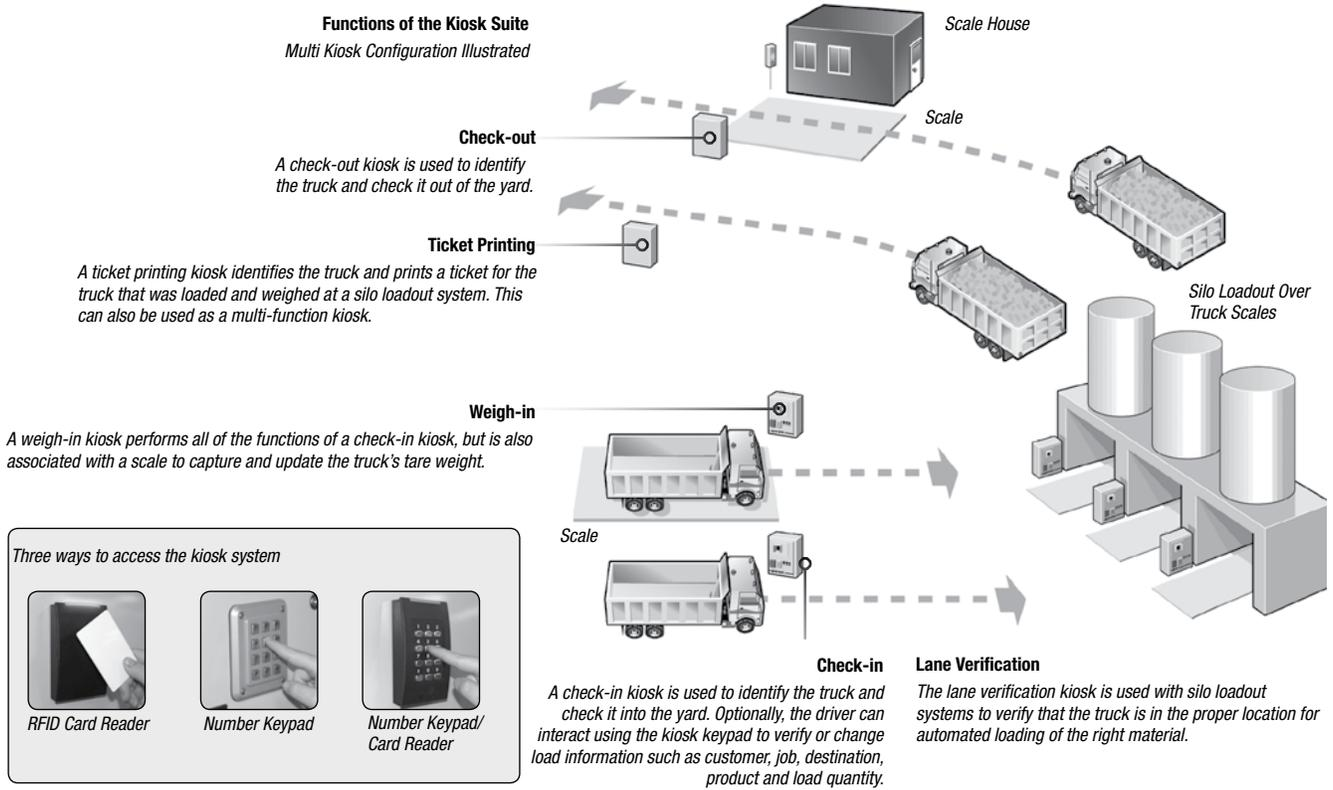

### Three ways to access the kiosk system



RFID Card Reader



Number Keypad



Number Keypad/  
Card Reader

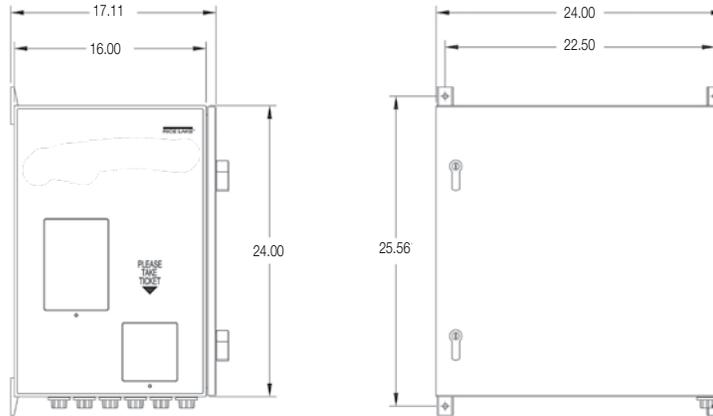

# Printer Kiosk

## Automated Ticketing Printer Kiosk

### Part Numbers/Price

PART#	DESCRIPTION	PRICE
92971	Printer kiosk, inbound base unit 115V AC (printer not included)	\$2,545.00
120028	Printer kiosk, Epson® EU-T482 with AI Phone intercom/requires base station use either 107601 or 107603. 20 x 20 x 12 painted mild steel enclosure	4,185.00
120029	Printer kiosk, Epson EU-T482 with AI Phone Ethernet intercom/requires use of PC. 20 x 20 x 12 in painted mild steel enclosure	5,305.00
112836	Printer kiosk, Epson EU-T482 in 20 x 20 x 12 in painted mild steel enclosure	3,365.00
93478	Printer kiosk installation manual (included with each kiosk)	55.00

A test plan is included with each kiosk.

Consult factory for private label versions.

### Options/Accessories

PART #	DESCRIPTION	PRICE
119693	200 watt heater	\$505.00
119761	Ethernet unmanaged switch, five-port	279.00
119946	Single port Ethernet server	405.00
120040	Dual port Ethernet server, for use with 120028 and 120029	565.00
107601	Base station, one channel, for use with 120028	1,095.00
107603	Base station, five channel, for use with 120028	1,635.00
105445	Paper roll 6 in OD, one ply thermal 80 mm (3.1 in) 710 ft per roll	25.00
105446	Paper roll 8 in OD, one ply thermal 80 mm (3.1 in) 1268 ft per roll	27.00
93463	Printer riser plate for Datamax® I-4212e	255.00
93468	Printer riser plate for Intermec 3400e	255.00
157188	Transportation tag 1/2 frame with battery, Transcore AT5414	75.00
86399	Transportation tag 1/2 frame, Transcore AT5414	60.00
157184	Transportation window tag (must order in quantity of 50), Transcore AT5402	40.00
119743	HID iClass RW400 reader antenna	505.00
89190	TT Tag stock 4 in wide, 7.5 pt continuous 400 ft roll	38.50
34056	Transfer ribbon, 4 in wide GPR Plus black 1181 ft roll	25.25
131143	Datamax® I-4212e, direct thermal RS-232, parallel and USB	1,595.00
64884	Thermal transfer option	100.00
131150	Ethernet option	325.00
53918	Cutter option	695.00
109298	Tag, direct thermal, 4 in wide, 7.2 pt continuous 480 ft roll	40.00
158974	Single channel audio amplifier for Ethernet intercom (use with speaker horn 107604)	152.00

### Standard Features

- Supports Windows XP SP3 (32-bit), Vista SP 2 (x86 or x64), and Windows 7 (x86 or x64) Systems
- SQL Server 2005 Express Client/Server Database
- Comprehensive report filters
- User & administrator filters
- Backup and restore via included SQL Server Management Studio Express
- Unlimited charge/discount per product
- Ship or receive mode for each transaction
- Exclusive database for: customer, hauler, truck, product, job, price/dDiscount, tax, transaction
- Ethernet TCP/IP or RS-232 connectivity
- Supports VIRTUi/VIRTUi2® or Rice Lake weight indicators

### Optional Features

- Interface to non-Rice Lake weight indicators
- Custom reports
- Database configuration
- Field installation & training
- Factory phone support

### Specifications

#### System Requirements:

- Windows® XP (SP3)/VISTA (SP2)/Windows 7
- 1.5 GHz processor or higher
- 512 (minimum) of RAM
- 100 mb hard drive (minimum)

#### Databases:

- 4 GB max database size when using included MS SQL Server 2005 Express, unlimited with standard version of MS SQL Server.
- Backup and restore via included SQL Server Management Studio Express

#### Communications:

- Support for multiple printers
- Supports all Rice Lake indicator interfaces
- Supports VIRTUi/VIRTUi2 interface
- Optional drivers available for non-Rice Lake weight indicators

#### Transaction Ticket:

- User defined ticket formatting

#### Reports:

- Comprehensive report filters
- Optional custom reports

#### Export Data:

- File transfer via XML transaction. Export reports can saved as PDF/XLS

#### Transaction Calculations:

- Unlimited product prices & discounts
- Tax calculations

#### Software Support:

- Database configuration, field installation, and training available
- Phone support packages available, contact Rice Lake for further options

#### Approvals:

- NTEP CC 05-107



Weigh Scale

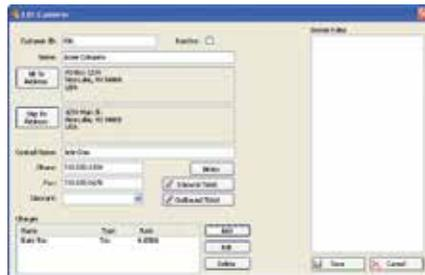

Customer Account Information

### APPROVALS



**Database Features**

<b>Transaction:</b> Truck ID Customer ID Job Product Weigh In T and D Weigh Out T and D Gross Weight Tare Weight Net Weight Tare Type Units Void Ship Mode	<b>Job Price:</b> Job # Product # Amount Ordered Amount Delivered Discount	<b>Charge:</b> Charge Name Charge Rate Charge Type
<b>Transaction Charge:</b> Transaction # Charge Name Charge Rate Charge Type	<b>Truck:</b> Truck ID Tare Are Acquired Tare Expiration Tare Type Name Minimum Weight Maximum Weight Radio Tag ID Customer ID Job # Product # Hauler #	<b>Discount Schedule:</b> Name Rate
<b>Product:</b> Product Name Product ID Price Description Minimum Charge	<b>Hauler:</b> Name Address Phone Fax Contact Name	<b>Address:</b> Line 1 Line 2 Line 3 City State Postal Code Country
<b>Product Charge:</b> Product Charge Job Job ID Job Name Job Closed Customer #	<b>Weigh In:</b> Truck ID Customer ID Job # Product # Weigh In T&D Weight Value	<b>Customer:</b> Customer ID Name Bill to Address Ship to Address Phone Fax Contact Name
		<b>Hauler:</b> Name Address Phone Fax Contact Name Inactive Discount Level
		<b>Customer Charge:</b> Customer ID Charge #

**Part Numbers/Price**

PART #	DESCRIPTION	PRICE
104787	OnTrak activation code	\$1,395.00
101062	OnTrak CD-ROM*	80.00

*OnTrak trial at [www.ricelake.com/ontrak](http://www.ricelake.com/ontrak)*

**Options/Accessories**

PART #	DESCRIPTION	PRICE
Consult	Non-Rice Lake indicator interface	\$195.00
Consult	Custom reports	95.00/hour
Consult	Database configuration	95.00/hour
Consult	Field installation	1,080.00/day plus expenses
104789	Phone support, onehour	95.00
104790	Phone support, 10 hours	895.00
104791	Phone support, 25 hours	2,000.00
104792	Phone support, 50 hours	3,500.00
101003	Additional OnTrak manual	55.00
151626	Camera, Ethernet TCP/IP (additional software and power injector required)	1,465.00
131605	Power supply, injector (enclosure sold separately)	155.00
23143	Power cord for 131605	11.00

# TransAct® LE/TransAct/TransAct Plus

Truck Data Management Software

## Standard Features

### TransAct LE/TransAct/TransAct Plus

- Intuitive menu-driven programs
- Ticket editing, voiding, reprinting with the Quickscan utility
- Report to screen, printer or export
- Password protection
- Easy-to-use graphic interface
- Full mouse and keyboard support
- Interfaces to ticket, tape, dot-matrix and laser printers (TransAct LE only)
- Unlimited configurable ticket formats (TransAct LE only)
- Fault-tolerant data recovery to protect from system crashes
- Barcode, magstripe and RFID interface
- Full database backup and purge functions
- Truck "Overweight" warning
- Predetermined keyboard and automatic tare entry
- Transaction importing/exporting for long distance transfers in non-networking applications

### TransAct/TransAct Plus

- Three configurable tares
- Four configurable categories
- Configurable product rates
- Multiple scale operation
- Multiple transactions per ticket
- Networkable
- Job table for contract purchases
- Full reporting by account, revenue, tonnage, material and transaction (TransAct Plus only)
- Accounts payable and receivable (TransAct Plus only)
- Prints customer invoices and statements with detailed transaction information (TransAct Plus only)
- Expandable reporting features (TransAct Plus only)
- Credit weight limits (TransAct Plus only)
- Aging report showing current and extended balance 30, 60 and 90 days (TransAct Plus only)

### TransAct 5.5.11 Features

- 32-Bit application
- Faster, more reliable Access 2003 database
- Fewer compatibility issues running under Windows XP and future operating systems
- Preemptive multitasking enables greater application performance
- More organized and flexible Weigh Form Stand-Alone Reporting Tool (using Crystal 9.0)
- More report types and more flexible reports
- Reports can be saved in PDF and plain text formats
- Reports can be saved as Excel spreadsheets
- Reports can be saved as comma or tab delimited separated ASCII formats
- Group Tree - quickly navigate to a specific major sort order section
- Printer setup button can be used to select a printer other than the default windows printer
- Check box to allow for page breaks between major groupings
- Freight
- Individual or global hauler account freight table
- Available freight charge field for each job item - overrides the hauler account freight table
- Implementation of zones and hauler payables
- Expanded tax structure
- Generate an unlimited list of tax authorities (examples: Federal (5%), State (.5%), City (.2%), County (.1%))

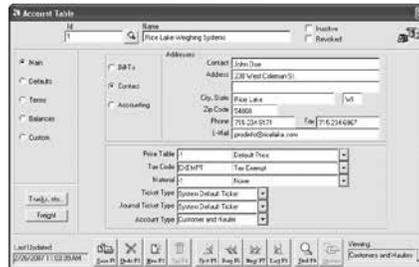

Customer Account Table

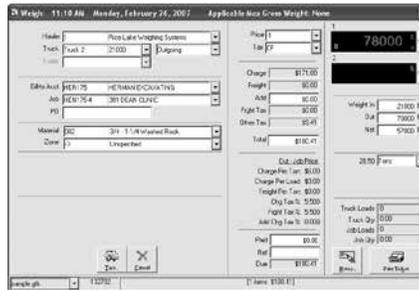

Truck/Container Cash Transaction

## APPROVALS



## Standard Features

- Generate unlimited tax codes from the list of tax authorities up to five tax authorities can be selected for each tax code (examples: Federal + State = 5.5%, Federal + State = 5.7%)
- Detailed tax reports by each tax authority
- Updated accounting features (TransAct Plus only)
- Invoice processing is separate from statement processing
- Two invoice options available (open item, balance forward)
- Retained the Rev. 3 combined invoices/statement option (balance forward list ticket)
- Invoice and statement printing options (print summary report, print detailed report)
- Invoice and statement reprinting options (by range of invoice numbers or date) (reprint invoice, reprint summary report, reprint detailed report)



# TransAct® LE/TransAct®/TransAct® Plus

Truck Data Management Software

## Specifications

### System Requirements:

- Windows® XP 32-bit with service pack 2 or later
- Windows 7 service pack 1 or later
- Windows 8

### Hardware:

- Intel® AMD® Processor, 1 GHz or greater
- 1 GB of Ram or greater
- 1 GB available storage space (data dependent)

### Databases:

- Virtually unlimited with user-definable categories
- Automatic journaling with automatic rebuild after crash or power interrupt

### Communications:

- Support for two printers with selectable drivers for most popular printers

### Transaction Ticket:

- Configurable weigh-in and weigh-out ticket formats, complete selection of variables and data types

### Reports:

- Full reporting capabilities by account, vehicle, material, hauler, area, ticket, truck, container, trailer or date
- Age reports 30, 60 and 90 days

### Export Data:

- Reports can be exported via tab-delimited file format
- Export/Import function for transferring transaction data in non-networking applications

### Transaction Calculations:

- Definable product rates, charges, taxes and customer discounts. Configurable percentage weight reductions for moisture and dockage

### Accounting:

- Full accounting capabilities
- Accounts payable
- Accounts receivable
- Balance/reconciliation

### Software Support:

- Rice Lake Weighing Systems offers field software support for TransAct LE/TransAct/TransAct Plus. Contact our service department for software support. Software support is a chargeable service

### Approvals:

- NTEP CC 97-034

## Part Numbers/Price

PART #	DESCRIPTION	PRICE
79079	TransAct LE version 5.5.11	\$1,385.00
43898	TransAct version 5.5.11	2,345.00
98089	Additional seat TransAct 5.5.11 (must be purchased with original 5.5.11)	965.00
43899	TransAct Plus version 5.5.11	4,645.00
98090	Additional seat TransAct Plus 5.5.11 (must be purchased with original 5.5.11)	1,785.00

\*TransAct demos can be downloaded from our Web site at [www.ricelake.com](http://www.ricelake.com)

## Options/Accessories

PART #	DESCRIPTION	PRICE
15547	Blunt end, 25-pin D-sub male RS-232 serial interface cable	\$65.00
<b>Interfaces to: UMC444, UMC555, UMC600, IQ 700, IQ plus® 310A, 355, 390-DC, 510, 590-DC, 710, 800, 810, 520 and 920i</b>		
42745	pcANYWHERE® for Windows®, host and remote version	295.00
50270	Additional operating manual	25.00
98091	Upgrade from TransAct LE to TransAct 5.5.11	Consult
98092	Upgrade from TransAct LE to TransAct Plus 5.5.11	Consult
98093	Upgrade from TransAct to TransAct Plus 5.5.11	Consult
Consult	Quickbooks® interface for TransAct 5.5.11	Consult
Consult	Quickbooks® interface for TransAct Plus 5.5.11	Consult
Consult	Sage Interface (formerly Peachtree) for TransAct 5.5.11	Consult
Consult	Sage Interface (formerly Peachtree) for TransAct Plus 5.5.11	Consult
98103	Two hours configuration installation and training service	385.00
98104	Four hours configuration installation and training service	765.00
98105	Eight hours configuration installation and training service	1,525.00

# Kiosk Safety Swing-Away Arm

## Self Centering Kiosk Mount

Finally, a solution to mounting kiosk enclosures next to truck scales. The universal Swing-Away Kiosk mounting assembly from Rice Lake takes the worry out of correctly positioning kiosks in vehicle scale applications. The swing-away arm provides protection from trucks that pull up too close to the kiosk, then returns to center after impact automatically.

### Standard Features

- Protects all kiosks from truck mirrors, fenders and cabs
- Swings away freely and returns to center position
- Universal mount accommodates a wide variety of kiosks
- Includes mounting pole and base stand



### Part Number/Price

PART #	DESCRIPTION	PRICE
105939	Weldment, swing arm, kiosk	\$555.00
105940	Pole weldment, 12 ft supported/free standing 4.5 in o.d.	505.00
105941	Pole weldment, 10 ft supported/free standing, 4.5 in o.d.	455.00
109163	Complete kit for above ground scale (12 ft pole)	1,015.00
109164	Complete kit for pit type scale (10 ft pole)	915.00
110606	Weldment, swing arm 24 x 24 x 16 side discharge printer kiosk	555.00
155435	Weldment, swing arm 30 x 24 x 16 side discharge printer kiosk	745.00

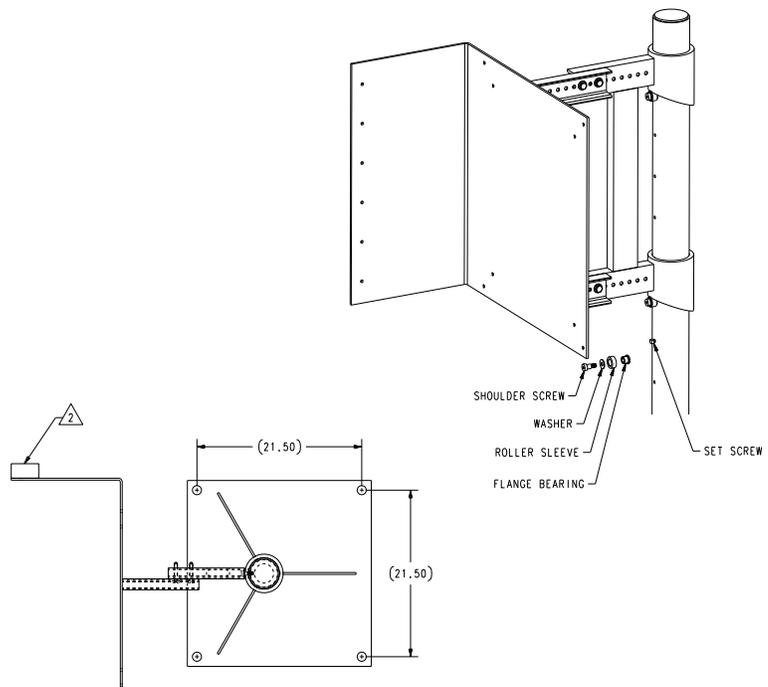
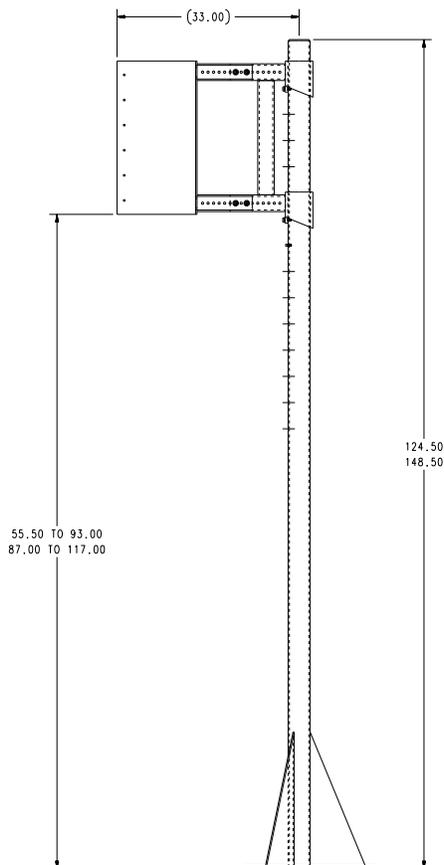

# Vehicle Loop Detector

## Standard Features

- Vehicle Loop Detector
- Loop diagnostics
- Loop isolation transformer
- Loop conditioner
- Aluminum RF shield housing
- Surge protection
- Loop frequency counter
- 10 gold plated sensitivity controls
- Eight gold plated function controls
- Six gold plated controls for frequency, reset and frequency counter
- Two high intensity LED indicators
- Two relays - relay 2 is pulse or presence



## EMX Lite Preformed Loops®

### Standard Features

- Rugged and flexible TPE tubing
- Electronic lightning protection of vehicle detectors
- Comes standard with 50 feet of twisted and jacketed lead-in wire
- Vehicle detection loop is constructed of stranded wire conductors with thermoplastic elastomer insulation jacketing
- Outer shell is flexible, nonmetallic 0.26 inch tubing
- Two relays - relay 2 is pulse or presence



### Specifications

#### Vehicle Loop Detector Power:

The detector is available in the following voltages: 12V AC/DC, 24V AC, 24V DC, 110V AC, 220V AC. Maximum current draw 100 mA

#### Low Power:

Detector is available with maximum current draw of 60 mA

#### Temperature:

-40° F to 180° F

#### Enclosure:

Extruded anodized aluminum,  
3.25 H x 2.56 W x 3.65 in D (83 H x 40 W x 90 mm D)

#### Output Relays:

5A/125V AC standard version, 1A/125V AC low current version

#### Connector:

86CP11 compatible with 11pin Octal DIN rail mountable socket or wire harness

#### EMX Lite Preformed loops Operating Temperature:

-60° F to 260° F

#### Overall Diameter of Loop Wire:

0.26 in

#### Loop Dimensions:

4 x 6 ft thru 4 x 12 ft standard, custom sizes available

#### Lead-in-wire:

50 ft long, twisted wire in PVC jacket

#### Loop Wire Approvals:

UL subject 13, Type PLTC 300V, 90C passes IEEE-328,210,000, BTU Flame Test Pennsylvania, Bureau of Deep Mine Safety, Approval P-MWMS-1-85

### Part Number/Price

PART #	DESCRIPTION	PRICE
86601	4 x 8 ft-3 ft range	\$615.00
86759	4 x 10 ft-4 ft range	615.00

## RFID

Transcore® SmartPass®

### Standard Features

- Fully self-contained, integrated reader
- Ideal for truck scales and parking and access control applications
- 915MHz RF band operation
- Compatibility with a wide range of industry-standard formats
- Weatherproof enclosure
- Quick, simple installation by trained, authorized personnel
- Programmable RF power
- Half frame and full frame capability

### Specifications

**Frequency Range:**

902 to 928 MHz

**RF Control:**

By sense output or host command

**Polarization:**

Linear, horizontal

**Read Range:**

Read performance varies depending on tag and reader configuration and environment. Read range for all the SmartPass E4 Reader is 12 ft (3.7 m) typical to 17 ft (3.7 m) maximum

**I/O Control:**

Input: Two independent dry contact closures for sense circuits

Output: Two independent Form-C contacts

**Dimensions:**

15.5 x 15.5 x 3.25 in  
(39.4 x 39.4 x 8.25 cm)

**Weight:**

9.5 lb (4.3 kg)

**Mounting Surface:**

Mount to pole or wall, indoor or outdoor

**Enclosure:**

Tamper-proof, polycarbonate housing

**Operating Temperature:**

-40° F to 131° F (-40° C to 55° C)

**Humidity:**

100% condensing

**Vibration:**

0.5 grams, 10 to 500Hz

**Input Power:**

16-20V AC, 47-63Hz, or 16-28V DC



### Part Number/Price

PART #	DESCRIPTION	PRICE
108201	SmartPass E4 reader only	\$6,395.00
162431	18VAC power supply	45.00
86401	5 ft interface cable	155.00
162430	20 ft interface cable	310.00
86403	35 ft interface cable	465.00
162432	Pole/wall mount bracket	135.00

# RFID Access Tags

## Standard Features

- Interior mounting on non-metallized windshield
- Impact resistant, molded plastic case
- Slim profile
- Non-battery for extended service life (AT5402)
- Dual-frequency (915 and 2450 MHz, AT5406)

## Specifications

### Frequency Range:

AT5402: 902 to 928 MHz

AT5406: 902 to 928 MHz/2425 to 2475 MHz

### Typical working range with TransCore® Encompass 4:

AT5402: 5 to 10 ft (1.5 to 3 m)

AT5406: 5 to 35 ft (1.5 to 11 m)

### Polarization:

Parallel with longer side

### Data Capacity:

Up to 10 alphanumeric characters (60 available bits) or Wiegand 26- to 54-bit formats

### Power Source:

AT5402: Beam-powered

AT5406: Lithium battery

### Dimensions:

AT5402: 3.6 x 2.3 x .27 in (9.2 x 5.9 x .69 cm)

AT5406: 4.5 x 2.5 x .7 in (11.4 x 6.4 x 1.8 cm)

### Weight:

AT5402: 1.4 oz. (40 g)

AT5406: 3.5 oz. (99 g)

### Service Life:

AT5402: >10 years

AT5406: Eight-year Lithium battery (typical life)

### Case Material:

Weatherproof, polycarbonate alloy, UV stabilized

### Mounting Surface:

Interior: Non-metallic windshield

### Mounting Method:

Semi-permanent mounting: Double-sided tape

Removable mounting: Adhesive-backed hook-and-loop material attached to the tag and vehicle windshield.

### Operating Temperature:

-40° F to 185° F (-40° C to 85° C)



157184



157185

## Part Number/Price

PART #	DESCRIPTION	PRICE
157184	AT5402 windshield tag beam power	\$40.00
157185	AT5406 windshield tag with battery	55.00

## RFID Transportation Tags

### Standard Features

- Harsh environment durability
- Factory sealed case
- Non-battery for extended service life (AT5412)
- Dual-frequency (915 and 2450 MHz, AT5414)

### Specifications

#### Frequency Range:

AT5412: 902 to 928 MHz

AT5414: 902 to 928 MHz/2425 to 2475 MHz

#### Typical Working Range with TransCore® Encompass 4:

AT5412: 5 to 10 ft (1.5 to 3 m)

AT5414: 5 to 35 ft (1.5 to 11 m)

#### Polarization:

Parallel with longer side

#### Data Memory Capacity:

SeGo and eGo Modes: 2048 bits

ATA Mode: 60 bits

#### Power Source:

AT5412: Beam

AT5414: Lithium battery for a typical eight-year life

#### Dimensions:

AT5412: 9.3 x 2.38 x 0.69 in (23.6 x 6.0 x 1.75 cm)

AT5414: 9.32 x 2.39 x 0.75 in (23.67 x 6.07 x 1.91 cm)

#### Weight:

AT5412: 5.3 oz (150.2 g)

AT5414: 6.6 oz (187 g)

#### Case Material:

Weatherproof, polycarbonate, UV-stabilized case that is sealed after programming

#### Mounting Surface:

Any smooth metallic surface

#### Mounting Method:

Mount to any flat smooth metal surface using bolts, screws or blind rivets

#### Operating Temperature:

-40° F to 185° F (-40° C to 85° C)



### Part Number/Price

PART #	DESCRIPTION	PRICE
86399	AT5412 transportation tag 1/2 frame beam power	\$60.00
157188	AT5414 transportation tag 1/2 frame with battery	75.00

## HID RFID Cards, Keys and Tags

### Standard Features

- Offer sufficient read/write memory to store multiple biometric templates
- Available in a two or 16 application-area configuration
- Offer multiple, securely separated areas to enable numerous applications, including the HID standard access control application
- Future growth for new read/write applications
- ISO 15693 and 14443B2 standards for read/write contactless communication
- Cost-effective way to enhance the security of your access control installation
- Close range



# HID RFID Readers

## Standard Features

- More powerful and versatile access control
- User-friendly proximity technology
- Uses the 13.56 MHz technology platform
- High-intensity, three color light bar provides clear, visual feedback even in direct sunlight
- Selectable, distinct tone sequences indicate status conditions
- All RF data transmission between the card and reader is encrypted using a secure algorithm
- Close range

## Specifications

### Typical Maximum Read Range\*:

- 2.5-4.5 in (6.3-11.4 cm) with HID iCLASS® card
- 1.0 in (2.5 cm) with HID iCLASS key
- 1.0 in (2.5 cm) with HID iCLASS tag
- 1.5-2.0 in (3.8-5.0 cm) with HID iCLASS prox
- 1-2 in (2.5-5.0 cm) with MIFARE® card (serial number only)

\*Using ISO 15693 mode (except MIFARE®). Dependent upon installation conditions. Please note that all iCLASS credentials are available in either a 2K bits (256 Bytes) or 16Kbits (2 KBytes) configuration.

### Dimensions:

- 3.30 x 4.80 x .85 in
- (8.38 x 12.19 x 2.16 cm)

### Material:

- UL94 polycarbonate

### Power Supply:

- 10-16VDC reverse voltage protected
- Linear supply recommended

### Current Requirements (Avg/Peak):

- 80/260 mA at 12VDC

### Operating Temperature:

- 31°F to 150°F (-35°C to 65°C)

### Operating Humidity:

- 5-95% relative humidity non-condensing

### Weight:

- 8.8 oz (249.5 g)

### Transmit Frequency:

- 13.56 MHz

### Cable Distance:

- Wiegand Interface-500 feet (150 m)
- Recommended cable is ALPHA 1295 (22AWG)
- Five-conductor stranded with overall shield or equivalent. Additional conductors may be required to connect all outputs.

### Pending Certifications:

- Taiwan, Singapore, Germany VdS

### Approvals:

- UL 294/cUL, FCC Certification, Canada Certification, CE Mark (Europe), New Zealand, Australia c-Tick



## Part Number/Price

PART #	DESCRIPTION	PRICE
85901	Class RW400 reader	\$495.00
88792	Power supply, IDEC 12VDC output, 85VAC input, required for 85901 above	135.00
85902	iClass Smart Card Pack 1-25 13.56 MHz	145.00
85903	iClass Smart Card Pack 26-50 13.56 MHz	145.00
85904	iClass Smart Card Pack 51-75 13.56 MHz	145.00
85905	iClass Smart Card Pack 76-100 13.56 MHz	145.00
156532	Photo-eye stand, 24 3/4 in H	195.00
95358	iClass Blank Smart Card (custom numbers)	6.00

Keyfob and disc tags optional—consult.

# Model G-89 Barrier Gate

## Standard Features

- Uses 1 in x 4 in soft pine wood
- Heavy duty aluminum construction with weather-proof gasketed door
- Built-in diagnostics
- Event history with differential counters
- True directional arming
- Up to three loop detector inputs
- Programmable time zone control of basic gate functions like override, raise/lower, enable/disable
- 1/3HP, 115VAC motor
- Sensitive reversing logic
- Internal heater



## Part Number/Price

PART #	DESCRIPTION	PRICE
82506	Gate, barrier; auto raise and lower with heater	\$8,365.00

## Photo Eyes

### Standard Features

- Many varieties available for both truck scale and dynamic weighing applications
- Arrange photo eyes to keep wheels on scale
- Rugged outdoor applications
- Reflective types work up to 17 ft (2.13 m) in clean conditions
- Quick disconnects for easy replacement
- Broken beams can signal a wheel off the scale or prevent a weighment in unattended systems
- Quick disconnects for easy replacement
- Transmitter/receiver types work up to 100 ft (30.48 m) in clean conditions

### Part Number/Price

PART #	DESCRIPTION	PRICE
<b>Photo Eyes</b>		
78975	Allen-Bradley® photo eye retro-reflective sensor	\$255.00
78976	Photo eye reflector, 3 in diameter	25.00
78977	Quick disconnect photo eye cable, 12 ft, 5-Pin mini connector	105.00
<b>Photo Switches</b>		
103013	Photo switch receiver	\$235.00
103014	Photo switch transmitter	185.00
103015	Photo switch quick connector receiver	105.00
103016	Photo switch quick connector transmitter	75.00
130398	Mounting swivel assembly for 103103 and 103014	21.00
156532	Photo eye stand kit	195.00



Retro-reflective



Photo Switches



# Traffic Light Kits

## Standard Features

- Tested to more than 80 mph wind loading on a single-point attachment
- Corrosion-resistant aluminum alloy coatings
- Stainless steel hardware

## Part Number/Price

PART #	DESCRIPTION	EST. SHIP WEIGHT	PRICE
23146	Traffic light kit, 8 in, 60 W, mounting hardware that mounts to a 4 in pipe, 115VAC	25 lb	\$710.00
117218	Traffic light kit, 3 section (red, yellow, green)	—	1,015.00
85789	Aluminum pole with base, 8 ft	70 lb	815.00
87111	Side mount brackets	10 lb	195.00
84504	Anchor bolt with nut washer	2lb	5.00
160242	Kit; dual traffic light		3,600.00
160208	Control panel, dual traffic light		710.00
156106	Buzzer box, 115 VAC		545.00

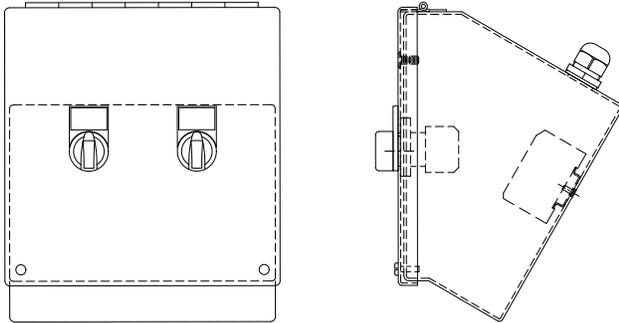

Control Panel Reference



Traffic Light



Buzzer Box

# Intercom AI PHONE

## Standard Features: Base Station

- Expanded master with high-powered
- 10W output for high noise areas
- One or two masters can be included
- Hands-free reply from remote area
- AP-1M or AP-5M master stations available, desk or wall mount
- Use 8 ohm horn speaker for maximum output, or wall or ceiling speaker sub stations
- Subs call master with LED and electronic tone
- Built-in power supply
- Special master units available for expanded capacity - up to five stations



Model AP-5M



Model AP-1M

## Specifications

### Power Source:

110-125VAC, 50.60 Hz communication sub calls in with tone and LED, Talk/Listen switch

### Communication:

10W, output

### Wiring:

Doors/subs/horns to master: two-cond., overall shield

### Distance:

Doors/subs/horns to master: 490 ft (22 AWG) 1,200 ft (18 AWG)

### Wire Type:

AI phone #822202 or AI phone #821802

Base Station

## Standard Features: Sub Station

- Moisture and puncture resistant speaker
- Three-layer steel baffle protects speaker from tampering
- Hands-free communication
- Unit fits standard two-gang electrical box
- Pigtail wires for connection to master station
- Weather and vandal resistant

Requires capacitor kit #107607



Sub Station

## Specifications

### Speaker:

20  $\Omega$ , 2 1/2 in diameter

### Wiring:

Shielded cable is recommended

### Wiring Distance:

650 ft with 22 awg  
1600 ft with 18 awg

### Communication:

Hands free at substation, master is push-to-talk, release-to-listen

### Dimensions:

4-11/16 H x 4-11/16 W x 2 in D

### Mounting:

Flush mount into 2-gang box or flush mount in kiosk

# Intercom AI PHONE

## Standard Features: Speaker/Horn

- Built-in 70V transformer, providing 1, 2, 4, 8 and 16 watt taps, + 8 ohms direct
- High intelligibility, used for paging into large or high noise areas
- All metal weatherproof construction designed for outdoor use
- Screwdriver selectable wattage taps
- Universal locking swivel mount

Requires capacitor kit #107607

## Specifications

### Power Handling Capacity:

16 watts (continuous)

### Impedance:

8 ohms direct, 25V or 70.7V transformer

### Wattage Taps:

70.7V: 1, 2, 4, 8 and 16W

25V: 0.5, 1, 2, 4 or 8W

### Frequency Response:

325-15,000Hz

### Dispersion Angle:

130°

### Sound Pressure Level:

119 dB at rated output measured 4 ft on axis

### Sensitivity As Microphone:

-28 dBm (Re: 10 dynes/cm<sup>2</sup>)

### Dimensions:

8 1/8 in bell x 9 in depth



Speaker/Horn

## Part Number/Price

PART#	DESCRIPTION	PRICE
107601	Base station, one-channel	\$1,095.00
107603	Base station, five-channel	1,635.00
107606	Sub station, LE-SS	405.00
107607	Kit, capacitor 25 uF, 25V	15.00
119757	Intercom, sub station Ethernet TCP/IP, requires 119760	475.00
119760	Adaptor, intercom over TCP/IP	965.00

## Options/Accessories

PART#	DESCRIPTION	PRICE
107604	Speaker/horn 8 ohm 119 dB, AH-16TN, requires capacitor kit 107607	\$135.00
158974	Single channel amplifier for Ethernet intercom	152.00



# Aviation

Table of Contents

**Tracer® AV** ..... **48**  
Baggage Weighing Instrumentation

**ESPAÑOL** | Visit [ricelake.com/spanish](http://ricelake.com/spanish)  
to see all RLWS materials  
available in Spanish

Product names, logos, brands, and other trademarks featured  
or referred to within this publication are the property of their respective trademark holders.

# Tracer® AV

## Baggage Weighing Instrumentation

Tracer AV combines a sleek two-button keypad, to select pounds or kilograms and re-zero, with the most durable stainless steel bagwell display. The simple-to-install bagwell display has large, bright LED characters and the rugged piezo keypad will endure years of busy check-in counter use.

Tracer AV components consist of a control box, cables, bagwell display(s) and keypad(s).

### Specifications

**Operator Key Pad:**

Stainless steel, panel mounted  
Two keys; zero and units

**Customer Interface:**

Stainless steel, panel mounted, 6-digit LED display, 0.8 in digits

**Enclosure:**

Bagwell display: 7.5 x 4.0 x 0.9 in  
A/D converter box: 10 x 5 x 2 in

**Voltage Input:**

115/230 VAC to power supply 50-60 Hz

**Serial Communications:**

RS-232 full duplex to host, up to 38.4 kbps,  
data 7 odd, 7 even, 8 none

**Remote Display Ports:**

19.2 kbps, data 8 none

**Load Cell Excitation:**

5VDC

**Analog Range:**

-0.5 mV/V to +4.5 mV/V

**A/D Sample Rate:**

Up to 60 per second

**Temperature Range:**

14° F to 104° F (-10° C to 40° C)

**Warranty:**

Two-year limited warranty

**Approvals:**

NTEP Certified 04-076, Class III 10,000 d  
cUL Marked



Ideal for aviation weighing. A complete system can be sold with the Benchmark™ LP or Benchmark HD.

### APPROVALS



### Standard Features

- Customer display (panel mount), control box supports two RD-1 displays
- Two-button keypad for ticket agent
- Flashing display for overweight bags

### Part Number/Price

PART #	DESCRIPTION	PRICE
98526	Tracer AV with single display, single keypad	\$1,375.00
98527	Tracer AV with dual display, single keypad	1,775.00
98528	Tracer AV with dual display, dual keypad	2,075.00

### Options/Accessories

PART #	DESCRIPTION	PRICE
93558	RD-1 panel mount display	\$425.00
108730	RD-1 external mount display	425.00
97995	Keypad, 2-button with cable	300.00
98316	Additional installation manual	25.00

# Balances

## Table of Contents

<b>Equipoise Series</b> .....	<b>20</b>	<b>Discovery™</b> .....	<b>73</b>
Compact Balance		Semi-Micro and Analytical Balances	
<b>TC Series</b> .....	<b>22</b>	<b>Pioneer™</b> .....	<b>75</b>
Tuning Fork Compact Balance		Analytical/Precision Balances	
<b>TP Series</b> .....	<b>24</b>	<b>Explorer®</b> .....	<b>77</b>
Tuning Fork Precision Balance		Analytical Balances	
<b>TS Series</b> .....	<b>26</b>	<b>Explorer®</b> .....	<b>79</b>
Tuning Fork Stainless Steel Balance		Precision	
<b>TA Series</b> .....	<b>28</b>	<b>Explorer® Pro</b> .....	<b>81</b>
Tuning Fork Analytical Balance		High Capacity	
<b>MC Series</b> .....	<b>30</b>	<b>Adventurer Pro®</b> .....	<b>83</b>
Mass Comparator		Precision Balances	
<b>Ion BM Series</b> .....	<b>32</b>	<b>MB Series</b> .....	<b>85</b>
Micro, Semi-Micro Analytical Balances		Moisture Analyzer	
<b>Phoenix GH Series</b> .....	<b>34</b>	<b>Scout Pro®</b> .....	<b>87</b>
Analytical/Semi-Micro Balances		Portable Electronic Balances	
<b>Gemini GR Series</b> .....	<b>36</b>	<b>CS Series</b> .....	<b>89</b>
Analytical/Semi-Micro		Compact Scale	
<b>HR-AZ/A Series</b> .....	<b>38</b>	<b>CL Series</b> .....	<b>90</b>
Analytical Balance		Compact Scale	
<b>Orion HR Series</b> .....	<b>40</b>	<b>HH Series</b> .....	<b>91</b>
Analytical/Semi-Micro		Handheld Compact Scale	
<b>AD-4212A Series</b> .....	<b>42</b>	<b>YA Series</b> .....	<b>92</b>
Analytical Balances		Pocket Scale	
<b>GX Series</b> .....	<b>45</b>	<b>Triple Beam</b> .....	<b>93</b>
Toploader Balances		Mechanical Balance	
<b>GF Series</b> .....	<b>48</b>	<b>Harvard Trip Balance</b> .....	<b>95</b>
Toploader Balances		Mechanical Beam	
<b>GF-P Series</b> .....	<b>51</b>	<b>Dial-O-Gram® and Cent-O-Gram®</b> .....	<b>96</b>
Toploader Balances		Mechanical Balances	
<b>FXi Series</b> .....	<b>52</b>	<b>Field Test Scale</b> .....	<b>97</b>
Toploader Balances		Mechanical Balance	
<b>FXi-WP Series</b> .....	<b>54</b>	<b>Heavy Duty Solution</b> .....	<b>98</b>
Toploader Balances		<b>FD Series</b> .....	<b>99</b>
<b>AD-1683</b> .....	<b>56</b>	Food Portioning Scale	
Static Eliminator		<b>Navigator™ XT</b> .....	<b>101</b>
<b>EJ Newton Series</b> .....	<b>57</b>	Battery-Operated Compact Scale	
Compact Balances		<b>Valor® 7000</b> .....	<b>102</b>
<b>EK-i Series</b> .....	<b>59</b>	Compact Bench Scales	
Compact Balances		<b>Valor® 3000 Xtreme</b> .....	<b>103</b>
<b>EW-i Series</b> .....	<b>62</b>	Compact Precision Scales	
Compact Balances		<b>Valor® 3000 Xtreme</b> .....	<b>104</b>
<b>GX-K Series</b> .....	<b>64</b>	Compact Washdown Scales	
Industrial Balances		<b>Valor® 2000</b> .....	<b>105</b>
<b>GF-K Series</b> .....	<b>66</b>	Compact Washdown Scales	
Precision Balances		<b>Valor® 1000</b> .....	<b>106</b>
<b>GP Series</b> .....	<b>68</b>	Compact Precision Scales	
Industrial Balances		<b>Cubis®</b> .....	<b>107</b>
<b>MS-70/MX-50/MF-50 Series</b> .....	<b>71</b>	Ultra-micro/Micro	
Moisture Analyzers		<b>Cubis®</b> .....	<b>109</b>
		Semi-Micro and Analytical Balances	
		<b>Cubis®</b> .....	<b>111</b>
		Milligram Balances	
		<b>Cubis®</b> .....	<b>113</b>
		Toploading Balances	

**ESPAÑOL** | Visit [ricelake.com/spanish](http://ricelake.com/spanish)  
to see all RLWS materials  
available in Spanish

Product names, logos, brands, and other trademarks featured or referred to within this publication are the property of their respective trademark holders.

# Balances

## Table of Contents

<b>CPA Series</b> .....	<b>116</b>
Micro Analytical Balances	
<b>Practum/Quintix/Secura</b> .....	<b>117</b>
Analytical	
<b>Practum/Quintix/Secura</b> .....	<b>119</b>
Precision	
<b>Entris</b> .....	<b>121</b>
<b>AbleCable®</b> .....	<b>124</b>
<b>go-between</b> .....	<b>125</b>
Data Capture and Storage	
<b>Standard Balance Slab</b> .....	<b>126</b>
<b>Clean Room Table</b> .....	<b>126</b>
Granite	
<b>Scoops</b> .....	<b>126</b>
Kasota Stone	
<b>Standard Balance Table</b> .....	<b>126</b>
Kasota Stone	
<b>Anti-Vibration</b> .....	<b>126</b>
<b>Prove™ Statistical Printer</b> .....	<b>127</b>





**Standard Features**

- Capacities between 300 g and 6000 g
- Internal resolution: 1/600,000
- LCD display
- Quick response
- Accumulation, counting and percentage modes
- 13 different units of measure
- Detachable enclosed weighing chamber (in capacities ≤1 kg)
- Battery operation for up to 40 hours of continuous use (without backlight)
- Standard RS-232 interface for connecting to printer or PC
- Plastic enclosure
- AC adapter

**Approvals****Specifications**

	EQ-300 <sup>^</sup>	EQ-600 <sup>^</sup>	EQ-1500	EQ-3000	EQ-6000
<b>Part #</b>	<b>129410</b>	<b>129411</b>	<b>129412</b>	<b>129413</b>	<b>132435</b>
<b>List Price</b>	<b>\$285.00</b>	<b>\$285.00</b>	<b>\$285.00</b>	<b>\$285.00</b>	<b>\$295.00</b>
Capacity	300 g	600 g	1500 g	3000 g	6000 g
<b>Resolution</b>	<b>0.01 g</b>	<b>0.02 g</b>	<b>0.05 g</b>	<b>0.1 g</b>	<b>0.2 g</b>
Weighing Units	Gram, Carat, Ounce, Ounce Troy, Pound, Pennyweight, Grain, Momme, Hong Kong Tael, Singapore Tael, Taiwan, Tael, tola				
Operating Modes	Weighing, Percent Weighing, Parts Counting, Accumulation				
Repeatability(+/-)	0.01 g	0.02 g	0.05 g	0.1 g	0.2 g
Linearity(+/-)	0.02 g	0.04 g	0.1 g	0.2 g	0.4 g
Stabilization Time	2 seconds				
Operating Temperature	32° F to 104° F (0° C to 40° C)				
Weighing Chamber	6.7 x 5.7 x 3.1 in (170 x 145 x 80 mm)		N/A	N/A	N/A
<b>Pan Size</b>	<b>Ø 4.7 in (Ø 120 mm)</b>		<b>4.8 in x 5.6 in (122 mm x 142 mm)</b>		
Dimensions	7.1 x 8.7 x 3.3 in (180 x 220 x 85 mm)				
Est. Ship Weight	6.6 lb (3 kg)				
Calibration Weight	300 g	600 g	1500 g	3000 g	6000 g
Power	AC adapter (12V/500 mA); internal rechargeable battery (6V/1.2Ah)				
Warranty	One-year limited warranty				
Return Policy	Rice Lake Standard Policy				

<sup>^</sup>Weighing Chamber

Rice Lake

## Equipoise Series

Compact Balance

### Part Number/Price

PART #	MODEL #	CAPACITY	EST SHIP WEIGHT	PRICE
129410	EQ-300	300 g x 0.01 g	6 lb	\$285.00
129411	EQ-600	600 g x 0.02 g	6 lb	285.00
129412	EQ-1500	1500 g x 0.05 g	6 lb	285.00
129413	EQ-3000	3000 g x 0.1 g	6 lb	285.00
132435	EQ-6000	6000 g x 0.2 g	6 lb	295.00

### Options/Accessories

PART #	DESCRIPTION	PRICE
41279	Printer cable, DB9M to 25-Pin M	\$65.00
103141	SP712 dot matrix printer, tear bar	350.00
130789	Null modem adapter DBF/M	12.00
158056	Prove statistical printer	715.00
129425	AC Adapter, 110-240 VAC	35.00
119919	AbleCable RS-232/USB cable (requires 130789)	185.00
130789	Slim line null modem adapter	12.00
131135	Aluminum case	100.00
165183	AC adapter, 110-240VAC, interchangeable plugs	45.00

BALANCES

www.ricelake.com | Phone: 800-472-6703

RICE LAKE

## Tuning Fork Compact Balance

**Standard Features**

- Large 16.5 mm high Liquid Crystal Backlit Display (LCD)
- Selectable modes: weight, unit count and percentage
- 12 units of measurement
- Mono-Metal Tuning Fork Sensor (MMTS) provides quick response and stability
- 20-step bar graph display
- 115VAC adapter included (230VAC optional)
- Semi-automatic calibration, external weight
- Plastic housing on models < 1000g, plastic top and die cast bottom on models > 1000g

**Optional Features**

- RS-232
- Rechargeable battery

**Specifications**

	TC-620	TC-1200	TC-4200	TC-6200
<b>Part#</b>	<b>107232</b>	<b>107233</b>	<b>107234</b>	<b>107235</b>
<b>List Price</b>	<b>\$700.00</b>	<b>\$640.00</b>	<b>\$700.00</b>	<b>\$755.00</b>
Capacity	620 g	1200 g	4200 g	6200 g
<b>Resolution</b>	<b>0.01 g</b>	<b>0.1 g</b>	<b>0.1 g</b>	<b>0.1 g</b>
Operating Modes	Count, Percentage, Limit Function (Checkweighing)			
Repeatability	1 division			
Linearity	1 division			
Operating Temperature	41° F to 95° F (5° C to 35° C)			
<b>Pan Size</b>	<b>Ø 5.5 in (139.7 mm)</b>	<b>6.7 in x 5.6 in (170.2 x 142.2 mm)</b>	<b>7 in x 6.2 in (177.8 x 157.5 mm)</b>	
Dimensions	9.2 x 7.1 x 2.9 in (234 x 180 x 74 mm)	10.4 x 7.5 x 3.4 in (264 x 191 x 86 mm)		
Weight (Approx.)	2.9 lb (1.3 kg)		5.9 lb (2.7 kg)	
Calibration Weight	600 g	1200 g	4000 g	6200 g
Power	120 VAC adapter			
Warranty	Five-year limited warranty			
Return Policy	Rice Lake Standard Policy			
Decimal Ounce	21 x 0.0005 oz	42 x 0.005 oz	140 x 0.005 oz	210 x 0.005 oz
Decimal Pound	1.3 x 0.00005 lb	2.6 x 0.0005 lb	9.2 x 0.0005 lb	13 x 0.0005 lb
Troy Ounce	19 x 0.0005 ozt	38 x 0.005 ozt	130 x 0.005 ozt	190 x 0.005 ozt
Pennyweight	390 x 0.01 dwt	770 x 0.1 dwt	2700 x 0.1 dwt	3900 x 0.1 dwt
Carat	3100 x 0.05 ct	6000 x 0.5 ct	21000 x 0.5 ct	31000 x 0.5 ct
Momme	160 x 0.005 mom	320 x 0.05 mom	1100 x 0.05 mom	1600 x 0.05 mom
Grain Unit	9500 x 0.2 GN	18000 x 2 GN	64000 x 2 GN	95000 x 2 GN
ti (Hong Kong)	16 x 0.0005	32 x 0.005	110 x 0.005	160 x 0.005
ti (Singapore, Malaysia, Taiwan)	16 x 0.0005	31 x 0.005	110 x 0.005	160 x 0.005
to	53 x 0.001	100 x 0.01	360 x 0.01	530 x 0.01

UNIT OF MEASURE

Rice Lake

## TC Series

Tuning Fork Compact Balance

### Part Number/Price

PART #	MODEL #	DESCRIPTION	PRICE
107232	TC-620	620 g x 0.01 g	\$700.00
107233	TC-1200	1200 g x 0.1 g	640.00
107234	TC-4200	4200 g x 0.1 g	700.00
107235	TC-6200	6200 g x 0.1 g	755.00

### Options/Accessories

PART #	DESCRIPTION	PRICE
107236	Rechargeable battery-TC-620, TC-1200, 32 hr	\$100.00
107237	Rechargeable battery-TC-4200, TC-6200, 32hr	100.00
107238	RS-232 option with DIN-5-Pin connector (not compatible with battery option) (TC-620, TC-1200)	125.00
107239	RS-232 option with DIN-5-Pin connection (not compatible with battery option, (TC-4200,TC-6200)	125.00
107240	In-use dust cover, 220 to 1200 g	25.00
107250	In-use dust cover, 2200 to 12 kg	25.00
109236	Underweigh hook TC-620, TC-1200	25.00
109292	Underweigh hook TC-4200, TC-6200	25.00
42566	120VAC adapter	50.00
42168	230VAC adapter	70.00
107243	Additional operating manual	15.00
75351	WinWedge software	325.00
115303	5-Pin to 9-Pin RS-232 cable	95.00
115148	RS-232 manual	5.00

**Standard Features**

- External weight calibration
- Large 16.5 mm high LCD (Liquid Crystal Backlit Display)
- Selectable modes: weight, unit, count and percentage
- 12 units of measurement
- Mono-Metal Tuning Fork Sensor (MMTS) provides quick response and stability
- 20-step bar graph display
- 115VAC adapter included (230VAC optional)
- One part in 620,000 resolution
- RS-232 bidirectional
- Plastic housing on models < 1000g, plastic top and die cast bottom on models > 1000g



**Optional Features**

- Rechargeable battery
- NTEP Certified models

**Approvals**



**Specifications**

	TP-220 <sup>^</sup>	TP-420NT <sup>^</sup>	TP-820	TP-1200NT	TP-3200	TP-4200NT	TP-6200NT	TP-8200	TP-12K
<b>Part#</b>	107244	-	107245		107246	-		107247	107248
<b>List Price</b>	\$1,000.00	-	\$1,000.00		\$1,130.00	-		\$1,000.00	\$1,150.00
<b>NTEP</b>	<b>Part#</b>	-	108155	-	163604	-	108154	163606	-
	<b>List Price</b>	-	\$1,100.00	-	\$950.00	-	\$1,100.00	\$1,425.00	-
<b>Capacity</b>	220 g	420 g	820 g	1200 g	3200 g	4200 g	6200 g	8200 g	12000 g
<b>Resolution</b>	0.001 g	0.001 g	0.01 g	0.01 g	0.01 g	0.01 g	0.01 g	0.1 g	0.1 g
<b>Operating Modes</b>	Counting, Percentage, Limit Function (checkweighing)								
<b>Repeatability</b>	1 division								
<b>Linearity</b>	1 division								
<b>Operating Temperature</b>	41° F to 95° F (5° C to 35° C)								
<b>Pan Size</b>	Ø 4.6 in (116.8 mm)		6.6 in x 5.5 in (167.6 x 139.7 mm)			7 in x 6.2 in (177.8 x 157.5 mm)			
<b>Dimensions</b>	9.2 x 7.1 x 6.6 in (including windshield) (235 x 182 x 170 mm)		9.2 x 7.1 x 2.9 in (235 x 182 x 75 mm)			10.1 x 7.5 x 3.4 in (265 x 192 x 87 mm)			
<b>RS-232 Specifications</b>	Baud rate - 1200/2400/2800/9600; Data bits - 8, Connector - DIN 5-Pin								
<b>Est. Ship Weight</b>	2.9 lb (1.3 kg)				6.2 lb (2.8 kg)				
<b>Calibration Weight</b>	200 g	400 g	800 g	1000 g	3000 g	4000 g	6000 g	8000 g	12000 g
<b>Power</b>	120VAC adapter								
<b>Battery Option</b>	Nickel Cadmium battery, 12-hour run time, 24 hour charge time								
<b>Approvals</b>		NTEP Class II		NTEP Class II		NTEP Class II			
<b>Warranty</b>	Five-year limited warranty								
<b>Return Policy</b>	Rice Lake Standard Policy								
<b>Decimal Ounce</b>	7.7 x 0.00005 oz	14 x 0.001 oz	28 x 0.0005 oz	42 x 0.0005	110 x 0.0005 oz	140 x 0.01 oz	210 x 0.001	280 x 0.005 oz	420 X 0.005 oz
<b>Decimal Pound</b>	0.48 x 0.00001 lb	0.92 x 0.00001 lb	1.8 x 0.00005 lb	2.6 x 0.00005	7.0 x 0.00005 lb	9.2 x 0.0001 lb	13 x 0.0001	18 x 0.0005 lb	26 x 0.0005 lb
<b>Troy Ounce</b>	7 x 0.00005 ozt	16 x 0.0001 ozt	26 x 0.0005 ozt	38 x 0.0005	100 x 0.0005 ozt	130 x 0.001 ozt	190 x 0.001	260 x 0.005 ozt	380 x 0.005 ozt
<b>*Pennyweight</b>	140 x 0.001 dwt		520 x 0.01 dwt	770 x 0.01	2000 x 0.01 dwt	2700 x 0.01	3900 x 0.01	5200 x 0.1 dwt	7700 x 0.1 dwt
<b>Carat</b>	1100 x 0.01 ct	2100 x 0.01 ct	4100 x 0.05 ct	6000 x 0.05	160000 x 0.05 ct	21000 x 0.1 ct	31000 x 0.1	41000 x 0.5 ct	60000 x 0.5 ct
<b>Momme</b>	58 x 0.0005 mom		210 x 0.005 mom	320 x 0.005	850 x 0.01 mom	1100	1600 x 0.01	2100 x .05 mom	3200 x 0.05 mom
<b>Grain Unit</b>	3300 x 0.02 GN	6400 x 0.02 GN	12000 x 0.2 GN	1200 x 0.01	48000 x 0.2 GN	64000 x 0.2 GN	95000 x 0.2	120000 x 2 GN	180000 x 2 GN
<b>ti</b>	5.8 x 0.00005		21 x 0.0005		85 x 0.001			210 x 0.005	320 x 0.005
<b>to</b>	18 x 0.0001		70 x 0.001	100 x 0.001	270 x 0.001		530 x 0.001	700 x 0.01	1000 x 0.01
<b>Measurable Unit Weight</b>	0.03 g	0.03 g	0.03 g	0.01 g	0.3 g	0.3 g	0.01 g	3g	3g

<sup>^</sup>Weighing Chamber

\*Pennyweight is not an NTEP supported unit of measurement

Rice Lake

## TP Series

Tuning Fork Precision Balance

### Part Number/Price

PART #	MODEL #	DESCRIPTION	PRICE
107244	TP-220	220 g x 0.001 g	\$1,000.00
108155	TP-420NT	420 g x 0.001 g	1,100.00
107245	TP-820	820 g x 0.01 g	1,000.00
163604	TP-1200NT	1200 g x 0.01 g	950.00
107246	TP-3200	3200 g x 0.01 g	1,130.00
108154	TP-4200NT	4200 g x 0.01 g	1,100.00
163606	TP-6200NT	6200 g x 0.01 g	1,425.00
107247	TP-8200	8200 g x 0.1 g	1,000.00
107248	TP-12K	12000 g x 0.1 g	1,150.00

### Options/Accessories

PART #	DESCRIPTION	PRICE
107249	Rechargeable battery ≤ TP1200	\$100.00
107237	Rechargeable battery ≥ TP-3200	100.00
107250	In-use dust cover ≥ TP-3200	25.00
107240	In-use dust cover ≤ TP-1200	25.00
42566	115VAC adapter	50.00
42168	230VAC adapter	70.00
107251	Additional operating manual	15.00
75351	WinWedge Tal software	325.00
115303	5-Pin to 9-Pin DB female RS-232 cable	95.00
109236	Underweigh hook ≤ TP-1200	25.00
109292	Underweigh hook ≥ TP-3200	25.00
158056	Prove statistical printer (requires cable)	715.00
158583	Cable, RJ11 to 5-Pin DIN	65.00

BALANCES

www.ricelake.com | Phone: 800-472-6703

RICE LAKE

## Tuning Fork Stainless Steel Balance

**Standard Features**

- Stainless steel, IP65 top housing
- Large 18 mm Liquid Crystal Display (LCD) with backlight
- Selectable modes
- 13 units of measurement
- MMTS (Mono-Metal Tuning Fork Sensor) provides quick response and stability
- IP65
- 115 VAC adapter included (230 VAC optional)
- Semi-automatic calibration, external weight
- RS-232 bidirectional

**Optional Features**

- Battery
- Underweigh hook
- Waterproof RS-232 cable

**Specifications**

	TS-620	TS-6200	TS-8200	
<b>Part#</b>	<b>108156</b>	<b>108157</b>	<b>112182</b>	
<b>List Price</b>	<b>\$1,300.00</b>	<b>\$1,400.00</b>	<b>\$1,475.00</b>	
Capacity	620 g	6200 g	8200 g	
<b>Resolution</b>	<b>0.01 g</b>	<b>0.1 g</b>	<b>0.1 g</b>	
Operating Modes	Counting, Percentage, Limit Function (Checkweighing), Weighing multiplied by coefficient, specific gravity, animal weighing, adding multiple measurements			
Repeatability	1 division			
Linearity	1 division			
Operating Temperature	0° C to 40° C 80% RH or less			
<b>Pan Size</b>	<b>Ø 140 mm (5.51 in)</b>	<b>190 x 190 mm (7.48 X 7.48 in)</b>		
RS-232 Specifications	Baud rate - 1200/2400/4800/9600/19200, Data bits 8/7; Connector - 9-Pin D-Sub M (not IP65 unless using PN 109238 cable)			
Dimensions	12.2 x 8.2 x 3.4 in (310 x 208 x 87 mm)			
Weight (Approx.)	10 lb (4.5 kg)			
Calibration Weight*	600 g	6000 g	8000 g	
Power	120V AC adapter			
Battery Option	Field installable, uses 4AA dry cell batteries			
Warranty	Five-year limited warranty			
Return Policy	Rice Lake Standard Policy			
UNIT OF MEASURE	Decimal Ounce	21 x 0.0005 oz	210 x 0.005 oz	280 x 0.005 oz
	Decimal Pound	1.3 x 0.00005 lb	13 x 0.0005 lb	18 x 0.0005 lb
	Troy Ounce	19 x 0.0005 ozt	190 x 0.005 ozt	260 x 0.005 ozt
	Pennyweight	390 x 0.01 dwt	3900 x 0.1 dwt	5200 x 0.1 dwt
	Carat	3100 x 0.05 ct	31000 x 0.5 ct	41000 x 0.5 ct
	Momme	160 x 0.005 mom	1600 x 0.05 mom	2100 x 0.05 mom
	Grain Unit	9500 x 0.2 GN	95000 x 2 GN	120000 x 2 GN

\* Calibration of balance does not require weight of full capacity (adjustable)



Rice Lake

## TS Series

Tuning Fork Stainless Steel Balance

### Part Number/Price

PART #	MODEL #	DESCRIPTION	PRICE
108156	TS-620	620 g x 0.01 g	\$1,300.00
108157	TS-6200	6200 g x 0.1 g	1,400.00
112182	TS-8200	8200 g x 0.1 g	1,475.00

### Options/Accessories

PART #	DESCRIPTION	PRICE
108498	AC adapter, 6VDC/120 VAC	\$50.00
108499	AC adapter, 6VDC/230 VAC	70.00
72440	9-Pin D-sub F-25-Pin D-sub connector	65.00
22436	9-Pin D-sub F to blunt end	55.00
66535	Null modem cable	45.00
119064	Slimline adapter, null modem gender changer	10.50
109236	Under weigh hook	25.00
109238	Waterproof RS-232 cable	350.00
109050	Additional operating manual	15.00
112611	Battery operator manual	5.00
112516	Battery option	100.00
119919	Able Cable, requires Null modem adapter	185.00

BALANCES

www.ricelake.com | Phone: 800-472-6703

RICE LAKE

## Standard Features

- Anti-electric 360° transparent windshield
- Eight digit 16.5 mm high Liquid Crystal Display (LCD) with backlight
- Single-touch response setting for environment
- 40-step bar graph display
- RS-232C interface
- ISO/GLP/GMP compliant printing record
- Underweigh hook included
- Internal calibration
- Plastic housing



## Specifications

	TA-120 <sup>^</sup>	TA-220 <sup>^</sup>
<b>Part#</b>	<b>107396</b>	<b>107397</b>
<b>List Price</b>	<b>\$1,935.00</b>	<b>\$1,955.00</b>
Capacity	120 g	220 g
<b>Resolution</b>	<b>0.0001 g</b>	<b>0.0001 g</b>
Operating Modes	Counting, Percentage, Limit Function (checkweighing), Specific gravity,	
Repeatability	1 division	
Linearity	1 division	
Operating Temperature	50° F to 86° F (10° C to 30° C) 80% RH or lower	
RS232 Specifications	Baud rate - 1200/2400/4800/9600/19200 bps, 8/7 data bits, Parity bit-None/Odd/Even	
<b>Pan Size</b>	<b>Ø 3.15 in (80 mm)</b>	
Dimensions	11 x 7.9 x 12 in (290 x 200 x 306 mm)	
Weight (Approx.)	6.4 lb (2.9 kg)	
Calibration Weight	100 g	200 g
Power	120VAC adapter	
Warranty	Five-year limited warranty	
Return Policy	Rice Lake Standard Policy	
UNIT OF MEASURE		
Decimal Ounce	4.2 x 0.000005 oz	7.7 x 0.000005 oz
Decimal Pound	0.26 x 0.000001 lb	.48 x 0.000001 lb
Troy Ounce	3.8 x 0.000005 ozt	7 x 0.000005 ozt
Pennyweight	77 x 0.0001 dwt	140 x 0.0001 dwt
Carat	600 x 0.0005 ct	1100 x 0.001 ct
Momme	32 x 0.00005 mom	58 x 0.00005 mom
Grain Unit	1800 x 0.002 GN	3300 x 0.002 GN
TI	3.2 x 0.000005	5.8 x 0.00005
Tola	10 x 0.00001 to	18 x 0.00001 to

<sup>^</sup> Weighing Chamber

Rice Lake

## TA Series

Tuning Fork Compact Balance

### Part Number/Price

PART #	MODEL #	DESCRIPTION	PRICE
107396	TA-120	120 g x 0.0001 g	\$1,935.00
107397	TA-220	220 g x 0.0001 g	1,955.00

### Options/Accessories

PART #	DESCRIPTION	PRICE
108255	115VAC adapter	\$50.00
108256	230VAC adapter	75.00
108257	In-use cover	50.00
107398	Additional operating manual	15.00
75351	WinWedge® Tal software	325.00
66535	Null modem RS-232 cable	45.00
119919	Able Cable, requires null modem adapter	185.00
158056	Prove statistical printer	715.00

BALANCES

www.ricelake.com | Phone: 800-472-6703

RICE LAKE

## Standard Features

- Super hybrid sensor technology
- Bright VFD display
- Manage ASTM & OIML weights
- Auto-centering pan options
- Standard underhook
- Built-in calibration weight
- GLP/LIM/ISO compliant
- RS-232C standard



## Specifications

	MC-1000 <sup>^</sup>	MC-6100 <sup>^</sup>	MC-10K <sup>^</sup>	MC-30K <sup>^</sup>
<b>Part #</b>	<b>151262</b>	<b>151263</b>	<b>151264</b>	<b>151265</b>
<b>List Price</b>	<b>\$5,495.00</b>	<b>\$5,495.00</b>	<b>\$6,495.00</b>	<b>\$6,495.00</b>
Capacity	1100 g	6100 g	10.1 kg	31 kg
<b>Resolution</b>	<b>0.1 mg</b>	<b>0.001 g</b>	<b>0.001 g</b>	<b>0.01 g</b>
Operating Modes	Weighing, Percentage, Comparator			
Weighing Units	g, oz, lb, lb-oz, troy oz, ct, dwt, grain, momme			
Repeatability**	0.0005 g/1 kg/0.0004 g/500 g	0.004 g/5 kg/0.0015 g/2 kg	0.005 g/10 kg/0.004 g/5 kg	0.015 g/20 kg
Linearity	±0.002 g	±0.02 g	±0.03 g	±0.2 g
Stabilization Time	5 seconds			
Sensitivity Drift (10° C-30° C)	±2ppm/° C			±3ppm/0° C
Operating Temperature	41° F to 104° F (5° C to 40° C) 85% RH or less (no condensation)			
<b>Pan Size</b>	<b>128 x 128 mm</b>	<b>165 x 165 mm</b>	<b>270 x 210 mm</b>	
Physical Dimensions	210 x 317 x 86 mm		300 x 355 x 111 mm	
Weight	4.6 kg	5.1 kg	9.3 kg	
Ext. Cal. Mass (optional)	1000 g	6000 g	10 kg	30 kg
Power	120/240 AC adapter			
Warranty	Five-year limited warranty			
Return Policy	A&D Weighing Standard Policy - restock fee may apply			

<sup>^</sup> Weighing Chamber

\*\* Repeatability when auto-centering is used under good ambient conditions

### Part Number/Price

PART #	MODEL #	DESCRIPTION	PRICE
151262	MC-1000	1100 g x 0.1 mg, Glass Breeze Break	\$5,495.00
151263	MC-6100	6100 g x 0.001 g, Glass Breeze Break	5,495.00
151264	MC-10K	10.1 kg x 0.001 g, Breeze Break	6,495.00
151265	MC-30K	31 kg x 0.01 g, Breeze Break	6,495.00

### Options/Accessories

PART #	MODEL #	DESCRIPTION	PRICE
151266	AX-MC1000PAN	Auto center pan, MC-1000	\$1,117.00
151267	AX-MC6100PAN	Auto center pan, MC-6100	1,117.00
151268	AX-MC10K-30KPAN	Auto center pan, MC-10/30K	1,425.00
151247	AD-1688	Data logger	295.00
97649	TB-248	AC adapter, 120/240V	41.00
97695	GX-04*	Comparator output, factory installed	255.00
97696	GX-06*	Analog output, factory installed	815.00
97699	GX-12	Animal weigh pan	180.00
97700	GX-13	Density determination for MC-1000	623.00
97607	AD-1682	External rechargeable battery pack	658.00
97612	SW-128	Foot switch	72.00
158785	AD-8121B	Impact dot-matrix printer, statistical function, includes 25-Pin cable	865.00

\* Only one option may be installed

A & D Weighing  
**Ion BM Series**

Micro, Semi-Micro Analytical Balances

Capacity: 520g Readability: 0.000001g

BALANCES

**Standard Features**

- Built-in fanless static eliminator
- Standard underhook
- Anti-static glass
- Built-in motorized calibration weight
- One touch environmental filters
- GLP/LIM/ISO compliant
- RS-232C and WinCT software standard
- AD-1688 Weighing Data Logger included



**Specifications**

	BM-20 <sup>^</sup>	BM-22 <sup>^</sup>	BM-252 <sup>^</sup>	BM-200 <sup>^</sup>	BM-300 <sup>^</sup>	BM-500 <sup>^</sup>	
<b>Part#</b>	150762	150763	150765	150766	150767	150768	
<b>List Price</b>	\$13,995.00	\$12,995.00	\$7,995.00	\$6,295.00	\$6,595.00	\$6,995.00	
Capacity (g)	22	22/5.1	250	220	320	520	
<b>Resolution (g)</b>	<b>0.000001</b>	<b>0.00001/0.000001</b>	<b>0.00001</b>	<b>0.0001</b>	<b>0.0001</b>	<b>0.0001</b>	
Operating Modes	Percentage, Counting						
Repeatability	0.0025 mg	0.004 mg/0.01 mg	0.03 mg	0.1 mg	0.2 mg		
Linearity	±0.010 mg	±0.010/0.02 mg	±0.010 mg	±0.2 mg	±0.3 mg	±0.5 mg	
Stabilization Time	10 seconds (typically)	8 to 10 seconds	8 seconds	Approx. 3.5 seconds			
Sensitivity Drift (10° C-30° C)	±2ppm/° C (when automatic self calibration is not used)						
Operating Temperature	41° F to 104° F (5° C to 40° C), 85% RH or less (no condensation)						
<b>Pan Size</b>	<b>Ø 0.98 inches (25 mm)</b>		<b>Ø 3.6 inches (90 mm)</b>				
Physical Dimensions	10.2 x 18.3 x 12.8 in (259 x 466 x 326 mm)						
Weight	10 kg (ships by motor freight)						
Ext. Cal. Mass (optional)	20 g		200 g	200 g	300 g	500 g	
Power	120/240 AC Adapter						
Warranty	Five-year limited warranty						
Return Policy	A&D Weighing Standard Policy - restock fee may apply						
UNIT OF MEASURE	Decimal Ounce	0.776 x 0.00000001	0.18/0.776 x 0.0000001/0.000001	8.82 x 0.000001	7.76 x 0.000001	11.29 x 0.000001	18.34 x 0.000001
	Troy Ounce	0.707 x 0.00000001	0.164/0.707	8.03 x 0.00000001	7.07 x 0.00000001	10.29 x 0.00000001	16.72 x 0.00000001
	Pennyweight	14.15 x 0.000001	3.28/14.15 x 0.000001 x 0.0001	160.7 x 0.000001	141.5 x 0.000001	20.58 x 0.000001	334.4 x 0.000001
	Carat	110 x 0.000001	25.5/110 x 0.000001/0.0001	1250 x 0.000001	1100 x 0.000001	1600 x 0.000001	2600 x 0.000001
	Momme	5.87 x 0.00000001	1.37/5.87 x 0.0000001/0.000001	66.67 x 0.00000001	58.7 x 0.00000001	85.3 x 0.00000001	138.7 x 0.00000001
	Grain Unit	339.5 x 0.000002	78.71/339.5 x 0.000002/0.0002	3858x0.0002	3395x0.0002	4938x0.0002	8024x 0.0002

<sup>^</sup> Weighing Chamber

www.ricelake.com | Phone: 800-472-6703

RICE LAKE

A & D Weighing

## Ion BM Series

Micro, Semi-Micro Analytical Balances

### Part Number/Price

PART #	MODEL #	DESCRIPTION	PRICE
150762	BM-20	22 g x 0.001 mg	\$13,995.00
150763	BM-22	5.1 g/22 g x 0.001 mg/0.01 mg	12,995.00
150765	BM-252	250 g x 0.01 mg	7,995.00
150766	BM-200	220 g x 0.1 mg	6,295.00
150767	BM-300	320 g x 0.1 mg	6,595.00
150768	BM-500	520 g x 0.1 mg	6,995.00

### Options/Accessories

PART #	MODEL #	DESCRIPTION	PRICE
150769	BM-08	Balance OPT, Ethernet BM	\$810.00
97606	AD-1653	Density determination kit (BM-252/200/300/500 only)	535.00
97609	AD-8922A	Remote controller	615.00
97608	AD-8920A	Universal remote display	260.00
97612	SW:128	Foot switch	72.00
97649	TB:248	AC adapter 120V/220V	41.00
158785	AD-8121B	Dot-matrix statistical printer, includes 25-Pin cable	865.00

## Standard Features

- Simple and easy to operate, adapts to your environment
- GLP/GMP/GCP/ISO compliant which outputs the calibration data and ID number of the balance for calibration confirmation to the AD-8121B printer
- Internal calibration mass; full digital calibration
- System diagnostic to alert operator of abnormal weighing conditions
- Underhook capability for density determination and weighing magnetic substances
- RS-232C bidirectional interface
- Data memory function
- Time and date function
- WinCT® communication tools software
- Liquid Crystal Display (LCD)



## Specifications

	GH-120 <sup>^</sup>	GH-200 <sup>^</sup>	GH-300 <sup>^</sup>	GH-202 <sup>^</sup>	GH-252 <sup>^</sup>	
<b>Part#</b>	<b>97597</b>	<b>97599</b>	<b>97600</b>	<b>97601</b>	<b>97602</b>	
<b>List Price</b>	<b>\$3,435.00</b>	<b>\$3,895.00</b>	<b>\$4,625.00</b>	<b>\$5,195.00</b>	<b>\$5,725.00</b>	
Capacity	120 g	220 g	320 g	220/51 g	250/101 g	
<b>Resolution</b>	<b>0.0001 g</b>	<b>0.0001 g</b>	<b>0.0001 g</b>	<b>0.0001/ 0.00001 g</b>	<b>0.0001/ 0.00001 g</b>	
Operating Modes	Percentage, Counting					
Repeatability	±0.2 mg	±0.2 mg	±0.3 mg	±0.2 mg/±0.03 mg	±0.2 mg/±0.10 mg	
Linearity	0.1 mg	0.1 mg	0.2 mg	0.1 mg/0.02 mg	0.1 mg/0.03 mg	
Stabilization Time	Approx. 3.5 sec (0.1 mg)/8 sec (0.01 mg)					
Sensitivity Drift (10° C-30° C)	±2 ppm/° C (when automatic self calibration is not used)					
Operating Temperature	41° F to 104° F (5° C to 40 C) 85% RH or less (no condensation)					
<b>Pan Size</b>	<b>Ø 3.6 in (90 mm)</b>					
Physical Dimensions	8.54 W x 17.4 D x 12.24 in H (217 x 442 x 316 mm)					
Weighing Chamber	6.45 W x 4.87 D x 9.88 in H (164 x 148.5 x 251 mm)					
Weight	Approx. 18 lb (8.2 kg)					
Ext. Cal. Mass (optional)	50 g/100 g	100 g/200 g	100 g/200 g/300 g	20 g/50 g/100 g/200 g		
Power	120V AC (AC Adapter) 50 Hz/60 Hz, 11 VA (110, 220, 240 available by special order)					
Warranty	Five-year limited warranty					
Return Policy	A&D Weighing Standard Policy - restock fee may apply					
UNIT OF MEASURE	Decimal Ounce	4.23 x 0.00001 oz	7.76 x 0.00001 oz	11.29 x 0.00001 oz	7.76 x 0.00001/1.80 x 0.000001 oz	8.82 x 0.00001/3.56 x 0.000001 oz
	Troy Ounce	3.86 x 0.00001 ozt	7.07 x 0.00001 ozt	10.29 x 0.00001 ozt	7.07 x 0.00001/1.64 x 0.000001 ozt	8.04 x 0.00001/3.25 x 0.000001 ozt
	Pennyweight	77.2 x 0.0001 dwt	141.5 x 0.0001 dwt	205.8 x 0.0001 dwt	141.5 x 0.0001/32.8 x 0.00001 dwt	160.8 x 0.0001/64.9 x 0.00001 dwt
	Carat	600 x 0.001 ct	1100 x 0.001 ct	1600 x 0.001 ct	1100 x 0.001/255 x 0.0001 ct	1250 x 0.001/505 x 0.0001 ct
	Momme	32.0 x 0.0001 mom	58.7 x 0.0001 mom	85.3 x 0.0001 mom	58.7 x 0.0001/13.6 x 0.00001 mom	66.7 x 0.0001/26.9 x 0.00001 mom
	Grain Unit	1852 x 0.002 GN	3395 x 0.002 GN	4938 x 0.002 GN	3395 x 0.002/787 x 0.0002 GN	3858 x 0.002/1559 x 0.0002 GN
	Tola	10.29 x 0.00001 to	18.86 x 0.00001 to	27.44 x 0.00001 to	18.86 x 0.00001/4.37 x 0.000001 to	21.43 x 0.00001/8.66 x 0.000001 to
	Tael	3.20 x 0.00001 TL	5.87 x 0.00001 TL	8.53 x 0.00001 TL	5.87 x 0.00001/1.36 x 0.000001 TL	6.67 x 0.00001/2.69 x 0.000001 TL

<sup>^</sup> Weighing Chamber



### Part Number/Price

PART #	MODEL #	DESCRIPTION	PRICE
97597	GH-120	120 g x 0.0001 g	\$3,435.00
97599	GH-200	220 g x 0.0001 g	3,895.00
97600	GH-300	320 g x 0.0001 g	4,625.00
97601	GH-202	220/51 g x 0.0001/0.00001 g	5,195.00
97602	GH-252	250/101 g x 0.0001/0.00001 g	5,725.00

### Options/Accessories

PART #	MODEL #	DESCRIPTION	PRICE
97604	GH-08	Ethernet option for GH	\$664.00
97605	AD-100-2	Anti theft device	70.00
97606	AD-1653	Density determination kit	535.00
97607	AD-1682	Rechargeable battery pack, external	658.00
97608	AD-8920	Universal remote display	260.00
97609	AD-8922	Remote controller	615.00
97610	AD-1683	Static eliminator	1,219.00
151247	AD-1688	Data logger	295.00
97612	SW:128	Foot switch	72.00
97649	TB:248	AC adapter (120V/220V)	41.00

**Standard Features**

- GLP/GMP/GCP/ISO compliant software outputs the calibration data and ID number of the balance for calibration confirmation to the AD-8121B printer
- Easy access door system
- Automatic self-calibration
- Data memory function
- Underhook capability for density measurement and weighing magnetic material
- Internal calibration standard
- Liquid Crystal Display (LCD)
- RS-232 bidirectional interface
- WinCT® communication tools software

**Specifications**

	GR-120 <sup>^</sup>	GR-200 <sup>^</sup>	GR-300 <sup>^</sup>	GR-202 <sup>^</sup>	
<b>Part #</b>	<b>97625</b>	<b>97626</b>	<b>97627</b>	<b>97628</b>	
<b>List Price</b>	<b>\$2,925.00</b>	<b>\$3,395.00</b>	<b>\$4,195.00</b>	<b>\$4,785.00</b>	
Capacity	120 g	210 g	310 g	210/42 g	
<b>Resolution</b>	<b>0.0001 g</b>	<b>0.0001 g</b>	<b>0.0001 g</b>	<b>0.0001/ 0.00001 g</b>	
Operating Modes	Percentage, Counting				
Repeatability	0.0001 g	0.0001 g	0.0001 g	0.0001/0.00002 g	
Linearity	±0.0002 g	±0.0002 g	±0.0002 g	±0.0002/±0.00003 g	
Stabilization Time	Approx. 3.5 sec (0.1 mg)/8 sec (0.01 mg)				
Sensitivity Drift (10° C to 30° C)	±2ppm/° C 50° F to 86° F (10° C to 30° C)				
Operating Temperature	41° F to 104° F (5° C to 40° C) 85% RH or less (no condensation)				
<b>Pan Size</b>	<b>Ø 3.3 in (85 mm)</b>				
Physical Dimensions	9.8 W x 12.99 D x 12.87 in H (249 x 330 x 327 mm)				
Weighing Chamber	7.01 W x 6.5 D x 9.17 in H (178 x 160 x 233 mm)				
Weight	Approx. 13.2 lb (6.0 kg)				
Ext. Cal. Mass (optional)	50 g/100 g	100 g/200 g	200 g/300 g	100 g/200 g	
Power	120V AC (AC Adapter) 50Hz/60 Hz, 11 VA (110, 220, 240VAC adapter by special order)				
Warranty	Five-year limited warranty				
Return Policy	A&D Weighing Standard Policy - restock fee may apply				
UNIT OF MEASURE	Decimal Ounce	4.2 x 0.00001 oz	7.4 x 0.00001 oz	10 x 0.00001 oz	7.4 x 0.00001/1.4 x 0.000001 oz
	Troy Ounce	3.8 x 0.00001 ozt	6.7 x 0.00001 ozt	9.9 x 0.00001 ozt	6.7 x 0.00001/1.3 x 0.000001 ozt
	Pennyweight	77 x 0.0001 dwt	135 x 0.0001 dwt	199 x 0.0001 dwt	135 x 0.0001/27 x 0.00001 dwt
	Carat	600 x 0.001 ct	1050 x 0.001 ct	1550 x 0.001 ct	1050 x 0.001/210 x 0.0001 ct
	Momme	32 x 0.0001 mom	56 x 0.0001 mom	82 x 0.0001 mom	56 x 0.0001/11 x 0.00001 mom
	Grain Unit	1851 x 0.002 GN	3240 x 0.002 GN	4784 x 0.002 GN	3240 x 0.002/648 x 0.0002 GN
	Tola	10 x 0.00001 to	18 x 0.00001 to	26 x 0.00001 to	18 x 0.00001/3.6 x 0.000001 to
	Tael	3.1 x 0.00001 TL	5.5 x 0.00001 TL	8.2 x 0.00001 TL	5.5 x 0.00001/1.1 x 0.000001 TL

<sup>^</sup> Weighing Chamber

### Part Number/Price

PART #	MODEL #	DESCRIPTION	PRICE
97625	GR-120	120 g x 0.0001 g	\$2,925.00
97626	GR-200	210 g x 0.0001 g	3,395.00
97627	GR-300	310 g x 0.0001 g	4,195.00
97628	GR-202	210/42 g x 0.0001/0.00001 g	4,785.00

### Options/Accessories

PART #	A&D MODEL #	DESCRIPTION	PRICE
97605	AD-100-2	Anti-theft device	\$70.00
97606	AD-1653	Density determination kit	535.00
97607	AD-1682	Rechargeable battery pack	658.00
97608	AD-8920	Universal remote display	260.00
97609	AD-8922	Remote controller	615.00
97610	AD-1683	Static eliminator	1,219.00
97612	SW:128	Foot switch	72.00
97649	TB:248	AC adapter (120V/220V AC)	41.00
151247	AD-1688	Data logger	295.00
158785	AD-8121B	Impact Dot Matrix, statistical printer, includes cable	865.00

A & D Weighing  
**HR-AZ/A Series**

Capacity: 225g Readability: 0.00001g-0.0001g

Analytical Balance

**Standard Features**

- Fast stabilization time
- One touch calibration in HR-AZ models
- Compact footprint size
- Rotary sliding doors
- Removable Breeze break with anti-static coating.
- GLP/GMP/GCP/ISO compliant



**Specifications**

	HR-100A <sup>^</sup>	HR-100AZ <sup>^</sup>	HR-150A <sup>^</sup>	HR-150AZ <sup>^</sup>	HR-250A <sup>^</sup>	HR-250AZ <sup>^</sup>	
<b>Part#</b>	150777	150779	150780	150781	150782	150783	
<b>List Price</b>	\$1,756.00	\$2,173.00	\$1,863.00	\$2,279.00	\$2,025.00	\$2,482.00	
Capacity (g)	102		152		252		
<b>Resolution (g)</b>	0.0001						
Operating Modes	Weighing, Percent Weighing, Parts Counting, Density						
Repeatability	0.1 mg			<200 mg 0.1 mg/>200 mg 0.2 mg			
Linearity	+/- 0.2 mg			+/- 0.3 mg			
Stabilization Time	3 seconds						
Operating Temperature	41° F to 104° F (5° C to 40° C), 85% RH or less (no condensation)						
<b>Pan Size</b>	Ø 3.6 inches (90 mm)						
Physical Dimensions	7.8 x 11.6 x 12.3 in (198 x 294 x 313 mm)						
Weight	8.6 lb (3.9 kg)						
Calibration Weight (g)	200		150		100		
Power	120/240 AC adapter						
Warranty	Five-year limited warranty						
Return Policy	A&D Weighing Standard Policy - restock fee may apply						
<b>UNIT OF MEASURE</b>	Decimal Ounce	3.59 x 0.00001	3.59 x 0.00001	5.36 x 0.00001	5.36 x 0.00001	8.88 x 0.00001	8.88 x 0.00001
	Troy Ounce	3.27 x 0.00001	3.27 x 0.00001	4.88 x 0.00001	4.88 x 0.00001	8.10 x 0.00001	8.10 x 0.00001
	Pennyweight	65.5 x 0.0001	65.5 x 0.0001	97.7 x 0.0001	97.7 x 0.0001	162 x 0.0001	162 x 0.0001
	Carat	510 x 0.001	510 x 0.001	760 x 0.001	760 x 0.001	1260 x 0.001	1260 x 0.001
	Momme	27.2 x 0.0001	27.2 x 0.0001	40.5 x 0.0001	40.5 x 0.0001	67.2 x 0.0001	67.2 x 0.0001
	Grain Unit	1574 x 0.002	1574 x 0.002	2346 x 0.002	2346 x 0.002	3889 x 0.002	3889 x 0.002
	Tola	8.74 x 0.00001	8.74 x 0.00001	13.0 x 0.00001	13.0 x 0.00001	21.6 x 0.00001	21.6 x 0.00001
	Tael (T)	2.72 x 0.00001	2.72 x 0.00001	4.02 x 0.00001	4.02 x 0.00001	6.66 x 0.00001	6.66 x 0.0001

<sup>^</sup> Weighing Chamber

A & D Weighing  
**HR-AZ/A Series**  
 Analytical Balance

### Part Number/Price

PART #	MODEL #	DESCRIPTION	PRICE
150777	HR-100A	102 g x 0.0001 g	\$1,756.00
150779	HR-100AZ	102 g x 0.0001 g	2,173.00
150780	HR-150A	152 g x 0.0001 g	1,863.00
150781	HR-150AZ	152 g x 0.0001 g	2,279.00
150782	HR-250A	252 g x 0.0001 g	2,025.00
150783	HR-250AZ	252 g x 0.0001 g	2,482.00

### Options/Accessories

PART #	A&D MODEL #	DESCRIPTION	PRICE
151247	AD-1688	Data logger	\$295.00
98027*	FXi-02	Quick USB interface with cable	84.00
98028*	FXi-08	Ethernet interface with WIN-CT Plus	465.00
98029*	FXi-09	Rechargeable battery	310.00
97649	TB:248	AC adapter	41.00

\*Only one option may be installed

A & D Weighing  
**Orion HR Series**

Capacity: 60g-320g    Readability: 0.00001 g-0.0001 g

Analytical/Semi-Micro

**Standard Features**

- GLP/GMP/GCP/ISO compliant software outputs the calibration data and ID number of the balance for calibration confirmation to the AD-8121B printer
- Optional battery pack (HR-60, HR-120 and HR-200)
- System diagnostics to alert operator of abnormal weighing conditions
- RS-232C bidirectional interface (HR-60C, HR-120C and HR-200C. Standard for HR-300i and HR-202i)
- Underhook capability for density measurement and weighing magnetic materials
- Liquid Crystal Display (LCD)
- WinCT® communication tools software

Note: Orion HR series does have internal calibration



**Specifications**

	HR-60 <sup>^</sup>	HR-60C <sup>^</sup>	HR-120 <sup>^</sup>	HR-120C <sup>^</sup>	HR-200 <sup>^</sup>	HR-200/C <sup>^</sup>	HR-300I <sup>^</sup>	HR-202I <sup>^</sup>
<b>Part#</b>	-	-	97637	97638	97639	97640	97642	97641
<b>List Price</b>	-	-	\$2,350.00	\$2,435.00	\$2,500.00	\$2,600.00	\$4,065.00	\$4,510.00
<b>NTEP Part#</b>	97635	97636	-	-	-	-	-	-
<b>NTEP List Price</b>	\$1,895.00	\$1,995.00	-	-	-	-	-	-
<b>Capacity</b>	60 g		120 g		210 g		320 g	220/51 g
<b>Resolution</b>	0.0001 g (NTEP 0.001 g)		0.0001 g		0.0001 g		0.0001 g	0.0001/ 0.00001 g
<b>Operating Modes</b>	Percentage, Counting							
<b>Repeatability</b>	0.0001 g						±0.0003 mg	±0.0002/±0.00003 g
<b>Linearity</b>	±0.0002 g						0.0002 mg	0.0001/0.00002 g
<b>Stabilization Time</b>	3 seconds (typically)						Approx. 3.5 seconds	Approx. 3.5/8 seconds
<b>Sensitivity Drift (10° C-30° C)</b>	±2 ppm/° C (when automatic self calibration is not used)							
<b>Operating Temperature</b>	41° F to 104° F (5° C to 40° C) 85% RH or less (no condensation)							
<b>Pan Size</b>	Ø 3.3 in (85 mm)						Ø 3.6 in (90 mm)	
<b>Dimensions</b>	8.4 W x 12.8 D x 11.9 in H (213 x 319 x 301 mm)						8.54 W x 17.4 D x 12.24 in H (217 x 442 x 316 mm)	
<b>Weighing Chamber</b>	7.1 W x 7.5 D x 7.9 in H (180 x 192 x 200 mm)						6.45 W x 5.84 D x 9.88 in H (164 x 148.5 x 251 mm)	
<b>Weight</b>	Approx. 12.5 lb (5.7 kg)						Approx. 17.6 lb (8.0 kg)	
<b>Ext. Cal. Mass (optional)</b>	50 g		100 g		200 g		300 g/200 g/100 g	200 g/100 g/50 g/20 g
<b>Power</b>	120V AC (AC Adapter) 50 Hz/60 Hz (110, 220, 240V AC adapter available by special order)							
<b>Approvals</b>	NTEP CC 97-084							
<b>Warranty</b>	Five-year limited warranty							
<b>Return Policy</b>	A&D Weighing Standard Policy - restock fee may apply							
<b>UNIT OF MEASURE</b>								
Decimal Ounce	2.1 x 0.000005 oz		4.2 x 0.000005 oz		7.4 x 0.000005 oz		11.29 x 0.00001 oz	7.76 x 0.00001/1.8 x 0.000001 oz
Troy Ounce	1.9 x 0.000005 ozt		3.8 x 0.000005 ozt		6.7 x 0.000005 ozt		10.3 x 0.00001 ozt	7.07 x 0.00001/1.64 x 0.000001 ozt
Pennyweight	38 x 0.0001 dwt		77 x 0.0001 dwt		135 x 0.0001 dwt		199 x 0.0001 dwt	141.5 x 0.0001/32.8 x 0.00001 dwt
Carat	300 x 0.001 ct		600 x 0.001 ct		1050 x 0.001 ct		1550 x 0.001 ct	1100 x 0.001/255 x 0.0001 ct
Momme	16 x 0.00005 mom		32 x 0.00005 mom		56 x 0.00005 mom		82 x 0.0001 mom	58.7 x 0.0001/13.6 x 0.00001 mom
Grain Unit	925 x 0.002 GN		1851 x 0.002 GN		3240 x 0.002 GN		4784 x 0.002 GN	3395 x 0.002/787 x 0.0002 GN
Tola	5 x 0.00001 to		10 x 0.00001 to		18 x 0.00001 to		26 x 0.00001 to	18.8 x 0.00001/4.37 x 0.000001 to
Tael	1.5 x 0.000005 TL		3.1 x 0.000005 TL		5.5 x 0.000005 TL		8.2 x 0.00001 TL	5.87 x 0.00001/1.36 x 0.000001 TL

<sup>^</sup> Weighing Chamber

### Part Number/Price

PART #	MODEL #	DESCRIPTION	PRICE
97635	HR-60	60 g x 0.0001 g (NTEP 0.001 g)	\$1,895.00
97636	HR-60C	60 g x 0.0001 g (NTEP 0.001 g)	1,995.00
97637	HR-120	120 g x 0.0001 g	2,350.00
97638	HR-120C	120 g x 0.0001 g	2,435.00
97639	HR-200	210 g x 0.0001 g	2,500.00
97640	HR-200/C	210 g x 0.0001 g	2,600.00
97642	HR-300i	320 g x 0.0001 g	4,065.00
97641	HR-202i	220/51 g x 0.0001/0.00001 g	4,510.00

### Options/Accessories

PART #	A&D MODEL #	DESCRIPTION	PRICE
97646	HR-03	Serial interface (RS-232C) for HR-60/120/200	\$175.00
97647	HR-05	20mA current loop interface for HR-60/120/200	122.00
97648	HR-09	NiCad battery pack for HR-60, HR-60-C, HR-120, HR-120-C, HR-200, HR-200-C only	465.00
97605	AD-100-2	Anti-theft device	70.00
97606	AD-1653	Density determination kit	535.00
97607	AD-1682	Rechargeable battery pack, external	658.00
97608	AD-8920	Universal remote display	260.00
97610	AD-1683	Static eliminator	1,219.00
97609	AD-8922	Remote controller	615.00
97649	TB:248	HR AC adapter (120V/220V)	41.00
151247	AD-1688	Data logger	295.00
158785	AD-8121B	Impact dot matrix statistical printer, includes cable	865.00

A & D Weighing  
**AD-4212A Series**

Capacity: 110g-1100g    Readability: 0.00001g-0.001g

Analytical Balances

**Standard Features**

- Comparator output (Hi/OK/Lo) feature for manual or automatic operation as well as buzzer function
- GLP/GMP compliant software output
- Breeze break for maximum accuracy and fastest response
- Standard calibration weight
- Simple operator reference card provided
- Multi-weighing units
- Time and date clock function
- Data memory function for weighing, calibration, counting and Hi/OK/Lo values
- Counting and percent mode
- Super Hybrid Sensor Technology (SHS)
- WinCT® communication tools software
- RS-232C bidirectional interface



**Specifications**

	AD-4212A-100	AD-4212B-102	AD-4212A-200	AD-4212B-201
<b>Part#</b>	<b>97654</b>	<b>102925</b>	<b>97655</b>	<b>102926</b>
<b>List Price</b>	<b>\$5,495.00</b>	<b>\$8,495.00</b>	<b>\$4,825.00</b>	<b>\$6,695.00</b>
Capacity	110 g	110 g	210 g	210 g
<b>Resolution</b>	<b>0.0001 g</b>	<b>0.00001 g</b>	<b>0.001 g</b>	<b>0.0001 g</b>
Operating Modes	Counting, Percentage			
Repeatability (Std. Dev.)	0.00015 g	0.00015 g	0.001 g	
Linearity	±0.0003 g	±0.0003 g	±0.002 g	±0.002 g
Stabilization Time (typical)	0-30 g Approx. 1.1 sec	0-30 g Approx. 1.1 sec	0-30 g Approx. 0.8 sec	0-30 g Approx. 0.8 sec
	30-110 g Approx. 1.3 sec	30-110 g Approx. 1.3 sec	30-210 g Approx. 1.0 sec	30-210 g Approx. 1.0 sec
Sensitivity Drift	±2 ppm / °C 10°C to 30°C (50°F to 86°F)			
Operating Temperature	41°F to 104°F (5°C to 40°C) 85% RH or less (no condensation)			
I/O Interface	RS-232C	Bidirectional 600-19,200		
	Comparator Output	3 level output with buzzer		
	External Contact Input	Re-zero and print		
Weighing Unit	Dimensions	3.2 x 9.1 x 3.5 in (80 W x 230 D x 90 H mm)		
	<b>Weighing Pan</b>	<b>2 x 2 in (50 x 50 mm)</b>		
	Weight	Approx. 2 kg		
Display Unit	Dimensions	9.3 W x 6.0 D x 6.1 in H (237 W x 150 D x 155 mm H)		
	Weight	Approx. 2 kg		
	Connection Cable	Approx. 2 m (between weighing unit and display unit)		
Shipping Weight	8.5 lb (4 kg)			
Calibration Weight (OIML F1 (OPT))	50 g	50 g	100 g	100 g
Power Supply	120V AC Adapter, 11 VA			
Warranty	Five-year limited warranty			
Return Policy	A&D Weighing Standard Policy - restock fee may apply			
Milligram	110000.0 x 0.1 mg	110000.0 x 0.01 mg	210000 x 1 mg	210000 x 0.1 mg
Ounce	3.880135 x 0.000005 oz	3.880135 x 0.000005 oz	7.40755 x 0.00005 oz	7.40755 x 0.00005 oz
Troy Ounce	3.536580 x 0.000005 ozt	3.536580 x 0.000005 ozt	6.75165 x 0.00005 ozt	6.75165 x 0.00005 ozt
Carat	550.0 x 0.0005 ct	550.0 x 0.0005 ct	1050.0 x 0.005 ct	1050.0 x 0.005 ct
Momme	29.33335 x 0.00005 mom	29.33335 x 0.00005 mom	56.0 x 0.0005 mom	56.0 x 0.0005 mom
Pennyweight	70.7316 x 0.0001 dwt	70.7316 x 0.0001 dwt	135.033 x 0.001 dwt	135.033 x 0.001 dwt
Grain	1697.56 x 0.002 GN	1697.56 x 0.002 GN	3240.80 x 0.02 GN	3240.80 x 0.02 GN
Tael (HK Gen, Singapore)	2.910100 x 0.000005	2.910100 x 0.000005	5.55565 x 0.00005	5.55565 x 0.00005
Tael (HK jewelry)	2.938900 x 0.000005	2.938900 x 0.000005	5.61060 x 0.00005	5.61060 x 0.00005
Tael (Taiwan)	2.933335 x 0.000005	2.933335 x 0.000005	5.600 x 0.00005	5.600 x 0.00005
Tael (China)	3.520 x 0.00005	3.520 x 0.00005	6.7200 x 0.00005	6.7200 x 0.00005
Tola (India)	9.43089 x 0.00001	9.43089 x 0.00001	18.0044 x 0.0001	18.0044 x 0.0001
Messaghal	23.46665 x 0.00005	23.46665 x 0.00005	44.80 x 0.0005	44.80 x 0.0005



## Specifications

	AD-4212B-301		AD-4212A-600		AD-4212A-1000	
<b>Part #</b>	<b>102927</b>		<b>97656</b>		<b>97657</b>	
List Price	<b>\$7,225.00</b>		<b>\$5,325.00</b>		<b>\$5,525.00</b>	
<b>Capacity</b>	310 g		610 g		1100 g	
Resolution	<b>0.0001 g</b>		<b>0.001 g</b>			
Operating Modes	Counting, Percentage					
Repeatability (Std. Dev.)	0.001 g					
Linearity	±0.002 g		±0.0003 g			
Stabilization Time (typical)	0-30 g	Approx. 0.8 seconds	0-30 g	Approx. 0.9 seconds	0-30 g	Approx. 0.9 sec
	30- 210 g	Approx. 1.0 second	30-610 g	Approx. 1.1 seconds	30-1100 g	Approx. 1.1 sec
Sensitivity Drift	±2 ppm/°C 50°F to 86°F (10°C to 30°C)					
Operating Temperature	41°F to 104°F (5°C to 40°C) 85% RH or less (no condensation)					
I/O Interface	RS-232C		Bidirectional 600-19,200			
	Comparator Output		3 level output with buzzer			
	External Contact Input		Re-zero and print			
Weighing Unit	Dimensions 3.2 W x 9.1 D x 3.5 in H (80 x 230 x 90 mm)					
	<b>Weighing Pan</b>	<b>2 x 2 in (50 x 50 mm)</b>	<b>2.8 x 2.8 in(70 x 70 mm)</b>			
Display Unit	Weight Approx. 2 kg					
	Dimensions 237 W x 150 D x 155 mm H					
	Weight Approx. 2 kg					
Connection Cable		Approx. 2 m (between weighing unit and display unit)				
Shipping Weight		8.5 lb (4 kg)				
Calibration Weight (OIML F1)(OPT)		100 g	200 g			
Power Supply		120V AC Adapter, 11 VA				
Warranty		Five-year limited warranty				
Return Policy		A&D Weighing Standard Policy - restock fee may apply				
UNIT OF MEASURE	Milligram	2100000 x 1 mg	660000 x 0.00005 mg	1210000 x 0.00005 mg		
	Ounce	7.40755 x 0.00005 oz	23.28081 x 0.00005 oz	42.681485 x 0.00005 oz		
	Troy Ounce	6.75165 x 0.00005 ozt	21.21948 x 0.00005 ozt	38.90238 x 0.00005 ozt		
	Carat	1050.0 x 0.005 ct	3300 x 0.005 ct	6050 x 0.005 ct		
	Momme	56.0 x 0.0005 mom	176.0001 x 0.0005 mom	322.66685 x 0.0005 mom		
	Pennyweight	135.033 x 0.001 dwt	424.3896 x 0.001 dwt	778.0476 x 0.001 dwt		
	Grain	3240.80 x 0.02 GN	10185.36 x 0.02 GN	18673.16 x 0.02 GN		
	Tael (HK Gen, Singapore)	5.55565 x 0.00005	17.4606 x 0.00005	32.0111 x 0.00005		
	Tael (HK jewelry)	5.61060 x 0.00005	17.6334 x 0.00005	32.3279 x 0.00005		
	Tael (Taiwan)	5.600 x 0.00005	17.60001 x 0.00005	32.266685 x 0.00005		
	Tael (China)	6.7200 x 0.00005	21.12 x 0.00005	38.72 x 0.00005		
	Tola (India)	18.0044 x 0.0001	56.58534 x 0.0001	103.73979 x 0.0001		
	Messaghal	44.80 x 0.0005	140.7999 x 0.0005	258.13315 x 0.0005		

A & D Weighing

## AD-4212A Series

Analytical Balances

BALANCES

### Part Number/Price

PART #	A&D MODEL #	DESCRIPTION	PRICE
97654	AD-4212A-100	110 g x 0.0001 g	\$5,495.00
102925	AD-4212B-102	110 g x 0.00001 g	8,495.00
97655	AD-4212A-200	210 g x 0.001 g	4,825.00
102926	AD-4212B-201	210 g x 0.0001 g	6,695.00
102927	AD-4212B-301	210 g x 0.0001 g	7,225.00
97656	AD-4212A-600	610 g x 0.001 g	5,325.00
97657	AD-4212A-1000	1100 g x 0.001 g	5,525.00

### Options/Accessories

PART #	A&D MODEL #	DESCRIPTION	PRICE
97672	AD-4212A-01	BCD output (factory installed, four month lead time)	\$560.00
97674	AD-4212A-07	Extension cable, 3 m	159.00
97675	AD-4212A-08	Ethernet Interface with WinCT	765.00
97676	AD-4212A-19	Stainless steel breeze break (200 g only)	102.00

www.ricelake.com | Phone: 800-472-6703

RICE LAKE

## Standard Features

- Internal calibration weight
- Auto environmental compensation
- IP54 splash-proof operator keyboard
- RS-232C bidirectional interface
- WinCT® communication tools software
- GLP/GMP/ISO compliant to either AD-8121 printer or computer.
- Transmits date, time, ID number, serial number and calibration data
- Auto re-zero function
- Interval time setting; built-in time and date
- Rechargeable battery option for portable needs
- Data memory function
- Multiple weighing modes: Counting, Percentage and Comparator Modes
- Super Hybrid Sensor Technology (SHS)
- Vacuum Fluorescent Display (VFD)
- Optional glass breeze break
- Underhook weighing



## Specifications

	GX-200 <sup>^</sup>	GX-400 <sup>^</sup>	GX-600 <sup>^</sup>	GX-800 <sup>^</sup>	GX-1000 <sup>^</sup>
<b>Part#</b>	97685	97686	97687	97688	97689
<b>List Price</b>	<b>\$1,893.00</b>	<b>\$2,360.00</b>	<b>\$2,795.00</b>	<b>\$2,960.00</b>	<b>\$3,145.00</b>
Capacity	210 g	410 g	610 g	810 g	1100 g
<b>Resolution</b>	<b>0.001 g</b>	<b>0.001 g</b>	<b>0.001 g</b>	<b>0.001 g</b>	<b>0.001 g</b>
Modes	Animal weighing, comparator function, ACAL counting function, percentage function, density determination				
Repeatability	0.001 g				
Linearity	±0.002 g		±0.003 g		
Stabilization Time	Approx 1 second (typical in FAST mode)			Approx. 1.5 seconds	
Display Refresh	5 times per second (stable) / 10 times per second (unstable)				
Operating temperature	41° F to 104° F (5° C to 40° C) RH less than 85% (No condensation)				
<b>Pan Size</b>	<b>5.04 x 5.04 in (128 x 128 mm)</b>				
Physical Dimension	8.26 W x 12.48 D x 3.38 in H (210 x 317 x 86 mm)				
Weighing Chamber	3.6 in H (91.3 mm H)				
Weight (Approx.)	2.15 lb (4.6 kg)				
Power	120/240 VAC adapter Approx 11 VA				
Warranty	Five-year limited warranty				
Return Policy	A&D Weighing Standard Policy - restock fee may apply				
Decimal Ounce	7.40755 x 0.00005 oz	14.46230 x 0.00005 oz	21.51710 x 0.00005 oz	28.57190 x 0.00005 oz	38.80135 x 0.00005 oz
Decimal Pound	0.462970 x 0.000005 lb	0.903895 x 0.000005 lb	1.344820 x 0.000005 lb	1.785744 x 0.000005 lb	2.425084 x 0.000005 lb
Troy Ounce	6.75165 x 0.00005 ozt	13.18180 x 0.00005 ozt	19.61195 x 0.00005 ozt	26.04210 x 0.00005 ozt	35.36582 x 0.00005 ozt
Pennyweight	135.033 x 0.001 dwt	263.636 x 0.001 dwt	392.239 x 0.001 dwt	520.842 x 0.001 dwt	707.316 x 0.001 dwt
Carat	1050.000 x 0.00 5 ct	2050.000 x 0.005 ct	3050.000 x 0.005 ct	4050.000 x 0.005 ct	5500.000 x 0.005 ct
Momme	56.0000 x 0.0005 mom	109.3335 x 0.0005 mom	162.6665 x 0.0005 mom	215 x 0.0005 mom	270 x 0.0005 mom
Grain Unit	3240.80 x 0.02 GN	6327.26 x 0.02 GN	9413.74 x 0.02 GN	12500.21 x 0.02 GN	16975.6 x 0.02 GN
Pound x Ounce 4 lb 10.08 oz	7.4 1 oz	14.46 oz	1 lb 5.52 oz	1 lb 12.80 oz	2 lb 4 oz

<sup>^</sup> Weighing Chamber

UNIT OF MEASURE

## Specifications

	GX-2000	GX-4000	GX-6100	GX-6000	GX-8000	
<b>Part#</b>	<b>97690</b>	<b>97691</b>	<b>97692</b>	<b>97693</b>	<b>97694</b>	
<b>List Price</b>	<b>\$1,895.00</b>	<b>\$2,540.00</b>	<b>\$2,840.00</b>	<b>\$2,185.00</b>	<b>\$2,385.00</b>	
Capacity	2100 g	4100 g	6100 g	6100 g	8100 g	
<b>Resolution</b>	<b>0.01 g</b>	<b>0.01 g</b>	<b>0.01 g</b>	<b>0.1 g</b>	<b>0.1 g</b>	
Modes	Animal weighing, comparator function, ACAI counting function, percentage function, density determination					
Repeatability	0.01 g			0.1 g		
Linearity	±0.02 g		±0.03 g	±0.1 g		
Stabilization Time	Approx. 1 sec (typical in FAST mode)		Approx. 1.5 seconds	Approx. 1 second		
Display Refresh	5 times per second (stable) / 10 times per second (unstable)					
Operating temperature	41°F to 104°F (5°C to 40°C) RH less than 85% (No condensation)					
<b>Pan Size</b>	<b>6.50 in x 6.50 in (165 x 165 mm)</b>					
Physical Dimension	8.26 W x 12.48 D x 3.38 H in (210 x 317 x 86 mm)					
Weighing Chamber	3.6 in H (91.4 mm H)					
Weight (Approx.)	Approx 2.05 lb (5.1 kg)					
Power	120/240V by AC adapter Approx 11 VA					
Warranty	Five-year limited warranty					
Return Policy	A&D Weighing Standard Policy - restock fee may apply					
UNIT OF MEASURE	Decimal Ounce	74.0755 x 0.0005 oz	144.6230 x 0.0005 oz	215.1710 x 0.0005 oz	215.170 x 0.005 oz	285.720 x 0.005 oz
	Decimal Pound	4.62970 x 0.00005 lb	9.03895 x 0.00005 lb	13.44820 x 0.00005 lb	13.4480 x 0.0005 lb	17.8575 x 0.0005 lb
	Troy Ounce	67.5165 x 0.0005 ozt	131.8180 x 0.0005 ozt	196.1195 x 0.0005 ozt	196.120 x 0.005 ozt	260.420 x 0.0005 ozt
	Pennyweight	1350.33 x 0.01 dwt	2636.36 x 0.01 dwt	3922.39 x 0.01 dwt	3922.4 x 0.1 dwt	5208.4 x 0.1 dwt
	Carat	10500.00 x 0.05 ct	20500.00 x 0.05 ct	30500.00 x 0.05 ct	30500.0 x 0.5 ct	40500.0 x 0.5 ct
	Momme	560.000 x 0.005 mom	1093.335 x 0.005 mom	1626.665 x 0.005 mom	1626.65 x 0.05 mom	2160.00 x 0.05 mom
	Grain Unit	32408.0 x 0.2 GN	63272.6 x 0.2 GN	94137.4 x 0.2 GN	94136 x 2 GN	125002 x 2 GN
	Pound x Ounce 4 lb 10.08 oz	9 lb 0.62 oz	13 lb 7.17 oz	13 lb 7.17 oz	17 lb 13.72 oz	

### Part Number/Price

PART #	MODEL #	DESCRIPTION	PRICE
97685	GX-200	210 g x 0.001 g	\$1,893.00
97686	GX-400	410 g x 0.001 g	2,360.00
97687	GX-600	610 g x 0.001 g	2,795.00
97688	GX-800	810 g x 0.001 g	2,960.00
97689	GX-1000	1100 g x 0.001 g	3,145.00
97690	GX-2000	2100 g x 0.01 g	1,895.00
97691	GX-4000	4100 g x 0.01 g	2,540.00
97692	GX-6100	6100 g x 0.01 g	2,840.00
97693	GX-6000	6100 g x 0.1 g	2,185.00
97694	GX-8000	8100 g x 0.1 g	2,385.00

### Options/Accessories

PART #	A&D MODEL #	DESCRIPTION	PRICE
97695	GX-04	Comparator output; factory installed only	\$255.00
97696	GX-06	Analog output; factory installed only	815.00
97697	GX-10	Glass breeze break for GX-200/400/600/800/1000	265.00
97698	GX-11	Glass breeze break for GX-2000/4000/6000/6100/8000	292.00
97699	GX-12	Animal weighing pan for GX-400/600/2000/4000/6100/6000/8000	180.00
97700	GX-13	Density determination kit for GX-200/400/600	623.00
97607	AD-1682	Rechargeable battery pack (external)	658.00
97608	AD-8920	Universal remote display	260.00
97605	AD-100-2	Anti-theft device	70.00
97612	SW:128	Foot switch	72.00
97703	AX:073003691-S	Protective in-use cover for GX-200/400/600	18.00
97704	AX:073003692-S	Protective in-use cover for GX-2000/4000/6100/6000/8000	18.00
97649	TB:248	AC adapter (120V/220V)	41.00
102891	GX-02	USB option	144.00
151247	AD-1688	Data logger	295.00
158785	AD-8121B	Impact dot matrix statistical printer, cable included	865.00

**Standard Features**

- IP54 splash proof operator keyboard
- RS-232C bidirectional communication
- GLP/ISO/LIMS compliant to either AD-8121 printer or computer. Transmits date, time, ID number, serial number and calibration data
- Auto re-zero function
- Data collection software compatible
- WinCT® communication tools software
- Interval time setting
- Data memory function
- Multiple weighing units
- Rechargeable battery option for portable needs
- Vacuum fluorescent display (VFD)
- Optional glass breeze break
- Underhook weighing
- Super Hybrid Sensor Technology (SHS)
- External calibration



**Specifications**

	GF-200 <sup>^</sup>	GF-300 <sup>^</sup>	GF-400 <sup>^</sup>	GF-600 <sup>^</sup>	GF-800 <sup>^</sup>	GF-1000 <sup>^</sup>	GF-1200
<b>Part #</b>	97707	97709	97711	97712	97713	97714	97715
<b>List Price</b>	\$1,345.00	\$1,510.00	\$1,785.00	\$2,400.00	\$2,640.00	\$2,750.00	\$1,300.00
<b>NTEP Part # Class II</b>	97708	97710	-	-	-	-	97716
<b>NTEP List Price</b>	\$1,395.00	\$1,550.00	-	-	-	-	\$1,455.00
Capacity	210 g	310 g	410 g	610 g	810 g	1100 g	1210 g
Resolution	0.001 g (NTEP 0.01 g)	0.001 g (NTEP 0.01 g)	0.001 g	0.001 g	0.001 g	0.001 g	0.01 g (NTEP 0.1 g)
Operating Modes	Animal weighing, comparator function, ACAI counting function, percentage function, density determination						
Repeatability	0.001 g						0.01 g
Linearity	±0.002 g		±0.003 g				±0.02 g
Stabilization Time	Approx 1 second (typical in FAST mode)				Approx. 1.5 seconds		Approx. 1 sec (typical in FAST mode)
Operating Temperature	41° F to 104° F (5° C to 40° C)						
Weighing Chamber	3.6 in H (91.4 mm H)						
Pan Size	5.04 x 5.04 in (128 x 128 mm)						165 x 165 mm (6.5 x 6.5 in)
Dimensions	8.27 x 12.48 x 3.39 in (2100 x 317 x 86 mm)						
Weight (Approx.)	2.15 lb (4.6 kg)						Approx 2.05 lb (5.1 kg)
Est. Ship Weight	11.2 lb (5.2 kg)						
Power	120/240 VAC adapter, Approx. 11 VA						
Approvals	NTEP CC 03-005	-	-	-	-	-	NTEP CC 03-005
Warranty	Five-year limited warranty						
Return Policy	A&D Weighing Standard Policy - restock fee may apply						
Decimal Ounce	7.40755 x 0.00005 oz	10.93493 x 0.00005 oz	14.46230 x 0.00005 oz	21.51710 x 0.00005 oz	28.57190 x 0.00005 oz	38.80135 x 0.00005 oz	42.68149 x 0.0005 oz
Decimal Pound	0.462970 x 0.000005 lb	0.68343 x 0.000005 lb	0.903895 x 0.000005 lb	1.344820 x 0.000005 lb	1.785744 x 0.000005 lb	2.425084 x 0.000005 lb	2.66759 x 0.00005 lb
Troy Ounce	6.75165 x 0.00005 ozt	9.96673 x 0.00005 ozt	13.18180 x 0.00005 ozt	19.61195 x 0.00005 ozt	26.04210 x 0.00005 ozt	35.36582 x 0.00005 ozt	38.90240 x 0.0005 ozt
Pennyweight	135.033 x 0.001 dwt	199.33463 x 0.001 dwt	263.636 x 0.001 dwt	392.239 x 0.001 dwt	520.842 x 0.001 dwt	707.316 x 0.001 dwt	778.04807 x 0.01 dwt
Carat	1050.000 x 0.005 ct	1550.000 x 0.005 ct	2050.000 x 0.005 ct	3050.000 x 0.005 ct	4050.000 x 0.005 ct	5500.000 x 0.005 ct	6050 x 0.05 ct
Momme	56.0000 x 0.0005 mom	81.3332 x 0.0005 mom	109.3335 x 0.0005 mom	162.6665 x 0.0005 mom	215 x 0.0005 mom	270 x 0.0005 mom	270.000 x 0.005 mom
Grain Unit	3240.80 x 0.02 GN	4784.03 x 0.02 GN	6327.26 x 0.02 GN	9413.74 x 0.02 GN	12500.21 x 0.02 GN	16975.6 x 0.02 GN	18673.15 x 0.2 GN
Pound x Ounce (x 0.01oz)	7.41 oz	10.93 oz	14.46 oz	5.52 oz	1 lb 12.8 oz	2 lb 4 oz	2 lb, 11 oz

## Specifications

	GF-2000	GF-3000	GF-4000	GF-6100	GF-6000	GF-8000	
<b>Part#</b>	97717	97719	97721	97722	97723	97725	
<b>List Price</b>	\$1,350.00	\$1,515.00	\$1,925.00	\$2,435.00	\$1,795.00	\$2,105.00	
<b>NTEP Part# Class II</b>	97718	97720	-		97724	-	
<b>NTEP List Price</b>	\$1,495.00	\$1,625.00	-		\$1,895.00	-	
Capacity	2100 g	3100 g	4100 g	6100 g	6100 g	8100 g	
<b>Resolution</b>	<b>0.01 g</b> (NTEP 0.1 g)	<b>0.01 g</b> (NTEP 0.1 g)	<b>0.01 g</b>	<b>0.01 g</b> (NTEP 0.1 g)	<b>0.1 g</b>	<b>0.1 g</b>	
Operating Modes	Animal weighing, comparator function, ACAI counting function, percentage function, density determination						
Repeatability	0.01 g				0.1 g		
Linearity	±0.02 g			±0.03 g		±0.1 g	
Stabilization Time	Approx. 1 sec (typical in FAST mode)		Approx. 1.5 seconds		Approx. 1 second		
Operating Temperature	41° F to 104° F (5° C to 40° C)						
<b>Pan Size</b>	<b>6.5 x 6.5 in (165 x 165 mm)</b>						
Dimensions	8.27 x 12.48 x 3.39 in (2100 x 317 x 86 mm)						
Weight (Approx.)	Approx 2.05 lb (5.1 kg)						
Est. Ship Weight	11.2 lb (5.2 kg)						
Power	120/240 VAC adapter, Approx. 11 VA						
Approvals	NTEP CC 03-005		-	NTEP CC 03-005		-	
Warranty	Five-year limited warranty						
Return Policy	A&D Weighing Standard Policy - restock fee may apply						
<b>UNIT OF MEASURE</b>	Decimal Ounce	74.0755 x 0.0005 oz	109.34928 x 0.0005 oz	144.6230 x 0.0005 oz	215.1710 x 0.0005 oz	215.170 x 0.0005 oz	285.720 x 0.0005 oz
	Decimal Pound	4.62970 x 0.00005 lb	6.83433 x 0.00005 lb	9.03895 x 0.00005 lb	13.44820 x 0.00005 lb	13.4480 x 0.00005 lb	17.8575 x 0.00005 lb
	Troy Ounce	67.5165 x 0.0005 ozt	99.66731 x 0.0005 ozt	131.8180 x 0.0005 ozt	196.1195 x 0.0005 ozt	196.120 x 0.0005 ozt	260.420 x 0.0005 ozt
	Pennyweight	1350.33 x 0.01 dwt	1993.35 x 0.01 dwt	2636.36 x 0.01 dwt	3922.39 x 0.01 dwt	3922.4 x 0.1 dwt	5208.4 x 0.1 dwt
	Carat	10500.00 x 0.05 ct	15500.00 x 0.05 ct	20500.00 x 0.05 ct	30500.00 x 0.05 ct	30500.0 x 0.5 ct	40500.0 x 0.5 ct
	Momme	560.000 x 0.005 mom	813.325 x 0.005 mom	1093.335 x 0.005 mom	1626.665 x 0.005 mom	1626.65 x 0.05 mom	2160.00 x 0.05 mom
	Grain Unit	32408.0 x 0.2 GN	47840.31 GN	63272.6 x 0.2 GN	94137.4 x 0.2 GN	94136 x 2 GN	125002 x 2 GN
	Pound x Ounce (x 0.01oz)	4 lb 10.08 oz	7 lb 1 oz	9 lb 0.62 oz	13 lb 7.17 oz	13 lb 7.17 oz	17 lb 13.72 oz

^ Weighing Chamber

### Part Number/Price

PART #	MODEL #	DESCRIPTION	PRICE
97707	GF-200	210g x 0.001 g	\$1,345.00
97708	GF-200 (Class II)	210g x 0.001 g (NTEP 310g x 0.01 g)	1,395.00
97709	GF-300	310g x 0.001 g	1,510.00
97710	GF-300 (Class II)	310g x 0.001 g (NTEP 310g x 0.01 g)	1,550.00
97711	GF-400	410g x 0.001 g	1,785.00
97712	GF-600	610g x 0.001 g	2,405.00
97713	GF-800	810g x 0.001 g	2,640.00
97714	GF-1000	1100g x 0.001 g	2,750.00
97715	GF-1200	1210g x 0.01 g	1,300.00
97716	GF-1200 (Class II)	1210g x 0.01 g (NTEP 1210g x 0.1 g)	1,455.00
97717	GF-2000	2100g x 0.01 g	1,350.00
97718	GF-2000 (Class II)	2100g x 0.01 g (NTEP 2100g x 0.1 g)	1,495.00
97719	GF-3000	3100g x 0.01 g	1,515.00
97720	GF-3000 (Class II)	3100g x 0.01 g (NTEP 3100g x 0.1 g)	1,625.00
97721	GF-4000	4100g x 0.01 g	1,925.00
97722	GF-6100	6100g x 0.01 g	2,435.00
97723	GF-6000	6100g x 0.1 g	1,795.00
97724	GF-6000N (Class II)	6100g x 0.1 g (NTEP 6100g x 0.1 g)	1,895.00
97725	GF-8000	8100g x 0.1 g	2,105.00

### Options/Accessories

PART #	A&D MODEL #	DESCRIPTION	PRICE
97695	GX-04	Comparator output	\$255.00
97696	GX-06	Analog output; factory installed only	815.00
97697	GX-10	Glass breeze break for GF-200/300/400/600	265.00
97698	GX-11	Glass breeze break for GF-1200/2000/3000/6000	292.00
97699	GX-12	Animal weighing pan for GF-1200/2000/3000/6000	180.00
97700	GX-13	Density determination kit for GF-200/300	623.00
97607	AD-1682	Rechargeable battery pack, external	658.00
97608	AD-8920	Universal remote display	260.00
97605	AD-100-2	Anti-theft device	70.00
97612	SW:128	Foot switch	72.00
97703	AX:073003691-S	Protective in-use cover for GF-200/300/400/600	18.00
97704	AX:073003692-S	Protective in-use cover for GF-1200/2000/3000/4000/6100/6000/8000	18.00
97649	TB:248	AC adapter (120V/220V)	41.00
102891	GX-02	USB option	144.00
151247	AD-1688	Data logger	295.00
158785	AD-8121B	Dot matrix statistical printer, includes cable	865.00



## Standard Features

- Pill-counting feature also complies with Handbook 44 requirements
- Fast, Super Hybrid Sensor (SHS) gives you the ultimate in response speed; just one second
- Nine weighing modes
- GLP/GMP/ISO compliance
- WinCT® communication tools software included free
- Tough die-cast aluminum housing
- Removable stainless steel pan 5 in x 5 in (127 mm x 127 mm)
- NTEP and Pharmacopoeia approved
- IP54 splash proof operator keyboard protects against dust and spills, stainless steel weigh pan
- Data memory function
- Vacuum Fluorescent Display (VFD)
- RS-232



## Specifications

	GF-200P <sup>^</sup>	GF-300P <sup>^</sup>
<b>NTEP</b>		
<b>Part #</b>	97799	97800
<b>List Price</b>	\$1,345.00	\$1,495.00
Capacity	210 g	310 g
<b>Resolution</b>	<b>0.001 g</b>	<b>0.001 g</b>
Decimal Ounce	7.40755 x 0.00005 oz	10.93493 x 0.00005 oz
Repeatability	0.001 g	
Linearity	±0.002 g	
Stabilization Time	Approx 1 second (typical in FAST mode)	
Operating Temperature	41° F to 104° F (5° C to 40° C)	
Weighing Chamber	3.6 in H (91.4 mm)	
<b>Pan Size</b>	<b>5 x 5 in (127 mm)</b>	
Dimensions	8.27 x 12.48 x 3.39 in (210 x 317 x 86 mm)	
Weight (Approx.)	2.15 lb (4.6 kg)	
Est. Ship Weight	11 lb (5.2 kg)	
Power	110/220V VAC adapter	
Approvals	NTEP CC 04-077	
Warranty	Five-year limited warranty	
Return Policy	A&D Weighing Standard Policy - restock fee may apply	

<sup>^</sup> Weighing Chamber

## Part Number/ Price

PART #	MODEL #	DESCRIPTION (CAPACITY X RESOLUTION)	PRICE
97799	GF-200P	210 g x 0.001 g	\$1,345.00
97800	GF-300P	310 g x 0.001 g	1,495.00

## Options/Accessories

PART #	A&D MODEL #	DESCRIPTION	PRICE
97697	GX-10	Glass breeze break for GF-200 and 300	\$265.00
97703	AX:073003691-S	Protective in-use cover for GF-200/300 (each)	18.00
97649	TB:248	AC adapter (120V/220V) standard with unit	41.00
102891	GX-02	USB option	144.00

**Standard Features**

- Compact Super Hybrid Sensor Technology (SHS)
- Vacuum Fluorescent Display (VFD)
- GLP/GMP/ISO compliant to either AD-8121 printer or computer.  
Transmits date, time, ID number, serial number and calibration data
- Quick USB interface (FXi-02) Option
- RS-232C bidirectional communication
- Functions: data memory, comparator, buzzer, animal weigh and statistics
- Optional built-in rechargeable battery
- Multiple units of measurement
- Response indicator function
- LAN-Ethernet interface
- WinCT® communication tools software
- Underhook weighing

Note: FXi NTEP and FXi models available by special order (internal calibration)

**Specifications**

	FX-120i <sup>^</sup>	FX-200i <sup>^</sup>	FX-300i <sup>^</sup>	FX-1200i	FX-2000i	FX-3000i	
<b>Part#</b>	<b>98021</b>	<b>98022</b>	<b>98023</b>	<b>98024</b>	<b>98025</b>	<b>98026</b>	
<b>List Price</b>	<b>\$980.00</b>	<b>\$1,030.00</b>	<b>\$1,060.00</b>	<b>\$980.00</b>	<b>\$1,030.00</b>	<b>\$1,060.00</b>	
<b>NTEP</b>	—	—	—	<b>163641</b>	—	—	
	—	—	—	<b>\$1,035.00</b>	—	—	
Capacity	122 g	220 g	320 g	1220 g	2200 g	3200 g	
<b>Resolution</b>	<b>0.001 g</b>	<b>0.001 g</b>	<b>0.001 g</b>	<b>0.01 g</b>	<b>0.01 g</b>	<b>0.01 g</b>	
Repeatability		0.001 g			0.01 g		
Linearity		±0.002 g			±0.02 g		
Stabilization Time	Approx. 1 second						
Sensitivity Drift	±2 ppm/° C						
Display Refresh Rate	5 times / second, 10 times / second or 20 times / second						
Operating Temperature	41° F to 104° F (5° C to 40° C) 85% RH or less (No condensation)						
<b>Pan Size</b>	<b>130 mm (5.12 in)</b>			<b>150 mm (5.90 in)</b>			
Dimensions	7.6 W x 10.3 D x 3.3 in H (193 x 262.5 x 84.5 mm)						
Weight	Approx. 2.5 kg						
Est Ship Weight	8 lb (3.5 kg)						
External Calibration (weight optional)	100 g	200 g	300 g	1000 g	2000 g	3000 g	
Power Consumption	120/240V AC adapter, approx. 11 VA						
Approvals				NTEP 08-45A2			
Warranty	Five-year limited warranty						
Return Policy	A&D Weighing Standard Policy - restock fee may apply						
<b>UNIT OF MEASURE</b>	Decimal Ounce	4.30 x 0.00005 oz	7.76 x 0.00005 oz	11.28 x 0.00005 oz	43.0 x 0.0005 oz	112.8 x 0.0005 oz	
	Pound	0.268 x 0.000005 lb	0.485 x 0.000005 lb	0.705 x 0.000005 lb	2.68 x 0.00005 lb	4.85 x 0.00005 lb	7.05 x 0.00005 lb
	Pound x Ounce	0 lb, 4.30 oz x 0.01 oz	0 lb, 7.76 oz x 0.01 oz	0 lb, 11.29 oz x 0.01 oz	2 lb, 11.03 oz x 0.01 oz	4 lb, 13.60 oz x 0.01 oz	7 lb, 0.88 oz x 0.01 oz
	Troy Ounce	3.92 x 0.00005 ozt	7.07 x 0.00005 ozt	10.28 x 0.00005 ozt	39.2 x 0.0005 ozt	70.7 x 0.0005 ozt	102.8 x 0.0005 ozt
	Carat	610 x 0.005 ct	1100 x 0.005 ct	1600 x 0.005 ct	6100 x 0.05 ct	11000 x 0.05 ct	16000 x 0.05 ct
	Pennyweight	78.6 x 0.001 dwt	141.7 x 0.001 dwt	206.2 x 0.001 dwt	786 x 0.01 dwt	1417 x 0.01 dwt	2062 x 0.01 dwt
	Grain Unit	1882 x 0.02 GN	3395 x 0.02 GN	4938 x 0.02 GN	18827 x 0.2 GN	33951 x 0.2 GN	49383 x 0.2 GN

<sup>^</sup>Weighing Chamber

## Part Number/Price

PART #	MODEL #	DESCRIPTION	PRICE
98021	FX-120i	122 g x 0.001 g	\$980.00
98022	FX-200i	220 g x 0.001 g	1,030.00
98023	FX-300i	320 g x 0.001 g	1,060.00
168077	FX-300iNC	320 g x 0.001 g, Canada grams only	1,105.00
98024	FX-1200i	1220 g x 0.01 g	980.00
163641	FX-1200iN	1220 g x 0.01 g	1,035.00
168071	FX-1200iNC	1220 g x 0.01 g, Canada grams only	1,030.00
98025	FX-2000i	2200 g x 0.01 g	1,030.00
98026	FX-3000i	3200 g x 0.01 g	1,060.00

## Options/Accessories

PART #	A&D MODEL #	DESCRIPTION	PRICE
98027*	FXi-02	Quick USB interface	\$84.00
98028*	FXi-08	Ethernet interface with WinCT® Plus software	465.00
98029*	FXi-09	Built-in rechargeable battery	310.00
98030	FXi-10	Small breeze break	74.00
98031	FXi-11	Large breeze break	124.00
97649	TB:248	AC adapter (120V/220V)	41.00
151247	AD-1688	Data logger	295.00
158785	AD-8121B	Statistical printer	

\*Options FXi-02/FXi-08 and FXi-09 cannot be combined and are factory installed only.

## Standard Features

- Compact Super Hybrid Sensor Technology (SHS)
- Vacuum Fluorescent Display (VFD)
- GLP/GMP/ISO compliant to either AD-8121 printer or computer.  
Transmits date, time, ID number, serial number and calibration data
- Statistical calculation function
- RS-232C bidirectional communication
- Data memory function
- Comparator function
- Buzzer function
- Digital calibration function
- Optional built-in rechargeable battery
- Multiple units of measurement
- Response indicator function
- LAN-Ethernet interface
- WinCT® communication tools software
- Underhook weighing
- IP65 rating



## Specifications

	FX-120iWP <sup>^</sup>	FX-200iWP <sup>^</sup>	FX-300iWP <sup>^</sup>	FX-1200iWP	FX-2000iWP	FX-3000iWP	
<b>Part#</b>	<b>102905</b>	<b>102906</b>	<b>102907</b>	<b>102908</b>	<b>102909</b>	<b>102910</b>	
<b>List Price</b>	<b>\$1,440.00</b>	<b>\$1,518.00</b>	<b>\$1,621.00</b>	<b>\$1,435.00</b>	<b>\$1,518.00</b>	<b>\$1,616.00</b>	
Capacity	122 g	220 g	320 g	1220 g	2200 g	3200 g	
<b>Resolution</b>	<b>0.001 g</b>	<b>0.001 g</b>	<b>0.001 g</b>	<b>0.01 g</b>	<b>0.01 g</b>	<b>0.01 g</b>	
Repeatability		0.001 g			0.01 g		
Linearity		±0.002 g			±0.02 g		
Stabilization Time	Approx. 1 second						
Sensitivity Drift	±2 ppm/° C						
Display Refresh Rate	5 times / second, 10 times / second or 20 times / second						
Operating Temperature	41° F to 104° F (5° C to 40° C) 85% RH or less (No condensation)						
<b>Pan Size</b>	<b>Ø 5.12 in (130 mm)</b>			<b>Ø 5.90 in (150 mm)</b>			
Dimensions	6 W x 10.3 D x 3.3 in H (193 x 262.5 x 84.5 mm)						
Weight	Approx. 2.5 kg						
Est Ship Weight	8 lb (3.5 kg)						
External Calibration (weight optional)	100 g	200 g	300 g	1000 g	2000 g	3000 g	
Power Consumption	120/240VAC adapter, approx. 11 VA						
Warranty	Five-year limited warranty						
Return Policy	A&D Weighing Standard Policy - restock fee may apply						
UNIT OF MEASURE	Decimal Ounce	4.30 x 0.00005 oz	7.76 x 0.00005 oz	11.28 x 0.00005 oz	43.0 x 0.0005 oz	77.6 x 0.0005 oz	112.8 x 0.0005 oz
	Pound	0.268 x 0.000005 lb	0.485 x 0.000005 lb	0.705 x 0.000005 lb	2.68 x 0.00005 lb	4.85 x 0.00005 lb	7.05 x 0.00005 lb
	Pound x Ounce	0 lb, 4.30 oz x 0.01 oz	0 lb, 7.76 oz x 0.01 oz	0 lb, 11.29 oz x 0.01 oz	2 lb, 11.03 oz x 0.01 oz	4 lb, 13.60 oz x 0.01 oz	7 lb, 0.88 oz x 0.01 oz
	Troy Ounce	3.92 x 0.00005 ozt	7.07 x 0.00005 ozt	10.28 x 0.00005 ozt	39.2 x 0.0005 ozt	70.7 x 0.0005 ozt	102.8 x 0.0005 ozt
	Carat	610 x 0.005 ct	1100 x 0.005 ct	1600 x 0.005 ct	6100 x 0.05 ct	11000 x 0.05 ct	16000 x 0.05 ct
	Pennyweight	78.6 x 0.001 dwt	141.7 x 0.001 dwt	206.2 x 0.001 dwt	786 x 0.01 dwt	1417 x 0.01 dwt	2062 x 0.01 dwt
	Grain Unit	1882 x 0.02 GN	3395 x 0.02 GN	4938 x 0.02 GN	18827 x 0.2 GN	33951 x 0.2 GN	49383 x 0.2 GN

<sup>^</sup>Weighing Chamber

### Part Number/Price

PART #	MODEL #	DESCRIPTION	PRICE
102905	FXi-120iWP	122 g x 0.001 g	\$1,440.00
102906	FXi-200iWP	220 g x 0.001 g	1,518.00
102907	FXi-300iWP	320 g x 0.001 g	1,621.00
102908	FXi-1200iWP	1220 g x 0.01 g	1,435.00
102909	FXi-2000iWP	2200 g x 0.01 g	1,518.00
102910	FXi-3000iWP	3200 g x 0.01 g	1,616.00

### Options/Accessories

PART #	A&D MODEL #	DESCRIPTION	PRICE
98027*	FXi-02	Quick USB interface	\$84.00
98028*	FXi-08	Ethernet interface with WinCT® Plus software	465.00
98029*	FXi-09	Built-in rechargeable battery	310.00
98030	FXi-10	Small breeze break	74.00
98031	FXi-11	Large breeze break	124.00
97649	TB:248	AC adapter (120V/220V)	41.00

\*Options FXi-02/FXi-08 and FXi-09 can not be combined and are factory installed only.

**Standard Features**

- Can be easily and safely installed; requires no high-voltage wiring
- Eliminates static charges from quickly running or highly electrified work pieces
- Little or no reverse charge is induced by irradiated ions because of its excellent ion polarity or the potential of the charged object
- Achieves static elimination with a huge degree of efficiency regardless of the polarity or the potential of the charged object
- Suited for static elimination in narrow and remote places because of its lengthy ion irradiation distance
- Produces only a little amount of ozone thanks to its high ion generation efficiency
- A current limiting circuit is incorporated in the ion generating electrode to reduce the possibility of electric shock
- No swing in surface potential of the charged object



(Below) Example of AD-1683 installation showing static elimination area and an example of ion generation

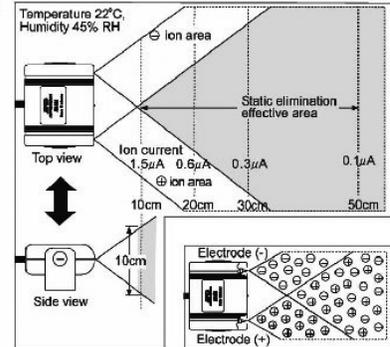

**Specifications**

<b>AD-1683</b>	
<b>Part #</b>	<b>97610</b>
<b>List Price</b>	<b>\$1,219.00</b>
Elimination Range	Distance: 10 to 30 cm from the electrode AREA: 30 x 30 cm
Static Elimination Method	DC corona discharge DUAL-DC
Static Eliminating Electrode	Tungsten emitter
Environmental Conditions	-5° C to 40° C, 35% to 85%RH (non-condensing)
Weight	300g
Power	100-240V AC, 50/60 Hz, 1.5V AC
Warranty	One-year limited
Return Policy	A&D Weighing Standard Policy - restock fee may apply

**Part Number/Price**

PART #	MODEL #	DESCRIPTION	PRICE
97610	AD-1683	Static eliminator, balance accessory	\$1,219.00

## Standard Features

- Easy-to-read seven segment LCD display with backlight
- 10 units of measurement
- Battery operated (4 AA not included)
- Selectable modes: weight, count, percentage and specific gravity
- 115VAC adapter included (230VAC optional)



## Specifications

	EJ-123 <sup>^</sup>	EJ-120	EJ-200	EJ-300	EJ-410	EJ-610
<b>Part#</b>	<b>163274</b>	<b>112410</b>	<b>112411</b>	<b>112412</b>	<b>112413</b>	<b>112414</b>
<b>List Price</b>	<b>\$515.00</b>	<b>\$270.00</b>	<b>\$300.00</b>	<b>\$370.00</b>	<b>\$420.00</b>	<b>\$520.00</b>
Capacity	120g	120g	210g	310g	410g	610g
<b>Resolution</b>	<b>0.001g</b>	<b>0.01g</b>	<b>0.01g</b>	<b>0.01g</b>	<b>0.01g</b>	<b>0.01g</b>
Operating Modes	Specific Gravity function, Counting, Percentage, Checkweighing					
Repeatability	0.003g	0.01g				
Linearity	0.003g	±0.01g			±0.02g	
Sensitivity Drift	20 ppm/° C 50° F to 86° F (10° C to 30° C)					
Display Type	7 segment LCD with backlight (character height 16 mm)					
Operating Temperature	14° F to 104° F (-10° C to 40° C) less than 85% R.H. (non-condensing)					
<b>Pan Size W x D</b>	<b>Ø 4.3 in (110 mm)</b>					
Physical Dimensions	7.5 W x 8.6 D x 2.2 in H (190 x 218 x 55 mm)					
Weight (approx.)	850g					
Calibration Mass (default setting)	100g	100g	200g	300g	400g	600g
Power	120VAC adapter (4 "AA" size dry-cell batteries - 70 hours operation)					
Warranty	Five-year limited warranty					
Return Policy	A&D Weighing Standard Policy - restock fee may apply					
Decimal Ounce	4.233 x 0.0001 oz	4.233 x 0.001 oz	7.408 x 0.001 oz	10.935 x 0.001 oz	14.462 x 0.001 oz	21.517 x 0.001 oz
Decimal Pound	N/A	N/A	N/A	N/A	0.9039 x 0.0001 lb	1.3448 x 0.0001 lb
Troy Ounce	3.858 x 0.0001 ozt	3.858 x 0.001 ozt	6.752 x 0.001 ozt	9.967 x 0.001 ozt	13.182 x 0.001 ozt	19.612 x 0.001 ozt
Pennyweight	77.16 x 0.001 dwt	77.16 x 0.01 dwt	135.03 x 0.01 dwt	199.33 x 0.01 dwt	263.64 x 0.01 dwt	392.24 x 0.01 dwt
Carat	600.00 x 0.005 ct	600.00 x 0.05 ct	1050.00 x 0.05 ct	1550.00 x 0.05 ct	2050.0 x 0.05 ct	3050.0 x 0.05 ct
Momme	N/A	32.000 x 0.005 mom	56.000 x 0.005 mom	82.665 x 0.005 mom	109.335 x 0.005 mom	162.665 x 0.05 mom
Grain Unit	1851.8 x 0.2 GN	1851.8 x 0.2 GN	3240.8 x 0.2 GN	4784.0 x 0.2 GN	6327.2 x 0.2 GN	9413.8 x 0.2 GN
Tael (H.K General)	N/A	3.1745 x 0.0005 TL	5.5555 x 0.0005 TL	8.2010 x 0.0005 TL	10.8465 x 0.0005 TL	16.1380 x 0.0005 TL
Tola	N/A	10.288 x 0.001 to	18.004 x 0.001 to	26.578 x 0.001 to	35.151 x 0.001 to	52.299 x 0.001 to

UNIT OF MEASURE

## Specifications

	EJ-1500	EJ-2000	EJ-3000	EJ-4100	EJ-6100	
<b>Part#</b>	<b>112415</b>	<b>112416</b>	<b>112417</b>	<b>112418</b>	<b>112419</b>	
<b>List Price</b>	<b>\$265.00</b>	<b>\$320.00</b>	<b>\$385.00</b>	<b>\$445.00</b>	<b>\$475.00</b>	
Capacity	1500 g	2100 g	3100 g	4100 g	6100 g	
<b>Resolution</b>	<b>0.1 g</b>	<b>0.1 g</b>	<b>0.1 g</b>	<b>0.1 g</b>	<b>0.1 g</b>	
Operating Modes	Specific Gravity function, Counting, Percentage, Checkweighing					
Repeatability	0.1 g					
Linearity	±0.1 g		±0.2 g			
Sensitivity Drift	20 ppm/C 50° F to 86° F (10° C to 30° C)					
Display Type	7 segment LCD with backlight (character height 16 mm)					
Operating Temperature	14° F to 104° F (-10° C to 40° C) less than 85% R.H. (non-condensing)					
<b>Pan Size W x D</b>	<b>5 x 5.5 in (127 x 140 mm)</b>					
Physical Dimensions	7.5 W x 8.6 D x 2.2 in H (190 x 218 x 55 mm)					
Weight (approx.)	1100 g					
Calibration Mass (default setting)	1500 g	2000 g	3000 g	4000 g	6000 g	
Power	120VAC adapter (4 "AA" size dry-cell batteries-70 hours operation)					
Warranty	Five-year limited warranty					
Return Policy	A&D Weighing Standard Policy - restock fee may apply					
UNIT OF MEASURE	Decimal Ounce	52.91 x 0.01 oz	74.08 x 0.01 oz	109.35 x 0.01 oz	144.62 x 0.01 oz	215.17 x 0.01 oz
	Decimal Pound	3.307 x 0.001 lb	4.630 x 0.001 lb	6.834 x 0.001 lb	9.039 x 0.001 lb	13.4488 x 0.001 lb
	Troy Ounce	48.23 x 0.01 ozt	67.52 x 0.01 ozt	99.67 x 0.01 ozt	131.82 x 0.01 ozt	196.12 x 0.01 ozt
	Pennyweight	964.5 x 0.1 dwt	1350.3 x 0.1 dwt	1993.3 x 0.1 dwt	2636.4 x 0.1 dwt	3922.4 x 0.1 dwt
	Carat	-	-	-	-	-
	Momme	4000.00 x 0.05 mom	560.00 x 0.05 mom	826.65 x 0.05 mom	1093.35 x 0.05 mom	1626.65 x 0.05 mom
	Grain Unit	23148 x 2 GN	32408 x 2 GN	47840 x 2 GN	63272 x 2 GN	94138 x 2 GN
	Tael (H.K General)	39.685 x 0.005 TL	55.555 x 0.005 TL	82.01 x 0.005 TL	108.465 x 0.005 TL	161.380 x 0.005 TL
	tola	128.6 x 0.01 to	180.04 x 0.01 to	265.78 x 0.01 to	351.51 x 0.01 to	522.99 x 0.01 to

## Part Number/Price

PART #	MODEL #	DESCRIPTION	PRICE
163274	EJ-123	120 g X 0.001 g	\$515.00
112410	EJ-120	120 g x 0.01 g	270.00
112411	EJ-200	210 g x 0.01 g	300.00
112412	EJ-300	310 g x 0.01 g	370.00
112413	EJ-410	410 g x 0.01 g	420.00
112414	EJ-610	610 g x 0.01 g	520.00
112415	EJ-1500	1500 g x 0.1 g	265.00
112416	EJ-2000	2100 g x 0.1 g	320.00
112417	EJ-3000	3100 g x 0.1 g	385.00
112418	EJ-4100	4100 g x 0.1 g	445.00
112419	EJ-6100	6100 g x 0.1 g	475.00

## Options/Accessories

PART #	A&D MODEL #	DESCRIPTION	PRICE
112426	EJ-02	USB interface with cable	\$81.00
112427	EJ-03	RS-232 interface with cable	71.00
112428	EJ-07	Underhook for EJ-3000, EJ-4100 and EJ-6100	62.00
112429	EJ-08	Underhook for EJ-1500 and EJ-2000	62.00
112430	EJ-11	Breeze break	62.00
112431	EJ-12	Carrying case	62.00
112432	EJ-13	Density determination kit	73.00
97766	TB:163C	AC Adapter, 120V	41.00
97767	TB:164	AC Adapter, 220V	50.00
151247	AD-1688	Data logger	295.00



## Standard Features

- Backlit weight display
- Remote zeroing
- Easy to install NiCAD battery option
- Nine weighing modes
- RS-232C bidirectional interface



## Approvals



## Specifications

	EK-120i	EK-200i	EK-300i	EK-410i	EK-610i	EK-600i	EK-1200i
<b>Part#</b>	97747	97748	97749	97750	97751	-	-
<b>List Price</b>	\$505.00	\$535.00	\$560.00	\$625.00	\$730.00	-	-
<b>NTEP Part#</b>	-	-	-	-	-	97752	97753
<b>NTEP List Price</b>	-	-	-	-	-	\$505.00	\$520.00
<b>Capacity</b>	120 g	200 g	300 g	400 g	600 g	600 g	1200 g
<b>Resolution</b>	0.01 g	0.01 g	0.01 g	0.01 g	0.01 g	0.1 g	0.1 g
<b>Operating Modes</b>	Counting, Percentage						
<b>Repeatability</b>	0.01 g					0.1 g	
<b>Linearity</b>	±0.01 g		±0.02 g			±0.1 g	
<b>Sensitivity Drift</b>	20 ppm/C 50° F to 86° F (10° C to 30° C)						
<b>Display Type</b>	7 segment LCD with backlight (character height 16 mm)						
<b>Operating Temperature</b>	14° F to 104° F (-10° C to 40° C) less than 85% R.H. (non-condensing)						
<b>Pan Size W x D</b>	Ø 4.3 in (110mm)					5.2 in x 6.7 in (133 x 170mm)	
<b>Physical Dimensions</b>	7.5 W x 8.6 D x 2.2 in H (190 x 218 x 55 mm)						
<b>Weight (approx.)</b>	2.4 lb (1.1 kg)					3.5 lb (1.5 kg)	
<b>Calibration Mass (default setting)</b>	120 g	200 g	300 g	400 g	600 g	600 g	1200 g
<b>Power</b>	120VAC adapter (Optional Ni-MH battery pack)						
<b>Approvals</b>	-					NTEP CC 04-019	
<b>Warranty</b>	Five-year limited warranty						
<b>Return Policy</b>	A&D Weighing Standard Policy - restock fee may apply						
<b>UNIT OF MEASURE</b>							
<b>Decimal Ounce</b>	4.2330 x 0.0005 oz	7.0550 x 0.0005 oz	10.5820 x 0.0005 oz	14.110 x 0.001 oz	21.164 x 0.001 oz	21.165 x 0.005 oz	42.330 x 0.005 oz
<b>Decimal Pound</b>	-	-	-	0.8818 x 0.0001 lb	1.3228 x 0.0001 lb	1.3230 x 0.0005 lb	2.6455 x 0.0005 lb
<b>Troy Ounce</b>	3.8580 x 0.0005 ozt	6.4300 x 0.0005 ozt	9.6450 x 0.0005 ozt	12.860 x 0.001 ozt	19.290 x 0.001 ozt	19.290 x 0.005 ozt	38.580 x 0.005 ozt
<b>Pennyweight</b>	77.16 x 0.01 dwt	128.60 x 0.01 dwt	192.90 x 0.01 dwt	257.21 x 0.01 dwt	385.81 x 0.01 dwt	385.8 x 0.1 dwt	771.6 x 0.1 dwt
<b>Carat</b>	600.00 x 0.05 ct	1000.00 x 0.05 ct	1500.00 x 0.05 ct	2000.0 x 0.1 ct	3000.0 x 0.1 ct	3000.0 x 0.5 ct	6000.0 x 0.5 ct
<b>Momme</b>	32.000 x 0.005 mom	53.335 x 0.005 mom	80.000 x 0.005 mom	106.665 x 0.005 mom	160.000 x 0.005 mom	160.00 x 0.05 mom	320.00 x 0.05 mom
<b>Grain Unit</b>	1851.8 x 0.2 GN	3086.4 x 0.2 GN	4629.8 x 0.2 GN	6173.0 x 0.2 GN	9259.4 x 0.2 GN	92594 x 2 GN	18518 x 2 GN
<b>Tael (H.K General)</b>	3.1745 x 0.0005 TL	5.2910 x 0.0005 TL	7.9365 x 0.0005 TL	10.5820 x 0.0005 TL	15.8735 x 0.0005 TL	15.875 x 0.005 TL	31.745 x 0.005 TL

## Specifications

	EK-2000i	EK-3000i	EK-4100i	EK-6100i	EK-6000i	EK-12Ki
<b>Part#</b>	97754	97755	97756	97757	-	-
<b>List Price</b>	\$550.00	\$585.00	\$705.00	\$860.00	-	-
<b>NTEP Part#</b>	-	-	-	-	97758	97759
<b>NTEP List Price</b>	-	-	-	-	\$550.00	\$700.00
<b>Capacity</b>	2000 g	3000 g	4000 g	6000g	6000 g	12000 g
<b>Resolution</b>	0.1 g	0.1 g	0.1 g	0.1 g	1 g	1 g
<b>Operating Modes</b>	Counting, Percentage					
<b>Repeatability</b>	0.1 g				1 g	
<b>Linearity</b>	±0.1 g	±0.2 g			±1 g	
<b>Sensitivity Drift</b>	20 ppm/° C 50° F to 86° F (10° C to 30° C)					
<b>Display Type</b>	7 segment LCD with backlight (character height 16 mm)					
<b>Operating Temperature</b>	14° F to 104° F (-10° C to 40° C) less than 85% R.H. (non-condensing)					
<b>Pan Size W x D</b>	5.2 x 6.7 in (133 x 170 mm)					
<b>Physical Dimensions</b>	7.5 W x 8.6 D x 2.2 in H 190 x 218 x 55 mm					
<b>Weight (approx.)</b>	3.5 lb (1.5 kg)					
<b>Calibration Mass (default setting)</b>	2000 g	3000 g	4000 g	6000 g	12 kg	
<b>Power</b>	120VAC adapter (Optional Ni-MH battery pack)					
<b>Approvals</b>	-				NTEP CC 04-019	
<b>Warranty</b>	Five-year limited warranty					
<b>Return Policy</b>	A&D Weighing Standard Policy - restock fee may apply					
<b>UNIT OF MEASURE</b>						
Decimal Ounce	70.550 x 0.005 oz	105.820 x 0.005 oz	141.10 x 0.01 oz	211.64 x 0.01 oz	211.65 x 0.05 oz	423.30 x 0.05 oz
Decimal Pound	4.4090 x 0.0005 lb	6.6140 x 0.0005 lb	8.818 x 0.001 lb	13.228 x 0.001 lb	13.230 x 0.005 lb	26.455 x 0.005 lb
Troy Ounce	64.300 x 0.005 ozt	96.450 x 0.005 ozt	128.60 x 0.01 ozt	192.90 x 0.01 ozt	192.90 x 0.05 ozt	385.80 x 0.05 ozt
Pennyweight	1286.0 x 0.1 dwt	1929.0 x 0.1 dwt	2572.1 x 0.1 dwt	3858.1 x 0.1 dwt	3858 x 1 dwt	7716 x 1 dwt
Carat	10000.0 x 0.5 ct	15000.0 x 0.5 ct	20000 x 1 ct	30000 x 1 ct	-	-
Momme	533.35 x 0.05 mom	800.00 x 0.05 mom	1066.65 x 0.05 mom	1600.00 x 0.05 mom	1600.0 x 0.5 mom	3200.0 x 0.5 mom
Grain Unit	30864 x 2 GN	46298 x 2 GN	61730 x 2 GN	92594 x 2 GN	-	-
Tael (H.K General)	52.910 x 0.005 TL	79.365 x 0.005 TL	105.820 x 0.005 TL	158.735 x 0.005 TL	158.75 x 0.05 TL	317.45 x 0.05 TL

### Part Number/Price

PART #	MODEL #	DESCRIPTION	PRICE
97747	EK-120i	120 g x 0.01 g	\$505.00
97748	EK-200i	200 g x 0.01 g	535.00
97749	EK-300i	300 g x 0.01 g	560.00
97750	EK-410i	400 g x 0.01 g	625.00
97751	EK-610i	600 g x 0.01 g	730.00
97752	EK-600i (NTEP)	600 g x 0.1 g	505.00
97753	EK-1200i (NTEP)	1200 g x 0.1 g	520.00
97754	EK-2000i	2000 g x 0.1 g	550.00
97755	EK-3000i	3000 g x 0.1 g	585.00
97756	EK-4100i	4000 g x 0.1 g	705.00
97757	EK-6100i	6000 g x 0.1 g	860.00
97758	EK-6000i (NTEP)	6000 g x 1 g	550.00
97759	EK-12Ki (NTEP)	12000 g x 1 g	700.00

### Options/Accessories

PART #	A&D MODEL #	DESCRIPTION	PRICE
97760	EKW-04i	Comparator/relay outputs/buzzer	\$152.00
97761	EKW-07i	Underhook for EK-4100i/6100i/6000i/12Ki/EW-12Ki	50.00
97762	EKW-09i	NiCad battery pack	202.00
97764	AX:3005824-5S	Dust cover	12.00
97605	AD-100-2	Anti-theft device	70.00
97766	TB:163C	AC adapter (120V)	41.00
97767	TB:164	AC adapter (240V)	50.00
151247	AD-1688	Data logger	295.00

### Standard Features

- Backlit weight display
- Remote zeroing
- Easy to install NiCad battery option
- RS-232C bidirectional interface
- Counting/Percentage/Comparator Modes
- Triple Range



### Approvals



### Specifications

	EW-150i			EW-1500i			EW-12Ki		
Part#	97768			-			-		
List Price	\$410.00			-			-		
<b>NTEP</b> Part#	-			97769			97771		
<b>NTEP</b> List Price	-			\$410.00			\$410.00		
Capacity	30 g	60 g	150 g	300 g	600 g	1500 g	3000 g	6000 g	12000 g
Resolution	0.01 g	0.02 g	0.05 g	0.1 g	0.2 g	0.5 g	1 g	2 g	5 g
Operating Mode	Counting, Percentage								
Repeatability	0.01 g	0.02 g	0.05 g	0.1 g	0.2 g	0.5 g	1 g	2 g	5 g
Linearity	±0.01 g	±0.02 g	±0.05 g	±0.1 g	±0.2 g	±0.5 g	±1 g	±2 g	±5 g
Sensitivity Drift	20 ppm/° C (10° C to 30° C/50° F to 86° F)								
Operating temperature	14° F to 104° F (-10° C to 40° C) less than 85% R.H. (non-condensing)								
Pan Size	Ø 4.3 in (110 mm)			5.2 x 6.7 in (133 x 170 mm)					
Dimensions	7.5 W x 8.6 D x 2.2 in H (190 x 218 x 55 mm)								
Weight	2.4 lb (1.1 kg)			3.5 lb (1.5 kg)					
Calibration Mass (default setting)	150 g			1500 g			12 kg		
Power	AC adapter or Ni-MH battery pack (option)								
Approvals	-			NTEP CC 04-019			NTEP CC 04-019		
Warranty	Five-year limited warranty								
Return Policy	A&D Weighing Standard Policy - restock fee may apply								
<b>UNIT OF MEASURE</b> Decimal Ounce	1.0580 x 0.0005 oz	2.116 x 0.001 oz	5.292 x 0.002 oz	10.580 x 0.005 oz	21.16 x 0.01 oz	52.92 x 0.02 oz	105.80 x 0.05 oz	211.6 x 0.1 oz	423.2 x 0.2 oz
Decimal Pound				0.6615 x 0.0005 lb	1.323 x 0.001 lb	3.306 x 0.002 lb	6.615 x 0.005 lb	13.23 x 0.01 lb	26.46 x 0.02 lb
Troy Ounce	0.9645 x 0.0005 ozt	1.929 x 0.001 ozt	4.822 x 0.002 ozt	9.645 x 0.005 ozt	19.29 x 0.01 ozt	48.22 x 0.02 ozt	96.45 x 0.05 ozt	192.9 x 0.1 ozt	385.8 x 0.2 ozt
Pennyweight	19.29 x 0.01 dwt	38.58 x 0.02 dwt	96.45 x 0.05 dwt	192.9 x 0.1 dwt	385.8 x 0.2 dwt	964.5 x 0.5 dwt	1929 x 1 dwt	3858 x 2 dwt	7715 x 5 dwt
Carat	150.00 x 0.05 ct	300.0 x 0.1 ct	750.0 x 0.2 ct	1500.0 x 0.5 ct	3000 x 1 ct	7500 x 2 ct	-	-	-
Momme	8.000 x 0.005 mom	16.00 x 0.01 mom	40.00 x 0.02 mom	80.00 x 0.05 mom	160.0 x 0.1 mom	400 x 0.2 mom	800 x 0.5 mom	1600 x 1 mom	3200 x 2 mom
Grain Unit	463.0 x 0.2 GN	926.0 x 0.5 GN	2315 x 1 GN	4630 x 2 GN	9260 x 5 GN	23150 x 10 GN	-	-	-
Tael (H.K General)	0.7935 x 0.0005 TL	1.587 x 0.001 TL	3.968 x 0.002 TL	7.935 x 0.005 TL	15.87 x 0.01 TL	39.68 x 0.02 TL	79.35 x 0.05 TL	158.7 x 0.1 TL	317.4 x 0.2 TL

### Part Number/Price

PART #	MODEL #	DESCRIPTION	PRICE
97768	EW-150i	30 g x 0.01 g / 60 g x 0.02 g / 150 g x 0.05 g	\$410.00
97769 (NTEP)	EW-1500i	300 g x 0.1 g / 600 g x 0.2 g / 1500 g x 0.5 g	410.00
97771 (NTEP)	EW-12Ki	3000 g x 1 g / 6000 x 2 g / 12000 g x 5 g	410.00

### Options/Accessories

PART #	A&D MODEL #	DESCRIPTION	PRICE
97760	EKW-04i	Comparator/relay outputs/buzzer	\$152.00
97761	EKW-07i	Underhook for EK-4100i/6100i/6000i/12Ki/EW-12Ki	50.00
97762	EKW-09i	NiCad battery pack	202.00
97764	AX:3005824-5S	Protective dust cover (not in use)	12.00
97765	EJ-12	Carrying case	61.00
97605	AD-100-2	Anti-theft device	70.00
97766	TB:163C	AC adapter (120V)	41.00
97767	TB:164	AC adapter (240V)	50.00
151247	AD-1688	Data logger	295.00

## Standard Features

- Internal calibration
- Auto environmental compensation
- IP65/NEMA4
- RS-232C bidirectional interface
- Data memory function
- Multiple weighing modes
- Quick reference operation card
- Time and date
- Vacuum Fluorescent Display (VFD)
- Underhook weighing



## Specifications

	GX-8K	GX-8K2	GX-10K	GX-12K	
<b>Part#</b>	<b>97776</b>	<b>97775</b>	<b>97777</b>	<b>97778</b>	
<b>List Price</b>	<b>\$3,465.00</b>	<b>\$2,995.00</b>	<b>\$3,695.00</b>	<b>\$3,145.00</b>	
Capacity	8.1 kg	8.1 kg/2.1 kg	10.1 kg	12 kg	
<b>Resolution</b>	<b>0.01 g</b>	<b>0.1 g / 0.01 g</b>	<b>0.01 g</b>	<b>0.1 g</b>	
Operating Modes	Counting, percentage				
Repeatability	0.01 g	0.05 g/0.01 g	0.01 g	0.1 g	
Linearity	±0.02 g	±0.1 g/±0.02 g	±0.03 g	±0.2 g	
Sensitivity drift (-10° C to +30° C)	±2 ppm/° C	±3 ppm/° C	±2 ppm/° C	±3 ppm/° C	
Stabilization time	Approx 1.5 seconds				
Operating temperature	41° F to 104° F (-5° C to 40° C)				
<b>Pan Size</b>	<b>10.62 x 8.26 in (270 x 210 mm)</b>				
Dimensions	11.81 x 13.98 x 4.37 in (300 x 355 x 111 mm)				
Weight	18.3 lb (8.3 kg)				
External cal mass	2, 3, 4, 5, 6, 7, 8 kg		10 kg	5, 10 kg	
Power	120/240 V AC adapter				
Warranty	Five-year limited warranty				
Return Policy	A&D Weighing Standard Policy - restock fee may apply				
UNIT OF MEASURE	Decimal Ounces	285.7190 x 0.0005 oz	285.720 x 0.005/74.0755 x 0.0005 oz	370.4 x 0.0005 oz	423.290 x 0.005 oz
	Troy Ounce	260.4210 x 0.0005 ozt	260.420 x 0.005/67.5165 x 0.0005 ozt	337.6 x 0.0005 ozt	385.810 x 0.005 ozt
	Pennyweight	5208.42 x 0.01 dwt	5208.4 x 0.1/1350.33 x 0.01 dwt	6751 x 0.01 dwt	7716.2 x 0.1 dwt
	Carat	40500.00 x 0.05 ct	40500.0 x 0.5/10500.00 x 0.05 ct	50500 x 0.05 ct	60000 x 0.5 ct
	Momme	2160.000 x 0.005 mom	2160.00 x 0.05/560.000 x 0.005 mom	2800.000 x 0.005 mom	3200.00 x 0.05 mom
	Grain	125002.2 x 0.2 GN	125002 x 2/32408.0 x 0.2 GN	162040 x 0.2 GN	185188 x 2 GN
	Pound	17.85745 x 0.00005 lb	17.8575 x 0.0005/4.62970 x 0.00005 lb	23.15 x 0.00005 lb	26.4555 x 0.0005 lb
	Pound/Ounce	17 13.719 x 0.001 lb	17 13.72 x 0.01/ 4 10.075 x 0.001 lb	23 2.4 x 0.001 lb	26 7.29 x 0.01 lb

## Specifications

	GX-20K	GX-30K	GX-32K	
<b>Part #</b>	<b>97779</b>	<b>97780</b>	<b>97781</b>	
<b>List Price</b>	<b>\$3,395.00</b>	<b>\$3,925.00</b>	<b>\$3,045.00</b>	
Capacity	20 kg	30 kg	30 kg/6.1 kg	
<b>Resolution</b>	<b>0.1 g</b>	<b>0.1 g</b>	<b>1/0.1 g</b>	
Operating Modes	Counting, percentage			
Repeatability	0.1 g	0.1 g	0.5 g / 0.1 g	
Linearity	±0.2 g	±0.2 g	±1 g / ±0.2 g	
Sensitivity drift (-10 to 30° C)	±3 ppm/° C		±5 ppm/° C	
Stabilization Time	Approx 1.5 seconds			
Operating Temperature	41°F - 104°F (-5°C - 40°C)			
<b>Pan Size</b>	<b>10.62 x 8.26 in (270 x 210 mm)</b>			
Dimensions	11.81 x 13.98 x 4.37 in (300 x 355 x 111 mm)			
Weight	18.3 lb (8.3 kg)			
External Cal Mass	10, 20 kg	20, 30 kg	20, 30 kg	
Power	120/240VAC adapter			
Warranty	Five-year limited warranty			
Return Policy	A&D Weighing Standard Policy - restock fee may apply			
UNIT OF MEASURE	Decimal Ounces	740.755 x 0.005 oz	1093.495 x 0.005 oz	1093.50 x 0.05/ 215.170 x 0.005 oz
	Troy Ounce	675.165 x 0.005 ozt	996.675 x 0.005 ozt	996.65 x 0.05/ 196.120 x 0.005 ozt
	Pennyweight	13503.3 x 0.1 dwt	19933.5 x 0.1 dwt	19933 x 1/ 3922.4 x 0.1 dwt
	Carat	105000.0 x 0.5 ct	155000.0 x 0.5 ct	155000 x 5/ 30500.0 x 0.5 ct
	Momme	5600.00 x 0.05 mom	8266.65 x 0.05 mom	8266.5 x 0.5/ 1626.65 x 0.05 mom
	Grain	324080 x 2 GN	478404 x 2 GN	-
	Pound	46.2970 x 0.0005 lb	68.3435 x 0.0005 lb	68.345 x 0.005/ 13.4480 x 0.0005 lb
	Pound/Ounce	46 4.75 x 0.010 lb	68 5.49 x 0.01 lb	68 5.5 x 0.1/ 13 7.17 x 0.01 lb

## Part Number/Price

PART #	MODEL #	DESCRIPTION	PRICE
97776	GX-8K	8.1 kg x 0.01 g	\$3,465.00
97775	GX-8K2	8.1/2.1 kg x 0.1/0.01 g	2,995.00
97777	GX-10K	10.0 kg x 0.01 g	3,695.00
97778	GX-12K	12 kg x 0.1 g	3,145.00
97779	GX-20K	20 kg x 0.1 g	3,395.00
97780	GX-30K	30 kg x 0.1 g	3,925.00
97781	GX-32K	30/6.1 kg x 1/0.1 g	3,045.00

## Options/Accessories

PART #	A&D MODEL #	DESCRIPTION	PRICE
97782	GX-04K*	Comparator/output and RS-232C/20 mA interface	\$355.00
97783	GX-06K*	Analog output/20 mA interface	815.00
97784	GX-07K**	Waterproof cable for standard RS-232C	302.00
97605	AD-100-2	Anti-theft device	67.00
97785	AX-073007197A	Protective in-use cover	18.00
97649	TB:248	AC adapter (120/240V)	41.00
102898	GXK-31	Draft shield	112.00
102899	GXK-12	Animal weighing pan	811.00
151247	AD-1688	Data logger	295.00
158785	AD-8121B	Dot matrix statistical printer, includes cable	865.00

\*GX-04K, GX-06K, replace standard RS-232C and cannot be used at the same time. IP65 rating does not apply when the GX-04K or the GX-06K is installed.

\*\*Use the GX-07K optional waterproof RS-232C cable, in order to use the standard RS-232 interface for water and dust proof (IP65)

## Standard Features

- IP65/NEMA4
- RS-232C bidirectional interface
- Multiple weighing modes
- Quick reference operation card
- Time and date
- Vacuum fluorescent display (VFD)
- Interval time setting
- Underhook weighing



## Specifications

	GF-8K	GF-8K2	GF-10K	GF-12K
<b>Part #</b>	<b>97793</b>	<b>97792</b>	<b>97794</b>	<b>97795</b>
<b>List Price</b>	<b>\$3,275.00</b>	<b>\$2,775.00</b>	<b>\$3,495.00</b>	<b>\$2,945.00</b>
Capacity	8.1 kg	2.1/8.1 kg	10.1 kg	12 kg
<b>Resolution</b>	<b>0.01 g</b>	<b>0.01/0.1 g</b>	<b>0.01 g</b>	<b>0.1 g</b>
Operating Modes	Counting, Percentage			
Linearity	±0.02 g	±0.1 g/±0.02 g	±0.03 g	±0.2 g
Stabilization Time	Approx. 1.5 seconds (typical in FAST mode)			
Repeatability	0.01 g	0.05 g/0.01 g	0.01 g	0.1 g
Sensitivity Drift (10° C to 30° C)	±2 ppm/° C	±3 ppm/° C	±2 ppm/° C	±3 ppm/° C
Display Refresh	5 times per second/10 times per second			
Operating Temperature	41° F to 104° F (5° C to 40° C) RH less than 85% (No condensation)			
<b>Pan Size</b>	<b>Stainless steel 10.62 W x 8.26 in D (270 x 210 mm)</b>			
Dimensions	11.81 W x 13.98 D x 4.37 in H (300 x 355 x 111 mm)			
Weight	18.3 lb (8.3 kg)			
External Cal. Mass	2, 3, 4, 5, 6, 7, 8 kg		10 kg	5, 10 kg
Power	120/240V AC adapter			
Warranty	Five-year limited warranty			
Return Policy	A&D Weighing Standard Policy - restock fee may apply			
Decimal Ounces	285.7190 x 0.0005 oz	285.720 x 0.005/74.0755 x 0.0005 oz	370.4 x 0.0005 oz	423.290 x 0.005 oz
Troy Ounce	260.4210 x 0.0005 ozt	260.420 x 0.005/67.5165 x 0.0005 ozt	337.6 x 0.0005 ozt	385.810 x 0.005 ozt
Pennyweight	5208.42 x 0.01 dwt	5208.4 x 0.1/1350.33 x 0.01 dwt	6751 x 0.01 dwt	7716.2 x 0.1 dwt
Carat	40500.00 x 0.05 ct	40500.0 x 0.5/10500.00 x 0.05 ct	50500 x 0.05 ct	60000 x 0.5 ct
Momme	2160.000 x 0.005 mom	2160.00 x 0.05/560.000 x 0.005 mom	2800.000 x 0.005 mom	3200.00 x 0.05 mom
Grain	125002.2 x 0.2 GN	125002 x 2/32408.0 x 0.2 GN	162040 x 0.2 GN	185188 x 2 GN
Pound	17.85745 x 0.00005 lb	17.8575 x 0.0005/4.62970 x 0.00005 lb	23.15 x 0.00005 lb	26.4555 x 0.0005 lb
Pound/Ounce	17 13.719 x 0.001 lb	17 13.72 x 0.01/4 10.075 x 0.001 lb	23 2.4 x 0.001 lb	26 7.29 x 0.01 lb

UNIT OF MEASURE



## Specifications

	GF-20K	GF-30K	GF-32K	
<b>Part#</b>	<b>97796</b>	<b>97797</b>	<b>97798</b>	
<b>List Price</b>	<b>\$3,145.00</b>	<b>\$3,695.00</b>	<b>\$2,795.00</b>	
Capacity	21 kg	31 kg	6.1/31 kg	
<b>Resolution</b>	<b>0.1 g</b>	<b>0.1 g</b>	<b>0.1/1 g</b>	
Operating Modes	Counting, Percentage			
Linearity	±0.2 g		±1 g/0.2 g	
Stabilization time	Approx. 1.5 seconds (typical in FAST mode)			
Repeatability	0.1 g		0.5 g/0.1 g	
Sensitivity Drift (10° C to 30° C)	±3 ppm/° C		±5 ppm/° C	
Display refresh	5 times per second / 10 times per second			
Operating Temperature	41° F to 104° F (5° C to 40° C) RH less than 85% (No condensation)			
<b>Pan Size</b>	<b>Stainless steel 10.62 W x 8.26 in D (270 x 210 mm)</b>			
Dimensions	11.81 W x 13.98 D x 4.37 in H (300 x 355 x 111 mm)			
Weight	18.3 lb (8.3 kg)			
External Cal. Mass	10, 20 kg	20, 30 kg		
Power	120/240VAC adapter			
Warranty	Five-year limited warranty			
Return Policy	A&D Weighing Standard Policy - restock fee may apply			
UNIT OF MEASURE	Decimal Ounces	740.755 x 0.005 oz	1093.495 x 0.005 oz	1093.50 x 0.05/215.170 x 0.005 oz
	Troy Ounce	675.165 x 0.005 ozt	996.675 x 0.005 ozt	996.65 x 0.05/196.120 x 0.005 ozt
	Pennyweight	13503.3 x 0.1 dwt	19933.5 x 0.1 dwt	19933 x 1/3922.4 x 0.1 dwt
	Carat	105000.0 x 0.5 ct	155000.0 x 0.5 ct	155000 x 5/30500.0 x 0.5 ct
	Momme	5600.00 x 0.05 mom	8266.65 x 0.05 mom	8266.5 x 0.5/1626.65 x 0.05 mom
	Grain	324080 x 2 GN	478404 x 2 GN	N/A
	Pound	46.2970 x 0.0005 lb	68.3435 x 0.0005 lb	68.345 x 0.005/13.4480 x 0.0005 lb
	Pound/Ounce	46 4.75 x 0.010 lb	68 5.49 x 0.01 lb	68 5.5 x 0.1/13 7.17 x 0.01 lb

## Part Number/Price

PART #	MODEL #	DESCRIPTION	PRICE
97792	GF-8K2	2.1/8.1 kg x 0.01/0.1 g	\$2,775.00
97793	GF-8K	8.1 kg x 0.01 g	3,275.00
97794	GF-10K	10.1 kg x 0.01 g	3,495.00
97795	GF-12K	12 kg x 0.1 g	2,945.00
97796	GF-20K	21 kg x 0.1 g	3,145.00
97797	GF-30K	31 kg x 0.1 g	3,695.00
97798	GF-32K	31/6.1 kg x 1/0.1 g	2,795.00

## Options/Accessories

PART #	A&D MODEL #	DESCRIPTION	PRICE
97782	GX-04K*	Comparator/output and RS-232C/20 mA interface	\$355.00
97783	GX-06K*	Analog output/20 mA interface	815.00
97784	GX-07K**	Waterproof cable for standard RS-232C	302.00
97605	AD-100-2	Anti-theft device	67.00
97785	AX:073007197A	Protective in-use cover	18.00
97649	TB:237	AC adapter (120V/220V)	41.00
102898	GXK-31	Draft shield	112.00
102899	GXK-12	Animal weighing pan	811.00
151247	AD-1688	Data logger	295.00
158785	AD-8121B	Impact dot matrix statistical printer, includes cable	865.00

\*GX-04K, GX-06K, replace standard RS-232C and cannot be used at the same time. IP65 rating does not apply when the GX-04K or the GX-06K is installed.

\*\*Use the GX-07K optional waterproof RS-232C cable, in order to use the standard RS-232 interface for water and dust proof (IP65)

## Standard Features

- IP65/NEMA4
- Internal calibration weight with manual, interval or auto-environmental compensation
- RS-232C bidirectional interface
- Data-collection software
- Auto re-zero function
- Multiple weighing modes
- Time and date
- Bright blue fluorescent display
- Adjustable swing arm display
- Die cast aluminum body with stainless weighing pan
- Detached digital weight indicator (KS models only)



## Specifications

	GP-12K	GP-20K	GP-30K	GP-30KS*	GP-32K	GP-32KS*	GP-40K	
<b>Part#</b>	<b>97802</b>	<b>97803</b>	<b>97805</b>	<b>97810</b>	<b>97804</b>	<b>102901</b>	<b>97806</b>	
<b>List Price</b>	<b>\$3,395.00</b>	<b>\$3,725.00</b>	<b>\$4,445.00</b>	<b>\$4,685.00</b>	<b>\$3,025.00</b>	<b>\$3,375.00</b>	<b>\$4,025.00</b>	
Capacity	12 kg	21 kg	31 kg		31 kg/6 kg		41 kg	
<b>Resolution</b>	<b>0.1 g</b>	<b>0.1 g</b>	<b>0.1 g</b>		<b>1/0.1 g</b>		<b>0.5 g</b>	
Operating Modes	Counting, percentage							
Repeatability	0.1 g	0.1 g	0.1 g	-	0.5/ 0.1 g	-	0.5 g	
Linearity	±0.2g	±0.2g	±0.2g	-	±1 / ±2g	-	±1 g	
Sensitivity Drift (-10° C to +30 ° C)	±3 ppm/° C				±5 ppm/° C			
Stabilization Time	Approx. 1.5 seconds (typical in FAST mode)							
Operating Temperature	41° F to 104° F (5° C to 40° C) RH less than 85% (No condensation)							
<b>Pan Size</b>	<b>Stainless steel 15 x 13 in (384 x 344 mm)</b>							
Dimensions	14.6 W x 24.2 D x 5.1 in H 372 x 615 x 130 mm		13.5 W x 17.4 D x 5.5 in H (344 x 442 x 139 mm)		14.6 W x 24.2 D x 5.1 in H (372 x 615 x 130 mm)			
Height with Column	652 mm							
Weight	Approx 37.4 lb (17 kg)							
External Cal Mass	5 kg/10 kg	10 kg/20 kg	20 kg/30 kg				20/30/40 kg	
Warranty	Five-year limited warranty							
Return Policy	A&D Weighing Standard Policy - restock fee may apply							
UNIT OF MEASURE	Decimal Ounces	423.290 x 0.005 oz	740.755 x 0.005 oz	1093.495 x 0.005 oz		1093.50 x 0.05/215.170 x 0.005 oz		1446.24 x 0.02 oz
	Troy Ounce	385.810 x 0.005 ozt	675.165 x 0.005 ozt	996.675 x 0.005 ozt		996.65 x 0.05/196.120 x 0.005 ozt		1318.18 x 0.02 ozt
	Pennyweight	7716.2 x 0.1 dwt	13503.3 x 0.1 dwt	19933.5 x 0.1 dwt		19933 x 1/3922.4 x 0.1 dwt		26363.5 x 0.5 dwt
	Carat	60000 x 0.5 ct	105000.0 x 0.5 ct	155000.0 x 0.5 ct		155000 x 5/30500.0 x 0.5 ct		205000 x 5 ct
	Momme	3200.00 x 0.05 mom	5600.00 x 0.05 mom	8266.65 x 0.05 mom		8266.5 x 0.5/1626.65 x 0.05 mom		10933.4 x 0.2 mom
	Grain	185188 x 2 GN	324080 x 2 GN	478404 x 2 GN		-		-
	Pound	26.4555 x 0.0005 lb	46.2970 x 0.0005 lb	68.3435 x 0.0005 lb		68.345 x 0.005/13.4480 x 0.0005 lb		90.390 x 0.002 lb
	Pound/Ounce	26 7.29 x 0.01 lb	46 4.75 x 0.010 lb	68 5.49 x 0.01 lb		68 5.5 x 0.1/13 7.17 x 0.01 lb		90 6.24 x 0.02 lb

\*S designates remote indicator

## Specifications

	GP-60K	GP-60KS*	GP-61K	GP-61KS	GP-100K	GP-100KS*	GP-102K	
<b>Part #</b>	<b>97807</b>	<b>102902</b>	<b>102900</b>	<b>102903</b>	<b>97808</b>	<b>97811</b>	<b>97809</b>	
<b>List Price</b>	<b>\$4,955.00</b>	<b>\$5,195.00</b>	<b>\$5,395.00</b>	<b>\$5,525.00</b>	<b>\$5,345.00</b>	<b>\$5,655.00</b>	<b>\$4,795.00</b>	
Capacity	61 kg		61 kg		100 kg	101 kg	101 kg/61 kg	
<b>Resolution</b>	<b>1 g</b>		<b>0.1 g</b>		<b>1 g</b>		<b>10/1 g</b>	
Operating Modes	counting, percentage							
Repeatability	0.7 g	-	0.2 g	-	1 g	-	(5/1) g	
Linearity	±1 g	-	±0.5 g	-	±2 g	-	±10 / ±2 g	
Sensitivity Drift (-10 to +30 ° C)	±6 ppm/° C						±10 ppm/° C	
Stabilization Time	Approx. 1.5 seconds (typical in FAST mode)							
Operating Temperature	41°F to 104°F (5°C to 40°C) RH less than 85% (No condensation)							
<b>Pan Size</b>	<b>Stainless steel 15 x 13 in (384 x 344 mm)</b>			-	<b>Stainless steel 15 x 13 in (386 x 346 mm)</b>			
Dimensions	14.6 W x 24.2 D x 5.1 in H (372 x 615 x 130 mm)							
Height with Column	25.7 in (652 mm)							
Weight	Approx 37.4 lb (17 kg)				Approx 39.7 lb (18 kg)			
External Cal Mass	30/40/50/60 kg		20/30/40/50/60 kg		60/80/100 kg			
Warranty	Five-year limited warranty							
Return Policy	A&D Weighing Standard Policy - restock fee may apply							
<b>UNIT OF MEASURE</b>	Decimal Ounces	2151.7 x 0.05 oz		2151.7 x 0.005 oz		3562.65 x 0.05 oz		3562.5/2151.7 x 0.5/0.05 oz
	Troy Ounce	1961.2 x 0.05 ozt		1961.2 x 0.005 ozt		3247.25 x 0.05 ozt		3247/1961.2 x 0.5/0.05 ozt
	Pennyweight	39224 x 1 dwt		39224 x 0.1 dwt		-		-
	Carat	305000 x 5 ct		305000 x 0.5 ct		-		-
	Momme	16266.5 x 0.5 mom		16266.5 x 0.05 mom		26933.5 x 0.5 mom		26935/16266.5 x 5/0.5 mom
	Pound	134.480 x 0.005 lb		134.480 x 0.0005 lb		222.665 x 0.005 lb		222.65/134.48 x 0.05/0.005 lb
	Pound/Ounce	134 7.7 x .01 lb		134 7.7 x .001 lb		222 10.7 x 0.1 lb		222 11/134 7.7 x 0/0.1 lb

\*S designates remote indicator

## Part Number/Price

PART #	MODEL #	DESCRIPTION	PRICE
97802	GP-12K	12 kg x 0.1 g	\$3,395.00
97803	GP-20K	21 kg x 0.1 g	3,725.00
97805	GP-30K	31 kg x 0.1 g	4,445.00
97810	GP-30KS	31 kg x 0.1 g	4,685.00
97804	GP-32K	31/6 kg x 1/0.1 g	3,025.00
102901	GP-32KS	31/6 kg x 1/0.1 g	3,375.00
97806	GP-40K	41 kg x 0.5 g	4,025.00
97807	GP-60K	61 kg x 1 g	4,955.00
102902	GP-60KS	61 kg x 1 g	5,195.00
102900	GP-61K	61 kg x 0.1 g	5,395.00
102903	GP-61KS	61 kg x 0.1 g	5,525.00
97808	GP-100K	100 kg x 1 g	5,345.00
97811	GP-100KS	101 kg x 1 g	5,655.00
97809	GP-102K	101/61 kg x 10/1 g	4,795.00

## Options/Accessories

PART #	A&D MODEL #	DESCRIPTION	PRICE
97607	AD-1682	Rechargeable battery pack	\$658.00
97608	AD-8920	Universal remote display	260.00
97813	GP-04	Comparator output with buzzer	245.00
97814	GP-06	Analog output (replaces standard RS-232C)	811.00
97815	GP-07	GP extension cable (factory installed 120 day lead time)	302.00
97816	GP-20	Underhook GP-12 kg thru 40 kg	173.00
97817	GP-21	Underhook GP-60 kg thru 102 kg	173.00
97818	GP-22	AD-8121B printer support	152.00
97605	AD-100-2	Anti-theft device	70.00
97820	07:3004753	Protective in-use cover	18.00
97613	TB:136	AC adapter (120V) standard with unit	41.00
97614	TB:137	AC adapter (220V)	50.00
97609	AD-8922	Remote controller	615.00
102904	GP-12	Animal weighing pan	1,627.00
151247	AD-1688	Data logger	295.00
97612	SW:128	Foot switch	72.00
158785	AD-8121B	Dot matrix statistical printer	865.00

A & D Weighing  
**MS-70/MX-50/MF-50 Series**  
 Moisture Analyzers

Capacity: 51 g-71 g Readability: 0.001 g-0.0001 g

### Standard Features

- Fast and uniform heating with halogen lamp and uniquely designed (secondary radiation assist) SRA filter
- WinCT® communication tools software
- Sodium tartrate dihydrate is provided as a stable moisture content for accuracy checks of the analyzer
- Five measurement programs: standard, automatic, timer, manual and quick
- Vacuum fluorescent display (VFD)
- Glass window for heating check and easy cleaning
- Self-check function
- Quick reference card
- Standard bidirectional RS-232C
- GLP/ GMP/GCP/ISO compliant with time and date, ID, calibration data and check record outputs



### Specifications

	MS-70	MX-50	MF-50	ML-50
<b>Part#</b>	<b>97821</b>	<b>97822</b>	<b>97823</b>	<b>112408</b>
<b>List Price</b>	<b>\$5,645.00</b>	<b>\$3,525.00</b>	<b>\$2,850.00</b>	<b>\$2,400.00</b>
Capacity	71 g	51 g	51 g	51 g
<b>Resolution</b>	<b>0.0001 g</b>	<b>0.001 g</b>	<b>0.002 g</b>	<b>0.005 g</b>
Moisture Content Display	0.001%/0.01% 0.1%	0.01%/0.1%	0.05%/0.1%/1%	0.1%/1%
Moisture Content Accuracy over 1g	0.05%	0.10%	0.20%	0.50%
Over 5 g	0.01%	0.02%	0.05%	0.10%
Heating Technology	Halogen lamp (straight type, 400 Watt max, 5000 hours)			
Drying Temperature	30° C to 200° C	50° C to 200° C (1° increment)		
Measurement Program Memories	20 sets		10 sets	5 sets
Data Memory	100		50	30
Measurement Programs	Standard/Automatic/Timer/Manual			
Measurement Modes	Wet base/Dry base/Solid content/Ratio			
Operating Temperature	40° F to 104° F (5° C to 40° C)			
<b>Sample Pan Size</b>	<b>Ø 2.16 in (85 mm)</b>			
Dimensions	8.46 W x 12.6 D x 6.8 H in (215 x 320 x 173 mm)			
Weight	13 lb (5.9 kg)			
Power	120VAC			
Warranty	Five-year limited warranty			
Return Policy	A&D Weighing Standard Policy - restock fee may apply			

A & D Weighing

## MS-70/MX-50/MF-50 Series

Moisture Analyzers

BALANCES

### Part Number/Price

PART #	MODEL #	DESCRIPTION	PRICE
97821	MS-70	71 g x 0.0001 g	\$5,645.00
97822	MX-50	51 g x 0.001 g	3,525.00
97823	MF-50	51 g x 0.002 g	2,850.00
112408	ML-50	51 g x 0.005 g	2,400.00

### Options/Accessories

PART #	A&D MODEL #	DESCRIPTION	PRICE
97824	AX-31	Sample pans (washable, 100 each)	\$92.00
97825	AX-32-2	Glass fiber sheets (100 each)	50.00
97826	AX-33	Sodium tartrate dehydrate test samples (30 x 12 g)	80.00
97827	AX-34	Halogen lamp (replacement)	61.00
97828	AX-35	Pan handles (2 each)	26.00
97829	AX-36	Tweezers (2 each)	16.00
97830	AX-37	Spoons (2 each)	20.00
97831	AX-38	Protective in-use covers (5 each)	40.00
97832	AX-39	Dust cover	16.00
97833	AX-42	WinCT® Moisture (standard for MS-70 and MX-50, option for MF-50)	230.00
97834	AD-1700-20G	Calibration mass (20 g)	140.00
97837	AX-43	Temperature calibrator (MS-70 and MX-50 only)	435.00
151247	AD-1688	Data logger	295.00
158785	AD-8121B	Dot matrix statistical printer, includes cable	845.00

www.ricelake.com | Phone: 800-472-6703

RICE LAKE

## Standard Features

- Selectable environmental filters
- RS-232 interface with full GLP/GMP protocol
- Easy to clean stainless steel platform
- Windring and glass and steel construction
- Protective in-use cover
- Integral underweigh hook
- Easy to use keypad
- Up-front level indicator
- Stability indicator
- Mechanical and software overload/underload protection
- User selectable span calibration points
- Auto tare, auto shutoffs
- User selectable printing options
- User selectable communications settings
- User definable project and user IDs
- Software reset menu
- Software lockout menu



## Approvals



## Specifications

	DV114C <sup>^</sup>	DV214C <sup>^</sup>	DV314C <sup>^</sup>	DV215CD <sup>^</sup>
<b>Part Number</b>	<b>96945</b>	<b>96947</b>	<b>96949</b>	<b>96950</b>
<b>List Price</b>	<b>\$4,321.00</b>	<b>\$4,744.00</b>	<b>\$5,365.00</b>	<b>\$6,111.00</b>
Capacity	110 g	210 g	310 g	210/81 g
<b>Resolution</b>	<b>0.1 mg</b>	<b>0.1 mg</b>	<b>0.1 mg</b>	<b>0.1/ 0.01 mg</b>
Weighing Modes	Milligram, Gram, Carat, Ounce, Troy Ounce, Grain, Pennyweight, Momme, Hong Kong Tael, Singapore Tael, Taiwan Tael, Custom			
Operating Modes	Weighing, Counting with automatic sample recalculation, Percent weighing, Checkweighing, animal/dynamic weighing, gross/net/tare weighing, totalization, high point density, statistics, pipette calibration			
Repeatability	0.1 mg		0.2 mg	0.1/0.02 mg
Linearity	0.2 mg	0.5 mg	0.2/0.03 mg	
Stabilization Time	4 seconds		8 seconds	15/5 seconds
Operating Temperature	50° F to 104° F (10° C to 40° C)			
<b>Pan Size</b>	<b>Ø 3.8 in (9 cm)</b>			
Dimensions	7.9 x 11.8 x 18 in (20 x 30 x 45.7 cm)			
Weight (Approx.)	10.2 kg (22.5 lb)			
Calibration	Automatic internal, Push-button Internal, Manual external			
Power	120 V AC adapter (220-240 V AC adapter by special order), 50/60 Hz			
Warranty	Two-year limited warranty			
Return Policy	Ohaus Standard Policy - restock fee may apply			

<sup>^</sup>Weighing Chamber

Ohaus

**Discovery™**

Semi-Micro and Analytical Balances

BALANCES

### Part Number/Price

PART #	MODEL #	DESCRIPTION	PRICE
96945	DV114C	110 g x 0.1 mg	\$4,321.00
96947	DV214C	210 g x 0.1 mg	4,744.00
96949	DV314C	310 g x 0.1 mg	5,365.00
96950	DV215CD	210/81 g x .0.1/0.01 mg	6,111.00

### Options/Accessories

PART #	MODEL #	DESCRIPTION	PRICE
71960	80500571	RS-232 cable, printer	\$132.00
67413	SW12W	TAL software WinWedge	425.00
70406	80500525	RS-232 cable, IBM 9-Pin	132.00
77712	80500524	RS-232 cable, IBM 25-Pin	132.00
67408	77402-00	Density determination kit	1,350.00
67409	77401-00	Security device	165.00
13064	—	100 g calibration mass, ASTM Class 1	85.00
13066	—	200 g calibration mass, ASTM Class 1	105.00
104767	80252042	Dot matrix printer	682.00
104770	80251932	Paper	12.00
104771	80251933	Ink ribbon	35.00
67669	21202537	Power adapter, 220-240	55.00
67667	80500006	UK line cord	25.00

www.ricelake.com | Phone: 800-472-6703

**RICE LAKE**



## Standard Features

- Easy-to-clean analytical draft shield
- Up-front level indicator
- Selectable environment settings
- Flexibility of available options
- Removable doors for easy cleaning and access
- Up-front level bubble for easy reference
- Selectable environmental settings
- Integral underweigh hook
- Standard security bracket
- Standard RS-232C
- Security menu lock
- Multiple application modes and units of measure
- Backlight display



## Approvals



## Specifications

	PA84 <sup>^</sup>	PA124 <sup>^</sup>	PA224 <sup>^</sup>	PA163	PA323	PA523
<b>Part#</b>	<b>167603</b>	<b>167604</b>	<b>167605</b>	<b>167606</b>	<b>167607</b>	<b>167608</b>
<b>List Price</b>	<b>\$1,605.00</b>	<b>\$1,926.00</b>	<b>\$2,140.00</b>	<b>\$963.00</b>	<b>\$1,124.00</b>	<b>\$1,338.00</b>
Capacity (g)	85	120	220	160	320	520
<b>Resolution (g)</b>	<b>0.1 mg</b>	<b>0.1 mg</b>	<b>0.1 mg</b>	<b>0.001</b>	<b>0.001</b>	<b>0.001</b>
Weighing Modes	Milligram, Gram, Carat, Ounce, Troy Ounce, Grain, Pennyweight, Momme, Taels, tical, tola, baht, mesghal, Newton, custom unit					
Operating Modes	Weighing, Parts Counting, Percent, Density Determination, Dynamic Weighing					
Repeatability (mg)	0.1				1	
Linearity (mg)	0.2		0.3		2	
Stabilization Time	Three seconds					
Operating Temperature	50°F to 104°F (10°C to 40°C)					
<b>Pan Size</b>	<b>3.54 in (90 mm)</b>			<b>4.72 in (120 mm)</b>		
Dimensions	7.7 x 11.3 x 12.6 in ( 19,6 x 28,7 x 32 cm)					
Weight (Approx.)	10 lb (4,5 kg)					
Calibration Weight (g)	50/80	50/100	100/200	100/150	200/300	200/500
Power	120 VAC adapter (220-240 VAC adapter by special order) , 50/60 Hz					
Warranty	Two-year limited warranty					
Return Policy	Ohaus Standard Policy - restock fee may apply					

<sup>^</sup>Weighing Chamber

## Specifications

	PA1602	PA2202	PA3202	PA4202	PA2201	PA4201
<b>Part#</b>	<b>167609</b>	<b>167610</b>	<b>167611</b>	<b>167612</b>	<b>167613</b>	<b>167614</b>
<b>List Price</b>	<b>\$866.00</b>	<b>\$1,017.00</b>	<b>\$1,231.00</b>	<b>\$1,391.00</b>	<b>\$910.00</b>	<b>\$1,070.00</b>
Capacity (g)	1600	2200	3200	4200	2200	4200
<b>Resolution (g)</b>	<b>0.01</b>	<b>0.01</b>	<b>0.01</b>	<b>0.01</b>	<b>0.1</b>	<b>0.1</b>
Weighing Modes	Milligram, Gram, Carat, Ounce, Troy Ounce, Grain, Pennyweight, Momme, Taels, tical, tola, baht, mesghal, Newton, custom unit					
Operating Modes	Weighing, Parts Counting, Percent, Density Determination, Dynamic Weighing					
Repeatability (mg)	10			100		
Linearity (mg)	20			100		
Stabilization Time	Three seconds					
Operating Temperature	50°F to 104°F (10°C to 40°C)					
<b>Pan Size</b>	<b>7.1 in (180 mm)</b>					
Dimensions	7.7 x 11.3 x 12.6 in ( 19,6 x 28,7 x 32 cm)					
Weight (Approx.)	3.3 kg (7.3 lb)					
Calibration Weight (g)	1000/1500	1000/2000	2000/3000	2000/4000	1000/2000	2000/4000
Power	120 VAC adapter (220-240 VAC adapter by special order) , 50/60 Hz					
Warranty	Two-year limited warranty					
Return Policy	Ohaus Standard Policy - restock fee may apply					

Ohaus

**Pioneer™**

Analytical/Precision Balances

BALANCES

### Part Number/Price

PART #	MODEL #	DESCRIPTION	PRICE
167603	PA84	85 g x 0.1 mg	\$1,605.00
167604	PA124	120 g x 0.1 mg	1,926.00
167605	PA224	220 g x 0.1 mg	2,140.00
167606	PA163	160 g x 0.001 g	963.00
167607	PA323	320 g x 0.001 g	1,124.00
167608	PA523	520 g x 0.001 g	1,338.00
167609	PA1602	1600 g x 0.01 g	866.00
167610	PA2202	2200 g x 0.01 g	1,017.00
167611	PA3202	3200 g x 0.01 g	1,231.00
167612	PA4202	4200 g x 0.01 g	1,391.00
167613	PA2201	2200 g x 0.1 g	910.00
167614	PA4202	4200 g x 0.1 g	1,070.00

### Options/Accessories

PART #	MODEL #	DESCRIPTION	PRICE
104767	80252042	Compact impact printer, 42 column	\$682.00
67413	SW12W	TAL software WinWedge®	425.00
104770	80251932	Paper for printer	12.00
104771	80251933	Ribbon for printer	35.00
71960	80500571	RS-232 cable, printer to Pioneer	132.00
70406	80500525	RS-232 cable, PC 9-Pin to Pioneer	132.00
77712	80500524	RS-232 cable, PC 25-Pin to Pioneer	132.00
102798	80850045	Density determination kit for Pioneer analytical balances (0.1 mg and 1 mg)	533.00
35263	76288-01	Security device for Pioneer	158.00
102799	128-00	Forceps, 2.75 in (70 mm)	17.00
102800	129-00	Forceps, 3.5 in (89 mm)	17.00
33455	5076-00	Aluminum scoop, 1.5 in x 2 in (3.8 cm x 5.1 cm), weight 4 g	25.00
33456	5077-00	Gold scoop, 2.25 in x 3 in (5.7 cm x 7.6 cm), weight 10 g	25.00
33454	4590-30	Black scoop, aluminum 4 in x 3.5 in (10.2 cm x 8.9 cm), weight 24 g	26.00
33451	3369-10	Polypropylene Maxi-Scoop™ 10 in dia. x 2.5 in deep (25.4 cm dia. x 6.4 cm deep) with pouring spout, weight 145 g	35.00
102801	71147059	Plastic scoop, 1.3 in x 1.5 in x 0.4 in (33 mm x 38 mm x 10 mm) deep with pouring spout, weight 1.2 g	19.00
97250	80250400	Stainless steel scoop 11.9 in x 7.38 in x 1.69 in	50.00
100292	80250954	Stainless steel scoop 17.2 in x 11 in x 3.4 in (44 cm x 28 cm x 8.5 cm)	62.00

www.ricelake.com | Phone: 800-472-6703

**RICE LAKE**

## Standard Features

- Automatic calibration via AutoCal™
- Communication RS-232C
- On screen prompts
- Spill channel
- Applications library to store and quickly recall past procedures
- Brilliant backlit high resolution dot matrix display with simple navigation windows and menus to guide you through balance functions
- User selectable GLP outputs via RS-232 to meet traceability requirements
- User selectable filter, stability indicator and auto-zero tracking for use in difficult environments
- Five-language operation display text
- Standard underweigh capability
- Protective in-use cover and security bracket
- Optional Features
- Autocal™ automatic calibration
- NTEP Certified, Legal for Trade models by special order



## Specifications

MODEL	EX124 <sup>^</sup>	EX224 <sup>^*</sup>	EX324 <sup>^*</sup>
Part Number	121192	121193	121194
List Price	\$3,967.00	\$4,505.00	\$5,120.00
Capacity	120 g	220 g	320 g
Resolution	0.0001 g		
Weighing Units	Gram, Milligram, Kilogram, Carat, Ounce, Ounce Troy, Pennyweight, Grain, Newton, Momme, Mesghal, Hong Kong Tael, Singapore Tael, Taiwan Tael, Tical, Tola, Baht, 3 Custom Units		
Operating Modes	Weighing, Percent Weighing, Parts Counting, Check Weighing, Dynamic/Animal Weighing, Filling, Totalization, Formulation, Differential Weighing, Density Determination, Peak Hold, Ingredient Costing, Pipette Adjustment, SQC		
Repeatability	±0.0001 g		
Linearity	±0.0002 g		
Stabilization Time	≤2 seconds		≤3 seconds
Operating Temperature Range	50° F to 86° F (10° C to 30° C)		
Weighing Chamber	9.5 x 7.5 x 6.5 in (241.3 x 190.5 x 165.1 mm)		
Pan Size	Ø 3.5 in (90 mm)		
Display Housing Dimensions	7.7 x 3.5 x 6.0 in (195 x 90 x 154 mm)		
Dimensions Base	9.1 x 13.8 x 15.5 in (230 x 350 x 393 mm)		
Shipping Weight	21.1 lb (9.6 kg)		
Calibration	AutoCal™ on Δ1.5° C temperature change, 11 hours, and external calibration		
Power Requirements	AC adapter input: 100-240 VAC 0.6A 50-60 Hz		
Warranty	Two-year limited warranty		
Return Policy	Ohaus Standard Policy - restock fee may apply		

<sup>^</sup>Weighing Chamber

<sup>\*</sup>NTEP and Measurement Canada models available by special order

### Part Number/Price

PART #	MODEL #	DESCRIPTION	PRICE
121192	EX124	120 g x 0.0001 g	\$3,967.00
121193	EX224	220 g x 0.0001 g	4,505.00
121194	EX324	320 g x 0.0001 g	5,120.00

### Options/Accessories

PART #	MODEL #	DESCRIPTION	PRICE
67422	80253384	Density determination kit	\$533.00
35263	76288-01	Security device for EX	158.00
104767	80252042	Compact dot matrix impact printer	682.00
77712	80500524	RS-232 cable, PC 25-Pin to EX	132.00
70406	80500525	RS-232 Cable, PC 9-Pin to EX	132.00

## Standard Features

- Capacities from 220 g to 10.2 kg with Readability to 0.001 g
- Large 5.7 in full-color touchscreen display with intuitive set-up and application software
- AutoCal™ automatic internal calibration for optimized weighing performance
- 14 application modes, 11 weighing units and 5 display languages for a wide variety of applications
- 4 programmable touchless sensors for hands-free operation
- 0.001 g models feature frameless draftshield with anti-static glass, flip-top and large side entry doors on top-mounted bearings



## Optional Features

- External calibration models

## Specifications

MODEL	EX223 <sup>^</sup>	EX423 <sup>^*</sup>	EX623 <sup>^</sup>	EX1103 <sup>^*</sup>	EX2202	EX4202 <sup>*</sup>	EX6202	EX10202 <sup>*</sup>	EX6201	EX10201 <sup>*</sup>
Part Number	121195	121196	121197	121198	121199	121200	121201	121202	121203	121204
List Price	\$3,116.00	\$3,393.00	\$3,706.00	\$4,485.00	\$3,127.00	\$3,393.00	\$3,711.00	\$4,505.00	\$3,178.00	\$3,414.00
Capacity	220 g	420 g	620 g	1100 g	2200 g	4200 g	6200 g	10200 g	6200 g	10200 g
Resolution	0.001 g				0.01 g				0.1 g	
Weighing Units	Gram, Milligram, Kilogram, Carat, Ounce Troy, Pound, Pennyweight, Grain, Newton, Momme, Mesghal, Hong Kong Tael, Singapore Tael, Taiwan Tael, Tical, Tola, Baht, 3 Custom Units									
Operating Modes	Weighing, Percent Weighing, Parts Counting, Check Weighing, Dynamic/Animal Weighing, Filling, Totalization, Formulation, Differential Weighing, Density Determination, Peak Hold, Ingredient Costing, Pipette Adjustment, SQC									
Repeatability	±0.001 g				±0.01 g				±0.1 g	
Linearity	±0.002 g				±0.02 g				±0.1 g	
Stabilization Time	≤1.5 seconds					≤1 seconds				
Operating Temperature Range	50° F to 86° F (10° C to 30° C)									
Weighing Chamber	9.5 x 7.5 x 6.5 in				N/A					
Pan Size	Ø 5.1 in (130 mm)				7.5 x 7.9 in (190 x 200 mm)					
Display Housing Dimensions	7.7 x 3.5 x 6.0 in (195 x 90 x 154 mm)									
Dimensions Base	9.1 x 13.8 x 15.5 in (230 x 350 x 393 mm)					9.1 x 3.9 x 15.5 in (230 x 98 x 393 mm)				
Shipping Weight	21.1 lb (9.6 kg)				15 lb (6.8 kg)			16.3 lb (7.4 kg)		
Calibration	AutoCal™ on Δ1.5° C temperature change, 11 hours, and external calibration									
Power Requirements	AC adapter input: 100-240 VAC 0.6A 50-60 Hz									
Warranty	Two-year limited warranty									
Return Policy	Ohaus Standard Policy - restock fee may apply									

<sup>^</sup>Weighing Chamber

<sup>\*</sup>NTEP models available by special request

## Part Number/Price

PART #	MODEL #	DESCRIPTION	PRICE
121195	EX223^	220 g x 0.001 g	\$3,116.00
121196	EX423^	420 g x 0.001 g	3,393.00
121197	EX623^	620 g x 0.001 g	3,706.00
121198	EX1103^	1100 g x 0.001 g	4,485.00
121199	EX2202	2200 g x 0.01 g	3,127.00
121200	EX4202	4200 g x 0.01 g	3,393.00
121201	EX6202	6200 g x 0.01 g	3,711.00
121202	EX10202	10200 g x 0.01 g	4,505.00
121203	EX6201	6200 g x 0.1 g	3,178.00
121204	EX10201	10200 g x 0.1 g	3,414.00

^Weighing Chamber

## Options/Accessories

PART #	MODEL #	DESCRIPTION	PRICE
67422	80253384	Density Determination Kit (for 410 g capacity and below)	\$533.00
35263	76288-01	Security Device for EX	158.00
104767	80252042	Compact Dot Matrix Impact Printer	682.00
77712	80500524	RS-232 Cable, PC 25-Pin to EX	132.00
70406	80500525	RS-232 Cable, PC 9-Pin to EX	132.00
67669	21202537	Power adapter, 220-240	55.00
67667	80500006	UK line cord	25.00

## Standard Features

- Touchless IR (infrared) sensors minimize keypad use
- Program IR sensor to control operations including print, tare, and other selectable functions
- Color VGA 5.7 in display with icons for simple menu navigation
- Multiple application modes designed for versatility
- AutoCal Calibration
- Robust IP 54 die-cast metal bottom housing with stainless steel pan
- Integral weigh below hook
- ENERGY STAR qualified adapter



## Specifications

	EX12001	EX22001	EX32001
<b>Part#</b>	<b>157235</b>	<b>157236</b>	<b>157237</b>
<b>List Price</b>	<b>\$3,625.00</b>	<b>\$4,453.00</b>	<b>\$5,280.00</b>
Capacity	12000 g	24000 g	35000 g
<b>Resolution</b>	<b>0.1 g</b>		
Weighing Modes	Gram, Kilogram, Carat, Ounce, Troy Ounce, Pound,, Pennyweight, Mommies, Grain, Tical, Tola, Newton, Mesghal, 3 Custom Units		
Operating Modes	Weighing, Counting, Animal/Dynamic weighing, Checkweighing, Percent weighing, Filling, Parts Counting, Totalization, Formulation, Differential Weighing, Density Determination, Peak Hold, Ingredient Costing, SQC		
Repeatability	±0.1 g		
Linearity	±0.2 g		
Stabilization Time	≤1		
Operating Temperature	14° F to 140° F (-10° C to 60° C)		
<b>Pan Size</b>	<b>14.84 x 12.24 in (377 x 311 mm)</b>		
Display Housing Dimensions	7.7 W x 3.5 H x 6.0 in D (195 W x 90 H x 154 mm D)		
Dimensions Base	14.84 x 4.72 x 17.44 in (377 x 120 x 443 mm)		
Weight (Approx.)	25 lb 12.5 kg		
Calibration	Auto Cal internal calibration		
Power	AC adapter input: 100-240VAC 0.6A 50-60Hz		
Warranty	Two-year limited warranty		
Return Policy	Ohaus Standard Policy - restock fee may apply		

Ohaus  
**Explorer® Pro**  
High Capacity

BALANCES

### Part Number/Price

PART #	MODEL #	DESCRIPTION	PRICE
157235	EX12001	12000 g x 0.1 g	\$3,625.00
157236	EX24001	24000 g x 0.1 g	4,453.00
157237	EX35001	35000 g x 0.1 g	5,280.00

### Options/Accessories

PART #	MODEL #	DESCRIPTION	PRICE
157238	30078082	Tower mount display	\$104.00
104767	80252042	Compact dot matrix impact printer	682.00
77712	80500524	RS-232 cable, PC 25-Pin to EX	132.00
70406	80500525	RS-232 cable, PC 9-Pin to EX	132.00

www.ricelake.com | Phone: 800-472-6703

**RICE LAKE**



Ohaus

# Adventurer Pro®

Precision Balances

Capacity: 120g-8200g Readability: 0.0001g-0.1g

## Standard Features

- Stability, Accuracy and Fast operation ensuring optimal weighing results
- Color touchscreen with 4.3 in (109 mm) display size
- Dual USB ports and RS232 provide connectivity options
- Space-saving top-mounted draft shield on analytical models
- Real time clock with GLP/GMP data
- Below minimum sample weight indication with minimum weight feature



## APPROVALS



Measurement  
Canada  
Approved

## Specifications

	AX124 ^	AX224 ^	AX324^	AX223^	AX423^	AX523^	AX622	AX1502
Part Number	164622	164623	164625	164626	164628	164630	164633	164635
List Price	Consult	Consult	Consult	Consult	Consult	Consult	Consult	Consult
<b>NTEP</b> Part Number	N/A	164624	N/A	164627	164629	164632	164634	164636
<b>NTEP</b> List Price	N/A	Consult	N/A	Consult	Consult	Consult	Consult	Consult
Capacity (g)	120 g	220 g	320 g	220 g	420 g	520 g	620 g	1520 g
Resolution (g)	0.0001 g	0.0001 g	0.0001 g	0.001 g	0.001 g	0.001 g	0.01 g	0.01 g
NTEP Class		I (0.001 g)		II (0.01 g)	II (0.01 g)	II (0.01g)	II (0.1g)	
Weighing Modes	Milligram, Gram, Kilogram, Ounce, Pound, Carat, Pennyweight, Troy Ounce, Grain, Newton, Hong Kong tael, Singapore tael, Taiwan tael, Momme, tical, baht, mesgal, tola, custom							
Operating Modes	Counting, Weighing, Dynamic weighing, Checkweighing, Percent Weighing, Totalization, Display hold, Density Determination, Formulation							
Repeatability	1 mg			0.001 g				
Linearity	0.2 mg				0.002			
Operating Temperature	10 to 30° C (50 to 86° F)							
Pan Size	90 mm (3.5in)			130 mm (5.1 in)			175 x 195 mm(6.9 x 7.7 in)	
Dimensions Base Housing	13.93 x 13.39 x 9.05 in (354 x 340 x 230 mm )						13.93 x 3.94 x 9.05 in (354 x 100 x 230 mm )	
Weight (Approx.)	17.2 lb (7.8 kg)			12.8 lb (5.8 kg)			14.4 lb (6.5 kg)	
Calibration Weight (g)	100	200	300	200	400	500	600	1500
Power	100 - 240 VAC, 0.3A, 50-60 HZ AC adapter							
Warranty	Two-year limited warranty							

\* NTEP models have reduced resolution

^Weighing Chamber

## Specifications

	AX2202	AX4202	AX5202	AX4201	AX8201
Part Number	164637	164639	164641	164642	164643
List Price	Consult	Consult	Consult	Consult	Consult
NTEP	Part Number	164638	164640	N/A	164644
	List Price	Consult	Consult	N/A	Consult
Capacity (g)	2200 g	4200 g	5200 g	4200 g	8200 g
Resolution (g)	0.01 g	0.01 g	0.01 g	0.1 g	0.1 g
NTEP Class	II (0.1 g)	II (0.1g)			II (1 g)
Weighing Modes	gram, Gram, Kilogram, Ounce, Pound, Carat, Pennyweight, Troy Ounce, Grain, Newton, Hong Kong tael, Singapore tael, Taiwan tael, Momme, tical, baht, mesgal, tola, custom				
Operating Modes	ing, Weighing, Dynamic weighing, Checkweighing, Percent Weighing, Totalization, Display hold, Density Determination, Formulation				
Repeatability	0.01 g				
Linearity	0.002				
Operating Temperature	10° C to 30° C (50° F to 86° F)				
Pan Size	175 x 195 mm (6.9 x 7.7 in)				
Dimensions Base Housing	13.93 x 3.94 x 9.05 in (354 x 100 x 230 mm )				
Weight (Approx.)	14.4 lb (6.5 kg)				12.6 lb (5.7 kg)
Calibration Weight (g)	2000	4000	5000	4000	8000
Power	100-240 VAC, 0.3A, 50-60 HZ AC adapter				
Warranty	Two-year limited warranty				

\* NTEP models have reduced resolution

^Weighing Chamber

## Part Number/Price

PART #	MODEL #	DESCRIPTION	PRICE
164622	AX124	120 g x 0.0001 g	Consult
164623	AX224	220 g x 0.0001 g	Consult
164624	AX224 N	220 g x 0.001 g	Consult
164625	AX324	320 g x 0.0001 g	Consult
164626	AX223	320 g x 0.001 g	Consult
164627	AX223 N/E	220 g x 0.001 g	Consult
164628	AX423	420 g x 0.001 g	Consult
164629	AX423 N/E	420 g x 0.01 g	Consult
164630	AX523	520 g x 0.001 g	Consult
164632	AX523 N/E	520 g x 0.01 g	Consult
164633	AX622	620 g 0.001 g	Consult
164634	AX622 N/E	620 g x 0.01 g	Consult
164635	AX1502	1520 g x 0.01 g	Consult
164636	AX1502 N/E	1520 g x 0.1 g	Consult
164637	AX2202	2200 g x 0.01 g	Consult
164638	AX2202 N/E	2200 g x 0.1 g	Consult
164639	AX4202	4200 g 0.01 g	Consult
164640	AX4202 N/E	4200 g x 0.1 g	Consult
164641	AX5202	5200 g x 0.01 g	Consult
164642	AX4201	4200 g x 0.1 g	Consult
164643	AX8201	8200 g x 0.1 g	Consult
164644	AX8201 N/E	8200 g x 1 g	Consult

## Options/Accessories

PART #	MODEL #	DESCRIPTION	PRICE
67422	80253384	Density Determination Kit	Consult
156809		USB cable, Type A to B	Consult
67423	80850043	Security Device (Laptop Lock)	Consult
77712	80500524	25-Pin RS232 cable (PC)	Consult
70406	80500525	9-Pin RS232 cable (PC)	Consult

## Standard Features

- Fast halogen heating element provides uniform infrared heating and durability for extended use
- Superior weighing performance with readability up to 0.001 g, 0.01% moisture
- Powerful software for simple operation
- Large backlit 128 x 64 pixel Liquid Crystal Display (LCD) for easy viewing
- GLP/GMP compliant format when printed results are required
- RS-232 port for easy communication with printer or computer
- Multi-language display text (English, Spanish, French)



MB45

## Approvals



## Specifications

	MB23	MB25	MB35	MB45
<b>Part#</b>	<b>109522</b>	<b>109521</b>	<b>70858</b>	<b>70390</b>
<b>List Price</b>	<b>\$2,754.00</b>	<b>\$3,284.00</b>	<b>\$3,824.00</b>	<b>\$4,365.00</b>
Capacity	110 g	110 g	35 g	45 g
<b>Resolution</b>	<b>0.01 g</b>	<b>0.005 g</b>	<b>0.002 g</b>	<b>0.001 g</b>
Repeatability	3 g sample-0.3%; 10 g sample-0.1%	3 g sample-0.2%; 10 g sample-0.05%	3 g sample-0.18%; 10 g sample-0.05%	3 g sample-0.05%; 10 g sample-0.015%
Moisture Range	0.1 - 100%	0.05 - 100%	0.05 to 100%	0.01 to 100% (0.01% to 100% for regain mode)
Heater Type	Infrared (no glass)	Halogen		
Timer	1-99 minutes, 30 second increments to 60 min		1-120 min in 30second -60min increments, 1 min increments from 60-120 min	1-120 min in 10 second increments
Temperature Settings	50° C to 160° C x 5° C (increments)			50° C-200° C x 1° C (increments)
Operating Temperature	41° F to 104° F (5° C to 40° C)		50° F to 104° F (10° C to 40° C)	
<b>Pan Size</b>	<b>Ø 9 cm (3.5in)</b>			
Dimensions	7.5 x 6.0 x 14 in (165 x 127 x 279 mm)		7.5 x 6 x 14 in (190.5 x 152.4 x 355.6 mm)	
Est. Ship Weight	14 lb (6.3 kg)			
Power	120V AC Adapter			
Warranty	Two-year limited warranty			
Return Policy	Ohaus Standard Policy - restock fee may apply			

Ohaus

## MB Series

Moisture Balance

BALANCES

### Part Number/Price

PART #	MODEL #	DESCRIPTION	PRICE
109522	MB23	110 g x 0.01 g (0.1% IR)	\$2,754.00
109521	MB25	100 g x 0.005 g (0.05% Halogen Heat)	3,284.00
70858	MB35	35 g x 0.002 g (0.05% Halogen Heat)	3,824.00
70390	MB45	45 g x 0.001 g (0.01% Halogen Heat)	4,365.00

### Options/Accessories

PART #	MODEL #	DESCRIPTION	PRICE
70401	11113857	Temperature calibration kit	\$387.80
70402	80850087	Pads, glass fiber, 200/box	70.00
70403	80850086	Sample pans, 50/box, 90 mm diameter	42.00
70404	80850088	Reusable sample pans, 3/box	141.00
70405	80850085	In-use cover	54.00
70406	80500525	Cable, 9-Pin serial extension	132.00
67423	470004-010	Security device	158.00
67413	SW12W	WinWedge® TAL Software	425.00
70860	11113873	Sample pan handler (MB-35 only)	95.00
104767	—	Impact printer	682.00
71960	80500571	Cable for PN 104767	132.00
104770	—	Paper for PN 104767	12.00
104771	—	Ribbon for PN 104767	35.00

www.ricelake.com | Phone: 800-472-6703

RICE LAKE

## Standard Features

- Large stainless steel weighing surface
- Large 0.6 in (15.24 mm) high contrast Liquid Crystal Display (LCD)
- Integral security bracket
- Underweigh function (includes hook)
- Sealed front panel and molded spill ring
- Stability indicator
- Overload and underload indicators
- Auto shut-off (user enabled/disabled)
- Low-battery indicator
- Battery or AC operation (AC adapter included)
- Span calibration mass (included on SP202, SP402, SP401, SP601 models)
- Integral shipping lock
- Parameter lock switch



## Specifications

	SP202	SP402	SP602	SP401	SP601	
<b>Part #</b>	<b>77654</b>	<b>77655</b>	<b>103099</b>	<b>77656</b>	<b>77657</b>	
<b>List Price</b>	<b>\$428.00</b>	<b>\$600.00</b>	<b>\$702.00</b>	<b>\$236.00</b>	<b>\$349.00</b>	
Capacity	200 g	400 g	600 g	400 g	600 g	
<b>Resolution</b>	<b>0.01 g</b>	<b>0.01 g</b>	<b>0.01 g</b>	<b>0.1 g</b>	<b>0.1 g</b>	
Operating Modes	Parts Counting with Average Piece Weigh Recalculation, Percentage Weighing, Totalization, Display Hold					
Repeatability	0.01 g			0.1 g		
Linearity	±0.01		±0.02		±0.1	
Stabilization Time	3 seconds					
Operating Temperature	50° F to 104° F (10° C to 40° C)					
<b>Pan Size</b>	<b>Ø 4.7 in (12 cm)</b>				<b>6.5 x 5.5 in (16.5 x 14.2 cm)</b>	
Dimensions	7.56 x 2.13 x 8.27 in (19.2 x 5.4 x 21.0 cm)					
Weight (Approx.)	1.5 lb (0.7 kt)	1.8 lb (0.8 kg)				
Est. Ship Weight	4 lb (1.8 kg)					
Calibration Weight	200 g	400 g	600 g	400 g	600 g	
Power	120V AC Adapter (included) or 4 "AA" Batteries (not included)					
Warranty	Two-year limited warranty					
Return Policy	Ohaus Standard Policy - restock fee may apply					
<b>UNIT OF MEASURE</b>	Ounces	7.0550 x 0.0005 oz	14.1095 x 0.0005 oz	21.645 x 0.0005 oz	14.110 x 0.005 oz	21.165 x 0.005 oz
	Pounds	-	-	1.32280 x 0.00005 lb	-	1.3230 x 0.0005 lb
	Pound, Ounce	-	-	1 lb:5.165 oz x 0.001 oz	-	1 lb:5.165 oz x 0.01 oz
	Troy Ounces	6.4300 x 0.0005 ozt	12.8605 x 0.0005 ozt	19.2905 x 0.0005 ozt	12.860 x 0.005 ozt	19.290 x 0.005 ozt
	Pennyweight	128.60 x 0.01 dwt	257.21 x 0.01 dwt	385.81 x 0.01 dwt	257.2 x 0.1 dwt	385.8 x 0.1 dwt

## Specifications

	SP2001	SP4001	SP6001	SP6000	
<b>Part#</b>	<b>77658</b>	<b>77660</b>	<b>103100</b>	<b>77661</b>	
<b>List Price</b>	<b>\$441.00</b>	<b>\$646.00</b>	<b>\$728.00</b>	<b>\$366.00</b>	
Capacity	2000 g	4000 g	6000 g	6000 g	
<b>Resolution</b>	<b>0.1 g</b>	<b>0.1 g</b>	<b>0.1 g</b>	<b>1 g</b>	
Operating Modes	Parts Counting with Average Piece Weigh Recalculation, Percentage Weighing, Totalization, Display Hold				
Repeatability	0.1 g			1 g	
Linearity	±0.1		±0.2	±0.1	
Stabilization Time	3 seconds				
Operating Temperature	50° F to 104° F (10° C to 40° C)				
<b>Pan Size</b>	<b>6.5 x 5.5 in (16.5 x 14.2 cm)</b>				
Dimensions	7.56 x 2.13 x 8.27 in (19.2 x 5.4 x 21.0 cm)				
Weight (Approx.)	1.8 lb (0.8 kg)				
Est. Ship Weight	4 lb (1.8 kg)				
Calibration Weight	2000 g	4000 g	6000 g	6000 g	
Power	120V AC Adapter (included) or 4 AA Batteries (not included)				
Warranty	Two-year limited warranty				
Return Policy	Ohaus Standard Policy - restock fee may apply				
<b>UNIT OF MEASURE</b>	Kilogram	2.0000 x 0.0001 kg	4.0000 x 0.0001 kg	6.0000 x 0.0001 kg	6.000 x 0.001 kg
	Ounces	70.550 x 0.005 oz	141.095 x 0.005 oz	211.645 x 0.005 oz	211.65 x 0.05 oz
	Pounds	4.4090 x 0.0005 lb	8.8185 x 0.0005 lb	13.2280 x 0.0005 lb	13.230 x 0.005 lb
	Pound, Ounce	4 lb:6.550 oz x 0.01 oz	8 lb:13.095 oz x 0.01 oz	13 lb:3.65 oz x 0.01 oz	13 lb:3.65 oz x 0.05 oz
	Troy Ounces	64.300 x 0.005 ozt	128.605 x 0.005 ozt	192.905 x 0.005 ozt	192.90 x 0.05 ozt
	Pennyweight	1286 x 0.1 dwt	2572.1 x 0.1 dwt	3858.1 x 0.1 dwt	3858 x 1 dwt

## Part Number/Price

PART #	MODEL #	DESCRIPTION	PRICE
77654	SP202	200 g x 0.01 g	\$428.00
77655	SP402	400 g x 0.01 g	600.00
103099	SP602	600 g x 0.01 g	702.00
77656	SP401	400 g x 0.1 g	236.00
77657	SP601	600 g x 0.1 g	349.00
77658	SP2001	2000 g x 0.1 g	441.00
77660	SP4001	4000 g x 0.1 g	646.00
103100	SP6001	6000 g x 0.1 g	728.00
77661	SP6000	6000 g x 1 g	366.00

## Options/Accessories

PART #	MODEL #	DESCRIPTION	PRICE
70422	77256-01	Hard shell carrying case	\$100.00
77710	71147376	RS-232 interface with integrated cable, DB9	132.00
118780	71147377	USB interface with integrated cable	132.00
35263	76288-01	Security device	158.00
67413	SW12W	WinWedge® TAL Software	425.00
104767	—	Impact printer	682.00
104770	—	Paper for PN 104767	12.00
104771	—	Ribbon for PN 104767	35.00
92804	71168909	In-use cover, set of three	37.00
156234	46001724	110/220V AC power supply (requires PN 156235)	37.00
156235	46001780	Plug set	15.00

## Standard Features

- Superior RF protection
- Reliable, stable results
- CE listed and FCC Class B Part 15 operation
- Large removable stainless steel weighing platform
- Low profile design
- Standard AC adapter
- Easy operation
- Low-battery indicator
- Auto shut-off feature
- Overload protection
- Push-button calibration



## Specifications

	CS200	CS2000	CS5000	CS2000P*	CS5000P*	CS200P*
<b>Part#</b>	53493	53494	53495	53496	53497	83225
<b>List Price</b>	\$132.00	\$132.00	\$155.00	\$142.00	\$169.00	\$142.00
Capacity	200 g	2000 g	5000 g	2000 g	5000 g	200 g
<b>Resolution</b>	<b>0.1 g</b>	<b>1 g</b>	<b>1 g</b>	<b>1 g</b>	<b>1 g</b>	<b>0.1 g</b>
Weighing Modes	g, lb:oz, Newton			4 lb:6.55 oz x 0.05 oz	11 lb:0.4 oz x 0.1 oz	0 lb:7 oz x 0.01 oz
Repeatability	0.1 g	1 g	1 g	1 g	1 g	0.1 g
Linearity	±0.1 g	±1 g	±1 g	±1 g	±1 g	±0.1 g
Stabilization Time	3 seconds					
Operating Temperature	64° to 77° F (18° to 25° C)					
<b>Pan Size</b>	<b>5.75 x 5.25 in (14.5 x 13.3 cm)</b>					
Dimensions	8.0 x 5.5 x 1.5 in (20.3 x 14.0 x 3.8 cm)					
Weight (Approx.)	0.91 lb (.47 kg)					
Power	3 "AA" alkaline batteries (included) or AC adapter (included)					
Battery Life	300 hours					
Warranty	One-year limited warranty					
Return Policy	Ohaus Standard Policy - restock fee may apply					

\*Includes US postal chart

## Part Number/Price

PART #	MODEL #	DESCRIPTION	PRICE
53493	CS200	200 g x 0.1 g	\$132.00
53494	CS2000	2000 g x 1 g	132.00
53495	CS5000	5000 g x 1 g	155.00
53496	CS2000P*	2000 g x 1 g	142.00
53497	CS5000P*	5000 g x 1 g	169.00
83225	CS200P*	200 g x 0.1 g	142.00

## Options/Accessories

PART #	MODEL #	DESCRIPTION	PRICE
33423	90524-66	AC adapter for CS models (current-version 2)	\$45.00
70430	80500457	AC adapter for CS models (older-version 1)	50.00
70434	80850075	Bowl, 1050 mL	36.00
70435	80850076	Stainless steel weighing pan cover	39.00

Ohaus

## CL Series

Compact Scale

Capacity: 200g-5000g    Readability: 0.1g-1g

BALANCES

### Standard Features

- Basic weighing with simple 2-button keypad
- Superior RF protection
- Large weighing platform
- Stackable design with integrated shipping lock
- Low battery indicator
- Auto shut-off feature
- Mechanical and software overload protection
- External push-button calibration
- Battery (standard) or AC adapter (optional) operation



### Specifications

	CL201	CL2000	CL5000
<b>Part #</b>	<b>103101</b>	<b>103102</b>	<b>103103</b>
<b>List Price</b>	<b>\$83.00</b>	<b>\$83.00</b>	<b>\$113.00</b>
Capacity	200 g	2000 g	5000 g
<b>Resolution</b>	<b>0.1 g</b>	<b>1 g</b>	<b>1 g</b>
Weighing Modes	g, lb:oz, ozt, dwt		
Repeatability	0.1 g	1 g	1 g
Linearity	± 0.1 g	± 1 g	± 1 g
Stabilization Time	3 seconds		
Operating Temperature	65° to 77° F (18° to 25° C)		
<b>Pan Size</b>	<b>Ø 4.75 in (12.0 cm)</b>		
Dimensions	5.5 x 1.6 x 7.9 in (14 x 4.0 x 20 cm)		
Weight (Approx.)	0.875 lb (0.4 kg)		
Power	3 "AA" batteries (included) (AC adapter is optional)		
Battery Life	300 hours		
Warranty	One-year limited warranty		
Return Policy	Ohaus Standard Policy - restock fee may apply		

### Part Number/Price

PART #	MODEL #	DESCRIPTION	PRICE
103101	CL201	200 g x 0.1 g	\$83.00
103102	CL2000	2000 g x 1 g	83.00
103103	CL5000	5000 g x 1 g	113.00

### Options/Accessories

PART #	MODEL #	DESCRIPTION	PRICE
70434	80850075	Bowl for CS compact scales (1050 ml)	\$36.00
33423	90524-66	AC adapter for CL	45.00
103521	80010624	Carrying case for CS and CL scales	45.00
33455	5076-00	Aluminum scoop, 1.5 x 2 in (3.8 x 5.1 cm), weight 4 g	25.00
33456	5077-00	Gold scoop, 2.25 x 3 in (5.7 x 7.6 cm), weight 10 g	25.00
33454	4590-30	Black scoop, aluminum 4 x 3.5 in (10.2 x 8.9 cm), weight 24 g	26.00

www.ricelake.com | Phone: 800-472-6703

RICE LAKE



Ohaus

## HH Series

Handheld Compact Scale

Capacity: 60g-320g    Readability: 0.1 g-0.2g

BALANCES

### Standard Features

- Weighing modes: g (HH120D); g, oz, dwt, ozt (HH120, HH320)
- Large 0.4in (10.16 mm) high-contrast backlit Liquid Crystal Display (LCD)
- Low-battery indicator
- Overload and underload indicators
- Auto shut-off
- Protective snap-on cover
- Rugged plastic construction



### HH120/320 Additional Features

- Push-button luminescent display and soft tactile feedback keypad with protective cover

### Specifications

	HH120D	HH120	HH320
<b>Part #</b>	<b>52541</b>	<b>64055</b>	<b>52540</b>
<b>List Price</b>	<b>\$139.00</b>	<b>\$166.00</b>	<b>\$207.00</b>
Capacity	60/120 g	120 g	320 g
<b>Resolution</b>	<b>0.1/0.2 g</b>	<b>0.1 g</b>	<b>0.1 g</b>
Weighing Modes	-	Grams, Ounces, Pennyweight, Troy Ounces	
Maximum overload	150% of capacity		
Linearity	±0.1/±0.2	±0.1	±0.2
Stabilization Time	3 seconds		
<b>Pan Size</b>	<b>3.25 x 3.2 in (82.55 x 76.2 mm)</b>		
Dimensions	5.35 x 3.25 x 0.8 in (13.6 x 8.5 x 2 cm)		
Weight (Approx.)	0.34 lb (0.16 kg)		
Calibration	Factory set	Calibration with keypad	
Auto Shutoff	Two minutes no activity		
Power	Battery operated		
Warranty	One-year limited warranty		
Return Policy	Ohaus Standard Policy - restock fee may apply		

### Part Number/Price

PART #	MODEL #	DESCRIPTION	PRICE
52541	HH120D	60/120 g x 0.1/0.2 g	\$139.00
64055	HH120	120 g x 0.1 g	166.00
52540	HH320	320 g x 0.1 g	207.00

www.ricelake.com | Phone: 800-472-6703

RICE LAKE

## Standard Features

- Smaller size than most pocket scales allows a comfortable fit in your pocket
- Clamshell case designs protects scale during transport
- Weighs in g, oz, ct and grain
- Bright blue backlit LCD display



## Specifications

	YA102	YA302
<b>Part#</b>	<b>103106</b>	<b>103107</b>
<b>List Price</b>	<b>\$84.00</b>	<b>\$72.00</b>
Capacity	100 g	300 g
<b>Resolution</b>	<b>0.01 g</b>	<b>0.05 g</b>
Weighing Modes	Grams, Ounces, Carats and Grains	
Calibration	External	
Auto Shutoff	10 to 30 seconds	
Power	2 AAA Batteries	
Warranty	One-year limited warranty	
Return Policy	Ohaus Standard Policy - restock fee may apply	

## Part Number/Price

PART #	MODEL #	DESCRIPTION	PRICE
103106	YA102	100 g x 0.01 g	\$84.00
103107	YA302	300 g x 0.05 g	72.00

## Options/Accessories

PART #	MODEL #	DESCRIPTION	PRICE
33455	5076-00	Aluminum scoop, 1.5 x 2 in (3.8 x 5.1 cm), weight 4 g	\$25.00
33456	5077-00	Gold scoop, 2.25 x 3 in (5.7 x 7.6 cm), weight 10 g	25.00
33454	4590-30	Black scoop, aluminum 4 x 3.5 in (10.2 x 8.9 cm), weight 24 g	26.00

### Standard Features

- Notched and tiered beams for easy reading
- Positive poise positioning for repeatability
- Magnetically damped
- Zero adjust compensator
- Choice of five weighing platforms: stainless steel pan, polypropylene scoop, stainless steel scoop, aluminum animal box, stainless steel plate
- Optional tare beam vernier dial



Triple Pro Beam with Attachment Weight

TP261I



### Specifications

	710-00	710-T0	720-00	750-S0	760-00	720-S0
<b>Part#</b>	33350	33351	33352	33355	33357	33353
<b>List Price</b>	\$223.00	\$273.00	\$264.00	\$163.00	\$231.00	\$306.00
Capacity	610g	610g	610g	610g	610g	610g
<b>Resolution</b>	<b>0.1g</b>	<b>0.1g</b>	<b>0.1g</b>	<b>0.1g</b>	<b>0.1g</b>	<b>0.1g</b>
Tare Range	-	225g	-	-	225g	-
Pan Design	Stainless steel pan	Stainless steel pan with Tare	Polypropylene scoop	Stainless steel plate	Stainless steel plate with tare	Stainless steel scoop
<b>Pan Size</b>	<b>Ø 6 in (152.4 mm)</b>		-	<b>Ø 6 in (152.4 mm)</b>		-
Dimensions	18 x 12 x 9 in (457.2 x 304.8 x 228.6 mm)					
Weight (Approx.)	8 lb					
Calibration	Front beam 10 x 0.1g, Middle beam 500 x 100g, Rear beam 100 x 10g					
Warranty	Five-year limited warranty					
Return Policy	Ohaus Standard Policy - restock fee may apply					

	730-00	1650-00*	1650-W0*	1610-00*	TP2611
<b>Part#</b>	33354	33361	33362	33360	103109
<b>List Price</b>	\$330.00	\$294.00	\$338.00	\$338.00	\$227.00
Capacity	610g	610g	2610g	610g	2610g
<b>Resolution</b>	<b>0.1g</b>	<b>0.1g</b>	<b>0.1g</b>	<b>0.1g</b>	<b>0.1g</b>
Tare Range	-	225g	225g	225g	-
Pan Design	Aluminum weight boat	Stainless steel plate with tare			Stainless steel pan with rod and clamp
<b>Pan Size</b>	-	<b>6 in (152.4 mm)</b>			<b>5.8 x 5.8 in (147.3 x 147.3 mm)</b>
Dimensions	18 x 12 x 9 in (457.2 x 304.8 x 228.6 mm)				
Weight (Approx.)	8 lb (3.6 kg)				
Calibration	Front beam 10 x 0.1g, Middle beam 500 x 100g, Rear beam 100 x 10g				
Warranty	Five-year limited warranty				
Return Policy	Ohaus Standard Policy - restock fee may apply				

\*Dial-O-Gram models

Ohaus

## Triple Beam

Mechanical Balance

BALANCES

### Part Number/Price

PART #	MODEL #	DESCRIPTION	PRICE
33350	710-00	610g x 0.1 g	\$223.00
33351	710-T0	610g x 0.1 g	273.00
33352	720-00	610g x 0.1 g	264.00
33355	750-S0	610g x 0.1 g	163.00
33357	760-00	610g x 0.1 g	231.00
33353	720-S0	610g x 0.1 g	306.00
33354	730-00	610/2610g x 0.1 g	330.00
33361	1650-00	610g x 0.1 g	294.00
33362	1650-W0	2610g x 0.1 g	338.00
33360	1610-00	610g x 0.1 g	338.00
103109	TP2611	2610g x 0.1 g	227.00

### Options/Accessories

PART #	MODEL #	DESCRIPTION	PRICE
33417	183-00	Rod and clamp assembly	\$50.00
33446	703-00	Polypropylene scoop, 12 x 6 x 2.75 in (304 x 152 x 70 mm) footed and counterweighted for balance with out tare	37.00
33447	703-S0	Stainless steel scoop, 12 x 6 x 2.75 in (304 x 152 x 70 mm) footed and counterweighted for balance with out tare	88.00
33448	704-00	Polypropylene Maxi-Scoop®, 10 in (254 mm) dia. x 2.5 in (70 mm) Deep with pouring spout and counterweight	40.00
33463	706-00	Vinyl dust cover	26.00
33414	707-00	Attachment weight set, metric	52.00

www.ricelake.com | Phone: 800-472-6703

RICE LAKE

Ohaus

# Harvard Trip Balance

Mechanical Beam

Capacity: 2000g    Readability: 0.1 g

BALANCES

## Standard Features

- Highly versatile, rugged and accurate
- Two-pan design ideal for comparative weighing
- Built-in sliding masses
- Roberval principle
- Magnetic damping
- Comparative weighing
- Five-year limited warranty



## Specifications

	1450-SD	1550-SD	1560-SD
<b>Part#</b>	<b>33364</b>	<b>33367</b>	<b>33368</b>
<b>List Price</b>	<b>\$304.00</b>	<b>\$326.00</b>	<b>\$340.00</b>
Capacity	2000 g	2000 g	2000 g
<b>Resolution</b>	<b>0.1 g</b>	<b>0.1 g</b>	<b>0.1 g</b>
Pan Design	Two pan design; stainless steel plate		
<b>Pan Size</b>	<b>6 in (152.4 mm)</b>		
Dimensions	25 x 18 x 22 in (63.5 x 45.8 x 55.9 cm)		
Calibration	Top Beam 10 x 0.1 lb; Bottom beam 200 x 10 g		
Warranty	Five-year limited warranty		
Return Policy	Ohaus Standard Policy - restock fee may apply		

## Part Number/Price

PART #	MODEL #	DESCRIPTION	PRICE
33364	1450-SD	2000 g x 0.1 g, single beam	\$304.00
33367	1550-SD	2000 g x 0.1 g, two beam	326.00
33368	1560-SD	2000 g x 0.1 g, two beam with tare	340.00

## Options/Accessories

PART #	MODEL #	DESCRIPTION	PRICE
33461	106-00	Vinyl dust cover for Harvard Trip Balances	\$28.00
33417	183-00	Rod and clamp assembly for Triple Beam or Harvard Trip	50.00

www.ricelake.com | Phone: 800-472-6703

RICE LAKE

Ohaus

# Dial-O-Gram® and Cent-O-Gram®

Capacity: 310g-311g Readability: 0.01g

Mechanical Balances

BALANCES

## Standard Features

- 0.01 g or 0.1 g sensitivity
- Equipped for specific gravity weighing
- Four-tiered notched beams
- Easy-to-read vernier dial on model 310
- See-through poise on model 311
- High precision and remarkable value
- Three-point beam eliminates need for level adjustment
- Quick-zeroing with zero adjust knob
- Five-year limited warranty



## Specifications

	310-00	311-00
<b>Part #</b>	<b>33371</b>	<b>33370</b>
<b>List Price</b>	<b>\$325.00</b>	<b>\$268.00</b>
Capacity	310 g	311 g
<b>Resolution</b>	<b>0.01 g</b>	<b>0.01 g</b>
Operating Mode	Dial	Poise
<b>Pan Size</b>	<b>6 in (152.4 mm)</b>	
Platform	Stainless steel (removable) 3.5 x 0.5 in (88.9 x 12.7 mm)	
Calibrations	Front beam-225 g tare Middle beam-500 g x 100 g, Rear beam-100 g x 10 g; Dial-10 g x 0.1 g	
Weight (Approx.)	5 lb (2.3 kg)	
Warranty	Five-year limited warranty	
Return Policy	Ohaus Standard Policy - restock fee may apply	

## Part Number/Price

PART #	MODEL #	DESCRIPTION	PRICE
33371	310-00	310 g x 0.01 g	\$325.00
33370	311-00	311 g x 0.01 g	268.00

## Options/Accessories

PART #	MODEL #	DESCRIPTION	PRICE
33420	76912-01	Test tube kit	\$50.00
33462	110-00	Vinyl dust cover	26.00
Additional OHAUS Mechanical Balance Accessories			
33414	707-00	Metric attachment mass set	52.00
33450	1101-20	Polypropylene scoop, 12 x 6 in 2.75 in (304 x 152 x 70 mm) footed, tare 125 g	26.00
33451	3369-10	Polypropylene Maxi-Scoop®, 10 in (254 mm) dia. x 2.5 in (63 mm) D w/pouring spout	35.00
33454	4590-30	Black scoop, aluminum, 4 x 3.5 in (102 x 89 mm)	26.00
33455	5076-00	Aluminum scoop, 1.5 x 2 in (38 x 51 mm)	25.00
33456	5077-00	Gold scoop, 2.25 x 3 in (57 x 76 mm)	25.00

www.ricelake.com | Phone: 800-472-6703

RICE LAKE

Ohaus  
**Field Test Scale**  
 Mechanical Balance

Capacity: 16 kg, 36 lb    Readability: 5 g-0.01 lb

**Standard Features**

- Affordable compact industrial scale
- Large, stabilized pan can hold oversized samples without tipping
- Readings up to 500 g are taken from a single sliding-weight beam, while a set of slotted weights, stored in the base, can extend the capacity up to 36 lb
- Five-year limited warranty



**Specifications**

	2400-11	2400-12
<b>Part #</b>	<b>33379</b>	<b>33380</b>
<b>List Price</b>	<b>\$1,133.00</b>	<b>\$1,174.00</b>
Capacity	16 kg	36 lb
<b>Resolution</b>	<b>5 g</b>	<b>0.01 lb</b>
Operating Mode	Poise	Poise
Platform	11 in (27.9 cm)	
Calibrations	Bottom beam-500 x 5 g; Top beam-1 x 0.01 lb	
Weight (Approximate)	12 lb (5.4 kg)	
Warranty	Five-year limited warranty	
Return Policy	Ohaus Standard Policy - restock fee may apply	

**Part Number/Price**

PART #	MODEL #	DESCRIPTION	PRICE
33379	2400-11	16 kg x 5 g	\$1,133.00
33380	2400-12	36 lb x 0.01 lb	1,174.00

Ohaus

# Heavy Duty Solution

Mechanical Balance

Capacity: 20kg    Readability: 1g

BALANCES

## Standard Features

- Sets an industry standard for precision in high-capacity weighing
- Durable enough to resist corrosion
- Sensitive enough to weigh with a feather's touch
- Large stainless steel platform
- Lockable tare for containers up to 2270 g
- Self-aligning bearings assure a long, maintenance-free life
- Five-year limited warranty



## Specifications

1119-D0	
<b>Part #</b>	<b>33378</b>
<b>List Price</b>	<b>\$1,842.00</b>
Capacity	20 kg
<b>Resolution</b>	<b>1 g</b>
Operating Mode	Poise
<b>Pan Size</b>	—
Platform	11 in (27.9 cm)
Calibrations	Front beam-100 x 1 g; Rear beam-1000 x 100 g
Weight (Approx.)	12 lb
Warranty	Five-year limited warranty
Return Policy	Ohaus Standard Policy - restock fee may apply

## Options/Accessories

PART #	MODEL #	DESCRIPTION	PRICE
33378	1119-D0	20 kg x 1 g	\$1,842.00

www.ricelake.com | Phone: 800-472-6703

RICE LAKE



## Standard Features

- Designed for food service and other industrial applications with a focus on speed, durability and cleanliness
- All stainless steel, high-quality formed construction for sanitary cleaning and durability
- Checkweighing function for food packaging and preparation
- Internal rechargeable battery assures excellent portability
- Stainless steel housing and pan with non-slip rubber feet
- Checkweighing mode with 3-LED indicator and audible alarm
- Bright backlit LCD display
- Stable weight display within 2 seconds
- Multiple weighing units: lb, decimal/fractional oz, kg, g and lb
- AC power or internal rechargeable lead acid battery
- NSF-certified, USDA-AMS accepted, supports HACCP compliance
- EC/OIML type approved

*Note: NTEP and Measurement Canada 3000e approved resolution is specific only to model without the "H" suffix. Units ship in non-NTEP resolution*



## Approvals



Measurement  
 Canada  
 Approved

## Specifications

	FD3H	FD3	FD6H	FD6	FD15H	FD15
<b>Part#</b>	<b>102774</b>	-	<b>102775</b>	-	<b>102776</b>	-
<b>List Price</b>	<b>\$722.00</b>	-	<b>\$722.00</b>	-	<b>\$722.00</b>	-
<b>NTEP Part#</b>	-	<b>87824</b>	-	<b>87825</b>	-	<b>87826</b>
<b>NTEP List Price</b>	-	<b>\$656.00</b>	-	<b>\$656.00</b>	-	<b>\$656.00</b>
Capacity	6 lb	6 lb	15 lb	15 lb	30 lb	30 lb
<b>Resolution</b>	<b>0.0002 lb</b>	<b>0.002 lb</b>	<b>0.001 lb</b>	<b>0.005 lb</b>	<b>0.001 lb</b>	<b>0.01 lb</b>
Overload capacity	150%					
Operating Modes	Weighing, Checkweighing					
Repeatability	0.2 g		0.4 g		.2 g	
Linearity	±0.2 g		±0.4 g		±0.2 g	
Stabilization Time	< 2 seconds					
Operating Temperature	14° F to 104° F (-10° C to 40° C) 10 to 85% relative humidity, non-condensing					
Environmental	IP43					
<b>Pan Size</b>	<b>8.2 x 8.2 in (209 x 209 mm)</b>					
Dimensions	9 x 12 x 2.8 in (300 x 223 x 71 mm)					
Weight (Approx.)	8 lb (3.6 kg)					
Est. Ship Weight	11 lb (5 kg)					
Power	120V AC adapter, 9V DC 0.5A 50/60Hz (Other adapters available by special request)					
Battery life	Maximum 120 hours					
Approvals	NSF listed/Certified to NSF C-2, UL C-US listed, NTEP Class III, Measurement Canada					
Warranty	One-year limited warranty					
Return Policy	Ohaus Standard Policy - restock fee may apply					
<b>UNIT OF MEASURE</b>						
Kilogram	3 x 0.0001 kg	3 x 0.001 kg	6 x 0.0002 kg	6 x 0.002 kg	15 x 0.005 kg	15 x 0.005 kg
Grams	3000 x .1 g	3000 x 1 g	6000 x 0.2 g	6000 x 2 g	-	15000 x 5 g
Ounce	96 oz x 0.005 oz; 96 oz x 1/4 oz	96 oz x 0.05 oz or 1/4 oz	240 oz x 0.01 oz; 240 oz x 1/4 oz	240 oz x 0.1 oz or 1/4 oz	480 oz x 0.02 oz or 1/4 oz	480 oz x 0.2 oz or 1/4 oz
Pound x Ounce	6 lb 0 oz x 1/4 oz; 6 lb 0 oz x 0.1 oz	N/A	15 lb 0 oz x 0.1 oz; 15 lb 0 oz x 1/4 oz	N/A	30 lb 0 oz x 0.1 oz or 1/4 oz	N/A

Ohaus

## FD Series

Food Portioning Scale

BALANCES

### Part Number/Price

PART #	MODEL #	DESCRIPTION	PRICE
102774	FD3H	6 lb x 0.0002 lb	\$722.00
87824	FD3 (NTEP)	6 lb x 0.002 lb	656.00
102775	FD6H	15 lb x 0.001 lb	722.00
87825	FD6 (NTEP)	15 lb x 0.005 lb	656.00
102776	FD15H	30 lb x 0.001 lb	722.00
87826	FD15 (NTEP)	30 lb x 0.01 lb	656.00

### Options/Accessories

PART #	MODEL #	DESCRIPTION	PRICE
103118	80251394	Hard shell carrying case for FD	\$88.00
87827	71169633	Foot tare switch for FD	122.00
103116	80251141	Flat pan for FD or Valor 5000	45.00
103117	80251140	In-use cover for FD or Valor 5000	26.00
33451	3369-10	Polypropylene Maxi-Scoop™ 10 dia x 2.5 in deep (25.4 dia x 6.4 cm deep) with pouring spout, weight 145 g	35.00
97250	80250400	Stainless steel scoop 11.9 x 7.4 x 1.7 in (30 x 18.7 x 4.3 cm)	50.00
100292	80250954	Stainless steel scoop 17.2 x 11 x 3.4 in (44 x 28 x 8.5 cm)	62.00
98020	80500435	AC Adapter	50.00

www.ricelake.com | Phone: 800-472-6703

RICE LAKE

Ohaus

# Navigator™ XT

Battery-Operated Compact Scale

Capacity: 1600g - 16,000g Readability: 0.1g - 1g

BALANCES

## Standard Features

- Touchless IR (infrared) sensors minimize keypad use
- Program IR sensor to control zero, print tare, backlight and power functions
- Backlit 0.8 in LCD display for high visibility
- Illuminated level indicator at start-up
- Integrated transportation and calibration lock switch
- Hygienic design for easy cleanup in food, laboratory and industrial applications
- IP43 rating
- Impact-resistant ABS plastic housing with polished stainless steel spill-resistant pan
- Non-skid leveling feet
- Internal rechargeable battery



## Specifications

	NVT1601/1	NVT3201/1	NVT6401/1	NVT10001/1	NVT16000/1
<b>Part Number</b>	<b>117909</b>	<b>117910</b>	<b>117911</b>	<b>117912</b>	<b>117913</b>
<b>List Price</b>	<b>\$444.00</b>	<b>\$444.00</b>	<b>\$428.00</b>	<b>\$444.00</b>	<b>\$444.00</b>
Capacity	1600g	3200g	6400g	10000g	16000g
<b>Resolution</b>	<b>0.1g</b>	<b>0.2g</b>	<b>0.5g</b>	<b>0.5g</b>	<b>1g</b>
Weighing Modes	Pound, Ounce, Pound: Ounce, Kilogram, Gram, Troy Ounce, Grain, Newton, Carat, Pennyweight, Tael (Hong Kong, Taiwan, Singapore), Tical, Tola				
Operating Modes	Weighing, Percent, Parts counting, Checkweighing, Display Hold, Accumulation/Totalization				
Linearity	0.1g/+/-0.2g	0.2g/+/-0.4g	0.5g/+/-1g	0.5g/+/-1g	1g/+/-2g
Stabilization Time	1 second				
Operating Temperature	50° F to 104° F (10° C to 40° C) at 20-85% RH				
<b>Pan Size</b>	<b>9 x 6.9 in (230 x 174 mm)</b>				
Dimensions	9.5 x 9.8 x 2.8 in (240 x 250 x 70 mm)				
Weight (Approx.)	4.3 lb (2.0 kg)				
Est. Shipping Weight	6.1 lb (2.8 kg)				
Ext. Cal. Mass (optional)	2 lb (1 kg)	5 lb (2 kg)	10 lb (5 kg)	10 lb (5 kg)	20 lb (10 kg)
Power	12 VDC 0.42A AC adapter, 100-240V, Internal Rechargeable Battery 100-hr operation with 12-hr full charge				
Warranty	One-year limited warranty				
Return Policy	Ohaus Standard Policy - restock fee may apply				

## Part Number/Price

PART #	MODEL #	DESCRIPTION	PRICE
117909	NVT1601/1	1600g x 0.1g	\$444.00
117910	NVT3201/1	3200g x 0.2g	444.00
117911	NVT6401/1	6400g x 0.5g	428.00
117912	NVT10001/1	10,000g x 0.5g	444.00
117913	NVT16000/1	16,000g x 1g	444.00

## Options/Accessories

PART #	MODEL #	DESCRIPTION	PRICE
118779	83032107	RS-232 interface kit, Navigator series	\$132.00
118780	83032108	USB interface kit	132.00
118781	83032109	Ethernet interface kit	132.00
118782	83032221	In-use cover	21.00
118783	83032224	Carrying case	79.00
156236	46001802	Universal AC adapter	40.00
156235	46001780	Plug set	15.00

www.ricelake.com | Phone: 800-472-6703

RICE LAKE

## Standard Features

- Touchless sensors
- Backlit dual LCD display
- Illuminated up-front level indicator
- Internal rechargeable battery
- ABS plastic housing
- Skid-resistant leveling feet
- Menu lock switch
- Multiple application modes
- RS-232, standard
- Fast stabilizing time



## Approvals



## Specifications

	V71P1502T	V71P3T	V71P6T	V71P15T	V71P30T
<b>Part#</b>	<b>157316</b>	<b>157317</b>	<b>157318</b>	<b>157319</b>	<b>157320</b>
<b>List Price</b>	<b>\$524.00</b>	<b>\$524.00</b>	<b>\$524.00</b>	<b>\$524.00</b>	<b>\$524.00</b>
Capacity	1.5 kg	3 kg	6 kg	15 kg	30 kg
<b>Resolution</b>	<b>0.00005 kg</b>	<b>0.0001 kg</b>	<b>0.0002 kg</b>	<b>0.0005 kg</b>	<b>0.001 kg</b>
Weighing modes	Weighing, Percent, Checkweighing, Accumulation				
Units of Measures	Pound, Ounce, Kilogram, Gram				
Pounds	3 x 0.0001	6 x 0.0002	15 x 0.0005	30 x 0.001	60 x 0.002
Grams	1500 x 0.05	3000 x 0.1	6000 x 0.2	15000 x 0.5	30000 x 1
Ounces	48 x 0.002	96 x 0.005	240 x 0.01	480 x 0.02	960 x 0.05
Operating Temperature	14 to 104 F/-10 to 40 C				
<b>Pan Size</b>	<b>11.8 x 8.9 in (300 x 225 mm)</b>				
Dimensions	12.2 x 12.9 x 4.6 in (311 x 327 x 117 mm)				
Weight (Approx.)	9.2 lb. (4.2 kg)				
Power	100-240V, Internal Rechargeable Battery 210-hr operation with 12-hr full charge				
Warranty	One-year limited warranty				
Return Policy	Ohaus Standard Policy - restock fee may apply				

## Part Number/Price

PART #	MODEL #	DESCRIPTION	PRICE
157316	V71P15025	1.5 kg x 0.00005 kg	\$524.00
157317	V71P3T	3 kg x 0.0001 kg	524.00
157318	V71P6T	6 kg X 0.0002 kg	524.00
157319	V71P15T	15 kg X 0.0005 kg	524.00
157320	V71P30T	30 kg X 0.001kg	524.00

## Options/Accessories

PART #	MODEL #	DESCRIPTION	PRICE
154638	30037447	Ethernet Kit	\$104.00

## Standard Features

- Full 304 stainless steel housing with chemical resistant keypad
- Removable stainless steel weighing pan
- USDA approved
- Supports HACCP
- Resolutions up to 20,000d
- SmarText user interface
- Standard AC Power adapter
- Bright backlit LCD display
- Convenient up-front level device
- NSF Listed
- NTEP models available by special order



## Specifications

	V31XH202	V31XH402	V31X501	V31XH2	V31X3	V31XH4	V31X6
<b>Part #</b>	100283	117790	117789	100284	100285	117792	100286
<b>List Price</b>	\$592.00	\$766.00	\$446.00	\$592.00	\$405.00	\$813.00	\$405.00
Capacity	200 g	400 g	500 g	2 g	3 kg	4 kg	6 kg
<b>Resolution</b>	<b>0.01 g</b>	<b>0.01 g</b>	<b>0.1 g</b>	<b>0.1 kg</b>	<b>1 g</b>	<b>0.1 g</b>	<b>1 g</b>
Weighing Modes	Pounds, Decimal or fractional Ounces, lb:oz, fluid oz (of water); Kilogram, Gram						
Operating Modes	Weighing, Percent weighing, Combined zero/tare, Specific gravity						
Protection rating	Non-Washdown models						
Stabilization Time	< 3 seconds						
Operating Temperature	32° F to 104° F (0° C to 40° C)						
<b>Pan Size</b>	<b>4.7 in (120 mm)</b>			<b>5.8 x 6.2 in (146 x 158 mm)</b>			
Dimensions	8.5 x 7.3 x 3 in (218 x 186 x 72 mm)						
Weight (Approx.)	2.6 lb (1.2 kg)			2.9 lb (1.3 kg)			
Est. Ship Weight	10 lb (4.8 kg)						
Calibration	Digital external calibration						
Power	120V AC adapter (9V DC, 0.5A), Four 1.5 Volt C batteries (not included)						
Battery life	50 hours with alkaline cells			120 hours with alkaline cells			
Warranty	One-year limited warranty						
Return Policy	Ohaus Standard Policy - restock fee may apply						

## Part Number/Price

PART #	MODEL #	DESCRIPTION	PRICE
100283	V31XH202	200 g x 0.01 g	\$592.00
117790	V31XH402	400 g x 0.01 g	766.00
117789	V31X501	500 g x 0.1 g	446.00
100284	V31XH2	2 kg x 0.1 g	592.00
100285	V31X3	3 kg x 1 g	405.00
117792	V31XH4	4 kg x 0.1 g	813.00
100286	V31X6	6 kg x 1 g	405.00

## Options/Accessories

PART #	MODEL #	DESCRIPTION	PRICE
103119	80251216	Hard shell carrying case for FD and Valor	\$88.00
102756	80251147	Sandwich pan, 11 x 5.9 in (280 x 150 mm) for Valor Xtreme	55.00
102757	80251148	French fries holder pan for Valor 3000 Xtreme	55.00
102758	80251149	Ice cream cone holder for Valor 3000 Xtreme	55.00
33451	3369-10	Polypropylene Maxi-Scoop™ 10 dia x 2.5 in deep (25.4 dia x 6.4 cm deep) with pouring spout, weight 145 g	35.00
100292	80250954	Stainless steel scoop 17.2 x 11 x 3.4 in (44 x 28 x 8.5 cm)	62.00
97250	80250400	Stainless steel scoop 11.9 x 7.4 x 1.7 in (30 x 18.7 x 4.3 cm)	50.00

Ohaus

# Valor® 3000 Xtreme

Compact Washdown Scales

Capacity: 300g-6kg    Readability: 0.01g-1g

BALANCES

## Standard Features

- Full 304 stainless steel housing with chemical resistant keypad
- Removable stainless steel weighing pan
- USDA approved
- Supports HACCP
- IP65
- NTEP models available



## Specifications

	V31XW301	V31XW3	V31XW6
<b>Part#</b>	<b>100287</b>	-	-
<b>List Price</b>	<b>\$479.00</b>	-	-
<b>NTEP</b>	<b>Part#</b>	<b>100288</b>	<b>100289</b>
	<b>List Price</b>	<b>\$479.00</b>	<b>\$479.00</b>
Capacity	300 g	3 kg	6 kg
<b>Resolution</b>	<b>0.1 g</b>	<b>1 g</b>	<b>2 g</b>
Weighing Modes	Pounds, Decimal or fractional Ounces, lb:oz, fluid oz (of water); Kilogram, Gram		
Operating Modes	Weighing, Percent weighing, Combined zero/tare, Specific gravity		
Protection Rating	IP65		
Stabilization Time	< 3 seconds		
Operating Temperature	32° F to 104° F (0° C to 40° C)		
<b>Pan Size</b>	<b>5.8 x 6.2 in (146 x 158 mm)</b>		
Dimensions	8.5 x 7.3 x 3 in (218 x 186 x 72 mm)		
Weight (Approx.)	2.9 lb (1.3 kg)		
Est. Ship Weight	10 lb (4.8 kg)		
Calibration	Digital external calibration		
Power	120V AC adapter (9V DC, 0.5A), Four 1.5 Volt C batteries (not included)		
Battery Life	50 hours with alkaline cells	120 hours with alkaline cells	
Warranty	One-year limited warranty		
Return Policy	Ohaus Standard Policy - restock fee may apply		

## Part Number/Price

PART#	MODEL#	DESCRIPTION	PRICE
100287	V31XW301	300 g x 0.1g	\$479.00
100288	V31XW3	3kg x 1 g	479.00
100289	V31XW6	6kg x 2g	479.00

## Options/Accessories

PART #	MODEL #	DESCRIPTION	PRICE
103119	80251216	Hard shell carrying case for FD and Valor	\$88.00
102756	80251147	Sandwich pan, 11 in x 5.9 in (280 x 150 mm) for Valor Xtreme	55.00
102757	80251148	French fries holder pan for Valor 3000 Xtreme	55.00
102758	80251149	Ice cream cone holder for Valor 3000 Xtreme	55.00
33451	3369-10	Polypropylene Maxi-Scoop™ 10 dia x 2.5 in deep (25.4 cm dia x 6.4 cm deep) with pouring spout, weight 145 g	35.00
100292	80250954	Stainless steel scoop 17.2 x 11 x 3.4 in (44 x 28 x 8.5 cm)	62.00
97250	80250400	Stainless steel scoop 11.9 x 7.4 x 1.7 in (30 x 18.7 x 4.3 cm)	50.00

www.ricelake.com | Phone: 800-472-6703

RICE LAKE

## Standard Features

- IPX8 protection rating
- Front and rear dual display, 0.8 in/20.5 mm
- Removable stainless steel platform cover
- Fast 0.5s stabilization time
- SmarText interface
- Knife proof keypad
- AC adapter and battery included



V22PW

## Approvals



## Specifications

	V22XWE3T	V22XWE6T	V22XWE15T
<b>Part #</b>	<b>102771</b>	<b>102772</b>	<b>102773</b>
<b>List Price</b>	<b>\$429.00</b>	<b>\$429.00</b>	<b>\$429.00</b>
Capacity	3 kg	6 kg	15 kg
<b>Resolution</b>	<b>0.5 g</b>	<b>1 g</b>	<b>2 g</b>
Weigh Units	Kilograms, Pounds, Grams, Ounces, Pound and Ounce		
Operating Modes	Weigh, Checkweigh		
Construction	ABS plastic housing, stainless steel pan		
Protection Rating	IPX8		
Safe Overload	150% of capacity		
Stabilization Time	< 1 second		
Operating Temperature	14° F to 104° F (-10° C to 40° C)		
<b>Pan Size</b>	<b>7.5x 9.5 in (242 x 190 mm)</b>		
Dimensions	10.1 x 11.3 x 4.9 in (256 x 288 x 124 mm)		
Weight (Approx.)	8.6 lb (3.9 kg)		
Calibration	Digital external calibration		
Power	Universal AC adapter, 12V DC 0.7A internal rechargeable lead acid battery		
Battery Life	50 hours with 1 hour recharge time		
Warranty	One-year limited warranty		
Return Policy	Ohaus Standard Policy - restock fee may apply		

^Weighing Chamber

## Part Number/Price

PART #	MODEL #	DESCRIPTION	PRICE
102771	V22XWE3T	3 kg x 0.5 g	\$429.00
102772	V22XWE6T	6 kg x 1 g	429.00
102773	V22XWE15T	15 kg x 2 g	429.00

## Options/Accessories

PART #	MODEL #	DESCRIPTION	PRICE
33451	3369-10	Polypropylene Maxi-Scoop™ 10 dia x 2.5 in deep (25.4 dia x 6.4 cm deep) with pouring spout, weight 145 g	\$35.00
97250	80250400	Stainless steel scoop 11.9 x 7.4 x 1.7 in (30 x 18.7 x 4.3 cm)	50.00
100292	80250954	Stainless steel scoop 17.2 x 11 x 3.4 in (44 x 28 x 8.5 cm)	62.00
156237	46001812	Universal AC adapter	40.00
156235	46001780	Plug set, US, EU, GB and AU	15.00

## Standard Features

- Removable stainless steel platform cover
- Mid-profile ABS plastic housing
- Front-mounted leveling device
- Long lasting internal rechargeable battery (standard)
- Compact footprint
- Fast response time
- Easy-to-clean



## Approvals

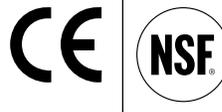

## Specifications

	V11P3	V11P6	V11P15	V11P30
<b>Part#</b>	<b>102767</b>	<b>102768</b>	<b>102769</b>	<b>102770</b>
<b>List Price</b>	<b>\$220.00</b>	<b>\$220.00</b>	<b>\$220.00</b>	<b>\$220.00</b>
Capacity	3 kg	6 kg	15 kg	30 kg
<b>Resolution</b>	<b>0.5 g</b>	<b>1 g</b>	<b>2 g</b>	<b>5 g</b>
Decimal Ounce	105 oz x 0.02 oz	210 oz x 0.05 oz	520 oz x 0.1 oz	1058 oz x 0.5 oz
Decimal Pound	6.6 lb x 0.001 lb	13 lb x 0.002 lb	33 lb x 0.01 lb	66 lb x 0.02 lb
Grams	3000 g x 0.5 g	6000 g x 1 g	15000 g x 2 g	30000 g x 5 g
Operating Modes	Weigh, accumulate, checkweigh			
Construction	ABS plastic housing, stainless steel pan			
Stabilization Time	<=3 seconds			
Operating Temperature	32° F to 104° F (0° C to 40° C) at 10% to 95% relative humidity Non-condensing, up to 2.5 miles/4000 m above sea level			
Scale Overload	120% of capacity			
<b>Pan Size</b>	<b>9.9 W x 7.1 in D (250 x 180 mm)</b>			
Dimensions	10 W x 12 D x 4.3 in H (250 x 307 x 110 mm)			
Weight (Approx.)	7 lb (3.2 kg)			
Est. Ship Weight	8.8 lb (4.0 kg)			
Power	Universal AC adapter included (9V DC 500 mA) Internal rechargeable sealed lead acid battery (included)			
Battery life	80/100 hours (with/without backlight on) with 12-hour recharge time			
Warranty	One-year limited warranty			
Return Policy	Ohaus Standard Policy - restock fee may apply			

## Part Number/Price

PART #	MODEL #	DESCRIPTION	PRICE
102767	V11P3	3 kg x 0.5 g	\$220.00
102768	V11P6	6 kg x 1 g	220.00
102769	V11P15	15 kg x 2 g	220.00
102770	V11P30	30 kg x 5 g	220.00

^Weighing Chamber

## Options/Accessories

PART #	MODEL #	DESCRIPTION	PRICE
33451	3369-10	Polypropylene Maxi-Scoop™ 10 dia x 2.5 in deep (25.4 dia x 6.4 cm deep) with pouring spout, weight 145 g	\$35.00
97250	80250400	Stainless steel scoop 11.9 x 7.4 x 1.7 in (30 x 18.7 x 4.3 cm)	50.00
100292	80250954	Stainless steel scoop 17.2 x 11 x 3.4 in (44 x 28 x 8.5 cm)	62.00
156237	46001812	Universal AC adapter	40.00
156235	46001780	Plug set, US, EU, GB and AU	15.00



## Standard Features

- Underweigh function
- RS-232 full-duplex interface
- GLP/GMP printout protocol
- Backlit LCD display
- isoCAL calibration
- Reptest
- SQ min
- Configured printout
- Additional printer port: user friendly design, displays menu and prompts in plain English
- Number keys
- Alpha keys
- Applications on board: counting, checkweighing, percent weighing, unit toggle, net total, backweighing, animal weighing, formulation, statistics, calculation, timer, density determination, memory (300)
- Easily removed draft chamber for cleaning or retrieval of dropped samples



## Specifications

ME36S <sup>^</sup>	
<b>Part #</b>	<b>98034</b>
<b>List Price</b>	<b>\$21,040.00</b>
Capacity	31 g
<b>Resolution</b>	<b>0.001 mg</b>
Weighing Modes	Grams, Kilograms, Carats, Pounds, Ounces, Troy ounces, Hong Kong Taels, Singapore taels, Grains, Pennyweights, Milligrams, Parts per pound, Chinese taels, Momme, Austrian carats, Tola, Baht, Mesghal
Operating Modes	Counting, Checkweighing, Percent weighing, Unit toggle, Animal weighing, Net total, Formulation, Statistics, Calculation, Timer, Backweighing, Density Determination, Memory (300), Diameter Determination
Repeatability	2 µ
Linearity	10 µ
Stabilization Time	14-18 seconds
Operating Temperature	41°F to 104°F (5°C to 40°C)
Weighing Chamber Dimensions	8.7 x 7 x 7 in (222 x 180 x 180 mm)
<b>Pan size</b>	<b>Ø 1.2 in (30 mm)</b>
Dimensions	Weight cell 222 x 419 x 290 mm Electronic unit 254 x 320 x 106 mm
Est. Ship Weight	40 lb
Calibration Weight	5 g
Power	120V AC adapter
Warranty	Two-year limited warranty
Return Policy	Sartorius Standard Policy - restock fee may apply

<sup>^</sup> Weighing Chamber

## Part Number/Price

PART #	MODEL #	DESCRIPTION	PRICE
98034	ME36S	31 g x 0.001 mg	\$21,040.00

## Options/Accessories

PART #	MODEL #	DESCRIPTION	PRICE
112261	YDP20-OCE	Data printer with statistics and time/date functions (included cable fits RS-232)	\$980.00
31103	6906937	Paper for data printer, 5 pack	38.00
31106	6906918	Replacement ribbon for data printer	44.00
31071	YRB05Z	Battery pack, rechargeable, external	625.00
152036	6971413	Power supply, 110V	72.00

## Standard Features

- Module Design
- User configurable and custom designed to meet changing applications
- Meets advanced Pharma compliance including user/password management for security, audit trail function logs, and integrated alibi memory
- Q-guide enables tasks and work
- Electrically conductive coating on glass panels of draft shield
- RS-232 and USB communication

### Choice of Display

- MSE—Large 19 mm LCD display segments and easy menu system
- MSU—Monochrome graphic display, positive click on keys to activate functions, Ethernet, and SD Card Reader
- MSA—TFT Color touch screen, Ethernet, and SD Card Reader



The modular system offers you a choice of display and control units, weighing modules and draft shields

## Specifications

	2.7S-000-DM <sup>^</sup>	2.7S-000-DF <sup>^</sup>	6.6S-000-DM <sup>^</sup>	6.6S-000-DF <sup>^</sup>	3.6P-000-DM <sup>^</sup>	
<b>MSE*</b>	<b>Part#</b>	126044	126046	126048	126049	126052
	<b>List Price</b>	\$30,545.00	\$31,365.00	\$23,895.00	\$24,715.00	\$18,235.00
<b>MSU**</b>	<b>Part#</b>	126043	126045	126047	126050	126051
	<b>List Price</b>	\$31,575.00	\$32,395.00	\$24,925.00	\$25,745.00	\$19,265.00
<b>MSA***</b>	<b>Part#</b>	126034	126039	126040	126041	126042
	<b>List Price</b>	\$32,090.00	\$32,910.00	\$25,440.00	\$26,260.00	\$19,780.00
Capacity	2.1 g	2.1 g	5.1 g	5.1 g	1.1/2.1/3.1 g	
Resolution	0.0001 mg	0.0001 mg	0.001 mg	0.001 mg	0.001/0.002/0.005 mg	
Weighing Modes	Grams, Kilograms, Carats, Pounds, Ounces, Troy Ounces, Hong Kong Taels, Singapore taels, Grains, Pennyweights, Milligrams, Parts per Pound, Chinese taels, Momme, Austrian carats, Tola, Baht, Mesghal					
Operating Modes (*)	Counting, Checkweighing, Percent weighing, Unit toggle, Animal weighing, Net total, Formulation, Statistics, Calculation, Timer, Back-weighing, Density Determination, Memory (300), Diameter Determination					
Repeatability	0.25 µg		0.001 mg		0.003/0.004/0.005 mg	
Linearity	0.9 µg		4 µg		4 µg	
Stabilization Time	7 seconds		5 seconds		5 seconds	
Operating Temperature	41° F to 104° F (+5° C to 40° C)					
Weighing Chamber (DE)	2.75 in (70 mm) H	0.6 in (15 mm) H	2.75 in (70 mm) H	0.6 in (15 mm) H	2.75 in (70 mm) H	
<b>Pan Size</b>	<b>Ø 0.8 in (20 mm)</b>	<b>Ø 1.9 in (50 mm) dia</b>	<b>Ø 1.2 in (30 mm)</b>	<b>Ø 1.9 in (50 mm)</b>	<b>Ø 1.2 in (30 mm)</b>	
Dimensions						
Weight (Approx.)	17 lb				17 lb	
Est. Ship Weight	28 lb				40 lb	
Calibration Weight	2 g		5 g		3 g	
Power	100 - 240V Power Supply					
Warranty	Two-year limited warranty					
Return Policy	Sartorius Standard Policy - restock fee may apply					

<sup>^</sup>Weighing Chamber

\*MSE Large LCD display and easy to use menu system

\*\*MSU Monochrome graphic display, positive click on keys to activate functions, Ethernet and SD card reader

\*\*\*MSA TFT color touchscreen, Ethernet and SD card reader

DF-SS manual draft shield for weighing filters

## Part Number/Price

PART #	MODEL #	DESCRIPTION	PRICE
126044*	MSE2.7S-000-DM	2.1 g x 0.0001 mg	\$30,545.00
126043**	MSU2.7S-000-DM	2.1 g x 0.0001 mg	31,575.00
126034***	MSA2.7S-000-DM	2.1 g x 0.0001 mg	32,090.00
126046*	MSE2.7S-000-DF	2.1 g x 0.0001 mg	31,365.00
126045**	MSU2.7S-000-DF	2.1 g x 0.0001 mg	32,395.00
126039***	MSA2.7S-000-DF	2.1 g x 0.0001 mg	23,895.00
126048*	MSE6.6S-000-DM	6.1 g x 0.001 mg	24,925.00
126047**	MSU6.6S-000-DM	6.1 g x 0.001 mg	25,440.00
126040***	MSA6.6S-000-DM	6.1 g x 0.001 mg	24,715.00
126049*	MSE6.6S-000-DF	6.1 g x 0.001 mg	25,745.00
126050**	MSU6.6S-000-DF	6.1 g x 0.001 mg	26,260.00
126041***	MSA6.6S-000-DF	6.1 g x 0.001 mg	18,235.00
126052*	MSE3.6P-000-DM	1.1/2.1/3.1 g x 0.001/0.002/0.005 mg	19,265.00
126051**	MSU3.6P-000-DM	1.1/2.1/3.1 g x 0.001/0.002/0.005 mg	19,780.00
126042***	MSA3.6P-000-DM	1.1/2.1/3.1 g x 0.001/0.002/0.005 mg	

## Options/Accessories

PART #	MODEL #	DESCRIPTION	PRICE
112261	YDP20-OCE	Data printer with statistics and time/date functions (included cable fits RS-232)	\$985.00
50232	6971413	AC Power supply, printer	108.00
50232	6971413	AC power supply, printer	105.00
31103	6906937	Paper for data printer, 5 pack	38.00
31106	6906918	Replacement ribbon for data printer	44.00
31071	YRB05Z	Battery pack, rechargeable, external	625.00
156906	6971987	Power supply, 120-240V	140.00
156908	6900900	Power cord, 220V (EU)	30.00

\*Large LCD display and easy to use menu system

\*\*Monochrome graphic display, positive click on keys to activate functions, Ethernet and SD card reader

\*\*\*TFT color touchscreen, Ethernet and SD card reader

## Standard Features

- Module design
- User configurable and custom designed to meet changing applications
- Meets advanced Pharma compliance including user/password management for security, audit trail function logs and integrated alibi memory
- Q-guide enables tasks and work (MSA display)
- Electrically conductive coating on glass panels of draft shield
- RS-232 and USB communication
- Easy cleaning by removing glass doors
- Underweigh hook included
- Draft shield

### Choice of display

- MSE-large LCD display and easy menu system
- MSU-monochrome graphic display, positive click on keys to activate functions, Ethernet and SD Card Reader, Auto Leveling feature
- MSA-TFT color touchscreen, Ethernet and SD Card Reader, Auto Leveling feature



The modular system offers you a choice of display and control units, weighing modules and draft shields

## Optional Features

- DA motor-driven draft shield
- DI draft shield eliminates electrostatic charges

## Specifications

	225S	225P	125P	324S	224S	324P	124S	524S	524P	
<b>MSE*</b>	<b>Part#</b>	109776	109777	109778	109779	109780	109781	109782	156269	156270
	<b>List Price</b>	\$10,815.00	\$9,295.00	\$6,695.00	\$6,805.00	\$6,075.00	\$6,025.00	\$4,995.00	\$8,245.00	\$6,695.00
<b>MSU**</b>	<b>Part#</b>	109783	109786	109788	109794	109790	109791	109792	156267	156268
	<b>List Price</b>	\$11,845.00	\$10,325.00	\$7,725.00	\$7,835.00	\$7,105.00	\$7,055.00	\$6,025.00	\$9,275.00	\$7,725.00
<b>MSA***</b>	<b>Part#</b>	109795	109796	109797	109798	109799	109800	109801	156265	156266
	<b>List Price</b>	\$12,360.00	\$10,840.00	\$8,240.00	\$8,350.00	\$7,620.00	\$7,570.00	\$6,540.00	\$9,790.00	\$8,240.00
Capacity	220 g	60/120/220 g	60/120 g	320 g	220 g	80/160/320 g	120 g	520 g	120/240/520 g	
Resolution	0.01 mg	0.01/0.02/0.05 mg	0.01/0.1 mg	0.1 mg	0.1 mg	0.1/0.2/0.5 mg	0.1 mg	0.1 mg	0.1/0.2/0.5 mg	
Weighing Modes	Grams, Kilograms, Carat, Pounds, Ounces, Troy Ounce, Tael Hong Kong, Tael Singapore, Tael Taiwan, Grain, Pennyweight, Milligram, Parts per Pound, Tael China, Mommies, Austrian Carat, Tola, Baht, Mesghal, Ton, Pound:Ounces, Newton, Micrograms									
Operating Modes	Mass Unit Conversion, SQ min function, ISO-Cal function, Density determination (Buoyancy method only with MSE), Calculation, Averaging, Formulation, Percent weighing, Totalizing, Counting, Customized identification, Statistics, Time control function, Second tare memory, Over/Under Checkweighing									
Repeatability	0.025 mg	0.015/0.04 mg	0.015/0.06 mg	0.1 mg	0.07 mg	0.1/0.2/0.4 mg	0.1 mg	0.1 mg	0.1/0.2/0.5 mg	
Linearity	0.1 mg	0.15 mg	0.15 mg	0.3 mg	0.2 mg	0.5 mg	0.2 mg	0.4 mg	0.5 mg	
Stabilization Time (sec.)	2	2	2	1	1	1	1	1	1	
Operating Temperature	41° F to 104° F (+5° C to 40° C)									
Weighing Chamber	8 x 8 x 10.2 in (205 x 205 x 261 mm)									
<b>Pan Size</b>	<b>3.3 x 3.3 in (85 x 85 mm)</b>									
Dimensions	16 x 9.8 x 14.6 in (410 x 249 x 370.4 mm) (with manual draft shield)									
Weight (Approx.)	18 lb									
Est. Ship Weight	31.9 lb				29.7 lb					
Calibration Weight	200 g	200 g	100 g	300 g	200 g	300 g	100 g	500 g		
Power	120V AC adapter auto ranging									
Warranty	Two-year limited warranty									
Return Policy	Sartorius Standard Policy - restock fee may apply									

\*MSE Large LCD display and easy to use menu system

\*\*MSU Monochrome graphic display, positive click on keys to activate functions, Ethernet and SD card reader

\*\*\*MSA TFT color touchscreen, Ethernet and SD card reader

## Part Number/Price

PART #	MODEL #	DESCRIPTION	PRICE
109776*	MSE225S-100-DU	220 g x 0.01 mg	\$10,815.00
109777*	MSE225P-100-DU	60/120/220 g x 0.01/0.02/0.05 mg	9,295.00
109778*	MSE125P-100-DU	60/120 g x 0.01/0.1 mg	6,695.00
109779*	MSE324S-100-DU	320 g x 0.1 mg	6,805.00
156269	MSE524S-100-DU	520 g x 0.1 mg	8,245.00
156270	MSE524P-100-DU	520/240/120 g x 0.5/0.2/0.1 mg	6,695.00
109780*	MSE224S-100-DU	220 g x 0.1 mg	6,075.00
109781*	MSE324P-100-DU	80/160/320 g x 0.1/0.2/0.5 mg	6,025.00
109782*	MSE124S-100-DU	120 g x 0.1 mg	4,995.00
109783**	MSU225S-100-DU	220 g x 0.01 mg	11,845.00
109786**	MSU225P-100-DU	60/120/220 g x 0.01/0.02/0.05 mg	10,325.00
109788**	MSU125P-100-DU	60/120 g x 0.01/0.1 mg	7,725.00
156267	MSU524S-100-DU	520 g x 0.1 mg	9,275.00
156268	MSU524P-100-DU	520/240/120 g x 0.5/0.2/0.1 mg	7,725.00
109794**	MSU324S-100-DU	320 g x 0.1 mg	7,835.00
109790**	MSU224S-100-DU	220 g x 0.1 mg	7,105.00
109791**	MSU324P-100-DU	80/160/320 g x 0.1/0.2/0.5 mg	7,055.00
109792**	MSU124S-100-DU	120 g x 0.1 mg	6,025.00
109795***	MSA225S-100-DU	220 g x 0.01 mg	12,360.00
109796***	MSA225P-100-DU	60/120/220 g x 0.01/0.02/0.05 mg	10,840.00
109797***	MSA125P-100-DU	60/120 g x 0.01/0.1 mg	8,240.00
156265	MSA524S-100-DU	520 g x 0.1 mg	9,790.00
156266	MSA524P-100-DU	520/240/120 g x 0.5/0.2/0.1 mg	8,240.00
109798***	MSA324S-100-DU	320 g x 0.1 mg	8,350.00
109799***	MSA224S-100-DU	220 g x 0.1 mg	7,620.00
109800***	MSA324P-100-DU	80/160/320 g x 0.1/0.2/0.5 mg	7,570.00
109801***	MSA124S-100-DU	120 g x 0.1 mg	6,540.00

\*Large LCD display and easy to use menu system

\*\*Monochrome graphic display, positive click on keys to activate functions, Ethernet and SD card reader

\*\*\*TFT color touchscreen, Ethernet and SD card reader

## Options/Accessories

PART #	MODEL #	DESCRIPTION	PRICE
Consult	DA	Automatic motorized draft shield for analytical balances (factory installed)	Consult
Consult	DI	Automatic motorized draft shield for analytical balances, with integrated ionizer (factory installed)	Consult
Consult	TR	Certificate of compliance and full factory test report	Consult
Consult	IR	Additional RS-232, 25-Pin connection	Consult
156906	6971987	Power supply, 100-240V	140.00
156908	6900900	Cord, power 220V EU	30.00
Consult	IB	Bluetooth® wireless interface	Consult
Consult	IP	Additional RS-232, 9-Pin connection with PS2 port	Consult

## Standard Features

- Module design
- User configurable and custom designed to meet changing applications
- Meets advanced Pharma compliance including user/password management for security, audit trail function logs and integrated alibi memory
- Q-guide enables tasks and work (MSA display)
- Electrically conductive coating on glass panels of draft shield
- RS-232 and USB communication
- Easy cleaning by removing glass doors
- Underweigh hook included
- Draft shield

### Choice of display

- MSE-large 19 mm LCD display segments and easy menu system
- MSU-monochrome graphic display, positive click on keys to activate functions, Ethernet and SD Card Reader
- MSA-TFT color touchscreen, Ethernet and SD Card Reader options



The modular system offers you a choice of display and control units, weighing modules and draft shields

## Optional Features

- Bluetooth® Wireless technology

## Specifications

	3203S	2203S	2203P	1203S	5203S	5203P	623S	623P	323S	
<b>MSE*</b>	<b>Part#</b>	<b>109803</b>	<b>109804</b>	<b>109805</b>	<b>109806</b>	<b>156315</b>	<b>156316</b>	<b>109807</b>	<b>109808</b>	<b>109809</b>
	<b>List Price</b>	<b>\$7,385.00</b>	<b>\$7,135.00</b>	<b>\$6,885.00</b>	<b>\$6,235.00</b>	<b>\$8,535.00</b>	<b>\$8,135.00</b>	<b>\$4,835.00</b>	<b>\$4,235.00</b>	<b>\$4,135.00</b>
<b>MSU**</b>	<b>Part#</b>	<b>109810</b>	<b>109811</b>	<b>109812</b>	<b>109813</b>	<b>156313</b>	<b>156314</b>	<b>109814</b>	<b>109815</b>	<b>109816</b>
	<b>List Price</b>	<b>\$8,415.00</b>	<b>\$8,165.00</b>	<b>\$7,915.00</b>	<b>\$7,265.00</b>	<b>\$9,565.00</b>	<b>\$9,165.00</b>	<b>\$5,865.00</b>	<b>\$5,265.00</b>	<b>\$5,165.00</b>
<b>MSA***</b>	<b>Part#</b>	<b>109817</b>	<b>109818</b>	<b>109819</b>	<b>109820</b>	<b>156310</b>	<b>156312</b>	<b>109821</b>	<b>109822</b>	<b>109823</b>
	<b>List Price</b>	<b>\$8,930.00</b>	<b>\$8,680.00</b>	<b>\$8,430.00</b>	<b>\$7,780.00</b>	<b>\$10,980.00</b>	<b>\$9,680.00</b>	<b>\$6,380.00</b>	<b>\$5,780.00</b>	<b>\$5,680.00</b>
	<b>Capacity</b>	3200 g	2200 g	1010/2200 g	1200 g	5200 g	5200/2400/1200 g	620 g	150/300/620 g	320 g
	<b>Resolution</b>	<b>1 mg</b>	<b>1 mg</b>	<b>1/10 mg</b>	<b>1 mg</b>	<b>1 mg</b>	<b>5/2/1 mg</b>	<b>1 mg</b>	<b>1, 2, 5 mg</b>	<b>1 mg</b>
	<b>Weighing Modes</b>	Grams, Kilograms, Carat, Pounds, Ounces, Troy Ounce, Tael Hong Kong, Tael Singapore, Tael Taiwan, Grain, Pennyweight, Milligram, Parts per Pound, Tael China, Mommies, Austrian Carat, Tola, Baht, Mesghal, Ton, Pound:Ounces, Newton, Micrograms								
	<b>Operating Modes (*)</b>	Mass Unit Conversion, SQ min function, ISO-Cal function, Density determination (Buoyancy method only with MSE), Calculation, Averaging, Formulation, Percent weighing, Totalizing, Counting, Customized identification, Statistics, Time control function, Second tare memory, Over/Under Checkweighing								
	<b>Repeatability</b>	1/6 mg	1 mg	1/6 mg	0.7 mg	1 mg	1 mg	0.7 mg	1/2/4 mg	0.7 mg
	<b>Linearity</b>	5 mg	3 mg	5 mg	2 mg	5 mg	5 mg	2 mg	5 mg	2 mg
	<b>Stabilization Time</b>	1 second	1 second	1 second	1 second	1	1	0.8 seconds	0.8 seconds	0.8 seconds
	<b>Operating Temperature</b>	41° F to 104° F (+5° C to 40° C)								
	<b>Weighing Chamber (DE)</b>	8 x 8 x 7 in (from pan) (200 x 200 x 179 mm)								
	<b>Pan Size</b>	<b>5.5 x 5.5 in (140 x 140 mm)</b>								
	<b>Dimensions</b>	16 x 9.8 x 11 in (410 x 249 x 281.4 mm) (with manual draft shield)								
	<b>Weight (Approx.)</b>	17 lb								
	<b>Est. Ship Weight</b>	27 lb						25 lb		
	<b>Calibration Weight</b>	2000 g	2000 g	1000 g	1000 g	500 g	500 g	500 g	500 g	200 g
	<b>Power</b>	120V AC adapter (auto ranging)								
	<b>Warranty</b>	Two-year limited warranty								
	<b>Return Policy</b>	Sartorius Standard Policy - restock fee may apply								

\* MSE Large LCD display and easy to use menu system

\*\*MSU Monochrome graphic display, positive click on keys to activate functions, Ethernet and SD card reader

\*\*\*MSA TFT color touchscreen, Ethernet and SD card reader

## Part Number/Price

PART #	MODEL #	DESCRIPTION	PRICE
156315	MSE5203S-100-DE	5200 g x 0.001 g	\$8,535.00
156316	MSE5203P-100-DE	5200/2400/1200 g x 0.005/0.002/0.001 g	8,135.00
109803*	MSE3203S-100-DE	3200 g x 1 mg	7,385.00
109804*	MSE2203S-100-DE	2200 g x 1 mg	7,135.00
109805*	MSE2203P-100-DE	1010/2200 g x 1/10 mg	6,885.00
109806*	MSE1203S-100-DE	1200 g x 1 mg	6,235.00
109807*	MSE623S-100-DE	620 g x 1 mg	4,835.00
109808*	MSE623P-100-DE	150/300/620 g x 1/2/5 mg	4,235.00
109809*	MSE323S-100-DE	320 g x 1 mg	4,135.00
156313	MSU5203S-100-DE	5200 g x 0.001 g	9,565.00
156314	MSU5203P-100-DE	5200/2400/1200 g x 0.005/0.002/0.001 g	9,165.00
109810**	MSU3203S-100-DE	3200 g x 1 mg	8,415.00
109811**	MSU2203S-100-DE	2200 g x 1 mg	8,165.00
109812**	MSU2203P-100-DE	1010/2200 g x 1/10 mg	7,915.00
109813**	MSU1203S-100-DE	1200 g x 1 mg	7,265.00
109814**	MSU623S-100-DE	620 g x 1 mg	5,865.00
109815**	MSU623P-100-DE	150/300/620 g x 1/2/5 mg	5,265.00
156310	MSA5203S-100-DE	5200 g x 0.001 g	10,800.00
156312	MSA5203P-100-DE	5200/2400/1200 g x 0.005/0.002/0.001 g	9,680.00
109816**	MSU323S-100-DE	320 g x 1 mg	5,165.00
109817***	MSA3203S-100-DE	3200 g x 1 mg	8,930.00
109818 ***	MSA2203S-100-DE	2200 g x 1 mg	8,680.00
109819 ***	MSA2203P-100-DE	1010/2200 g x 1/10 mg	8,430.00
109820 ***	MSA1203S-100-DE	1200 g x 1 mg	7,780.0
109821 ***	MSA623S-100-DE	620 g x 1 mg	6,380.00
109822 ***	MSA623P-100-DE	150/300/620 g x 1/2/5 mg	5,780.00
109823 ***	MSA323S-100-DE	320 g x 1 mg	5,680.00

\*Large LCD display and easy to use menu system

\*\*Monochrome graphic display, positive click on keys to activate functions, Ethernet and SD card reader

\*\*\*TFT color touchscreen, Ethernet and SD card reader

## Options/Accessories

PART #	MODEL #	DESCRIPTION	PRICE
Consult	100	Fully automatic motorized leveling, one key touch, MSA MSU only (factory installed)	Consult
Consult	TR	Certificate of compliance and full factory test report	Consult
Consult	IR	Additional RS-232, 25-Pin connection	Consult
156906	6971987	Power supply, 100-240V	140.00
156908	6900900	Cord, power 220V EU	30.00
Consult	IB	Bluetooth® wireless interface	Consult
Consult	IP	Additional RS-232, 9-Pin connection with PS2 port	Consult

## Standard Features

- Fast stabilization time
- Module design
- User configurable and custom designed to meet changing applications
- Meets advanced Pharma compliance including user/password management for security, audit trail function logs and integrated alibi memory
- Q-guide enables tasks and work
- Electrically conductive coating on glass panels of draft shield
- RS-232 and USB communication
- Easy cleaning by removing glass doors
- Weigh underweigh included

### Choice of display

- MSE-large LCD display and easy menu system
- MSU-monochrome graphic display, positive click on keys to activate functions, Ethernet and SD Card Reader
- MSA-TFT color touchscreen, Ethernet and SD Card Reader options



The modular system offers you a choice of display and control units, weighing modules and draft shields

## Optional Features

- Bluetooth® Wireless technology

## Specifications

	1202S	2202S	4202S	6202P	6202S	8202S	10202S
<b>MSE*</b>	Part#	109832	109831	109830	109829	109828	109827
	List Price	\$3,095.00	\$3,455.00	\$3,815.00	\$3,965.00	\$4,435.00	\$5,045.00
<b>MSU**</b>	Part#	109842	109841	109840	109839	109838	109837
	List Price	\$4,125.00	\$4,485.00	\$4,845.00	\$4,995.00	\$5,465.00	\$6,075.00
<b>MSA***</b>	Part#	109852	109851	109850	109849	109848	109847
	List Price	\$4,640.00	\$5,000.00	\$5,360.00	\$5,510.00	\$5,980.00	\$6,590.00
Capacity	1200 g	2200 g	4200 g	1500/3000/6200 g	6200 g	8200 g	10200 g
Resolution	10 mg	10 mg	10 mg	10/20/50 mg	10 mg	10 mg	10 mg
Weighing Modes	Grams, Kilograms, Carat, Pounds, Ounces, Troy Ounce, Tael Hong Kong, Tael Singapore, Tael Taiwan, Grain, Pennyweight, Milligram, Parts per Pound, Tael China, Mommies, Austrian Carat, Tola, Baht, Mesghal, Ton, Pound:Ounces, Newton, Micrograms						
Operating Modes (*)	Mass Unit Conversion, SQ min function, ISO-Cal function, Density determination (Buoyancy method only with MSE), Calculation, Averaging, Formulation, Percent weighing, Totalizing, Counting, Customized identification, Statistics, Time control function, Second tare memory, Over/Under Checkweighing						
Repeatability	7 mg	7 mg	7 mg	7/20/1940 mg	7 mg	7 mg	7 mg
Linearity	20 mg	20 mg	20 mg	20 mg	20 mg	20 mg	20 mg
Stabilization Time	0.8 seconds	0.8 seconds	0.8 seconds	1 second	1 second	1 second	1 second
Operating Temperature	41° F to 104° F (+5° C to 40° C)						
Pan Size	8.1 x 8.1 in (206 x 206 mm)						
Dimensions	16 x 9.8 x 3.5 in (410 x 249 x 87.7 mm)						
Weight (Approx.)	16 lb						
Est. Shipping Weight	21 lb						
Calibration Weight	1 kg	2 kg	2 kg	5 kg	5 kg	5 kg	10 kg
Power	120V AC adapter (auto ranging)						
Warranty	Two-year limited warranty						
Return Policy	Sartorius Standard Policy - restock fee may apply						

\*MSE Large LCD display and easy to use menu system

\*\*MSU Monochrome graphic display, positive click on keys to activate functions, Ethernet and SD card reader

\*\*\*MSA TFT color touchscreen, Ethernet and SD card reader



## Specifications

	5201S	5202S	8201S	12201S	14202S	14202P	
<b>MSE*</b>	Part #	109835	156322****	109834	109833	156324	156327
	List Price	\$2,525.00	\$4,750.00	\$3,505.00	\$3,915.00	\$7,265.00	\$6,235.00
<b>MSU**</b>	Part #	109845	156321****	109844	109843	156323	156329
	List Price	\$3,555.00	\$5,925.00	\$4,535.00	\$4,945.00	\$8,295.00	\$7,265.00
<b>MSA***</b>	Part #	109855	156318****	109854	109853	156319	156320
	List Price	\$4,070.00	\$6,440.00	\$5,050.00	\$5,460.00	\$8,810.00	\$7,780.00
Capacity	5200 g	5200 g	8200 g	12200 g	14,200 g	14,200/7000/3500 g	
Resolution	100 mg	0.01 g	100 mg	100 mg	0.01 g	0.05/0.02/0.01 g	
Weighing Modes	Grams, Kilograms, Carat, Pounds, Ounces, Troy Ounce, Tael Hong Kong, Tael Singapore, Tael Taiwan, Grain, Pennyweight, Milligram, Parts per Pound, Tael China, Mommies, Austrian Carat, Tola, Baht, Mesghal, Ton, Pound:Ounces, Newton, Micrograms						
Operating Modes	Mass Unit Conversion, SQ min function, ISO-Cal function, Density determination (Buoyancy method only with MSE), Calculation, Averaging, Formulation, Percent weighing, Totalizing, Counting, Customized identification, Statistics, Time control function, Second tare memory, Over/Under Checkweighing						
Repeatability	50 mg	0.006 g	50 mg	50 mg	0.01 g	0.01/0.02/0.01 g	
Linearity	100 mg	0.01 g	100 mg	200 mg	0.03 g	0.05 g	
Stabilization Time	0.8 seconds	1 second	0.8 seconds	0.8 seconds	1 second	1 second	
Operating Temperature	41° F to 104° F (+5° C to 40° C)						
<b>Pan Size</b>	<b>8.1 x 8.1 in (206 x 206 mm)</b>						
Dimensions	16 x 9.8 x 3.5 in (410 x 249 x 87.7 mm)						
Weight (Approx.)	16 lb						
Est. Shipping Weight	21 lb						
Calibration Weight	5 kg	5000 g	5 kg	10 kg	10 kg	10 kg	
Power	120V AC adapter auto ranging						
Warranty	Two-year limited warranty						
Return Policy	Sartorius Standard Policy - restock fee may apply						

\*MSE Large LCD display and easy to use menu system

\*\*MSU Monochrome graphic display, positive click on keys to activate functions, Ethernet and SD card reader

\*\*\*MSA TFT color touchscreen, Ethernet and SD card reader

\*\*\*\*DR - Draft stainless steel shield

## Part Number/Price

PART #	MODEL #	DESCRIPTION	PRICE
156324	MSE14202S-100-DU	14,200 g x 0.01 g	\$7,265.00
156327	MSE14202P-100-DU	14,200/7000/3500 g x 0.05/0.02/0.01 g	6,235.00
109826*	MSE10202S-100-D0	10200 g x 10 mg	5,875.00
109827*	MSE8202S-100-D0	8200 g x 10 mg	5,045.00
109828*	MSE6202S-100-D0	6200 g x 10 mg	4,435.00
109829*	MSE6202P-100-D0	1500/3000/6200 g x 10/20/50 mg	3,965.00
156322	MSE5202S-100DR	5200 g x 0.01 g	4,750.00
109830*	MSE4202S-100-D0	4200 g x 10 mg	3,815.00
109831*	MSE2202S-100-D0	2200 g x 10 mg	3,455.00
109832*	MSE1202S-100-D0	1200 g x 10 mg	3,095.00
109833*	MSE12201S-100-D0	12200 g x 100 mg	3,915.00
109834*	MSE8201S-100-D0	8200 g x 100 mg	3,505.00
109835*	MSE5201S-100-D0	5200 g x 100 mg	2,525.00
156323	MSU14202S-100-D4	14,200 g x 0.01 g	8,295.00
156329	MSU14202P-100-DU	14,200/7000/3500 g x 0.05/0.02/0.01 g	7,265.00
109836**	MSU10202S-100-D0	10200 g x 10 mg	6,905.00
109837**	MSU8202S-100-D0	8200 g x 10 mg	6,075.00
109838**	MSU6202S-100-D0	6200 g x 10 mg	5,465.00
109839**	MSU6202P-100-D0	1500/3000/6200 g x 10/20/50 mg	4,995.00
156321	MSU5202S-100-DR	5200 g x 0.01 g	5,925.00
109840**	MSU4202S-100-D0	4200 g x 10 mg	4,845.00
109841**	MSU2202S-100-D0	2200 g x 10 mg	4,485.00
109842**	MSU1202S-100-D0	1200 g x 10 mg	4,125.00
109843**	MSU12201S-100-D0	12200 g x 100 mg	4,945.00
109844**	MSU8201S-100-D0	8200 g x 100 mg	4,535.00
109845**	MSU5201S-100-D0	5200 g x 100 mg	3,555.00
156319	MSA14202S-000-D0	14,200 g x 0.01 g	8,810.00
156320	MSA14202P-000-D0	14,200/7000/3500 g x 0.05/0.02/0.01 g	7,780.00
109846***	MSA10202S-00-D0	10200 g x 10 mg	7,420.00
109847***	MSA8202S-100-D0	8200 g x 10 mg	6,590.00
109848***	MSA6202S-100-D0	6200 g x 10 mg	5,980.00
109849***	MSA6202P-100-D0	1500/3000/6200 g x 10/20/50 mg	5,510.00
156318	MSA5202S-100-DR	5200 g x 0.01 g	6,440.00
109850***	MSA4202S-100-D0	4200 g x 10 mg	5,360.00
109851***	MSA2202S-100-D0	2200 g x 10 mg	5,000.00
109852***	MSA1202S-100-D0	1200 g x 10 mg	4,640.00
109853***	MSA12201S-100-D0	12200 g x 100 mg	5,460.00
109854***	MSA8201S-100-D0	8200 g x 100 mg	5,050.00
109855***	MSA5201S-100-D0	5200 g x 100 mg	4,070.00

\*Large LCD display and easy to use menu system

\*\*Monochrome graphic display, positive click on keys to activate functions, Ethernet and SD card reader

\*\*\*TFT color touchscreen, Ethernet and SD card reader

## Options/Accessories

PART #	MODEL #	DESCRIPTION	PRICE
Consult	TR	Certificate of compliance and full factory test report	Consult
Consult	IR	Additional RS-232, 25-Pin connection	Consult
156906	6971987	Power supply, 100-240V	140.00
156908	6900900	Cord, power 220V EU	30.00
Consult	IB	Bluetooth® wireless interface	Consult
Consult	IP	Additional RS-232, 9-Pin connection with PS2 port	Consult

## Standard Features

- All models have built-in internal calibration weights
- Automatic calibration at present time or temperature intervals
- RS-232C bidirectional interface port on all models
- High-contrast, blue backlit display
- Monolithic weigh cell provides stability and fast response



## Specifications

	CPA26P <sup>^</sup>	CPA225D <sup>^</sup>
<b>Part #</b>	<b>105570</b>	<b>105571</b>
<b>List Price</b>	<b>\$15,685.00</b>	<b>\$6,200.00</b>
Capacity	5/21 g	100/200 g
<b>Resolution</b>	<b>2/10 µg</b>	<b>0.01/0.1 mg</b>
Weighing Modes	Grams, Kilograms, Carats, Pounds, Ounces, Troy Ounces, Hong Kong taels, Singapore taels, Taiwanese taels, Grains, Pennyweights, Milligrams, Parts per Pound, Chinese taels, Mommies, Austrian carats, Tola, Baht, Menghal	
Operating Modes	Counting, Percent weighing, Animal weighing, Unit Toggle, Net total	
Repeatability	+/-4 g	+/-0.02/0.5/0.1 mg
Linearity	+/-8 g	+/-0.03/0.1/0.2 mg
Stabilization Time	10 seconds	6/3 seconds
Operating Temperature	50° F to 86° F (10° C to 30° C)	
Weighing Chamber	8 x 9.5 x 7 in (206 x 242 x 178 mm)	6.8 x 7.1 x 9.4 in (174 x 181 x 240 mm)
<b>Pan Size</b>	<b>Ø 2 in (50 mm)</b>	<b>Ø 3.1 in (80 mm)</b>
Dimensions	8.3 x 13.5 x 10.6 in (213 x 342 x 270 mm)	8.4 x 13.5 x 9.4 in (213 x 342 x 240 mm)
Weight (Approx.)	16.7 lb	16.7 lb
Est. Ship Weight	22 lb	23 lb
Calibration Weight	20 g	200 g
Power	120V AC adapter (Other adapters available by special order)	
Warranty	Two-year limited warranty	
Return Policy	Sartorius Standard Policy - restock fee may apply	

<sup>^</sup> Weighing Chamber

## Part Number/Price

PART #	MODEL #	DESCRIPTION	PRICE
105570	CPA26P	5/21 g x 2/10 µg	\$15,685.00
105571	CPA225D	100/200 g x 0.01/0.1 mg	6,200.00

## Options/Accessories

PART #	MODEL #	DESCRIPTION	PRICE
112261	YDP20-OCE	Data printers	\$995.00
50232	6971413	AC power	109.000
50232	6971413	AC power supply, printer	130.00
98038	YCC01-USBM2	Printer cable, 25-Pin to USB	263.00
31103	6906937	Paper, printer 5 rls/pk	38.00
31082	—	Density kit, Analytical (0.1 mg) software not included	890.00
152036	6971991	Power supply, no cord	72.00

## Standard Features

- Simple, color capacitive touch with swipe technology
- Monolithic and Strain Gauge Technology
- Aluminum Die-cast base, ABS housing
- Front level bubble
- Mini-USB
- Weigh Below hook

### Quintix & Secura Additional Features

- isoCAL / fully automatic, external calibration
- GLP conformance with built-in Time and Date

### Secura Additional Features

- Internal Calibration
- Opto-electronic leveling system
- Sqmin safety program
- Analytical draft support ring

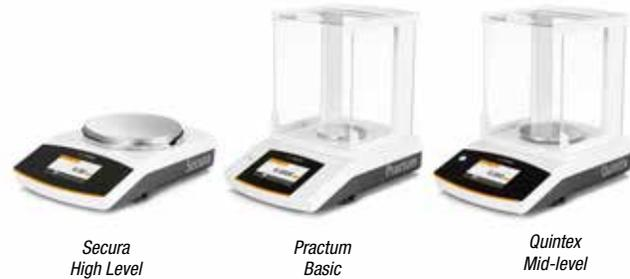

## Specifications

PRACTUM	124-1S	224-1S	213-1S	313-1S	-
Part Number	153983	153984	153985	153986	-
List Price	\$2,100.00	\$2,500.00	\$1,150.00	\$1,300.00	-
QUINTIX	124-1S	224-1S	213-1S	313-1S	513-1S
Part Number	153992	153993	153994	153995	153996
List Price	\$3,000.00	\$3,450.00	\$1,700.00	\$1,900.00	\$2,500.00
SECURA	124-1S	224-1S	213-1S	313-1S	513-1S
Part Number	154005	154006	154007	154008	154009
List Price	\$3500.00	\$3,950.00	\$2,200.00	\$2,400.00	\$3,000.00
Capacity	120g	220g	210g	310g	510 g
Resolution	1mg	1mg	0.001 g	001	0.001 g
Repeatability	+(-) 0.1mg	+(-) 0.1mg	0.001 g	0.001 g	0.001 g
Linearity (+/-)	+(-) 0.3mg (0.2 mg Secura Quintix)	+(-) 0.3mg (0.2 mg Secura & Quintix)	3 mg (2 mg Secura & Quintix)	3 mg (2 mg Secura & Quintix)	2 mg
External Calibration Weight	100g	200g			500 g
Weighing Modes	Gram, kilogram, carat, pound, ounce, troy ounce, Hong Kong, tael, Singapore Tael, Taiwan Tael, grain, pennyweights, milligram, parts per pound, China Tael, mommes, Atria carat, tola baht, mesghal and Newton				
Applications	Mass unit conversion, Counting, Percent weighing, Averaging,				
Display Type	LCD				
Operating Humidity	Less than 95% RH				
Operating Temperature	50°F to 86°F (10°C to 30°C)				
Stabilization Time (typical)	3 seconds				
Net Weight (kg/lb)	4.5 kg (11 lb)				
Pan Size/ Type	90 mm (3.5") diameter pan, stainless steel		120 mm (4.75 in) diameter pan, stainless steel		
Weighing Chamber Height	209 mm (7.9 in)				
Dimensions (WxDxH)					
Power Requirements	10-20V				
AC Power Requirements	AC adapter, 115V-240V,				
Frequency	50-60 Hz				
Optional Accessories	Calibration weights, RS232 Interface Cable				
Warranty	3 Year Manufacture Warranty				

Sartorius

# Practum/Quintix/Secura

Analytical

## Part Number/Price

PART NUMBER	MODEL	DESCRIPTION	PRICE
153983	Practum 124-1S	120 g x 0.1 mg	\$2,100.00
153992	Quintix 124-1S	120 g x 0.1 mg	3,090.00
154005	Secura 124-1S	120 g x 0.1 mg	3,600.00
153984	Practum 224-1S	220 g x 0.1 mg	2,500.00
153993	Quintix 224-1S	220 g x 0.1 mg	3,520.00
154006	Secura 224-1S	220 g x 0.1 mg	3,995.00
153985	Practum 213-1S	210 g x 0.001 g	1,300.00
153994	Quintix 213-1S	210 g x 0.001 g	1,830.00
154007	Secura 213-1S	210 g x 0.001 g	2,200.00
153986	Practum 313-1S	310 g x 0.001 g	1,500.00
153995	Quintix 313-1S	310 g x 0.001 g	1,955.00
154008	Secura 313-1S	310 g x 0.001 g	2,400.00
153996	Quintix 513-1S	510 g x 0.001 g	2,650.00
154009	Secura 513-1S	510 g x 0.001 g	3,000.00

## Options/Accessories

PART #	MODEL #	DESCRIPTION	PRICE
154749	6971790	AC adapter, 110-240V, six power plugs	\$100.00
155847	YCC04-D09	Adapter cable, USB to RS-232	46.00

BALANCES

www.ricelake.com | Phone: 800-472-6703

RICE LAKE

## Standard Features

- Simple, color capacitive touch with swipe technology
- Monolithic and Strain Gauge Technology
- Aluminum Die-cast base, ABS housing
- Front level bubble
- Mini-USB
- Weigh Below hook

### Quintix & Secura Additional Features

- isoCAL / fully automatic, external calibration
- GLP conformance with built-in Time & Date
- Time & Date

### Secura Additional Features

- Internal Calibration
- Opto-electronic leveling system
- Sqmin safety program
- Analytical draft support ring

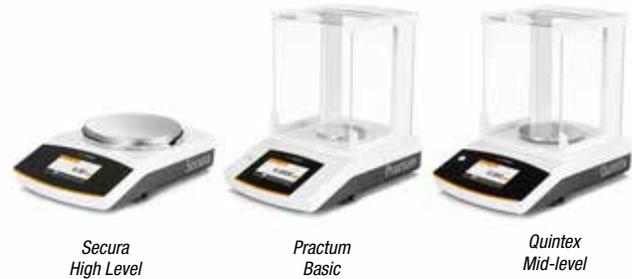

## Specifications

PRACTUM	612-1S	1102-1S	2102-1S	N/A	N/A	5101-1S	5100-1S
Part Number	153987	153988	153989	N/A	N/A	153991	153990
List Price	\$995.00	\$1,100.00	\$1,295.00	N/A	N/A	\$1,095.00	\$900.00
QUINTIX	612-1S	1102-1S	2102-1S	3102-1S	5102-1S	5101-1S	5100-1S
Part Number	153998	153999	154000	154001	154003	154004	154002
List Price	\$1,545.00	\$1,750.00	\$1,955.00	\$2,165.00	\$2,680.00	\$1,545.00	\$1,235.00
SECURA	N/A	1102-1S	2102-1S	3102-1S	5102-1S	N/A	N/A
Part Number	N/A	154010	154011	154012	154013	N/A	N/A
List Price	N/A	\$2,100.00	\$2,500.00	\$2,700.00	\$3,100.00	N/A	N/A
Capacity	610 g	1100 g	2100 g	3100 g	5100 g	5100 g	5100 g
Resolution	0.01 g	0.01 g	0.01 g	0.01 g	0.01 g	0.1 g	1.0 g
Repeatability	+(-) 10 mg	+(-) 10 mg	+(-) 10 mg	+(-) 10 mg	+(-) 10 mg	0.1 g	1.0 g
Linearity (+/-)	30 mg (20 mg Quintix & Secura)	30 mg (20 mg Quintix & Secura)	30 mg (20 mg Quintix & Secura)	20 mg	20 mg	0.3 g (0.2 g Quintix)	3.0 g (2.0 g Quintix)
External Calibration Weight	500 g	1000 g	2000g		5000 g		
Weighing Modes	Gram, kilogram, carat, Pound, Ounce, troy Ounce, Hong Kong, tael, Singapore Tael, Taiwan Tael, grain, pennyweights, milligram, parts per Pound, China Teal, mommes, Atria carat, tola baht, mesghal and Newton						
Applications	Mass unit conversion, Counting, Percent weighing, Averaging,						
Display Type	LCD						
Operating Humidity	Less than 95% RH						
Operating Temperature	50° F to 86° F (10° C to 30° C)						
Operating Temperature	41° F to 104° F (5° C to 40° C)						
Stabilization Time (typical)	3 seconds						
Net Weight (kg/lb)	9lb (4.5kg)						
Pan Size/ Type	<b>7 in (180 mm) diameter pan, stainless steel</b>						
Dimensions (WxDxH)	14.1 x 8.5 x 12.6 in (360 x 216 x 320 mm)						
AC Power Requirements	AC adapter, 115V-240V						
Frequency	50-60 Hz						
Warranty	<b>Two-year limited warranty</b>						

Sartorius

# Practum/Quintix/Secura

Precision

## Part Number/Price

PART NUMBER	MODEL	DESCRIPTION	PRICE
153987	Practum 612-1S	610 g x 0.01 g	\$995.00
153998	Quintix 612-1S	610 g x 0.01 g	1,545.00
153988	Practum 1102-1S	1100 g x 0.01 g	1,100.00
153999	Quintix 1102-1S	1100 g x 0.01 g	1,750.00
154010	Secura 1102-1S	1100 g x 0.01 g	2,100.00
153989	Practum 2102-1S	2110 g x 0.01 g	1,295.00
154000	Quintix 2102-1S	2110 g x 0.01 g	1,955.00
154011	Secura 2102-1S	2110 g x 0.01 g	2,500.00
154001	Quintix 3102-1S	3100 g x 0.01 g	2,165.00
154012	Secura 3102-1S	3100 g x 0.01 g	2,700.00
154003	Quintix 5102-1S	5100 g x 0.01 g	2,680.00
154013	Secura 5102-1S	5100 g x 0.01 g	3,100.00
153991	Practum 5101-1S	5100 g x 0.1 g	1,095.00
154004	Quintix 5101-1S	5100 g x 0.1 g	1,545.00
153990	Practum 5100-1S	5100 g x 1.0 g	900.00
154002	Quintix 5100-1S	5100 g x 1.0 g	1,235.00

## Options/Accessories

PART #	MODEL #	DESCRIPTION	PRICE
154749	6971790	AC adapter, 110-240V, six power plugs	\$100.00
155847	YCC04-D09	Adapter cable, USB to RS-232	46.00

BALANCES

www.ricelake.com | Phone: 800-472-6703

RICE LAKE

## Standard Features

- User-friendly operation
- Basic applications
- Monolithic weighing systems
- Aluminum Die-cast base, ABS housing
- Front level bubble
- RS-232 standard
- Below balance weighing



## Specifications

	ENTRIS64-1S <sup>^</sup>	ENTRIS124-1S <sup>^</sup>	ENTRIS224-1S <sup>^</sup>	ENTRIS153-1S <sup>^</sup>	ENTRIS323-1S <sup>^</sup>	ENTRIS423-1S <sup>^</sup>
<b>Part#</b>	<b>160679</b>	<b>160680</b>	<b>160681</b>	<b>160682</b>	<b>160683</b>	<b>160684</b>
<b>List Price</b>	<b>\$1,575.00</b>	<b>\$1,890.00</b>	<b>\$2,100.00</b>	<b>\$945.00</b>	<b>\$1,105.00</b>	<b>\$1,315.00</b>
Capacity	60 g	120 g	220 g	150 g	320 g	420 g
<b>Readability</b>	<b>0.0001 g</b>	<b>0.0001 g</b>	<b>0.0001 g</b>	<b>0.001 g</b>	<b>0.001 g</b>	<b>0.001 g</b>
Repeatability	+(-) 0.0001 g	+(-) 0.0001 g	+(-) 0.0001 g	+(-) 0.001 g	+(-) 0.001 g	+(-) 0.001 g
Linearity (+/-)	+(-) 0.0002 g	+(-) 0.0002 g	+(-) 0.0002 g	+(-) 0.002 g	+(-) 0.002 g	+(-) 0.00 g
<b>External Calibration Weight</b>	<b>50 g</b>	<b>100 g</b>	<b>200 g</b>	<b>100 g</b>	<b>200 g</b>	<b>200 g</b>
Weighing Modes	Gram, kilogram, carat, Pound, Ounce, troy Ounce, Hong Kong, tael, Singapore Tael, Taiwan Tael, grain, pennyweights, milligram, parts per Pound, China Teal, mommes, Austrian carat, tola baht, mesghal, tons, Pounds:Ounces, and Newton					
Applications	Weighing, Density, Percentage, Counting, Mass unit conversion					
Display Type	Backlit LCD White, 15 mm digits					
Operating Humidity	15% to 80% for temperatures up to 31° C					
Operating Temperature	50° F to 86° F (10° C to 30° C)					
Stabilization Time (typical)	2.5 seconds			1.3 seconds	1.1 seconds	1.0 seconds
Net Weight (kg/lbs)	5.4 kg (12 lb)	5.4 kg (12 lb)	5.4 kg (12 lb)	5 kg (11 lb)	5.4 kg (12 lb)	5.4 kg (12 lb)
Pan Size/ Type	90 mm (3.5 in) diameter pan, stainless steel			150 mm (4.5 in) diameter pan, stainless steel		
Dimensions (W x D x H)	230 x 303 x 330 mm (9.1 x 11.9 x 13 in)			230 x 303 x 136 mm (9.1 x 11.9 x 5.4 in)		
AC Power Requirements	AC adapter, 115V-240V, US plug					
Warranty	Two-year limited warranty					

<sup>^</sup>Weighing Chamber



## Specifications

	ENTRIS623-1S <sup>^</sup>	ENTRIS822-1S	ENTRIS2202-1S	ENTRIS3202-1S	ENTRIS4202-1S	ENTRIS-6202-1S
<b>Part #</b>	<b>160685</b>	<b>160686</b>	<b>160687</b>	<b>160688</b>	<b>160689</b>	<b>160690</b>
<b>List Price</b>	<b>\$1,525.00</b>	<b>\$840.00</b>	<b>\$1,000.00</b>	<b>\$1,210.00</b>	<b>\$1,365.00</b>	<b>\$1,575.00</b>
Capacity	620 g	820 g	2200 g	3200 g	4200 g	6200 g
<b>Readability</b>	<b>0.001 g</b>	<b>0.01 g</b>	<b>0.01 g</b>	<b>0.01 g</b>	<b>0.01 g</b>	<b>0.01 g</b>
Repeatability	+(-) 0.001 g	+(-) 0.01 g	+(-) 0.01 g	+(-) 0.01 g	+(-) 0.01 g	+(-) 0.01 g
Linearity (+/-)	+(-) 0.002 g	+(-) 0.03 g	+(-) 0.03 g	+(-) 0.03 g	+(-) 0.03 g	+(-) 0.03 g
<b>External Calibration Weight</b>	<b>500 g</b>	<b>500 g</b>	<b>2000 g</b>	<b>2000 g</b>	<b>2000 g</b>	<b>5000 g</b>
Weighing Modes	Gram, kilogram, carat, Pound, Ounce, troy Ounce, Hong Kong, tael, Singapore Tael, Taiwan Tael, grain, pennyweights, milligram, parts per Pound, China Teal, mommes, Austrian carat, tola baht, mesghal, tons, Pounds:Ounces, and Newton					
Applications	Weighing, Density, Percentage, Counting, Mass unit conversion					
Display Type	Backlit LCD White, 15 mm digits					
Operating Humidity	15% to 80% for temperatures up to 31° C					
Operating Temperature	50° F to 86° F (10° C to 30° C)					
Stabilization Time (typical)	1.0 seconds		1.5 seconds			
Net Weight (kg/lbs)	5.4 kg (12 lb)	4.5 kg (9 lb)	5.4 kg (12 lb)	5.4 kg (12 lb)	5.4 kg (12 lb)	5.4 kg (12 lb)
Pan Size/ Type	90 mm (3.5 in) diameter pan, stainless steel	150 mm (5.9 in) pan, stainless steel	230 x 303 x 91 mm (9.1 x 11.9 x 3.6 in)			
Dimensions (WxDxH)	230 x 303 x 330 mm (9.1 x 11.9 x 13 in)	230 x 303 x 87 mm (9.1 x 11.9 x 3.4 in)	230 x 303 x 136 mm (9.1 x 11.9 x 5.4 in)			
AC Power Requirements	AC adapter, 115V-240V, US plug					
Warranty	Two-year limited warranty					

<sup>^</sup>Weighing Chamber

## Specifications

	ENTRIS2201-1S	ENTRIS5201-1S	ENTRIS8201-1S
<b>Part #</b>	<b>160691</b>	<b>160692</b>	<b>160693</b>
<b>List Price</b>	<b>\$850.00</b>	<b>\$1,000.00</b>	<b>\$1,100.00</b>
Capacity	2200 g	5200 g	8200 g
<b>Readability</b>	<b>0.1 g</b>	<b>0.1 g</b>	<b>0.1 g</b>
Repeatability	+(-) 0.1 g	+(-) 0.1 g	+(-) 0.1 g
Linearity (+/-)	+(-) 0.3 g	+(-) 0.3 g	+(-) 0.3 g
<b>External Calibration Weight</b>	<b>2000 g</b>	<b>5000 g</b>	<b>5000 g</b>
Weighing Modes	Gram, kilogram, carat, Pound, Ounce, troy Ounce, Hong Kong, tael, Singapore Tael, Taiwan Tael, grain, pennyweights, milligram, parts per Pound, China Teal, mommes, Austrian carat, tola baht, mesghal, tons, Pounds:Ounces, and Newton		
Applications	Weighing, Density, Percentage, Counting, Mass unit conversion		
Display Type	Backlit LCD White, 15 mm digits		
Operating Humidity	15% to 80% for temperatures up to 31° C		
Operating Temperature	50° F to 86° F (10° C to 30° C)		
Stabilization Time (typical)	1.0 seconds	1.5 seconds	
Net Weight (kg/lbs)	5.4 kg (12 lb)	5.4 kg (12 lb)	5.4 kg (12 lb)
Pan Size/ Type	230 x 303 x 91 mm (9.1 x 11.9 x 3.6 in)		
Dimensions (WxDxH)	230 x 303 x 330 mm (9.1 x 11.9 x 13 in)	230 x 303 x 87 mm (9.1 x 11.9 x 3.4 in)	230 x 303 x 136 mm (9.1 x 11.9 x 5.4 in)
AC Power Requirements	AC adapter, 115V-240V, US plug		
Warranty	Two-year limited warranty		

<sup>^</sup>Weighing Chamber

### Part Number/Price

PART #	MODEL #	DESCRIPTION	PRICE
160679	ENTRIS64-1S	60 g x 0.1 mg	\$1,575.00
160680	ENTRIS124-1S	120 g x 0.1 mg	1,890.00
160681	ENTRIS224-1S	220 g x 0.1 mg	2,100.00
160682	ENTRIS153-1S	150 g x 0.001 g	945.00
160683	ENTRIS323-1S	320 g x 0.001 g	1,105.00
160684	ENTRIS423-1S	420 g x 0.001 g	1,315.00
160685	ENTRIS623-1S	620 g x 0.001 g	1,525.00
160686	ENTRIS823-1S	820 g x 0.001 g	840.00
160687	ENTRIS2202-1S	2200 g x 0.01 g	1,000.00
160688	ENTRIS3202-1S	3200 g x 0.01 g	1,210.00
160689	ENTRIS4202-1S	4200 g x 0.01 g	1,365.00
160690	ENTRIS6200-1S	6200 g x 0.01 g	1,575.00
160691	ENTRIS2201-1S	2200 g x 0.1 g	895.00
160692	ENTRIS5201-1S	5200 g x 0.1 g	1,050.00
160693	ENTRIS8201-1S	8200 g x 0.1 g	1,155.00

### Options/Accessories

PART #	MODEL #	DESCRIPTION	PRICE
112261	YDP20-OCE	Data Printer	\$995.00
31103	6906937	Paper rolls, one roll	38.00
31106	6906918	Ink ribbon cassette	44.00
31071	YRB05Z	Battery Pack, external rechargeable	625.00
155805	YCC01-USBM2	Data Cable RS-232/USB	130.00
154749	6971790	AC Adapter with interchangeable plugs	100.00

**Standard Features**

- Converts serial data such as barcode reader or scale into keyboard input to software program
- Works with PC and MAC
- Requires no driver installation (identifies itself as additional HID keyboard)
- Cable draws power from USB port (no external power supply needed)
- Test cable to be connected with adapter scale cable or connector
- Bluetooth version allows Bluetooth connection to devices like iPad, Playbook, Android tablets and smart cell phones

**Specifications**

**Baud Rate:**

9600

**Color:**

Black

**Cable Length:**

74 in (1880 mm)

**Bluetooth Cable Length:**

16 in (406 mm)

**Power:**

USB power, no external power supply

**Host:**

PC and MAC compliant

**Connection:**

DB9 male connector, Pin 2 RX, Pin 3 TX and Pin 5 Ground USBA connector



**Part Number/Price**

PART #	DESCRIPTION	WEIGHT	PRICE
119919	RS-232/USB Serial Cable	1 lb	\$185.00
132452	RS-232/USB Serial Cable plus Bluetooth	1 lb	260.00

**Options/Accessories**

PART #	DESCRIPTION	PRICE
119064	Slimline Null Modem, gender changer DB9 female to female	\$10.50
22436	Blunt-end to DB9 female, straight cable	55.00
50749	DB9 female to DB9 female	55.00
130789	Null Model DB9 adapter female to male	12.00

# go-between

Data Capture and Storage

## Standard Features

- LED on board for testing data transmission
- Captures data and stores it on a USB flash drive up to 8GB (not included)
- Transfer data to your PC using the USB flash drive

## Specifications

**Baud Rate:**

9600

**Data Bits:**

8

**Parity:**

None

**Power:**

Requires 5VDC

**Customer Supplied:**

Power and USB flash drive

**Industrial Enclosure Option:**

7.5 x 7.5 x 4.5 in (19 x 19 x 12 mm)  
Latch for lock

**Desktop Model:**

DB 9-Pin Male

**Warranty:**

One-year limited warranty

**Text file examples (actual text will be dependent on transmitted file)**

```
02:50PM
11/13/2012
GROSS          58 lb

02:50PM
11/13/2012
GROSS          68 lb
```



## Part Number/Price

PART #	DESCRIPTION	PRICE
153265	go-between board, requires 5 Volts	\$410.00
153266	go-between industrial enclosure, requires 5 Volts	500.00
153267	go-between desk enclosure, power supply included	500.00

## Options/Accessories

PART #	DESCRIPTION	PRICE
154797	Adapter, power 5VDC 2A 90-264VAC, U.S. plug, UL/CUL	\$35.00
125077	USB flash drive, 1 GB	20.00
130789	Null Model DB9 adapter female to male	12.00
119064	Null modem adapter, DB9 F/F	10.50
50764	Straight cable, DB9 F/F	48.00
66535	Null modem DB9 F/F	45.00
22436	DB9 cable to blunt end	55.00
15493	Cable four-conductor	1.25/ft

# Standard Balance Slab

Kasota Stone



83779

*Reduces vibration and shock, ideal where tables will not fit*

## Part Number/Price

PART #	DESCRIPTION	PRICE
<b>Standard Balance Slab, Kasota Stone</b>		
83779	15 in x 20 in x 3 in 100 lb	\$450.00
<b>Clean Room Table</b>		
83780	24 in x 35 in x 32 in 600 lb	2,700.00
<b>Standard Balance Table, Kasota Stone</b>		
83778	24 in x 35 in x 32 in 700 lb	1,200.00
<b>Anti-Vibration Pad</b>		
75263	Anti-vibration pad 4 x 4 1/2 in. thick	15.00

## Clean Room Table

Granite



83789

*Mass, Density and Vibration damping properties for most applications. (Four damping pads included)*

## Standard Balance Table

Kasota Stone



83778

*Provides the most stable surface possible for precision instruments. Legs are reinforced with support pipe.*

## Anti-Vibration



75263

## Scoops



33447



33455



33451



33454



33456

## Part Number/Price

PART #	DESCRIPTION	PRICE
33455	Aluminum, 1.5 x 2.0 in (3.8 x 5.1 cm)	\$25.00
33446	Polypropylene, 12 x 6 x 2.75 in (304 x 152 x 70 mm)	37.00
33447	Stainless steel, 12 x 6 x 2.75 in (304 x 152 x 70 mm)	88.00
33448	Polypropylene Maxi-scoop, 10 in (254 mm) diameter x 2.5 in (70 mm) deep with pouring spout	40.00
33456	Gold, 2.25 x 3.0 in (5.7 x 7.6 cm)	25.00
33454	Black, aluminum 4.0 x 3.5 in (10.2 x 8.9 cm)	26.00
33451	Polypropylene Maxi-scoop	35.00
97250	Stainless steel scoop 11.9 x 7.4 x 1.7 in	50.00
100292	Stainless steel scoop 17.2 x 11 x 3.4 in	62.00

# Prove™ Statistical Printer

## Specifications

**Printing System:**

Direct thermal line head

**Max. Characters (per line):**

48, 32, (24 default)

**Character Matrix:**

24 x 8, 24 x 12 or 24 x 16

**Character Size:**

0.1 x 0.08 in, 0.1 x 0.06 in, or 0.1 x 0.04 in  
 (approx. 13, 17 or 25 cpi) horizontal dot pitch  
 3 x 2 mm, 3 x 1.5 mm, or 3 x 1 mm  
 (approx. 13, 17 or 25 cpi) horizontal dot pitch:

**Horizontal Dot Pitch:**

0.005 in (0.125 mm) approximately 200 dpi

**Vertical Dot Pitch:**

0.005 in (0.125 mm)

**Text Line Composition:**

24 x 384 dots

**Printing Width:**

1.9 in (48 mm)

**Average Print Speed:**

10 lines per second, max.

**Dimensions:**

3.4 x 5.9 x 2.2 in (85.5 x 150 x 55 mm)

**Weight:**

400 g approx. (includes batteries and paper)

**Paper Width:**

2.3 in (58 mm)

**Paper Capacity:**

1.8 in diameter, 1 in standard printer  
 45 mm diameter, 25 m standard printer

**Character Set:**

ASCII

**Country Codes:**

USA

**Data Format:**

RS-232C (8 Data, 1 Stop, No Parity).

**Connector**

6-way RJ12 socket

**Baud Rate:**

9600

**Handshaking Hardware:**

(CTS line) or Software (XON/XOFF)

**Buffer Size:**

5 Kbytes

**Environmental Changes:**

Operating Range: 32° F to 120° F (0° C to 50° C)  
 Storage Range: -4° F to 140° F (-20° C to 60° C)  
 Charging Range: 32° F to 113° F (10° C to 45° C)

**Charge Life:**

Approximately 6000 lines (18 m) of continuous printing

**Warranty:**

One-year limited warranty



## Standard Features

- Statistical Printer – Rice Lake Balances TA, TP, Equipoise, , A&D GF balance, CW90 Checkweigher
- Statistical information provided: MAX, MIN, AVERAGE, Standard deviation, and Coefficient of Variable
- Easy-Load paper feature
- RS-232 interface
- Maintenance-free
- Ultra-Compact and light weight
- High reliability line head mechanism
- Low power mode
- Range of configurable options
- Low Profile paper lid and range of mounting options available
- Rechargeable NiMH batteries
- Multi-ranging AC with changeable plugs

## Part Number/Price

PART #	DESCRIPTION	PRICE
158056	Prove statistical printer, 110-240VAC with universal AC adapter	\$715.00

## Options/Accessories

PART #	DESCRIPTION	PRICE
130789	Null modem adapter, DBF/M (required for Equipoise)	\$12.00
158583	RJ11 to 5-Pin DIN (required for TP balance)	65.00
41279	RS-232 cable, 25-Pin 9-Pin	65.00

# Belt Scales

## Table of Contents

<b>311M</b> .....	<b>162</b>
Medium to Heavy Capacity Belt Scale	
<b>221DB</b> .....	<b>163</b>
Medium to Heavy Capacity Belt Scale	
<b>Belt Scale Integrator</b> .....	<b>164</b>
<b>BCi</b> .....	<b>165</b>
Weigh Frames	
<b>Belt Scale Accessories</b> .....	<b>166</b>
<b>Belt Scale Questionnaire</b> .....	<b>168</b>

**ESPAÑOL** | Visit [ricelake.com/spanish](http://ricelake.com/spanish)  
to see all RLWS materials  
available in Spanish

Product names, logos, brands, and other trademarks featured  
or referred to within this publication are the property of their respective trademark holders.

# 311M

Medium to Heavy Capacity Belt Scale

## Specifications

**Conveyor Width:**  
20 in to 50 in

**Capacity:**  
1500 tons/hr

**Belt Speed:**  
400 feet/minute

**Inclination:**  
Maximum 12 degrees

**Material:**  
Powder coated mild steel

**System Accuracy:**  
0.5-1%

**Load Cell:**  
RL1250: 50kg, 100kg, 250kg

**Options:**  
Galvanized or stainless construction

**Warranty**  
One-year limited warranty

## Standard Features

- Semi-modular weigh frame design
- Minimum modification to conveyor required
- Weigh frame without moving parts
- Fits standard conveyors - mounts with four bolts
- Requires weigh frame cutting for proper fit

## Applications

- Mining, quarries, bulk material blending, process control applications, retrofit applications

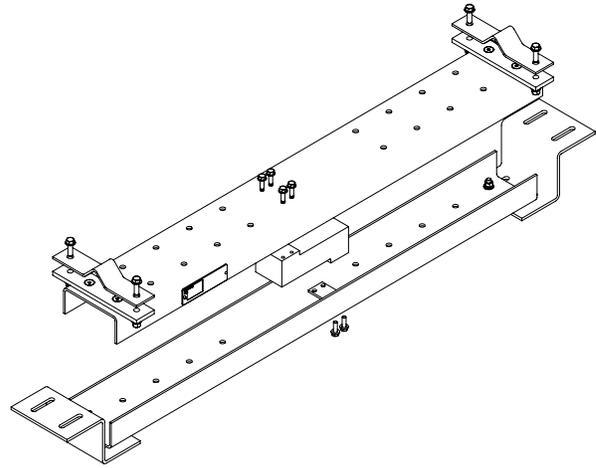

## Part Number/Price

PART #	DESCRIPTION	EST. SHIP WEIGHT	PRICE
163296	311M Belt Scale with 50 kg load cell	125 lb	\$895.00
163297	311M Belt Scale with 100 kg load cell	125 lb	895.00
163298	311M Belt Scale with 250 kg load cell	125 lb	895.00



# 221DB

Medium to Heavy Capacity Belt Scale

## Specifications

**Conveyor Width:**

20 in to 72 in

**Capacity:**

3300 tons/hr

**Max Belt Speed:**

800 feet/minute

**Inclination:**

Maximum 25 degrees

**Material:**

Powder coated mild steel

**System Accuracy:**

0.5-1%

**Load Cell:**

RLHBB: 50kg, 100kg, 200kg

**Junction Box:**

JB4SS

**Options:**

Galvanized or stainless construction

**Warranty**

One-year limited warranty

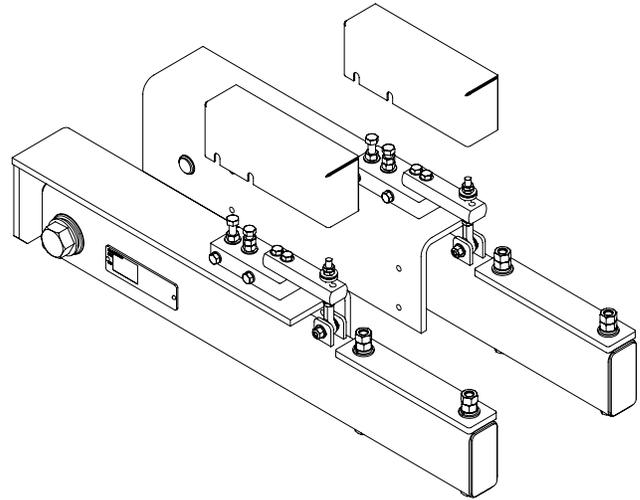

## Part Number/Price

PART #	DESCRIPTION	EST. SHIP WEIGHT	PRICE
163292	221DB Belt Scale with 50 kg load cells	143 lb	\$2,695.00
163293	221DB Belt Scale with 100 kg load cells	143 lb	2,695.00
163294	221DB Belt Scale with 200 kg load cells	143 lb	2,695.00

## Standard Features

- Weigh frame is mounted on outside of conveyor
- Minimum modification to conveyor are required
- Service friendly
- Friction free pivot supports
- Two support beams
- Fits standard conveyors - mounts with four bolts per assembly

## Applications

- Medium/Heavy capacity belt scale

# Belt Scale Integrator

## Specifications: 920i Integrator

### Power:

Line voltages: 115 or 230 VAC,  
Frequency: 50 or 60 Hz

### Power Consumption:

340 mA, maximum at 115 VAC (26W)  
240 mA at 230 VAC (26W)

### Excitation Voltage:

10 ± VDC, 16 x 350 Ω or 32 x 700 Ω load cells per A/D card

### Analog Signal Input Range:

-10 mV to +45 mV

### Analog Signal Sensitivity:

0.3 μV/graduation minimum at 7.5 Hz  
1.0 μV/graduation typical at 120 Hz  
4.0 μV/graduation typical at 960 Hz  
A/D Sample Rate: 7.5 to 960 Hz, software selectable

### Resolution:

Internal resolution: 8 million counts  
Weight display resolution: 9,999,999  
System Linearity: ± 0.01% full scale

### Digital I/O:

Six I/O channels on CPU board; optional 24-channel I/O expansion boards available

### Circuit Protection:

RFI, EMI, ESD protection

### Serial Ports:

Four ports on CPU board support up to 115,200 bps; optional dual-channel serial expansion boards available  
Port 1: ..... Full duplex RS-232  
Port 2: ..... RS-232 with CTS/RTS;  
PS/2 keyboard interface via DB-9 connector  
Port 3: ..... Full duplex RS-232, 20 mA output  
Port 4: ..... Full duplex RS-232, 2-wire RS-485, 20 mA output

### Display:

4.6 W x 3.4 in H (116 W x 86 mm H),  
320 x 240 pixel VGA Liquid Crystal Display (LCD) module with adjustable contrast

### Keyboard:

27-key membrane panel, tactile feel, PS/2 port for external keyboard connection

### Operating Temperature:

14° F to 104° F (-10° C to 40° C)  
Industrial: 14° F to 122° F (-10° C to 50° C)

### Dimensions:

Universal: 10.5 W x 10.9 H x 4.5 in D (266 W x 215 H x 114 mm D)  
Deep Universal: 10.75 W x 10.75 H x 5.4 in D (273 W x 273 H x 137 mm D)

### Weight:

Panel Mount enclosure: 8.5 lb (3.9 kg)  
Deep Universal: 11 lb (5.0 kg)

### Rating/Material:

NEMA 4X/IP66, stainless steel

### Warranty:

Two-year limited warranty on integrator and load cells

### Approvals:

CE marked;  
UL & C-UL listed (Universal, Deep & Wall Mount Enclosure)  
Custom Wall Mount approved for 508A (Optional)  
Panel Mount UL recognized



920i® Integrator

## APPROVALS



## Standard Features

- Large 4.6 in W x 3.4 in H 320 x 240 pixel back-lit LCD graphical display
- NEMA 4X/IP66 stainless steel display enclosure
- Four bidirectional communication ports
- Rate and speed time displayed by the hour, minute or second
- Measurement displayed in feet or meters
- Unit of rate displayed in tons, pounds, kilograms, metric tons or long tons
- Digital I/O for totalizer
- Analog outputs optional
- Alarm outputs optional
- For added security, integrator has the ability to be password protected
- Optional Communication protocol cards include ControlNet, Rockwell Automation's DeviceNet, Rockwell Automation's Remote I/O, Rockwell Automation's EtherNet IP, Profibus DP, 0-10 VAC or 4-20 mA analog output, Ethernet TCP/IP,
- Standard Communication RS-232, RS-485, 20 mA current loop
- Built in support for ticket printing

## Part Number/Price

PART #	DESCRIPTION	PRICE
<b>Integrators</b>		
107615	Belt scale integrator with UPS 115VAC	2,395.00
107616	Belt scale integrator with UPS 230VAC	2,395.00
120550	Belt scale integrator with deep enclosure, 2 slot expansion, EtherNet IP for A-B, 115 V	3,395.00
120551	Belt scale integrator with deep enclosure, 2 slot expansion, EtherNet IP for A-B, 230 V	3,395.00
95214	Belt scale integrator 115VAC, deep enclosure	2,295.00
95215	Belt scale integrator 230VAC, deep enclosure	2,295.00
150811	Belt scale integrator with deep enclosure, 2 slot expansion, analog output	2,945.00

Please complete the Belt Scale Questionnaire on page 168 to obtain a firm quote

# BCi

## Weigh Frames

### Specifications:

**Conveyor Widths:**

18 to 72 in

**Capacity:**

Up to 10,000 tph

**Belt Speed:**

Up to 1,200 fpm

**Accuracy Guidelines:**

Single-two idler system: 0.5%-1% total error

Three-four idler system: <0.5% total error

**System Accuracy:**

Guidelines assume clean belt with automatic tensioning system. Accuracy guidelines are typical. System accuracy may vary depending on environmental influences.

**Applications:**

Mining, quarries, bulk material blending, process control applications, utilities, truck/ barge/rail loading, retrofit applications



*Note: Idler not included and customer is responsible for mounting idler to weigh frame*

### Part Number/Price

PART #	DESCRIPTION	ESTIMATED BELT WIDTH	CAPACITY	PRICE
95205	20 in weigh frame	14 in	500 lb	\$1,995.00
95206	22 in weigh frame	16 in	500 lb	1,995.00
94968	24 in weigh frame	18 in	500 lb	1,995.00
95207	26 in weigh frame	20 in	500 lb	1,995.00
95208	30 in weigh frame	24 in	500 lb	1,995.00
95209	36 in weigh frame	30 in	500 lb	1,995.00
95210	42 in weigh frame	36 in	500 lb	1,995.00
95211	48 in weigh frame	42 in	500 lb	1,995.00
95212	54 in weigh frame	48 in	500 lb	1,995.00
96717	60 in weigh frame	54 in	1,000 lb	1,995.00
96718	66 in weigh frame	60 in	1,000 lb	1,995.00
96719	72 in weigh frame	66 in	1,000 lb	1,995.00
Consult	Light capacity weigh frames			Consult
<b>Stainless Steel Weigh Frames</b>				
110837	20 in weigh frame	14 in	500 lb	2,895.00
110838	22 in weigh frame	16 in	500 lb	2,895.00
110839	24 in weigh frame	18 in	500 lb	2,895.00
110840	26 in weigh frame	20 in	500 lb	2,895.00
105246	30 in weigh frame	24 in	500 lb	2,895.00
110841	36 in weigh frame	30 in	500 lb	2,895.00
110842	42 in weigh frame	36 in	500 lb	2,895.00
110843	48 in weigh frame	42 in	500 lb	2,895.00
110844	54 in weigh frame	48 in	500 lb	2,895.00
110845	60 in weigh frame	54 in	500 lb	2,895.00
110846	66 in weigh frame	60 in	500 lb	2,895.00
110847	72 in weigh frame	66 in	500 lb	2,895.00
<b>Weigh Frames Accessories</b>				
97413	Shim, plastic 1/16 in thick			0.25
97414	Shim, plastic 1/8 in thick			0.30
97415	Shim, plastic 1/4 in thick			0.50
97416	Kit, shim 50 each 1/16, 1/8 and 1/4			50.00
69203	Primer, light gray touch-up			20.00
66953	Paint, red touch-up			10.00

Please complete the Belt Scale Questionnaire on page 168 to obtain a quote

## Belt Scale Accessories



High Resolution Speed Sensor



Magnetic Coupler



Speed Wheel



Speed Sensors 125334 &amp; 163319

### Part Number/Price

PART #	DESCRIPTION	ESTIMATED BELT WIDTH	CAPACITY	PRICE
<b>Speed Sensing</b>				
152626	500 PPR high resolution encoder kit, requires 152247 if magnetic coupling is required			\$1,150.00
152247	Magnetic coupler, use with 152626			325.00
125334	Speed sensor, belt scale 50 PPR (generator type)			775.00
163319	Speed sensor, belt scale 600 PPR (encoder type)			895.00
94969	Speed wheel assembly		10 PPR NPN Configuration	695.00
<b>Idler Mounting Bolts (set of 2)</b>				
126282	3 in angle iron base			80.00
126283	4 in angle iron base			90.00
<b>Static Weights</b>				
99708	15 lb weight			145.00
99709	30 lb weight			195.00
99696	3 in static weight mounting bracket (set of 2)			395.00
99922	4 in static weight mounting bracket (set of 2)			450.00
<b>Speed Wheel Replacement Parts</b>				
94979	Sensor proximity			95.00
98320	Shoulder bolt			12.00
95216	Bushing, speed wheel			10.00
<b>Accessories</b>				
21161	J-box, splice single cell			66.00
98501	Cable, load cell custom, 20 ft EL146HE			28.00

*Idler hardware not included with weigh frames*

# BCi

## In-Motion Belt Scale System

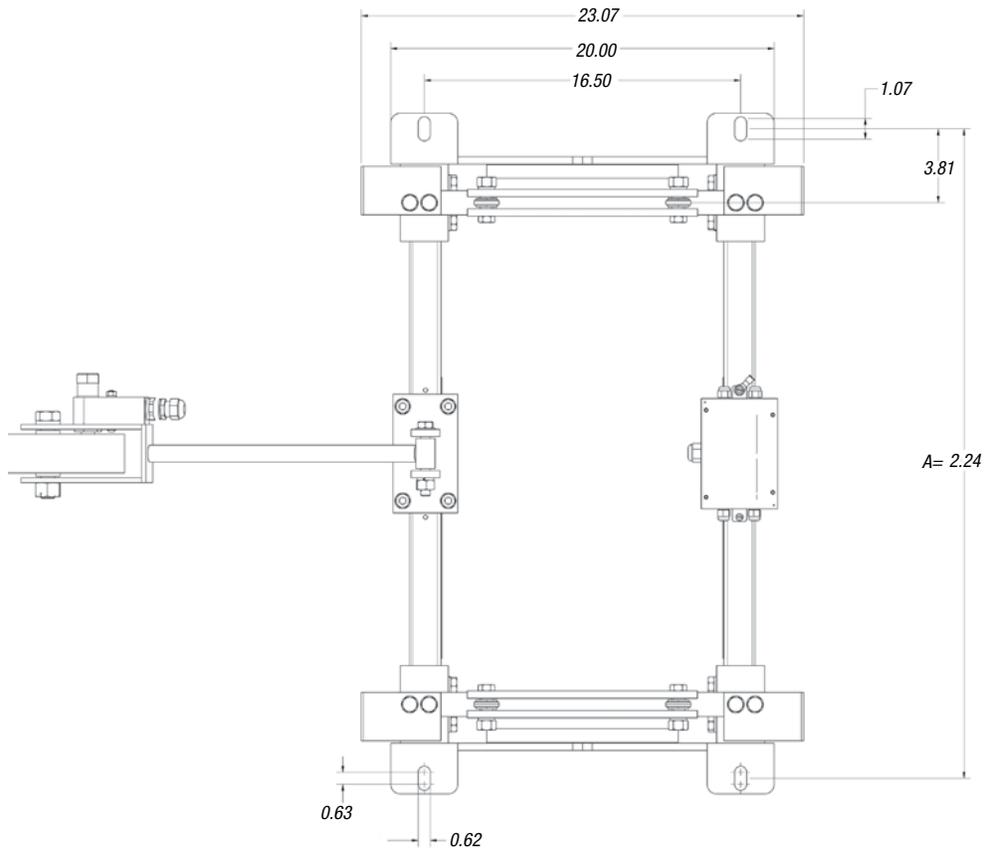
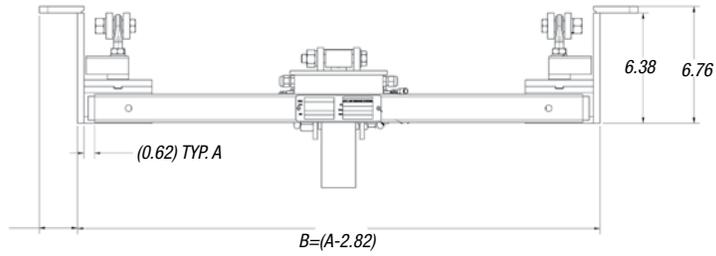

*Note: Cables on drawings removed for clarity. Idler mounting hardware is not included in weigh frame, see idler mounting bolts above*

# Belt Scale Questionnaire



Company \_\_\_\_\_ Prepared By \_\_\_\_\_ Date \_\_\_\_\_  
 Address \_\_\_\_\_  
 City \_\_\_\_\_ State/Zip/Country \_\_\_\_\_  
 Phone \_\_\_\_\_ Fax \_\_\_\_\_ Email \_\_\_\_\_

Application Notes:  
 \_\_\_\_\_  
 \_\_\_\_\_

## MATERIAL

Material being measured \_\_\_\_\_ Bulk Density (lbs/cu. ft) \_\_\_\_\_  
 Corrosive state of material (choose one)  High  Moderate  Not Corrosive  
 Feed Rate t/hr: \_\_\_\_\_ min. \_\_\_\_\_ max. Accuracy Required: +/- \_\_\_\_\_ %  
 Constant Feed Rate:  Yes  No

## CONVEYOR

(Supply sketch where possible)  Sketch attached  
 Application:  Inventory  Load out  Control  Blending  
 Profile:  Horizontal  Incline/decline \_\_\_\_\_ (deg)  Variable Incline \_\_\_\_\_ (deg)  Curved  
 Automatic Tensioning Apparatus:  Yes  No  
 Access Side: (looking in direction of belt travel)  Left  Right  Both  
 Is Area Classified as an Explosive Environment?  Yes  No  
 Does the current conveyor have scale grade idlers?  Yes  No  
 Belt Speed (ft/m per minute): \_\_\_\_\_ min. \_\_\_\_\_ max.  
 Condition of belt? \_\_\_\_\_  
 What type of splice does the belt have? \_\_\_\_\_  
 Belt Length: \_\_\_\_\_ ft/m Belt Width: \_\_\_\_\_ in/cm Belt Cleaning Device:  Yes  No  
 Idler Diameter: \_\_\_\_\_ in/cm Idler Spacing: \_\_\_\_\_ in/cm Tail Pulley Diameter: \_\_\_\_\_ in/cm  
 Trough Angle: \_\_\_\_\_ degrees Conveyor Length: \_\_\_\_\_ ft/m

## INTEGRATOR REQUIREMENTS

Integrator Type:  Deep Universal  Panel Mount  Wall Mount  
 Power Available:  115V  230V  9-36VDC  
 Communications:  AB Remote I/O  Device Net  Profibus-DP  Ethernet IP  
 Analog Output  RS-232 (standard)  Ethernet TCP/IP  Control Net  
 Remote Display Rate:  Yes  No Remote Display Totalizer:  Yes  No  
 Speed Sensor:  Speed Wheel  Shaft Encoder  Magnet

Printer: Model \_\_\_\_\_

# Belt Scale Questionnaire

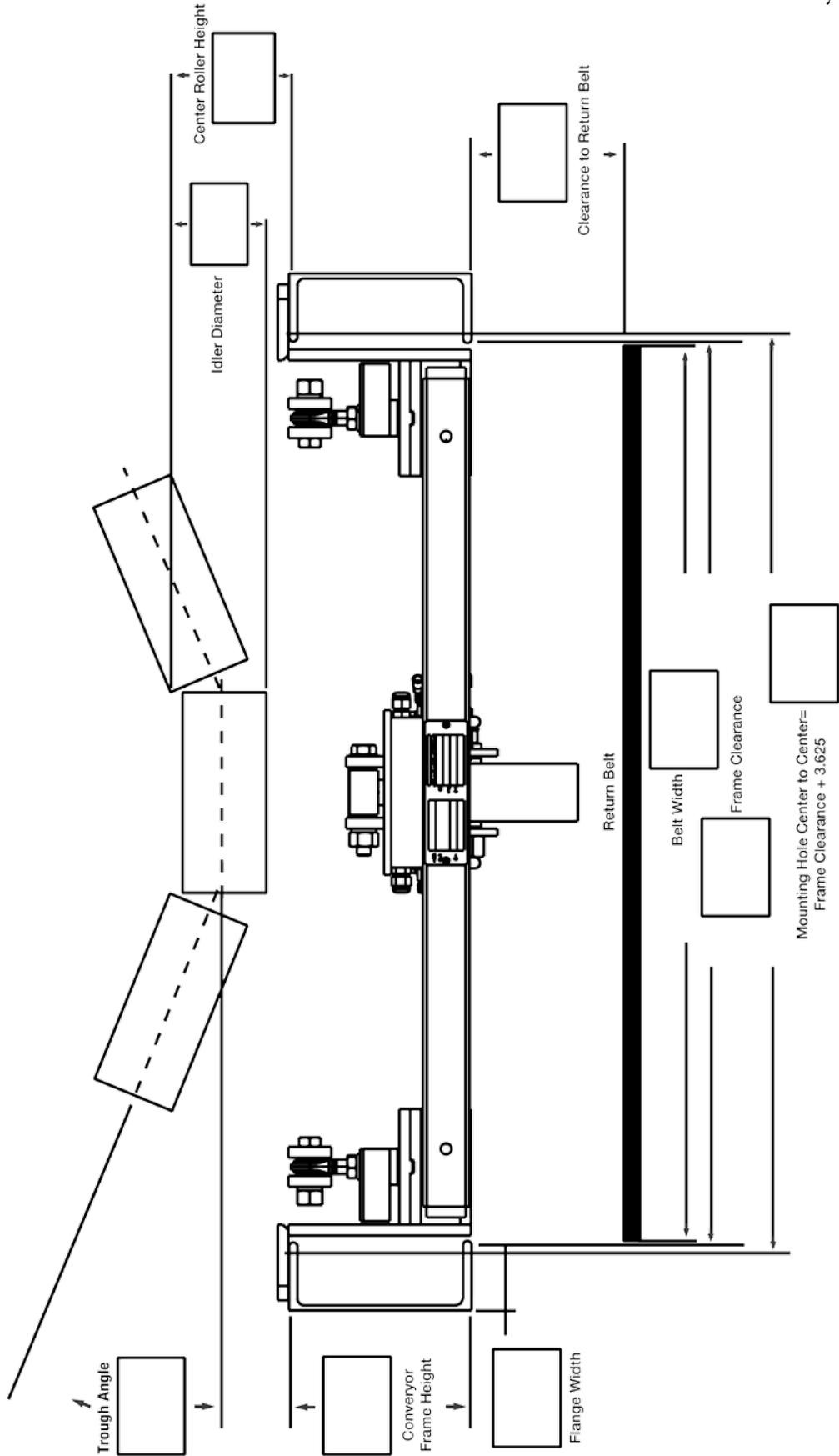





## Bench Scales

### Table of Contents

<b>BenchMark® SL, CW-80B, SL/HE Series</b> .....	<b>172</b>
Light-Capacity Bench Scales	
<b>CW-90B</b> .....	<b>174</b>
Light-Capacity Bench Scales	
<b>CW-90XB</b> .....	<b>175</b>
Light-Capacity Bench Scales	
<b>BenchMark™</b> .....	<b>176</b>
Mild, Stainless Steel, HE Series	
<b>BenchMark™ LP</b> .....	<b>178</b>
Low Profile Bench Scales	
<b>BenchMark™ HD</b> .....	<b>179</b>
Heavy Duty Bench Scales	
<b>BenchMark™ HDP</b> .....	<b>180</b>
Portable Heavy Duty Bench Scales	
<b>DIGI® S-YA/S-YB</b> .....	<b>181</b>
<b>DIGI® S-T-U-V</b> .....	<b>182</b>
<b>DIGI® Bench Scale and Indicator Package</b> .....	<b>183</b>
<b>Ishida iPC Series</b> .....	<b>184</b>
Portable Bench Scales	
<b>Versa-portion®</b> .....	<b>186</b>
Compact Scale	
<b>Ishida IGX and IGB Series</b> .....	<b>187</b>

**ESPAÑOL** | Visit [ricelake.com/spanish](http://ricelake.com/spanish)  
to see all RLWS materials  
available in Spanish

Product names, logos, brands, and other trademarks featured or referred to within this publication are the property of their respective trademark holders.

# BenchMark® SL, CW-80B, SL/HE Series

Light-Capacity Bench Scales

## Standard Features

- 304 stainless steel construction
- LifeGuard™ base design isolates load cell from overloads and shock loads for added durability
- Specially designed adjustable support feet provide exceptional traction and won't scratch surfaces

### SL Series Additional Features

- NTEP Certified aluminum load cell

### CW-80B Series Additional Features

- NTEP Certified stainless steel load cell

### SL/HE Series Additional Features.

- NTEP Certified stainless steel, hermetically sealed load cell

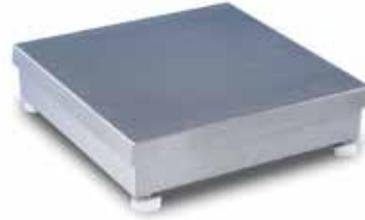

## Specifications

### Load Cell, NTEP Certified:

- SL Series: Aluminum and environmentally sealed
- CW-80B: Stainless steel and environmentally sealed IP67
- HE Series: Stainless steel, hermetically sealed IP69K

### Output Impedance:

- SL and CW-80B: 350 ohms
- HE: 1000 ohms

### Maximum Overload:

- 200%, except 150% for 30 lb HE version

### Overload Protection:

- Shock-absorbing spider

### Cable Length:

- 10 ft (3 m)

### Compensated Temperature Range:

- 14° F to 104° F (-10° C to 40° C)

### Warranty:

- SL and CW-80B: Two-year limited warranty
- HE: Three-year limited warranty including water ingress

### Approvals:

- SL:**  
NTEP CC 95-072, Class III 5,000d, FM,  
Measurement Canada AM-5082, Class III 5,000d
- SL/HE:**  
NTEP CC 95-072, Class III 5,000d,  
Measurement Canada AM-5082, Class III 5,000d
- CW-80B:**  
NTEP CC 96-107, Class III, 3000d, FM,  
Measurement Canada AM-5156, Class III 3,000d

## APPROVALS



Measurement  
Canada  
Approved



Meets USDA  
Requirements

SL/CW-80B

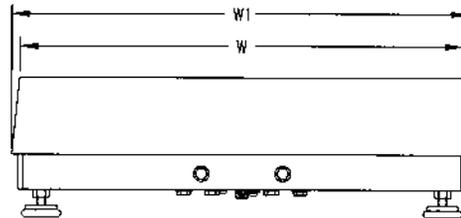
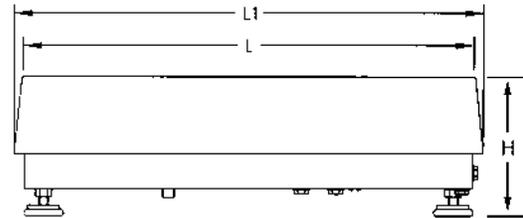

## Dimensions

PART# (SL)	PART# (CW-80B)	PART # (SL/HE)	CAPACITY	PLATFORM SIZE	L1/W1	H (SL & CW-80B)	H (HE)
18575*	N/A	N/A	2 lb (1 kg)	10 x 10 in	10.25 in	3.15 in	3.58 in
18576	N/A	86942	5 lb (2.5 kg)	10 x 10 in	10.25 in	3.15 in	3.58 in
N/A	35075	N/A	6 lb (3 kg)	10 x 10 in	10.25 in	3.15 in	N/A
18577	35076	86943	10 lb (5 kg)	10 x 10 in	10.25 in	3.15 in	3.58 in
N/A	35077	N/A	15 lb (7 kg)	10 x 10 in	10.25 in	3.15 in	3.58 in
18578	N/A	86944	20 lb (10 kg)	10 x 10 in	10.25 in	3.15 in	3.58 in
18579	35078	86945	30 lb (15 kg)	10 x 10 in	10.25 in	3.15 in	3.58 in
32914	35079	86946	30 lb (15 kg)	12 x 12 in	12.25 in	3.25 in	3.63 in
32913	N/A	86947	50 lb (25 kg)	12 x 12 in	12.25 in	3.25 in	3.63 in
N/A	35080	N/A	60 lb (30 kg)	12 x 12 in	12.25 in	3.25 in	3.63 in
35198	N/A	86948	100 lb (50 kg)	12 x 12 in	12.25 in	3.25 in	3.63 in

\*Non-NTEP

Note: 1"=25.4 mm

# BenchMark® SL , CW-80B, SL/HE Series

Light Capacity Bench Scales

## Part Number/Price

PART #	PLATFORM CAPACITY	DIMENSIONS	EST. SHIP WEIGHT	PRICE
<b>SL Series</b>				
18575*	2lb	10 x 10 x 3.15 in	13 lb	\$640.00
18576	5lb	10 x 10 x 3.15 in	13 lb	640.00
18577	10lb	10 x 10 x 3.15 in	13 lb	640.00
18578	20lb	10 x 10 x 3.15 in	13 lb	640.00
18579	30lb	10 x 10 x 3.15 in	13 lb	640.00
32914	30lb	12 x 12 x 3.25 in	14 lb	720.00
32913	50lb	12 x 12 x 3.25 in	14 lb	720.00
35198	100lb	12 x 12 x 3.25 in	14 lb	720.00
<b>CW-80B Series</b>				
35075	6lb	10 x 10 x 3.15 in	13 lb	730.00
35076	10lb	10 x 10 x 3.15 in	13 lb	730.00
35077	15lb	10 x 10 x 3.15 in	13 lb	730.00
35078	30lb	10 x 10 x 3.15 in	13 lb	730.00
35079	30lb	12 x 12 x 3.25 in	14 lb	840.00
35080	60lb	12 x 12 x 3.25 in	14 lb	840.00
<b>SL/HE Series</b>				
86942	5lb	10 x 10 x 3.58 in	13 lb	1,005.00
86943	10lb	10 x 10 x 3.58 in	13 lb	1,005.00
86944	20lb	10 x 10 x 3.58 in	13 lb	1,005.00
86945	30lb	10 x 10 x 3.58 in	13 lb	1,005.00
86946	30lb	12 x 12 x 3.63 in	13 lb	1,085.00
86947	50lb	12 x 12 x 3.63 in	14 lb	1,085.00
86948	100lb	12 x 12 x 3.63 in	14 lb	1,085.00

## Options/Accessories

PART #	DESCRIPTION	PRICE
53001	304 stainless steel clamshell for added load cell protection (for SL and CW-80B series)	\$125.00
112044	12 in column for IQ plus® 210, 320IS (without battery option), 320IS plus (without battery option), IQ plus® 390-DC, IQ plus® 590-DC, 420 plus®, CW-90, CW-90X and 480 Legend	135.00
112045	18 in column for IQ plus® 210, 320IS (without battery option), 320IS plus (without battery option), IQ plus® 390-DC, IQ plus® 590-DC, 420 plus®, CW-90, CW-90X and 480 Legend	180.00
64576	Attachment bracket for IQ plus® 210 or 420 plus, 320IS (without battery option), 320IS plus (without battery option) and 480 Legend	51.50
64577	Attachment bracket for IQ plus® 390-DC or IQ plus® 590-DC	51.50
22125	Additional operating manual	5.25

\* Non-NTEP

# CW-90B

## Light-Capacity Bench Scales

### Standard Features

- 304 stainless steel construction
- Five point overload protection
- Specially designed adjustable support feet provide exceptional traction and will not scratch surfaces
- Aluminum environmentally sealed load cell

### Specifications

**Load Cell, NTEP Certified:**

Aluminum and environmentally sealed

**Output Impedance:**

350 ohms

**Maximum Overload:**

180% to 200% depending on capacity

**Overload Protection:**

Five point, independently adjusted

**Cable Length:**

34 in or 10 ft

**Compensated Temperature Range:**

14° F to 104° F (-10° C to 40° C)

**Warranty:**

Two-year limited warranty

**Approvals:**

NTEP CC 95-072, Class III 5,000d

Measurement Canada AM-5082, Class III 5,000d



### APPROVALS



Measurement  
Canada  
Approved



### Part Number/Price

PART #		PLATFORM CAPACITY	DIMENSIONS	EST. SHIP WEIGHT	PRICE
10 ft cable	34 in cable				
112599	106137	5 lb	10 x 10 x 4.25 in	14 lb	\$640.00
112601	106138	10 lb	10 x 10 x 4.25 in	14 lb	640.00
112603	106139	25 lb	10 x 10 x 4.25 in	14 lb	640.00
112605	106140	25 lb	12 x 12 x 4.25 in	17 lb	720.00
112607	106141	50 lb	12 x 12 x 4.25 in	17 lb	720.00
112609	106142	100 lb	12 x 12 x 4.25 in	17 lb	720.00

### Options/Accessories

PART #	DESCRIPTION	PRICE
112044	12 in column for IQ plus® 210, 320IS (without battery option), 320IS plus (without battery option), IQ plus® 390-DC, IQ plus® 590-DC, 420 plus®, CW-90, CW-90X and 480 Legend	\$135.00
112045**	18 in column for IQ plus® 210, 320IS (without battery option), 320IS plus (without battery option), IQ plus® 390-DC, IQ plus® 590-DC, 420 plus®, CW-90, CW-90X and 480 Legend	180.00

\*\* Not recommended for use with scale bases smaller than 12 in x 12 in

#### DRAWING DIMENSIONS

**10 in x 10 in**

A	4.25 in (107.95 mm)	C	10.37 in (263.40 mm)
B	10.37 in (263.40 mm)		

**12 in x 12 in**

A	4.25 in (107.95 mm)	C	12.37 in (314.20 mm)
B	12.37 in (314.20 mm)		

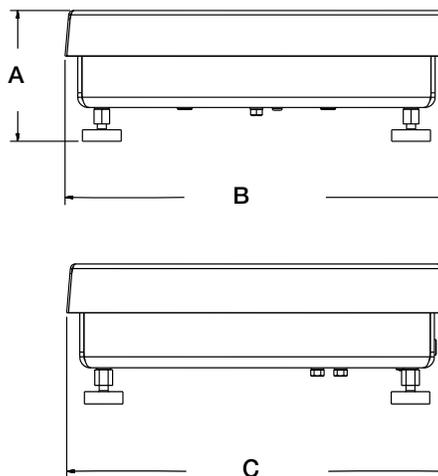

# CW-90XB

## Light-Capacity Bench Scales

### Standard Features

- 304 stainless steel construction
- Five point overload protection
- Specially designed adjustable support feet provide exceptional traction and will not scratch surfaces
- IP69K, stainless steel hermetically sealed load cell

### Specifications

**Load Cell, NTEP Certified:**

Stainless steel and hermetically sealed, IP69K

**Output Impedance:**

350 ohms

**Maximum Overload:**

180% to 200% depending on capacity

**Overload Protection:**

Five point, independently adjusted

**Cable Length:**

34 in or 10 ft

**Compensated Temperature Range:**

14° F to 104° F (-10° C to 40° C)

**Warranty:**

Three years including water ingress

**Approvals:**

NTEP CC 95-072, Class III 5,000d

Measurement Canada AM-5082, Class III 5,000d



### APPROVALS



Measurement  
Canada  
Approved



### Part Number/Price

PART #		PLATFORM CAPACITY	DIMENSIONS	EST. SHIP WEIGHT	PRICE
10 ft cable	34 in cable				
112600	106143	5 lb	10 x 10 x 4.25 in	14 lb	\$1,005.00
112602	106144	10 lb	10 x 10 x 4.25 in	14 lb	1,005.00
112604	106145	25 lb	10 x 10 x 4.25 in	14 lb	1,005.00
112606	106146	25 lb	12 x 12 x 4.25 in	17 lb	1,085.00
112608	106147	50 lb	12 x 12 x 4.25 in	17 lb	1,085.00
112610	106148	100 lb	12 x 12 x 4.25 in	17 lb	1,085.00

### Options/Accessories

PART #	DESCRIPTION	PRICE
112044	12 in column for IQ plus® 210, 320IS (without battery option), 320IS plus (without battery option), IQ plus® 390-DC, IQ plus® 590-DC, 420 plus®, CW-90, CW-90X and 480 Legend	\$135.00
112045**	18 in column for IQ plus® 210, 320IS (without battery option), 320IS plus (without battery option), IQ plus® 390-DC, IQ plus® 590-DC, 420 plus®, CW-90, CW-90X and 480 Legend	180.00

\*\* Not recommended for use with scale bases smaller than 12 in x 12 in

DRAWING DIMENSIONS			
<b>10 in x 10 in</b>			
A	4.25 in (107.95 mm)	C	10.37 in (263.40 mm)
B	10.37 in (263.40 mm)		
<b>12 in x 12 in</b>			
A	4.25 in (107.95 mm)	C	12.37 in (314.20 mm)
B	12.37 in (314.20 mm)		

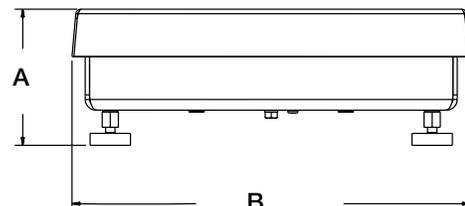
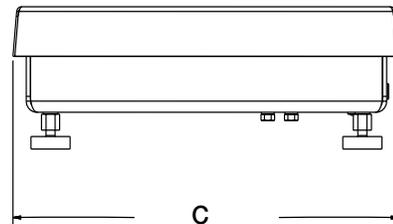

# BenchMark™

Mild, Stainless Steel, HE Series

## Standard Features

- 304 stainless steel construction
- LifeGuard™ base design isolates load cell from overloads and shock loads for added durability
- Specially designed adjustable support feet provide exceptional traction and will not scratch surfaces



## Specifications

### Load Cell, NTEP Certified:

Mild steel and stainless steel: aluminum, environmentally sealed  
HE: Stainless steel, hermetically sealed, IP69

### Output Impedance:

Mild steel and stainless steel: 350 ohms  
HE: 1000 ohms

### Maximum Overload:

150-200% depending on capacity

### Overload Protection:

Five point, independently adjusted

### Cable Length:

10 ft (3 m)

### Compensated Temperature Range:

14° F to 104° F (-10° C to 40° C)

### Warranty:

Mild steel and stainless steel: Two-year limited warranty  
HE: Three-year limited warranty including water ingress

### Approvals:

NTEP CC 95-072, Class III, 5,000d,  
Measurement Canada AM-5082, Class III, 5,000d

## APPROVALS



Measurement  
Canada  
Approved



Meets USDA  
Requirements

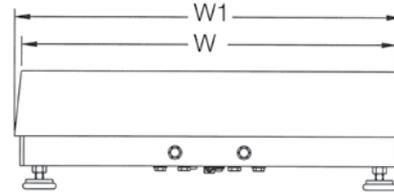
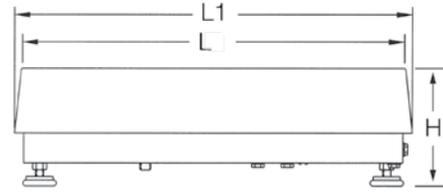

## Dimensions

PART # (MILD)	PART # (STAINLESS)	PART # (HE)	CAPACITY	PLATFORM SIZE	L1	W1	H (MILD & STAINLESS STEEL)	H (HE)
18580	N/A	N/A	30 (15 kg)	12 x 12 in	12.50 in	12.50 in	4.12 in	N/A
18582	N/A	N/A	50 (25 kg)	12 x 12 in	12.50 in	12.50 in	4.12 in	N/A
18584	N/A	N/A	100 (50 kg)	12 x 12 in	12.50 in	12.50 in	4.12 in	N/A
18586	32918	86950	50 (25 kg)	12 x 18 in	12.50 in	18.50 in	MS 4.12 in SST 3.62 in	4 in
18588	32919	86951	100 (50 kg)	12 x 18 in	12.50 in	18.50 in	MS 4.12 in SST 3.62 in	4 in
18590	18591	86952	50 (25 kg)	18 x 18 in	18.75 in	18.75 in	5.25 in	5.25 in
18592	18593	86953	100 (50 kg)	18 x 18 in	18.75 in	18.75 in	5.25 in	5.25 in
18594	18595	86954	150 (75 kg)	18 x 18 in	18.75 in	18.75 in	5.25 in	5.25 in
18596	18597	86955	200 (100 kg)	18 x 18 in	18.75 in	18.75 in	5.25 in	5.25 in
18598	18599	86956	250 (125 kg)	18 x 18 in	18.75 in	18.75 in	5.25 in	5.5 in
18600	18601	86957	300 (150 kg)	18 x 18 in	18.75 in	18.75 in	5.25 in	5.5 in
18602	18603	86958	500 (250 kg)	18 x 18 in	18.75 in	18.75 in	5.25 in	5.5 in
18604	18605	86959	1,000 (500 kg)	18 x 18 in	18.75 in	18.75 in	5.25 in	5.5 in
18606	18607	86960	50 (25 kg)	18 x 24 in	24.75 in	18.75 in	5.25 in	5.25 in
18608	18609	86961	100 (50 kg)	18 x 24 in	24.75 in	18.75 in	5.25 in	5.25 in
18610	18611	86962	150 (75 kg)	18 x 24 in	24.75 in	18.75 in	5.25 in	5.25 in
18612	18613	86963	200 (100 kg)	18 x 24 in	24.75 in	18.75 in	5.25 in	5.25 in
18614	18615	86964	250 (125 kg)	18 x 24 in	24.75 in	18.75 in	5.25 in	5.5 in
18616	18617	86965	300 (150 kg)	18 x 24 in	24.75 in	18.75 in	5.25 in	5.5 in
18618	18619	86966	500 (250 kg)	18 x 24 in	24.75 in	18.75 in	5.25 in	5.5 in
18620	18621	86967	1,000 (500 kg)	18 x 24 in	24.75 in	18.75 in	5.25 in	5.5 in
18622	18623	86968	100 (50 kg)	24 x 24 in	24.75 in	24.75 in	5.25 in	5.25 in
18624	18625	86969	150 (75 kg)	24 x 24 in	24.75 in	24.75 in	5.25 in	5.25 in
18626	18627	86970	200 (100 kg)	24 x 24 in	24.75 in	24.75 in	5.25 in	5.25 in
18628	18629	86971	250 (125 kg)	24 x 24 in	24.75 in	24.75 in	5.25 in	5.5 in
18630	18631	86972	300 (150 kg)	24 x 24 in	24.75 in	24.75 in	5.25 in	5.5 in
18632	18633	86973	500 (250 kg)	24 x 24 in	24.75 in	24.75 in	5.25 in	5.5 in
18634	18635	86974	1,000 (500 kg)	24 x 24 in	24.75 in	24.75 in	5.25 in	5.5 in

Note: 1"=25.4 mm

## Part Number/Price

PART #	CAPACITY	PLATFORM DIMENSIONS	EST. SHIP WEIGHT	PRICE
<b>Mild Steel Series</b>				
18580	30 lb	12 x 12 x 4.12 in	20 lb	\$730.00
18582	50 lb	12 x 12 x 4.12 in	20 lb	730.00
18584	100 lb	12 x 12 x 4.12 in	20 lb	730.00
18586	50 lb	12 x 18 x 4.12 in	37 lb	810.00
18588	100 lb	12 x 18 x 4.12 in	37 lb	810.00
18590	50 lb	18 x 18 x 5.25 in	68 lb	990.00
18592	100 lb	18 x 18 x 5.25 in	68 lb	990.00
18594	150 lb	18 x 18 x 5.25 in	68 lb	990.00
18596	200 lb	18 in x 18 x 5.25 in	68 lb	990.00
18598	250 lb	18 x 18 x 5.25 in	68 lb	990.00
18600	300 lb	18 x 18 x 5.25 in	68 lb	990.00
18602	500 lb	18 x 18 x 5.25 in	68 lb	990.00
18604	1,000 lb	18 x 18 x 5.25 in	68 lb	1,100.00
18606	50 lb	18 x 24 x 5.25 in	78 lb	1,100.00
18608	100 lb	18x 24 x 5.25 in	78 lb	1,100.00
18610	150 lb	18 x 24 x 5.25 in	78 lb	1,100.00
18612	200 lb	18 x 24 x 5.25 in	78 lb	1,100.00
18614	250 lb	18 x 24 x 5.25 in	78 lb	1,100.00
18616	300 lb	18 x 24 x 5.25 in	78 lb	1,100.00
18618	500 lb	18 x 24 x 5.25 in	78 lb	1,100.00
18620	1,000 lb	18 x 24 x 5.25 in	78 lb	1,215.00
18622	100 lb	24 x 24 x 5.25 in	78 lb	1,215.00
18624	150 lb	24 x 24 x 5.25 in	84 lb	1,215.00
18626	200 lb	24 x 24 x 5.25 in	84 lb	1,215.00
18628	250 lb	24 x 24 x 5.25 in	84 lb	1,215.00
18630	300 lb	24 x 24 x 5.25 in	84 lb	1,215.00
18632	500 lb	24 x 24 x 5.25 in	84 lb	1,330.00
18634	1,000 lb	24 x 24 x 5.25 in	84 lb	1,330.00
<b>Stainless Steel Series</b>				
32918	50 lb	12 x 18 x 3.62 in	37 lb	900.00
32919	100 lb	12 x 18 x 3.62 in	37 lb	900.00
18591	50 lb	18 x 18 x 5.25 in	68 lb	1,245.00
18593	100 lb	18 x 18 x 5.25 in	68 lb	1,245.00
18595	150 lb	18 x 18 x 5.25 in	68 lb	1,245.00
18597	200 lb	18 x 18 x 5.25 in	68 lb	1,245.00
18599	250 lb	18 x 18 x 5.25 in	68 lb	1,245.00
18601	300 lb	18 x 18 x 5.25 in	68 lb	1,245.00
18603	500 lb	18 x 18 x 5.25 in	68 lb	1,395.00
18605	1,000 lb	18 x 18 x 5.25 in	68 lb	1,395.00
18607	50 lb	18 x 24 x 5.25 in	78 lb	1,480.00
18609	100 lb	18 x 24 x 5.25 in	78 lb	1,480.00
18611	150 lb	18 x 24 x 5.25 in	78 lb	1,480.00
18613	200 lb	18 x 24 x 5.25 in	78 lb	1,480.00
18615	250 lb	18 x 24 x 5.25 in	78 lb	1,480.00
18617	300 lb	18 x 24 x 5.25 in	78 lb	1,480.00
18619	500 lb	18 x 24 x 5.25 in	78 lb	1,480.00
18621	1,000 lb	18 x 24 x 5.25 in	78 lb	1,765.00
18623	100 lb	24 x 24 x 5.25 in	84 lb	1,765.00
18625	150 lb	24 x 24 x 5.25 in	84 lb	1,825.00
18627	200 lb	24 x 24 x 5.25 in	84 lb	1,825.00
18629	250 lb	24 x 24 x 5.25 in	84 lb	1,825.00

## Part Number/Price

PART #	CAPACITY	PLATFORM DIMENSIONS	EST. SHIP WEIGHT	PRICE
18631	300 lb	24 x 24 x 5.25 in	84 lb	\$1,825.00
18633	500 lb	24 x 24 x 5.25 in	84 lb	1,905.00
18635	1,000 lb	24 x 24 x 5.25 in	84 lb	1,905.00
<b>HE Series</b>				
86950	50 lb	12 x 18 x 4 in	37 lb	1,270.00
86951	100 lb	12 x 18 x 4 in	37 lb	1,270.00
86952	50 lb	18 x 18 x 5.25 in	68 lb	1,615.00
86953	100 lb	18 x 18 x 5.25 in	68 lb	1,615.00
86954	150 lb	18 x 18 x 5.25 in	68 lb	1,615.00
86955	200 lb	18 x 18 x 5.25 in	68 lb	1,615.00
86956	250 lb	18 x 18 x 5.5 in	68 lb	1,770.00
86957	300 lb	18 x 18 x 5.5 in	68 lb	1,770.00
86958	500 lb	18 x 18 x 5.5 in	68 lb	1,920.00
86959	1,000 lb	18 x 18 x 5.5 in	68 lb	1,920.00
86960	50 lb	18 x 24 x 5.25 in	78 lb	1,850.00
86961	100 lb	18 x 24 x 5.25 in	78 lb	1,850.00
86962	150 lb	18 x 24 x 5.25 in	78 lb	1,850.00
86963	200 lb	18 x 24 x 5.25 in	78 lb	1,850.00
86964	250 lb	18 x 24 x 5.5 in	78 lb	2,010.00
86965	300 lb	18 x 24 x 5.5 in	78 lb	2,010.00
86966	500 lb	18 x 24 x 5.5 in	78 lb	2,290.00
86967	1,000 lb	18 x 24 x 5.5 in	78 lb	2,290.00
86968	100 lb	24 x 24 x 5.25 in	84 lb	2,190.00
86969	150 lb	24 x 24 x 5.25 in	84 lb	2,190.00
86970	200 lb	24 x 24 x 5.25 in	84 lb	2,190.00
86971	250 lb	24 x 24 x 5.5 in	84 lb	2,350.00
86972	300 lb	24 x 24 x 5.5 in	84 lb	2,350.00
86973	500 lb	24 x 24 x 5.5 in	84 lb	2,430.00
86974	1,000 lb	24 x 24 x 5.5 in	84 lb	2,430.00

## Options/Accessories

PART #	DESCRIPTION	PRICE
53001**	304 stainless steel clamshell for added load cell protection (12 x 12 in, 12 x 18 in) (for mild and stainless steel)	\$125.00
41292**	304 stainless steel clamshell for added load cell protection (18 x 18 in, 18 x 24 in and 24 x 24 in), does not include 1,000 lb capacity (for mild and stainless steel)	125.00
18805**	304 stainless steel clamshell for added load cell protection (18 x 18 in 18 x 24 in and 24 x 24 in), 1,000 lb capacity only	125.00
112044	12 in column for IQ plus® 210, 320IS (without battery option), 320IS Plus (without battery option), 390-DC or IQ plus® 590-DC, 420 plus®, CW-90, CW-90X and 480 Legend	135.00
112045*	18 in column for IQ plus® 210, 320IS (without battery option), 320IS Plus (without battery option) 390-DC or IQ plus® 590-DC, 420 plus®, CW-90, CW-90X and 480 Legend	180.00
64576	Attachment bracket for IQ plus® 210, 420 plus, 320IS (without battery option), 320IS Plus (without battery option) and 480 Legend	51.50
64577	Attachment bracket for IQ plus® 390-DC or IQ plus® 590-DC	51.50
22125	Additional operating manual	5.25

\* Not recommended for use with scale bases smaller than 12 x 12 in

\*\* Not for use with HE Series

# BenchMark™ LP

## Low Profile Bench Scales

### Standard Features

- Mild steel base construction
- 304 stainless steel cover
- ABS junction box
- Four planar beam load cells
- Adjustable leveling feet
- 20 ft of EL147 load cell cable
- Holes in lower frame for mounting scale without adjustable leveling feet

### Specifications

**Load Cell, Rated Output:**

1.0 mV/V +/- 10%

**End Load Capacity:**

60% of full scale capacity

**Cable Length:**

20 ft (6.1 m) for connecting j-box to indicator

**Warranty:**

Two-year limited warranty

**Approvals:**

NTEP CC 08-017, Class III 5,000d (except 1000 lb capacity)

Measurement Canada AM 5660, Class III 5,000d (except 500 kg capacity)



*Ideal for Aviation Weighing. A complete system can be sold with the Tracer® AV. Reference Aviation section for specifications*



### APPROVALS



Measurement  
Canada  
Approved

### Part Number/Price

PART #	CAPACITY	PLATFORM DIMENSIONS	EST. SHIP WEIGHT	PRICE
97662	100 lb (50 kg)	18 x 18 x 2.54 in (2.00 in*)	75 lb	\$1,065.00
97663	250 lb (125 kg)	18 x 18 x 3.06 in (2.18 in*)	85 lb	1,090.00
97664	500 lb (250 kg)	18 x 18 x 3.06 in (2.26 in*)	85 lb	1,115.00
97665	100 lb (50 kg)	24 x 24 x 2.54 in (2.00 in*)	85 lb	1,275.00
97666	250 lb (125 kg)	24 x 24 x 3.00 in (2.18 in*)	100 lb	1,300.00
97667	500 lb (250 kg)	24 x 24 x 3.06 in (2.26 in*)	100 lb	1,325.00
97668	500 lb (250 kg)	30 x 30 x 3.06 in (2.26 in*)	150 lb	1,525.00
97669**	1,000 lb (500 kg)	30 x 30 x 3.38 in (2.58 in*)	190 lb	1,575.00
97670	500 lb (250 kg)	36 x 36 x 3.06 in (2.26 in*)	175 lb	2,000.00
97671**	1,000 lb (500 kg)	36 x 36 x 3.38 in (2.58 in*)	175 lb	2,050.00

\*Height without adjustable leveling feet

\*\* Non-NTEP and not Measurement Canada Approved



# BenchMark™ HD

Heavy Duty Bench Scales

## Specifications

**Load Cell, NTEP Certified:**

Aluminum, environmentally sealed

**Output Impedance:**

350 ohms

**Maximum Overload:**

200%

**Overload Protection:**

Five-point, independently adjusted

**Cable Length:**

10 ft (3 m)

**Compensated Temperature Range:**

14° F to 104° F (-10° C to 40° C)

**Warranty:**

Two-year limited warranty

**Approvals:**

NTEP CC 06-010, Class III 5,000d

Measurement Canada AM-5625, Class III 5,000d



## APPROVALS



Measurement  
Canada  
Approved



## Part Number/Price

PART #	CAPACITY	PLATFORM DIMENSIONS	EST. SHIP WEIGHT	PRICE
93414	250 lb (125 kg)	30 x 30 x 8.75 in	300 lb	\$1,675.00
93415	500 lb (225 kg)	30 x 30 x 8.75 in	300 lb	1,675.00
93416	250 lb (125 kg)	36 x 36 x 8.75 in	330 lb	2,035.00
93417	500 lb (225 kg)	36 x 36 x 8.75 in	330 lb	2,035.00

Consult factory for modifications for airport baggage scales.

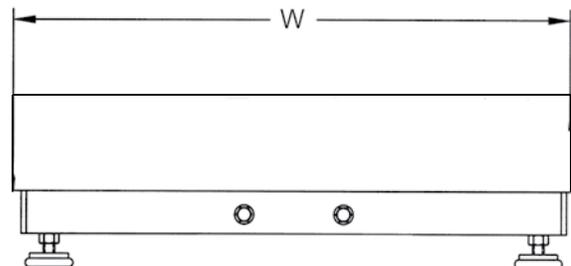
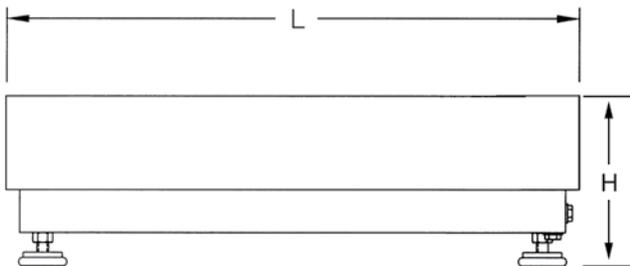

# BenchMark™ HDP

Portable Heavy Duty Bench Scales

## Standard Features

- Mild steel base construction
- 304 stainless steel cover
- Indicator stand for mounting IQ plus 390-DC, IQ plus 590-DC and 480 Legend
- Wheel Model
- Polyurethane rubber leveling feet with stainless steel stems
- 8 in diameter preformed rubber wheels with ball bearings
- Caster Model
- 3 1/2 in diameter preformed rubber casters, two fixed, two swivel with lock

## Specifications

### Load Cell, NTEP Certified:

Aluminum, environmentally sealed

### Output Impedance:

350 ohms

### Maximum Overload:

200%

### Overload Protection:

Five-point, independently adjusted

### Cable Length:

10 ft (3 m)

### Compensated Temperature Range:

14°F to 104°F (-10°C to 40°C)

### Warranty:

Two-year limited warranty

### Approvals:

NTEP CC 06-010, Class III 5,000d

Measurement Canada AM-5625, Class III 5,000d



*Ideal for Aviation Weighing. A complete system can be sold with the Tracer® AV. Reference Aviation section for specifications*



## APPROVALS



Measurement  
Canada  
Approved



## Part Number/Price

PART #	CAPACITY	PLATFORM DIMENSIONS	EST. SHIP WEIGHT	PRICE
<b>Wheel Model</b>				
97072	250 lb (125 kg)	24 x 24 x 8.75 in	275 lb	\$1,675.00
97073	500 lb (225 kg)	24 x 24 x 8.75 in	275 lb	1,675.00
<b>Caster Model</b>				
97074	250 lb (125 kg)	24 x 24 x 9.31 in	290 lb	1,675.00
97075	500 lb (225 kg)	24 x 24 x 9.31 in	290 lb	1,675.00

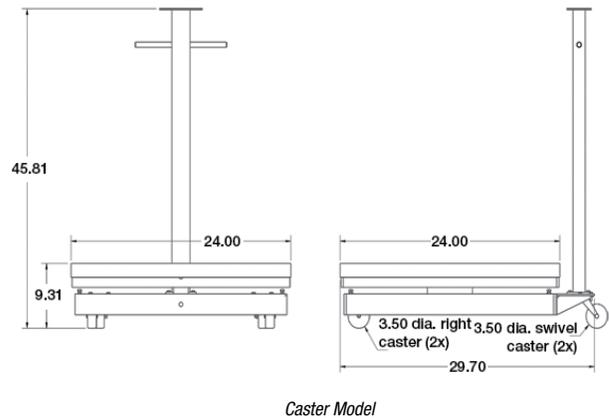
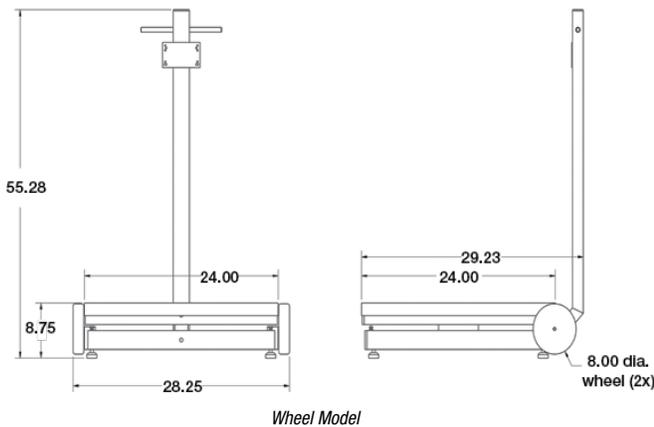

# DIGI® S-YA/S-YB

## Standard Features

- Rust-proof coated carbon steel base
- Stainless steel platter
- Maintains 0.03% accuracy through full range
- Large 3 in (76.2 mm) adjustable leveling feet
- Aluminum load cell

## Specifications

### Load Cell Material:

Aluminum, butyl rubber coated

### Load Cell Type:

Single point strain gauge

### Recommended Exc. Voltage:

5–12VDC

### Max EXC. Voltage:

S-YA: 12VDC, AC

S-YB: 20VDC, AC

### Output Impedance:

1000 ±10 Ω (S-YA)

350 ±10 Ω (S-YB)

### Insulation Resistance:

500 MΩ

### Load Cell Cable Length:

8 ft (2.4 m) with 14-Pin connector

### Temperature Range:

14° F to 104° F (10° C to 40° C)

### Warranty:

Two-year limited warranty

### Load Cell Color Code:

Red .....+ Excitation

White .....- Excitation

Green .....+ Signal

Yellow .....- Signal

Blue .....+ Sense

Orange .....- Sense

Bare ..... Shield



## Part Number/Price

PART#	MODEL	CAPACITY	PLATFORM DIMENSION	EST. SHIP WEIGHT	PRICE
74151	S-YA	60 lb (30 kg)	15 x 15 in	25 lb (12 kg)	\$615.00
74152	S-YA	150 lb (60 kg)	15 x 15 in	25 lb (12 kg)	615.00
74153	S-YA	300 lb (150 kg)	15 x 15 in	25 lb (12 kg)	615.00
74154	S-YB	150 lb (60 kg)	19 x 19 in	48 lb (22 kg)	615.00
74155	S-YB	300 lb (150 kg)	19 x 19 in	48 lb (22 kg)	615.00
74156	S-YB	500 lb (300 kg)	19 x 19 in	48 lb (22 kg)	615.00

# DIGI® S-T-U-V

## Standard Features

- IP66-rated
- Platform support in each corner
- Shock resistant load cells
- Rated to 300% overload

## Specifications

**Recommended Exc. Voltage:**

5-12VDC

**Max Exc. Voltage:**

20VAC/DC

**Output Impedance:**

350 ±10Ω

**Insulation Resistance:**

500MΩ or more

**Rated Output:**

0.83 mV/V ±7.5%

**Rated Input:**

1 mV/V ±7.5%

**Load Cell Cable Length:**

S-S/S-T: 9 ft (3 m) with 14 pin connector

S-U: 18 ft (5.5 m) with 14 pin connector

S-V: 28 ft (8.5 m) with 14 pin connector

**Temperature Range:**

14°F to 104°F (-10°C to 40°C)

**Warranty:**

Two-year limited warranty

**Approvals:**

NTEP CC 02-111, Class III, 5000d

Measurement Canada AM-5393, Class III 5,000d



## APPROVALS



Measurement  
Canada  
Approved

## Part Number/Price

PART#	MODEL	CAPACITY	DIMENSIONS	EST. SHIP WEIGHT	PRICE
<b>Carbon Steel Platform – Stainless Steel Platter</b>					
73248†	S-SL	60 lb (30 kg)	13 x 17 x 3.5 in	30 lb (14 kg)	\$715.00
73246	S-SL	150 lb (60 kg)	13 x 17 x 3.5 in	30 lb (14 kg)	715.00
73247	S-SL	300 lb (150 kg)	13 x 17 x 3.5 in	30 lb (14 kg)	715.00
73250	S-TL	150 lb (60 kg)	17 x 21 x 4.5 in	50 lb (23 kg)	920.00
73251	S-TL	300 lb (150 kg)	17 x 21 x 4.5 in	50 lb (23 kg)	920.00
73252†	S-TL	500 lb (300 kg)	17 x 21 x 4.5 in	50 lb (23 kg)	920.00
74508	S-UL	150 lb (60 kg)	24 x 28 x 5 in	90 lb (41 kg)	1,130.00
73256	S-UL	300 lb (150 kg)	24 x 28 x 5 in	90 lb (41 kg)	1,130.00
73257	S-UL	500 lb (300 kg)	24 x 28 x 5 in	90 lb (41 kg)	1,130.00
76511*	S-VL	1,500 lb (600 kg)	24 x 28 x 6 in	130 lb (59 kg)	1,130.00

\* Non NTEP

† Measurement Canada Approved

# DIGI<sup>®</sup> Bench Scale and Indicator Package

## Standard Features

- Large 0.8 in (20.3mm) six-digit red LED or LCD display
- 115-230 VAC
- EPD and printer port for connecting to a PC or printer
- Programmable print output strings
- Available in 150 lb/60 kg, 300 lb/150 kg, 500 lb/300 kg capacities
- Selectable unit of measure lb/kg/g/oz
- Carbon steel platform, stainless steel platter (STL)

## Specifications

### Power:

Line voltages: 115-230  
Frequency: 50 or 60 Hz

### Serial Output:

EDP port: Full duplex RS-232  
Printer port: Output-only RS-232 or active 20 mA current loop  
Both ports: 9600, 4800, 2400, 1200, 600, 300 bps; 7 or 8 data bits; even, odd or no parity

### Display:

0.8 in (20 mm), 6-digit Super Red Light Emitting Diode (LED) display, 7-segment, digits

### Status Annunciators:

Designators for: center of zero, stand still, gross, net center of zero, standstill, lb, kg, oz, g  
\*Battery, setpoint 1 and 2, HI-OK-LO, Hold

### Keyboard:

5-key flat membrane panel, tactile feel

### Operating Temperature:

Legal: 14° F to 104° F (-10° C to 40° C)  
Industrial: 14° F to 122° F (-10° C to 50° C)

### Rating/Material:

Enclosure: heavy gauge ABS

### Warranty:

One-year limited warranty

### Scale Approvals:

NTEP CC 02-111, Class III 5,000d  
Measurement Canada AM-5393, Class III 5,000d (500 lb/300 kg only)

### Indicator Approval:

NTEP CC 03-059, Class III/IIIL 10,000d  
Measurement Canada AM-5517, Class III/IIHD 10,000d



## APPROVALS



Measurement  
Canada  
Approved



## Part Number/Price

PART#	CAPACITY	PLATFORM DIMENSION	EST. SHIP WEIGHT	PRICE
83303	150 lb/60 kg x 0.05 lb/0.02 kg	17 x 21 x 4.5 in	57 lb	\$940.00
83304	300 lb/150 kg x 0.1 lb/0.05 kg	17 x 21 x 4.5 in	57 lb	940.00
83305†	500 lb/300 kg x 0.1 lb/0.1 kg	17 x 21 x 4.5 in	57 lb	940.00

† Measurement Canada Approved

## Options/Accessories

PART#	DESCRIPTION	PRICE
73381	4 in (100 mm) castors (four swivels, two with brakes)	\$250.00

## DRAWING DIMENSIONS

A	21 in	D	3.94 in
B	24.6 in	E	23.9 in
C	17 in	F	32.6 in

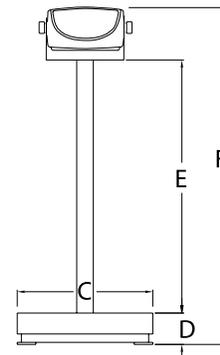
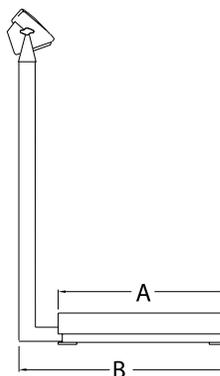

# Ishida iPC Series

Portable Bench Scales

## Standard Features

- Six-digit Liquid Crystal Display (LCD)
- Powered by two "D" cell batteries (up to 500 hours operation)
- Auto power-off function
- Low battery indicator
- Overload stops
- Batteries and AC adapter not included

## Specifications

### Display:

Six digits (7-segment), LCD  
Character height: 1 in (25.4 mm)

### Keyboard:

Zero, tare, on/off, unit (lb/kg)  
NOTE: oz version only displays weight in oz

### Power:

Two dry cell "D" type batteries\* (up to 500 hours) or AC adapter  
Auto power-off function (can be set to 60 min., 20 min., or off)

### Divisions (Auto Ranging):

100 oz: 0.05 oz from 0–50 oz, 0.1 oz from 50–100 oz  
6 lb (3 kg): 0.002 lb (0.001 kg)  
from 0–3 lb (0–1.5 kg), 0.005 lb (0.002 kg)  
from 3–6 lb (1.5–3 kg)  
15 lb (6 kg): 0.005 lb (0.002 kg)  
from 0–6 lb (0–3 kg), 0.01 lb (0.005 kg)  
from 6–15 lb (3–6 kg)  
30 lb (15 kg): 0.01 lb (0.005 kg)  
from 0–15 lb (0–7.5 kg), 0.02 lb (0.01 kg)  
from 15–30 lb (7.5–15 kg)  
60 lb (30 kg): 0.02 lb (0.01 kg)  
from 0–30 lb (0–15 kg), 0.05 lb (0.02 kg)  
from 30–60 lb (15–30 kg)

### Operational Temperature:

23° F to 104° F (-5° C to 40° C)

### Platter Size:

100 oz: (3 kg) 9.1 in x 7.8 in (231 mm x 198.1 mm)  
6 lb (3 kg): 9.1 in x 7.8 in (231 mm x 198.1 mm)  
15 lb (6 kg): 9.1 in x 7.8 in (231 mm x 198.1 mm)  
30 lb (15 kg): 11 in x 11.5 in (279.4 mm x 292.1 mm)  
60 lb (30 kg): 11 in x 11.5 in (279.4 mm x 292.1 mm)

### Warranty:

One-year limited warranty

### Approvals:

NTEP Certified CC 02-139, Class III  
0-30 lb 1500d; 60 lb 1200d; 0-100 oz 1000d  
UL listed



iPC with dual display

## APPROVALS

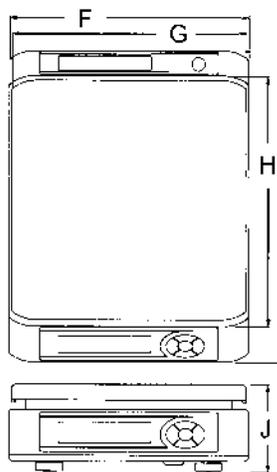

iPC 11" x 11.5" platter

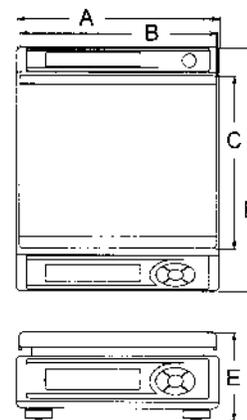

iPC 9.1" x 7.8" platter

DIMENSIONS			
A	9.3 in (236.2 mm)	F	11.3 in (287 mm)
B	9.1 in (231.1 mm)	G	11 in (279.4 mm)
C	7.8 in (198.1 mm)	H	11.5 in (292.1 mm)
D	11.1 in (281.9 mm)	I	14.3 in (363.2 mm)
E	3.9 in (99.1 mm)	J	4 in (101.6 mm)

# Ishida iPC Series

Portable Bench Scales

## Part Number/Price

PART #	CAPACITY	PLATFORM DIMENSIONS	EST. SHIP WEIGHT	PRICE
<b>Single Display</b>				
75466	100 oz	9.1 x 7.8 in	6 lb	\$230.00
<b>Single Display, Multi-ranging</b>				
75454	6 lb (3 kg)	9.1 x 7.8 in	6 lb	230.00
75455	15 lb (6 kg)	9.1 x 7.8 in	6 lb	230.00
75457	30 lb (15 kg)	11 x 11.5 in	8 lb	230.00
75458	60 lb (30 kg)	11 x 11.5 in	8 lb	230.00
<b>Dual Display</b>				
75468	100 oz	9.1 x 7.8 in	6 lb	250.00
<b>Dual Display, Multi-ranging</b>				
75460	6 lb (3 kg)	9.1 x 7.8 in	6 lb	250.00
75461	15 lb (6 kg)	9.1 x 7.8 in	6 lb	250.00
75462	30 lb (15 kg)	11 x 11.5 in	8 lb	250.00
75464	60 lb (30 kg)	11 x 11.5 in	8 lb	250.00

## Options/Accessories

PART #	DESCRIPTION	PRICE
75470	Stainless steel platter cover (100 oz, 6 lb, and 15 lb capacity)	\$20.00
75739	Stainless steel platter cover (30 lb and 60 lb capacity)	20.00
75473	AC adapter	19.00
75889	Additional operating manual	25.00

# Versa-portion®

Compact Scale

## Specifications

### Display:

LED, six digits

### Capacity:

#### RLP-S:

Pound	Gram	Ounce
6.0 x 0.002 lb	3000 x 1g	60.0 x 0.02 oz
15.0 x 0.005 lb	6000 x 2g	150.0 x 0.05 oz
30.0 x 0.01 lb	15000 x 5g	300.0 x 0.1 oz
60.0 x 0.02 lb	30000 x 10g	600.0 x 0.2 oz

#### RPL-SM:

3 kg x 1 g
6 kg x 2 g
15 kg x 5 g
30 kg x 10 g

### Display Indicators:

**RLP-S:** Ounces, grams, pounds, NET, center of zero, battery usage

**RPL-SM:** kg, NET center of zero, battery usage

### Keyboard:

**RLP-S:** Rezero, Tare, On/Off, Unit

**RPL-SM:** Rezero, Tare, On/Off

### Resolution:

Display resolution 1/3,000

Internal resolution 1/90,000

### Operating Humidity:

15 ~ 85% RH

### Operating Temperature:

14° F to 104° F (-10° C to +40° C)

### Power Consumption:

18W when using DC power 3W when using rechargeable battery  
(battery life: 60 hours of continuous usage)

### Power Source:

AC 117/100V, 240/230/220V

DC 12V/1.5A, DC 6V 5Ah rechargeable battery Optional rechargeable battery

### Calibration:

**RLP-S:** Grams

**RPL-SM:** Grams/kilograms

### Dimensions:

#### Overall:

9.9 x 11.4 x 5.3 in (251.6 x 289.7 x 134.6 mm)

#### Package Size:

14.8 x 13.3 x 9.6 in (377 x 337 x 245 mm)

#### Platter Size:

9.3 x 7.8 in (237.2 x 198.0 mm)

### Approximate Weight:

13.9 lb (6.3 kg)

### Warranty:

One-year limited warranty

### Approvals:

#### RLP-S:

NTEP CC 10-068, Class III 3,000d

Measurement Canada AM-5794, Class III 3,000d

#### RPL-SM:

OIML

CE



### APPROVALS - RLP-S



Measurement  
Canada  
Approved

### APPROVALS - RLP-SM



## Standard Features

- Compact design and easy to use
- Water and dust resistant and IP68
- Stainless steel housing with an ABS plastic base
- Removable weigh pan—quick and easy cleaning
- LED Display
- AC adapter included
- Legal for Trade
- Meets HACCP requirements

## Optional Features:

- Rechargeable battery

## Part Number/Price

PART #	DESCRIPTION	CAPACITY	EST. SHIP WEIGHT	PRICE
<b>RLP-S (U.S. Power Cord)</b>				
115125	RPL-6S	6.00 x 0.002 lb	15 lb/6.3 kg	\$400.00
115128	RPL-15S	15.00 x 0.005 lb	15 lb/6.3 kg	400.00
115129	RPL-30S	30.00 x 0.01 lb	15 lb/6.3 kg	400.00
115130	RPL-60S	60.00 x 0.02 lb	15 lb/6.3 kg	400.00
<b>RPL-SM (Euro Power Cord)</b>				
129823	RPL-3SM	3 kg x 1 g	15 lb/6.3 kg	400.00
129824	RPL-6SM	6 kg x 2 g	15 lb/6.3 kg	400.00
129825	RPL-15SM	15 kg x 5 g	15 lb/6.3 kg	400.00
129826	RPL-30SM	30 kg x 10 g	15 lb/6.3 kg	400.00

## Options/Accessories

PART #	DESCRIPTION	PRICE
108516	Rechargeable battery	\$35.00
108518	AC adapter 110-230VAC, US plug	45.00
129953	AC adapter, 110-230 VAC, Euro plug	48.00
115519	Additional Operator guide	10.00



# Ishida IGX and IGB Series

## Specifications

### Capacity:

IGX 150 lb/60 kg x .05 lb/0.02 kg  
 IGX 300 lb/150 kg x .1 lb/0.05 kg  
 IGB 150 lb/60 kg x 0.05 lb/0.02 kg  
 IGB 300 lb/150 kg x 0.1 lb/0.05 kg

### Accuracy:

Configurable 1/3000\*\*, 1/6000, 1/7500

\*\*Legal for Trade setting

### Display:

IGX: Vacuum Fluorescent Display (VFD), 25 mm  
 IGB: Liquid Crystal Display (LCD), 29 mm

### Foot Dimensions:

2 1/1 in dia, 3/4 in height, 2 1/4 in height including stem

### Display Items:

Weight: 5 digits, Center of zero, Tare, Checkweighing: Over "H", Under "L"

### Electrical Power:

IGX: 120V  
 IGB: "D" size batteries or optional AC adapter  
 (batteries not included) 500 hour battery life

### Operating Temperature:

23°F to 109°F (-5°C to 40°C)

### Warranty:

One-year limited warranty

### Approvals:

NTEP CC 05-020, Class III, 3,000d

## Standard Features

- Ability to toggle between lb and kg
- Stainless steel cover with die cast base
- Checkweighing function
- Configurable display resolution: 1/3000, 1/6000, 1/7500  
 (NOTE: Legal for Trade setting is 1/3000)
- 10 PLUs for storing tare, upper limit, lower limit

### IGX:

- Display, VFD
- Power, 120VAC
- Internal buzzer

### IGB:

- Display, LCD
- Power, (2) D-size batteries\* or optional AC adapter
- Selectable automatic power-off function
- Batteries not included

### DRAWING DIMENSIONS

A	15.75 in (400 mm)	E	29.06 in (738 mm)
B	21.65 in (550 mm)	F	22.00 in (560 mm)
C	9.84 in (250 mm)	G	33.70 in (856 mm)
D	5.43 in (138 mm)		



## APPROVALS



## Part Number/Price

PART #	CAPACITY	PLATFORM DIMENSIONS	EST. SHIP WEIGHT	PRICE
<b>IGX</b>				
84989	150 lb/60 kg x 0.05 lb/0.02 kg	15.75 x 21.65 x 5.43 in	43 lb	\$695.00
84990	300 lb/150 kg x 0.1 lb/0.05 kg	15.75 x 21.65 x 5.43 in	43 lb	695.00
<b>IGB</b>				
84991	150 lb/60 kg x 0.05 lb/0.02 kg	15.75 x 21.65 x 5.43 in	41 lb	595.00
84992	300 lb/150 kg x 0.1 lb/0.05 kg	15.75 x 21.62 x 5.43 in	41 lb	595.00

## Options/Accessories

PART #	DESCRIPTION	PRICE
75473	AC adapter (IGB only)	\$19.00
86545	Additional operating manual (IGX/IGB)	25.00

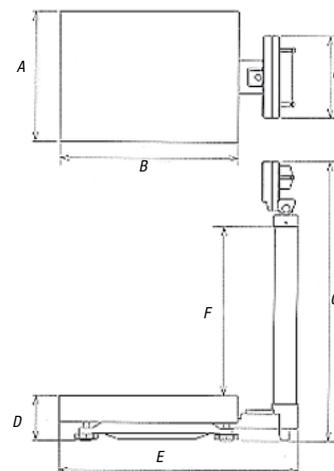



# Checkweighers

## Table of Contents

<b>IQ plus® 2100</b> .....	<b>190</b>
Digital Bench Scale	
<b>IQ plus® 2100SL</b> .....	<b>192</b>
Digital Bench Scale	
<b>CW-90</b> .....	<b>194</b>
Over/Under Checkweigher	
<b>CW-90X</b> .....	<b>196</b>
Over/Under Checkweigher Washdown	

**ESPAÑOL** | Visit [ricelake.com/spanish](http://ricelake.com/spanish)  
to see all RLWS materials  
available in Spanish

Product names, logos, brands, and other trademarks featured  
or referred to within this publication are the property of their respective trademark holders.

# IQ plus® 2100

Digital Bench Scale

## Specifications

**Line Voltages:**

115 or 230VAC

**Frequency:**

50 or 60 Hz

**Power Consumption:**

70 mA at 115VAC (8W)

35 mA at 230VAC (8W)

**Display Resolution:**

10,000 dd

**Digital Inputs:**

Two inputs, TTL or switch closure, active-low

**Digital Filter:**

Software selectable

**Serial Communications:**

Full duplex RS-232; 9600, 4800, 2400, 1200 bps; seven or eight data bits; even, odd, or no parity

**Display:**

Six-digit Light Emitting Diode (LED) display. Seven-segment, 0.8 in (20 mm) digits

**LED Annunciators:**

Negative value, center of zero, motion, kg, g, lb, oz

**Keypad:**

Two stainless steel piezo switches

**Operating Temperature:**

14°F to 104°F (-10°C to 40°C)

**Rating/Material:**

NEMA 4X/IP66, stainless steel

**Warranty:**

Two-year limited warranty

**Approvals:**

Indicator: NTEP CC 00-045 Class III/IIIL 10,000d

Measurement Canada AM-5374;

UL and C-UL listed

Base: NTEP CC 95-072, Class III 5,000d



## APPROVALS



Measurement  
Canada  
Approved

Meets USDA  
Requirements

## Standard Features

- NEMA 4X/IP66
- 304 stainless steel construction
- Large, bold 0.8 in Light Emitting Diode (LED) Display
- Status annunciators: lb, kg, oz, g, negative, motion, center of zero
- One full duplex RS-232 port
- Two digital inputs for remote zero, print and units
- 12 in column, attachment bracket or tilt stand for table, wall or under counter mounting
- Aluminum, single point load cell
- Overload and upload stops on scale base
- Stainless steel, non-tactile feel, piezo zero and units buttons
- Unit of Measure: kg, gm, lb, oz, lb/oz (lb/oz is not Legal for Trade)
- PreVent™ breather vent

PLATFORM DIMENSIONS	L	L1
10 x 10 in (254 x 254 mm)	10.25 in (260.4 mm)	10 in (254 mm)
12 x 12 in (304.8 x 304.8 mm)	12.25 in (311.2 mm)	12 in (304.8 mm)

See BenchMark® Series – Stainless Steel for 12 x 18 in, 18 x 18 in, 18 x 24 in, and 24 x 24 in detailed platform dimensions

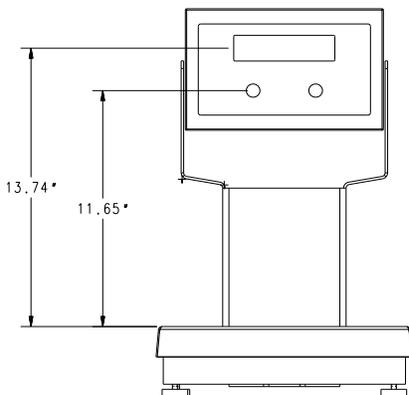
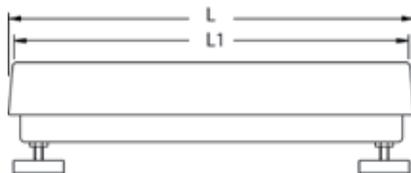

With 12 in column

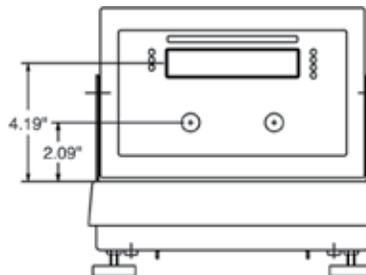

With attachment bracket

## Part Number/Price

PART #	PLATFORM SIZE*	CAPACITY (LB/KG/G/OZ)	EST. SHIP WEIGHT	PRICE
<b>IQ plus 2100 with tilt stand - 115 VAC</b>				
63053	10 x 10 in	5 x 0.001 lb, 2.5 x 0.0005 kg/ 2,500 x 0.5 g/80 x 0.02 oz	23 lb	\$1,035.00
63052	10 x 10 in	10 x 0.002 lb/5 x 0.001 kg/ 5,000 x 1 g/160 x 0.05 oz	23 lb	1,035.00
63051	10 x 10 in	25 x 0.005 lb/10 x 0.002 kg/ 10,000 x 2 g/400 x 0.10 oz	23 lb	1,035.00
63050	12 x 12 in	50 x 0.01 lb/25 x 0.005 kg/ 25,000 x 5 g/800 x 0.20 oz	26 lb	1,145.00
63049	12 x 12 in	100 x 0.02 lb/50 x 0.01 kg/ 50,000 x 10 g/1,600 x 0.50 oz	26 lb	1,145.00
<b>IQ plus 2100 with attachment bracket - 115 VAC</b>				
63043	10 x 10 in	5 x 0.001 lb/2.5 x 0.0005 kg/ 2,500 x 0.5 g/80 x 0.02 oz	23 lb	1,065.00
63042	10 x 10 in	10 x 0.002 lb/5 x 0.001 kg/ 5,000 x 1 g/160 x 0.05 oz	23 lb	1,065.00
63041	10 x 10 in	25 x 0.005 lb/10 x 0.002 kg/ 10,000 x 2 g/400 x 0.10 oz	23 lb	1,065.00
63040	12 x 12 in	50 x 0.01 lb/25 x 0.005 kg/ 25,000 x 5 g/800 x 0.20 oz	26 lb	1,180.00
63039	12 x 12 in	100 x 0.02 lb/50 x 0.01 kg/ 50,000 x 10 g/1,600 x 0.50 oz	26 lb	1,180.00
<b>IQ plus 2100 with 12 in column - 115 VAC</b>				
63048	10 x 10 in	5 x 0.001 lb, 2.5 x 0.0005 kg/ 2,500 x 0.5 g/80 x 0.02 oz	25 lb	1,140.00
63047	10 x 10 in	10 x 0.002 lb/5 x 0.001 kg/ 5,000 x 1 g/160 x 0.05 oz	25 lb	1,140.00
63046	10 x 10 in	25 x 0.005 lb/10 x 0.002 kg/ 10,000 x 2 g/400 x 0.10 oz	25 lb	1,140.00
63045	12 x 12 in	50 x 0.01 lb/25 x 0.005 kg/ 25,000 x 5 g/800 x 0.20 oz	28 lb	1,250.00
63044	12 x 12 in	100 x 0.02 lb/50 x 0.01 kg/ 50,000 x 10 g/1,600 x 0.50 oz	28 lb	1,250.00
<b>IQ plus 2100 with 12 in column - 230 VAC</b>				
63063	10 x 10 in	5 x 0.001 lb/2.5 x 0.0005 kg/ 2,500 x 0.5 g/80 x 0.02 oz	25 lb	1,140.00
63062	10 x 10 in	10 x 0.002 lb/5 x 0.001 kg/ 5,000 x 1 g/160 x 0.05 oz	25 lb	1,140.00
63061	10 x 10 in	25 x 0.005 lb/10 x 0.002 kg/ 10,000 x 2 g/400 x 0.10 oz	25 lb	1,140.00
63060	12 x 12 in	50 x 0.01 lb/25 x 0.005 kg/ 25,000 x 5 g/800 x 0.20 oz	28 lb	1,250.00
63059	12 x 12 in	100 x 0.02 lb/50 x 0.01 kg/ 50,000 x 10 g/1,600 x 0.50 oz	28 lb	1,250.00
<b>IQ plus 2100 with 18 in column - 115 VAC</b>				
72476	12 x 18 in	50 x 0.01 lb/25 x 0.005 kg/ 25,000 x 5 g/800 x 0.02 oz	37 lb	1,665.00
72477	12 x 18 in	100 x 0.02 lb/50 x 0.01 kg/ 50,000 x 10 g/1,600 x 0.50 oz	37 lb	1,665.00
72478	18 x 18 in	50 x 0.01 lb/25 x 0.005 kg/ 25,000 x 5 g/800 x 0.02 oz	68 lb	2,245.00
72479	18 x 18 in	150 x 0.05 lb/75 x 0.02 kg/ 75,000 x 20 g/2,400 x 0.50 oz	68 lb	2,245.00
72480	18 x 18 in	300 x 0.1 lb/150 x 0.05 kg/ 150,000 x 50 g/4,800 x 1 oz	68 lb	2,245.00
72481	18 x 18 in	500 x 0.1 lb/250 x 0.05 kg/ 250,000 x 50 g/8,000 x 2 oz	68 lb	2,245.00
72482	18 x 24 in	50 x 0.01 lb/25 x 0.005 kg/ 25,000 x 5 g/800 x 0.02 oz	78 lb	2,465.00
72483	18 x 24 in	150 x 0.05 lb/75 x 0.02 kg/ 75,000 x 20 g/2,400 x 0.50 oz	78 lb	2,465.00
72484	18 x 24 in	300 x 0.1 lb/150 x 0.05 kg/ 150,000 x 50 g/4,800 x 1 oz	78 lb	2,465.00
72485	18 x 24 in	500 x 0.1 lb/250 x 0.05 kg/ 250,000 x 50 g/8,000 x 2 oz	78 lb	2,465.00
72486	18 x 24 in	1000 x 0.2 lb/500 x 0.1 kg/ 500,000 x 100 g/16,000 x 5 oz	78 lb	2,465.00
72487	24 x 24 in	150 x 0.05 lb/75 x 0.02 kg/ 75,000 x 20 g/2,400 x 0.50 oz	84 lb	2,595.00
72488	24 x 24 in	300 x 0.1 lb/150 x 0.05 kg/ 150,000 x 50 g/4,800 x 1 oz	84 lb	2,595.00
72489	24 x 24 in	500 x 0.1 lb/250 x 0.05 kg/ 250,000 x 50 g/8,000 x 2 oz	84 lb	2,595.00
72490	24 x 24 in	1000 x 0.2 lb/500 x 0.1 kg/ 500,000 x 100 g/16,000 x 5 oz	84 lb	2,595.00

## Options/Accessories

PART #	DESCRIPTION	PRICE
53001	304 stainless steel clamshell for added load cell protection	\$125.00
64123	Remote switch for zero, units, and print (non-washdown)	77.50
N/A	RL1310 Stainless steel load cell (replacing standard aluminum load cell on 10x10 or 12x12 bases only)	+85.00 list price adder
N/A***	18 in column replacing standard 12 in column	+50.00 list price adder
53415	Additional operation manual	30.00

\* To convert inches to millimeters: Multiply inch measurement by 25.4

\*\*\* Not recommended for use with scale bases smaller than 12 in x 12 in

# IQ plus® 2100SL

Digital Bench Scale

## Specifications

### Line Voltages:

115 or 230VAC

### Frequency:

50 or 60Hz

### Power Consumption:

70 mA at 115VAC (8W)

35 mA at 230VAC (8W)

### Display Resolution:

10,000 dd

### Digital Inputs:

Two inputs, TTL or switch closure, active-low

### Digital Filter:

Software selectable

### Serial Communications:

Full duplex RS-232; 9600, 4800, 2400, 1200 bps; seven or eight data bits; even, odd, or no parity

### Display:

Six-digit Light Emitting Diode (LED) display, seven-segment, 0.8 in (20 mm) digits

### LED Annunciators:

Negative value, center of zero, motion, kg, g, lb, oz

### Keypad:

Two stainless steel piezo switches

### Operating Temperature:

14°F to 104°F (-10°C to 40°C)

### Rating/Material:

NEMA 4X/IP66, stainless steel

### Warranty:

Two-year limited warranty

### Approvals:

Indicator: NTEP CC 00-045 Class III/IIIL 10,000d

Measurement Canada, AM-5374;

UL and C-UL listed

Base: NTEP CC 95-072, Class III 5,000d;



IQ plus 2100SL with attachment bracket



IQ plus 2100 with column



IQ plus 2100 with tilt stand

See BenchMark® SL Series catalog page for base specifications

## APPROVALS



Measurement  
Canada  
Approved

Meets USDA  
Requirements

## Standard Features

- NEMA 4X/IP66
- 304 stainless steel construction
- Large, bold 0.8 in Light Emitting Diode (LED) display
- Status annunciators: lb, kg, oz, g, negative, motion, center of zero
- One full duplex RS-232 port
- Two digital inputs for remote zero, print and units
- 12 in column, attachment bracket or tilt stand for table, wall or under counter mounting
- Aluminum, single point load cell
- Overload and upload stops on scale base
- Stainless steel, non-tactile feel, piezo zero and units buttons
- Unit of Measure: kg, gm, lb, oz, lb/oz (lb/oz is not Legal for Trade)
- PreVent™ breather vent
- Spring loaded platform

PLATFORM DIMENSIONS	L	L1
10 x 10 in ( 254 x 254 mm)	10.25 in (260.4 mm)	10 in (254 mm)
12 x 12 in (304.8 x 304.8 mm)	12.25 in (311.2 mm)	12 in (304.8 mm)

See BenchMark Series—Stainless Steel for 12 x 18 in, 18 x 18 in, 18 x 24 in and 24 x 24 in detailed platform dimensions

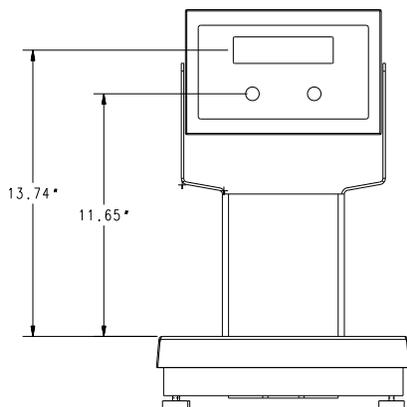
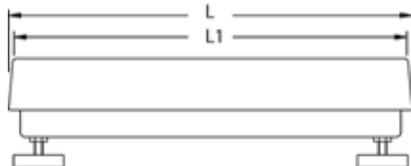

With 12 in column

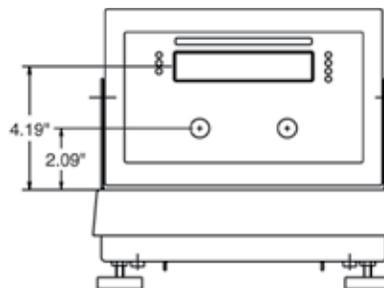

# IQ plus® 2100SL

Digital Bench Scale

## Part Number/Price

PART #	PLATFORM SIZE*	CAPACITY (LB/KG/G/OZ)	EST. SHIP WEIGHT	PRICE
<b>IQ plus 2100SL with tilt stand - 115 VAC</b>				
65168	10 x 10 in	5 x 0.001 lb/2.5 x 0.0005 kg/ 2,500 x 0.5 g/80 x 0.02 oz	21 lb	\$1,160.00
65169	10 x 10 in	10 x 0.002 lb/5 x 0.001 kg/ 5,000 x 1 g/160 x 0.05 oz	21 lb	1,160.00
65170	10 x 10 in	20 x 0.005 lb/10 x 0.002 kg/ 10,000 x 2 g/320 x 0.1 oz	21 lb	1,160.00
65171	10 x 10 in	30 x 0.01 lb/15 x 0.005 kg/ 15,000 x 5 g/480 x 0.1 oz	21 lb	1,160.00
65172	12 x 12 in	30 x 0.01 lb/15 x 0.005 kg/ 15,000 x 5 g/480 x 0.1 oz	24 lb	1,235.00
65173	12 x 12 in	50 x 0.01 lb/25 x 0.005 kg/ 25,000 x 5 g/800 x 0.20 oz	24 lb	1,265.00
65174	12 x 12 in	100 x 0.02 lb/50 x 0.01 kg/ 50,000 x 10 g/1600 x 0.50 oz	24 lb	1,265.00
<b>IQ plus 2100SL with attachment bracket - 115 VAC</b>				
65175	10 x 10 in	5 x 0.001 lb/2.5 x 0.0005 kg/ 2,500 x 0.5 g/80 x 0.02 oz	21 lb	1,190.00
65176	10 x 10 in	10 x 0.002 lb/5 x 0.001 kg/ 5,000 x 1 g/160 x 0.05 oz	21 lb	1,190.00
65177	10 x 10 in	20 x 0.005 lb/10 x 0.002 kg/ 10,000 x 2 g/320 x 0.1 oz	21 lb	1,190.00
65178	10 x 10 in	30 x 0.01 lb/15 x 0.005 kg/ 15,000 x 5 g/480 x 0.1 oz	21 lb	1,190.00
65179	12 x 12 in	30 x 0.01 lb/15 x 0.005 kg/ 15,000 x 5 g/480 x 0.1 oz	24 lb	1,265.00
65180	12 x 12 in	50 x 0.01 lb/25 x 0.005 kg/ 25,000 x 5 g/800 x 0.20 oz	24 lb	1,300.00
65181	12 x 12 in	100 x 0.02 lb/50 x 0.01 kg/ 50,000 x 10 g/1600 x 0.50 oz	24 lb	1,300.00
<b>IQ plus 2100SL with 12 in column - 115 VAC</b>				
65182	10 x 10 in	5 x 0.001 lb/2.5 x 0.0005 kg/ 2,500 x 0.5 g/80 x 0.02 oz	23 lb	1,260.00
65183	10 x 10 in	10 x 0.002 lb/5 x 0.001 kg/ 5,000 x 1 g/160 x 0.05 oz	23 lb	1,260.00
65184	10 x 10 in	20 x 0.005 lb/10 x 0.002 kg/ 10,000 x 2 g/320 x 0.1 oz	23 lb	1,260.00
65185	10 x 10 in	30 x 0.01 lb/15 x 0.005 kg/ 15,000 x 5 g/480 x 0.1 oz	23 lb	1,260.00
65186	12 x 12 in	30 x 0.01 lb/15 x 0.005 kg/ 15,000 x 5 g/480 x 0.1 oz	26 lb	1,340.00
65187	12 x 12 in	50 x 0.01 lb/25 x 0.005 kg/ 25,000 x 5 g/800 x 0.20 oz	26 lb	1,375.00
65188	12 x 12 in	100 x 0.02 lb/50 x 0.01 kg/ 50,000 x 10 g/1600 x 0.50 oz	26 lb	1,375.00

## Options/Accessories

PART #	DESCRIPTION	PRICE
53001	304 stainless steel clamshell for added load cell protection	\$125.00
64123	Remote switch for zero, units and print (non-washdown)	77.50
N/A	RL1380 stainless steel load cell (replacing standard aluminum load cell)	+85.00 list price adder
N/A***	18 in column replacing standard 12 in column	+50.00 list price adder
53415	Additional operation manual	30.00

\* To convert inches to millimeters: Multiply inch measurement by 25.4

\*\*\* Not recommended for use with scale bases smaller than 12 in x 12 in

CHECKWEIGHERS

www.ricelake.com | Phone: 800-472-6703

RICE LAKE

# CW-90

Over/Under Checkweigher

## Specifications

**Power - AC:**

Line voltages: 115/230VAC  
Frequency: 50/60 Hz

**Power Consumption:**

1.5A at 115VAC (8W),  
0.75A at 230VAC (8W)

**Excitation Voltage:**

+5VDC 8 x 350Ω or 16 x 700Ω load cells

**Analog Signal Input Range:**

-0.5 mV/V - 4.5 mV/V

**Analog Signal Sensitivity:**

0.3 uV/graduation minimum, 1.5 uV/ graduation recommended

**Measurement Rate:**

960,480,240,120,60,30,15,7.5 per second

**System Linearity:**

+/- 0.01% full scale

**Digital I/O:**

Four channels on CPU board

**Circuit Protection:**

RFI, EMI, ESD protection

**Display:**

Large 0.8 in 14 segment, six digit high-intensity red LED display

**Status Annunciators:**

Designators for %, kg, gm, lb, oz, center of zero, G/B, N, T, PT, neg, motion

**Operating Temperature:**

Legal: 14°F to 104°F (-10°C to 40°C)

**Rating/Material:**

IP66, stainless steel

**Display Resolution:**

100,000 graduations maximum

**Load Cell:**

Aluminum, environmentally sealed

**Warranty:**

Two-year limited warranty

**Approvals:**

Indicator: NTEP CC 08-092, Class III/IIIL 10,000d  
Measurement Canada AM-5710, Class III 10,000d  
OIML R76/2006-GBI-10.02  
TC GB-1385  
TAC UK2900  
UL and CUL listed  
CE marked  
Scale: NTEP CC 95-072, Class III 5,000d  
Measurement Canada AM-5082, Class III 5,000d  
NSF



**WeighVault**  
**REVOLUTION**  
SCALE SOFTWARE

## APPROVALS



Measurement  
Canada  
Approved



## Standard Features

- Membrane keypad consisting of ZERO, UNITS, PRINT, TARE, OVER, UNDER, ID, TARGET, 0-9, CLEAR, DECIMAL, ENTER, MENU, POWER
  - 304 stainless steel, IP66 rated indicator
  - PreVent™ breather vent
  - Storage for up to 50 ID's
  - Unit of Measure: kg, gm, lb, oz, lb/oz (lb/oz is not Legal for Trade)
  - High-Intensity LED display
  - Battery backed time and date
  - Two full duplex RS-232 serial ports
  - Configurable print formats
  - Audit trail tracking
  - Optional communications: Ethernet, USB or Fiber Optic
  - Four configurable Digital I/O
  - Reflash memory to upgrade firmware
- Scale:**
- Aluminum, environmentally sealed load cell
  - 304 stainless steel
  - Five point overload protection



# CW-90

Over/Under Checkweigher

## Part Number/Price

PART #	CAPACITY	PLATFORM DIMENSIONS	COLUMN HEIGHT	EST. SHIP WEIGHT	PRICE
<b>115 VAC</b>					
105957†	5 x 0.001 lb (2.5 x 0.0005 kg) or 80 x 0.02 oz	10 x 10 x 4.25 in	12 in	29 lb	\$1,325.00
105958†	10 x 0.002 lb (5 x 0.001 kg) or 160 x 0.05 oz	10 x 10 x 4.25 in	12 in	29 lb	1,325.00
105959†	25 x 0.005 lb (10 x 0.002 kg) or 400 x 0.1 oz	10 x 10 x 4.25 in	12 in	29 lb	1,325.00
105960†	25 x 0.005 lb (10 x 0.002 kg) or 400 x 0.1 oz	12 x 12 x 4.25 in	12 in	33 lb	1,435.00
105961†	50 x 0.01 lb (25 x 0.005 kg) or 800 x 0.2 oz	12 x 12 x 4.25 in	12 in	33 lb	1,435.00
105962†	100 x 0.02 lb (50 x 0.01 kg) or 1600 x 0.5 oz	12 x 12 x 4.25 in	12 in	33 lb	1,435.00
<b>230 VAC CE marked/OIML approved</b>					
106123††	3 x 0.001 kg	254 x 254 x 108 mm	305 mm	13.2 kg	1,325.00
106124††	6 x 0.002 kg	254 x 254 x 108 mm	305 mm	13.2 kg	1,325.00
106125††	15 x 0.005 kg	254 x 254 x 108 mm	305 mm	13.2 kg	1,325.00
106126††	15 x 0.005 kg	305 x 305 x 108 mm	305 mm	15 kg	1,435.00
106127††	30 x 0.01 kg	305 x 305 x 108 mm	305 mm	15 kg	1,435.00
106128††	60 x 0.02 kg	305 x 305 x 108 mm	305 mm	15 kg	1,435.00
<b>230 VAC</b>					
118891†	2.5 x 0.0005 kg (5 lb x 0.001 lb) or 80 x 0.02 oz	10 x 10 x 4.25 in	12 in	29 lb	1,325.00
118892†	5 x 0.001 kg (10 lb x 0.002 lb) or 160 x 0.05 oz	10 x 10 x 4.25 in	12 in	29 lb	1,325.00
118893†	10 x 0.002 kg (25 lb x 0.005 lb) or 400 x 0.1 oz	10 x 10 x 4.25 in	12 in	29 lb	1,325.00
118895†	10 x 0.002 kg (25 lb x 0.005 lb) or 400 x 0.1 oz	12 x 12 x 4.25 in	12 in	33 lb	1,435.00
118896†	25 x 0.005 kg (50 lb x 0.01 lb) or 800 x 0.2 oz	12 x 12 x 4.25 in	12 in	33 lb	1,435.00
118897†	50 x 0.01 kg (100 lb x 0.02 lb) or 1600 x 0.5 oz	12 x 12 x 4.25 in	12 in	33 lb	1,435.00



## Options/Accessories

PART #	DESCRIPTION	PRICE
77142	Ethernet TCP/IP	\$400.00
108671	Wireless LAN card WiFi 802.11 A/B	570.00
93245	USB Port (PC connection only) cable included	160.00
95357	USB cable, Type A to mini-B, 1 meter	5.00
96736	Fiber optic board	200.00
78026	Fiber optic, duplex cable 100 ft	135.00
80892	Fiber optic cutter	9.00
117358	WeighVault™ for CW-90 software (requires part number 77142 or 108671)	200.00

\*To convert inches to millimeters: Multiply inch measurement by 25.4

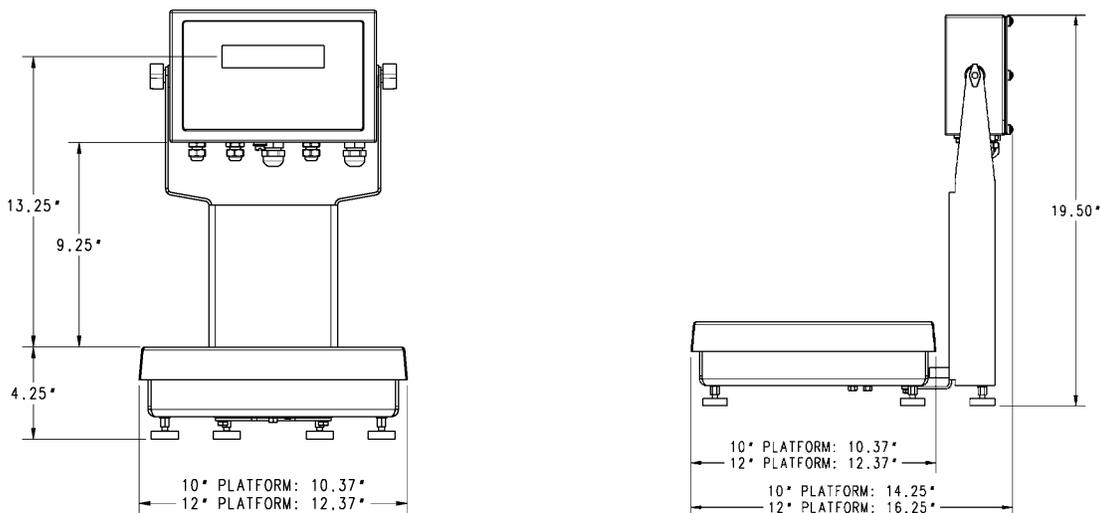

# CW-90X

Over/Under Checkweigher Washdown

## Specifications

### Power-AC:

Line voltages: 115/230VAC  
Frequency: 50/60 Hz

### Power Consumption:

1.5A at 115VAC (8W),  
0.75A at 230VAC (8W)

### Excitation Voltage:

+5VDC 8 x 350  $\Omega$  or  
16 x 700  $\Omega$  load cells

### Analog Signal Input Range:

-0.5 mV/V - 4.5 mV/V

### Analog Signal Sensitivity:

0.3  $\mu$ V/graduation minimum, 1.5  $\mu$ V/ graduation recommended

### Measurement Rate:

960, 480, 240, 120, 60, 30, 15, 7.5 per second

### System Linearity:

+/- 0.01% full scale

### Digital I/O:

Four channels on CPU board

### Circuit Protection:

RFI, EMI, ESD protection

### Display:

Large 0.8 in 14 segment, six digit high-intensity red LED display

### Status Annunciators:

Designators for %, kg, gm, lb, oz, center of zero, G/B, N, T, PT, neg, motion

### Operating Temperature:

Legal: 14°F to 104°F (-10°C to 40°C)

### Rating/Material:

IP69K, stainless steel

### Display Resolution:

100,000 graduations maximum

### Load Cell:

IP69K, stainless steel hermetically sealed

### Warranty:

Three-year limited warranty

### Approvals:

Indicator: NTEP CC 08-092, Class III/IIIL 10,000d  
Measurement Canada AM-5710, Class III 10,000d  
OIML R76/2006-GBI-10.02  
TC GB-1385  
TAC UK2900  
UL and CUL listed  
CE marked  
Scale: NTEP CC 95-072, Class III 5,000d  
Measurement Canada AM-5082, Class III 5,000d  
NSF



## APPROVALS



Measurement  
Canada  
Approved



## Standard Features

- Piezo keypad consisting of ZERO, UNITS, PRINT, TARE, OVER, UNDER, ID, TARGET, ENTER, MENU, POWER
- 304 stainless steel, IP69K rated indicator
- PreVent breather vent
- Storage for up to 50 ID's
- Unit of measure: kg, gm, lb, oz, lb/oz (lb/oz is not Legal for Trade)
- High-Intensity LED display
- Battery backed time and date
- Two full duplex RS-232 serial ports
- Configurable print formats
- Audit trail tracking
- Optional communications: Ethernet, USB or Fiber Optic
- Four configurable Digital I/O
- Reflash memory to upgrade firmware

### Scale:

- IP69K, stainless steel hermetically sealed load cell
- 304 stainless steel
- Five point overload protection

# CW-90X

Over/Under Checkweigher Washdown

## Part Number/Price

PART #	CAPACITY	PLATFORM DIMENSIONS	COLUMN HEIGHT	EST. SHIP WEIGHT	PRICE
<b>115 VAC</b>					
105963 †	5 x 0.001 lb (2.5 x 0.0005 kg) or 80 x 0.02 oz	10 x 10 x 4.25 in	12 in	29 lb	\$1,530.00
105965 †	10 x 0.002 lb (5 x 0.001 kg) or 160 x 0.05 oz	10 x 10 x 4.25 in	12 in	29 lb	1,530.00
105966 †	25 x 0.005 lb (10 x 0.002 kg) or 400 x 0.1 oz	10 x 10 x 4.25 in	12 in	29 lb	1,530.00
105967 †	25 x 0.005 lb (10 x 0.002 kg) or 400 x 0.1 oz	12 x 12 x 4.25 in	12 in	33 lb	1,645.00
105968 †	50 x 0.01 lb (25 x 0.005 kg) or 800 x 0.2 oz	12 x 12 x 4.25 in	12 in	33 lb	1,645.00
105969 †	100 x 0.02 lb (50 x 0.01 kg) or 1600 x 0.5 oz	12 x 12 x 4.25 in	12 in	33 lb	1,645.00
<b>230 VAC CE marked/OIML approved</b>					
106129 ††	3 x 0.001 kg	254 x 254 x 108 mm	305 mm	13.2 kg	1,530.00
106130 ††	6 x 0.002 kg	254 x 254 x 108 mm	305 mm	13.2 kg	1,530.00
106131 ††	15 x 0.005 kg	254 x 254 x 108 mm	305 mm	13.2 kg	1,530.00
106132 ††	15 x 0.005 kg	305 x 305 x 108 mm	305 mm	15 kg	1,645.00
106133 ††	30 x 0.01 kg	305 x 305 x 108 mm	305 mm	15 kg	1,645.00
106134 ††	60 x 0.02 kg	305 x 305 x 108 mm	305 mm	15 kg	1,645.00
<b>230 VAC</b>					
118899 †	2.5 x 0.0005 kg (5 lb x 0.001 lb) or 80 x 0.02 oz	10 x 10 x 4.25 in	12 in	29 lb	1,530.00
118900 †	5 x 0.001 kg (10 lb x 0.002 lb) or 160 x 0.05 oz	10 x 10 x 4.25 in	12 in	29 lb	1,530.00
118901 †	10 x 0.002 kg (25 lb x 0.005 lb) or 400 x 0.1 oz	10 x 10 x 4.25 in	12 in	29 lb	1,530.00
118902 †	10 x 0.002 kg (25 lb x 0.005 lb) or 400 x 0.1 oz	12 x 12 x 4.25 in	12 in	33 lb	1,645.00
118903 †	25 x 0.005 kg (50 lb x 0.01 lb) or 800 x 0.2 oz	12 x 12 x 4.25 in	12 in	33 lb	1,645.00
118904 †	50 x 0.01 kg (100 lb x 0.02 lb) or 1600 x 0.5 oz	12 x 12 x 4.25 in	12 in	33 lb	1,645.00



## Options/Accessories

PART #	DESCRIPTION	PRICE
77142	Ethernet TCP/IP	\$400.00
108671	Wireless LAN card WiFi 802.11 A/B	570.00
93245	USB Port (PC connection only) cable included	160.00
95357	USB cable, Type A to mini-B, 1 meter	5.00
96736	Fiber optic board	200.00
78026	Fiber optic, duplex cable 100 ft	135.00
80892	Fiber optic cutter	9.00
117358	WeighVault™ for CW-90 software (requires part number 77142 or 108671)	200.00

\* To convert inches to millimeters: Multiply inch measurement by 25.4

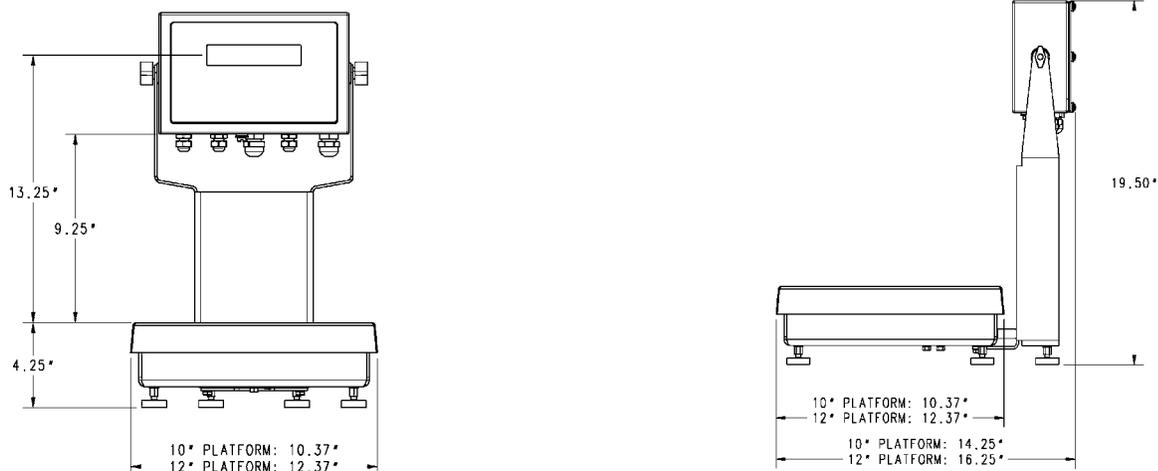



# Concrete Batch Controllers

Table of Contents

**CB-2 Concrete Batch Controller ..... 200**  
Multi-Scale Automated Batching System

**ESPAÑOL** | Visit [ricelake.com/spanish](http://ricelake.com/spanish)  
to see all RLWS materials  
available in Spanish

Product names, logos, brands, and other trademarks featured  
or referred to within this publication are the property of their respective trademark holders.

# CB-2 Concrete Batch Controller

Multi-Scale Automated Batching System

## Specifications

### Materials:

Eight single speed aggregates or four dual speed  
Eight single or four dual speed cements  
Hot & cold metered or weighed water delivered in two additions  
Six metered admixtures configurable as bottle or direct feed

### 1 Megabyte Data Storage:

2200 mix designs, 750 customers, 125 trucks, 99 materials, 400 orders

### State Modes:

MnDOT

### Line Voltages:

115 or 230VAC

### Frequency:

50 or 60 Hz

### Power Consumption:

340 mA, maximum @ 115VAC (26W) / 240 mA @ 230VAC (26W)

### Full Scale Input Signal:

Up to 40 mV

### Excitation Voltage:

10 ± 0.5VDC, 16 x 350Ω or 32 x 700Ω load cells per A/D card

### Sense Amplifier:

Differential amplifier with 4 and 6 wire sensing

### Analog Signal Input Range:

-10 mV to +40 mV

### Analog Signal Sensitivity:

0.3 μV/graduation minimum @ 7.5 Hz

1.0 μV/graduation typical @ 120 Hz

4.0 μV/graduation typical @ 960 Hz

### A/D Sample Rate:

7.5 to 960 Hz, software selectable (120 recommended)

### Input Impedance:

>35 M typical

### Internal Resolution:

8 million counts/8 million 23 bit

### Weight Display Resolution:

9,999,999

### Input Sensitivity:

10 nV per internal count

### System Linearity:

±0.01% full scale

### Zero Stability:

±150 nV/°C, maximum

### Span Stability:

±3.5 ppm/°C, maximum

### Calibration Method:

Software, contents stored in flash memory

### Input Voltage Differential:

±800 mV referenced to earth ground

### Input Overload:

Load cell signal lines ±10V continuous, ESD protected

### RFI/EMI Protection:

Signal, excitation and sense lines protected

### Analog Output:

Option card: 16 bit resolution DAC

Load resistance: 1.1 KΩ minimum

Voltage output: 0–10VDC

Current output: 0–20 mA

External loop resistance: 840 Ω maximum

### Microcomputer:

Motorola ColdFire® MCF5307 main processor at 90 MHz

### Digital I/O:

Six I/O channels on CPU board; optional 24-channel I/O expansion boards available

### Digital Filter:

Software selectable: 1–256, enhanced RATTLETRAP® hybrid digital filtering



Note: Factory field installation required, minimum three days on site

## Specifications Continued

### Serial Ports:

Four ports on CPU board support up to 115,200 bps; optional dual-channel serial expansion boards available

Port 1: Full duplex RS-232

Port 2: RS-232 with CTS/RTS via DB-9 connector; PS/2 keyboard interface

Port 3: Full duplex RS-232, 20 mA output

Port 4: Full duplex RS-232, 2-wire RS-485, 20 mA output

### Display:

4.6 in W x 3.4 in H (116 W x 86 mm H), 320 x 240 pixel VGA Liquid Crystal Display (LCD) module with adjustable contrast, 75 Hz scan rate 26,000 cd/m<sup>2</sup> brightness

### Keyboard:

27-key membrane panel, PS/2 port for external keyboard connection

### Warranty:

Two-year limited warranty

## Standard Features

- One aggregate and one cement scale, water scale is standard for 93503/93504
- Manual override controls
- Batch tickets with configurable field printing
- 1 megabyte data storage
- Material usage by day/week/month/year and inventory on-hand with reporting
- Automatic aeration control for cement silos and weigh hoppers
- Multiple freefall values per material
- Split batching for loads larger than plant capacity with pre-weighing next batch for maximum throughput
- Automatic dust collection outputs
- Order or load based batching
- US standard or metric (SI) operation
- Aggregate conveyor/skiphoist controls
- Loss in weight aggregate dispensing
- Four dual or eight single speed aggregates
- Four dual or eight single speed cements
- Weighed water with water reservoir
- Four or eight auxiliary manual controls
- Continuous batching with mixer controls for central mix block or precast plants

## Optional Features

- Dual moisture probe interface (supports 4-20 mA or 0-10V probes)
- Ethernet TCP/IP
- Spanish user program

# CB-2 Concrete Batch Controller

Multi-Scale Automated Batching

## Part Number/Price

PART#	DESCRIPTION	EST. SHIP WEIGHT	PRICE
93501	CB-2 Concrete Batching Controller Metered Water/Four Cement/Eight Aggregate/Six Admix 115VAC	180lb	\$19,565.00
93502	CB-2 Concrete Batching Controller Metered Water/Four Cement/Eight Aggregate/Six Admix 230VAC	180lb	19,565.00
93503	CB-2 Concrete Batching Controller Weighed Water/Four Cement/Eight Aggregate/Six Admix 115VAC	180lb	19,565.00
93504	CB-2 Concrete Batching Controller Weighed Water/Four Cement/Eight Aggregate/Six Admix 230VAC	180lb	19,565.00
FLD-INST	Factory field installation required, minimum three days on site		3,960.00

## Options/Accessories

PART #	DESCRIPTION	PRICE
93511	Dual moisture probe Input (factory installed option)	\$520.00
110783	Load mix designs and test prior to shipping	N/C
113872	Phone support (4 hours)	395.00

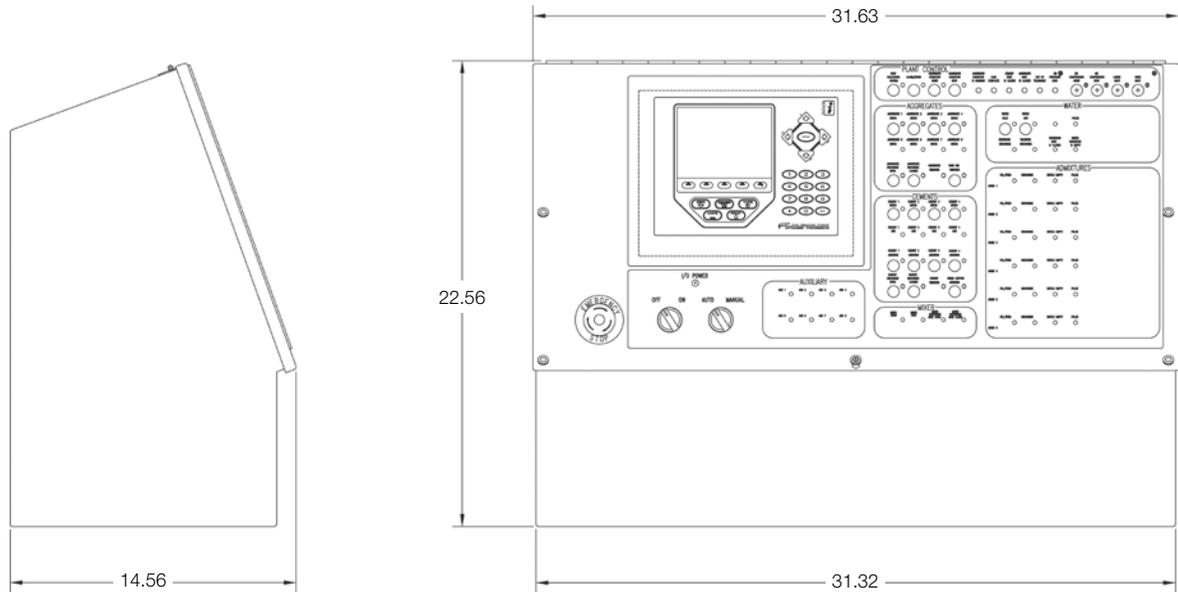





# Counting Scales

## Table of Contents

<b>Counterpart®</b> .....	<b>204</b>
Configurable Counting Indicator	
<b>DIGI® DC-782 Series</b> .....	<b>206</b>
Portable Counting Scales	
<b>DIGI® DC-788 Series</b> .....	<b>207</b>
Industrial Counting Scales	
<b>DIGI® S-YC Series</b> .....	<b>209</b>
Remote Scale Base Platforms	
<b>A&amp;D® FC-i/Si Series</b> .....	<b>210</b>
High Resolution Counting Scale	
<b>A&amp;D® HC-i Series</b> .....	<b>211</b>
<b>OHAUS® Ranger™ Count 3000</b> .....	<b>212</b>
Industrial Counting Scales	
<b>DIGI® DMC-782 Series</b> .....	<b>213</b>
Portable Coin Counting Scales	

**ESPAÑOL** | Visit [ricelake.com/spanish](http://ricelake.com/spanish)  
to see all RLWS materials  
available in Spanish

The following product names, logos, brands, and other trademarks featured or referred to within this publication are the property of their respective trademark holders.

# Counterpart®

Configurable Counting Indicator

## Specifications

### Power Source:

Input: 100-240 VAC, 47-63 Hz, 5 watts, US power cord  
Output: 9-12V, 1.5 A max.

### Excitation Voltage:

5VDC

### Analog Signal Input Range:

0-4.5 mV/V

### Analog Specifications:

Grad minimum: .3 µV/grad  
Input sensitivity: 1.5 µV/grad recommended  
Zero adjustment range: 0-100% or per region settings  
A/D conversion rate: 7.5, 15, 30 samples per second  
Load cells per scale: 8 x 350 Ω; 16 x 700 Ω  
Scale channels: 1 or 2  
Linearity: +/- 0.017 full scale

### Circuit Protection:

RFI, EMI, ESD protection

### Digital I/O:

Four

### Display:

Viewing Area: 240 x 64 pixels, transmissive VGA Liquid Crystal Display (LCD) with adjustable contrast

### Keyboard:

24 buttons, full keypad-alpha numeric

### Resolution:

Weight display resolution: up to 100,000 graduations  
Counting resolution: 1/1,000,000

### Communications and Setpoint:

Two RS-232 ports support up to 115,200 bps  
20 mA  
Ethernet port  
Setpoint output

### Status Annunciators:

PCS, motion, low battery, insuff, recomp, scale number, gross, net, zero

### Units of Measure:

Pounds, kilograms, grams, ounces

### Prints:

Standard EPL label format; format is changeable to work with virtually any printer

### Optional Battery:

Type: Lithium Ion  
Charge time six to eight hours  
Charge cycles: 400-1200  
Estimated runtime: 24-32 hours with one 350 Ω  
load cell base

### Operating Temperature:

10° F to 104° F (0° C to 40° C)

### Operating Humidity:

85%

### Physical Dimensions:

Indicator Only: 12.25 x 6.25 x 4.0 in  
(311.15 x 158.75 x 101.6 mm)

### Warranty:

Two-year limited warranty

### Approvals:

NTEP CC 12-110  
CE  
UL listed  
Measurement Canada



## APPROVALS



Measurement  
Canada  
Approved

## Standard Features

- AC operated (battery operation is option)
- LCD graphic transmissive display for indoor viewing or transmissive graphic LCD display
- Lb/kg/oz/g weight display conversion
- Single or dual channel models with serial scale input
- Mix and match platforms with console
- Four setpoint outputs for counting
- Two RS-232 ports for connecting peripherals
- Ethernet TCP/IP
- Scanner input (RS-232)
- PC software utility (Revolution) for setup
- 150 item memory

## Options

- Battery
- USB for USB keyboard
- Weigh Vault for Counterpart

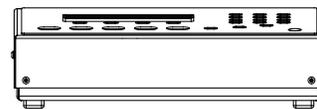
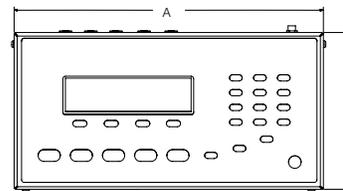

## DIMENSIONS

	A	B	C
A	12.3 in (312.4 mm)		C
B	6.17 in (156.7 mm)		



DIGI® Scale Base



Shown with BenchMark®  
Scale Base and Bracket

## Part Number/Price

PART #	MODEL #	CAPACITY	PLATTER DIMENSIONS	EST. SHIP WEIGHT	PRICE
118788	CP single channel indicator	Console only	n/a	10 lb (4.5 kg)	\$995.00
120770	CP dual channel indicator	Console only	n/a	10 lb (4.5 kg)	1,025.00
132429	CP single channel, EU power cord	Console only	n/a	10 lb (4.5 kg)	995.00
132431	CP dual channel, EU power cord	Console only	n/a	10 lb (4.5 kg)	1,025.00
<b>Single Channel with DIGI® S-YC base system and bracket</b>					
155089	CP-1	1 x 0.0001 lb (500 g x 0.05 g)	7.9 x 5.6 in (200 x 142 mm)	35 lb (15.9 kg)	1,375.00
155090	CP-2	2 x 0.0002 lb (1 x 0.0001 kg)	9.6 x 6.9 in (244 x 175 mm)	35 lb (15.9 kg)	1,375.00
155092	CP-5	5 x 0.0005 lb (2.5 x 0.0002 kg)	13.4 x 11 in (341 x 284 mm)	35 lb (15.9 kg)	1,325.00
155094	CP-10	10 x 0.001 lb (5 x 0.0005 kg)	13.4 x 11 in (341 x 284 mm)	35 lb (15.9 kg)	1,325.00
155097	CP-25	25 x 0.002 lb (10 x 0.001 kg)	13.4 x 11 in (341 x 284 mm)	35 lb (15.9 kg)	1,325.00
155101	CP-50	50 x 0.005 lb (25 x 0.002 kg)	13.4 x 11 in (341 x 284 mm)	35 lb (15.9 kg)	1,325.00
<b>Dual Channel with DIGI S-YC base system and bracket (second channel available for use with other bases)</b>					
155115	CP-1	1 x 0.0001 lb (500 g x 0.05 g)	7.9 x 5.6 in (200 x 142 mm)	35 lb (15.9 kg)	1,425.00
155116	CP-2	2 x 0.0002 lb (1 x 0.0001 kg)	9.6 x 6.9 in (244 x 175 mm)	35 lb (15.9 kg)	1,425.00
155117	CP-5	5 x 0.0005 lb (2.5 x 0.0002 kg)	13.4 x 11 in (341 x 284 mm)	35 lb (15.9 kg)	1,395.00
155118	CP-10	10 x 0.001 lb (5 x 0.0005 kg)	13.4 x 11 in (341 x 284 mm)	35 lb (15.9 kg)	1,395.00
155119	CP-25	25 x 0.002 lb (10 x 0.001 kg)	13.4 x 11 in (341 x 284 mm)	35 lb (15.9 kg)	1,395.00
155120	CP-50	50 x 0.005 lb (25 x 0.002 kg)	13.4 x 11 in (341 x 284 mm)	35 lb (15.9 kg)	1,395.00
<b>Dual Channel with BenchMark™ base system and bracket (second channel available for use with other bases)</b>					
125113	CP-50BM	50 x 0.01 lb (20 x 0.002 kg)	12 x 18 in (304.8 x 457.2 mm)	45 lb (20.4 kg)	1,450.00
125116	CP-100BM	100 x 0.02 lb (50 x 0.005 kg)	12 x 18 in (304.8 x 457.2 mm)	45 lb (20.4 kg)	1,450.00

## Options/Accessories

PART #	DESCRIPTION	PRICE
124692	Rechargeable lithium-ion battery option	\$295.00
53828	14-Pin Y-cable, connects two remote DIGI bases	85.00
32375	Connector, 14-Pin Amphenol load cell (can be soldered to home run cable)	20.00
125062	Ethernet quick access coverplate for Counterpart®	20.00
130537	USB for Counterpart, keyboard only	150.00
125079	Quick access 9-Pin cover plate	10.00
120767	Quick access 14-Pin Amphenol cover plate	15.00
125495	Wireless LAN card WIFI 802.11 A/B, optional kit	570.00
125546	WeighVault™ for Counterpart	200.00
77925	Revolution®, PC software utility for setup	35.00
118677	Operators manual (129606 Spanish operator's manual)	25.00
121459	Front mount bracket for Benchmark™ scales, S-XL bases	50.00
154700	Front mount bracket, for S-YC scales	50.00
121474	Software download cable	35.00
121501	Stand, angled free standing for table top	80.00
128063	Power supply, 12V (power cord sold separately)	55.00
15438	Power cord	17.75
<b>Printers/Cables:</b>		
132423	DT2 printer, 2 in direct thermal, 203 dpi, real time clock 110/240 VAC	345.00
65617	Direct thermal label, 2.25 in W x 4.5 in long, 1 in core, 5 in OD perfed	14.60
41276	Cable DB9M to blunt end RS-232 cable for DT2	65.00
78860	Ethernet cross cable for direct connection to WeighVault™	35.00
<b>Scanner:</b>		
121495	Kit, QD2100 RS-232 scanner, cable stand and DB9 quick connect cable (supplies power to scanner, reduces battery life)	335.00

# DIGI® DC-782 Series

Portable Counting Scales

## Specifications

### Internal Resolution:

1/500,000

### Weight Display Resolution:

1/7500 (1/6000)

### Display:

Liquid Crystal Display (LCD) with backlight

Weight: Five-digit

Unit Weight: Five-digit

Quantity: Six-digit

### Power Source:

120 VAC power supply (US power cord)

### Number of Scale Channel:

One local scale

### Memory Items:

25

### Optional Battery:

Charge time: 12-14 hours

Estimated runtime: 300 hours (no backlight)

### Operating Temperature:

14°F to 104°F (-10°C to 40°C)

### Dimensions:

Overall: 335.7 W x 349.7 m D x 123.5 mm H (13 in W x 13 in L x 5 in H)

### Estimated Shipping Weight:

5 kg

### Platter Size:

300 x 225 mm (12 x 8.9 in)

### Warranty:

Two-year limited warranty



## Standard Features

- Liquid Crystal Display (LCD) with yellow backlight
- 10 preset keys for product ID
- 25 item memory
- Internal resolution of 1/500,000
- Buzzer - low, ok, high

## Part Number/Price

PART #	DESCRIPTION	CAPACITY	EST. SHIP WEIGHT	PRICE
108248	DC-782	6 lb x 0.001 lb	11 lb (5 kg)	\$540.00
108249	DC-782	15 lb x 0.002 lb	11 lb (5 kg)	540.00
108250	DC-782	30 lb x 0.005 lb	11 lb (5 kg)	540.00
108251	DC-782	60 lb x 0.01 lb	11 lb (5 kg)	540.00

Consult factory for kg unit models.

## Options/Accessories

PART #	DESCRIPTION	PRICE
108516*	Rechargeable battery	\$35.00
73382	AC adapter 110VAC	60.00
108518	AC adapter 110 - 230VAC (prior to May 2011 production units)	45.00
109429	Manual	25.00
73296	Carrying case	200.00

\* Batteries not included

# DIGI® DC-788 Series

## Industrial Counting Scales

### Specifications

---

**Internal Resolution:**

1/1,000,000

**Weight Display Resolution:**

1/5,000 NTEP, other selections capacity dependent

**Display:**

Liquid Crystal Display (LCD)

Weight: Five-digit

Unit weight: Five-digit

Quantity: Seven-digit

Tare: Five-digit

**Power Source Consumption:**

AC: 115, 60 Hz

Optional battery: 6V, 5.0Ah

**Printer Compatibility:**

DT4

Epson® TM-U220 Tape

STAR® SP512 Tape

Epson TM-U295 Ticket

**Zero Adjust Range:**

±127% full scale

**Input Sensitivity:**

0.4 mV/V to 4 mV/V

**Load Cell Excitation:**

5VDC

**Number of Scale Channels:**

One remote scale, one 350Ω load cell

**Memory Items:**

100 items

**Load Cell Input Connector:**

Amphenol 14-Pin

**Computer Interface:**

RS-232 DB-9M connection

**Battery Operation:**

24 hours of continuous usage

**Charge Time:**

8-10 hours

**Operating Temperature:**

14°F to 104°F (-10°C to 40°C)

**Dimensions:**

Overall: 14 in W x 13.75 in D x 4.5 in H (354 mm W x 349 mm D x 115 mm H)

**Estimated Shipping Weight:**

15 lb (7 kg)

**Warranty:**

Two-year limited warranty

**Approvals:**

NTEP CC 07-015 (10 lb - 100 lb) Class III for weigh mode only

10 lb to 100 lb-scales only



### Standard Features

---

- Internal resolution of 1/1,000,000
- Auto recomputing function
- Negative sampling and counting (count out of a full container)
- Vivid, bright green Liquid Crystal Display (LCD)
- Simultaneously weight display, unit weight, tare and quantity
- Net/gross weight display
- Lb/kg weight display conversion
- Full-duplex RS-232 output to PC or printer
- AC or rechargeable battery operation (battery optional)
- Choice of unit weight per thousand or average piece weight
- Remote scale capability
- 100 product look up registers
- NTEP for non-counting applications

# DIGI® DC-788 Series

Industrial Counting Scales

## Part Number/Price

PART #	DESCRIPTION	WEIGHING RESOLUTION	PLATTER	EST. SHIP WEIGHT	PRICE
*88928	DC-788, 2 lb (1 kg)	0.0002 lb (0.0001 kg)	7 in x 10 in (178 x 254 mm)	15 lb (7 kg)	\$850.00
88929	DC-788, 10 lb (5 kg)	0.002 lb (0.001 kg)	10 in x 13 in (254 x 330 mm)	15 lb (7 kg)	850.00
88930	DC-788, 25 lb (10 kg)	0.005 lb (0.002 kg)	10 in x 13 in (254 x 330 mm)	15 lb (7 kg)	850.00
88931	DC-788, 50 lb (25 kg)	0.01 lb (0.005 kg)	10 in x 13 in (254 x 330 mm)	15 lb (7 kg)	850.00
88932	DC-788, 100 lb (50 kg)	0.02 lb (0.01 kg)	10 in x 13 in (254 x 330 mm)	15 lb (7 kg)	850.00

### Scale Bases

PART #	DESCRIPTION	PLATTER DIMENSIONS	OVERALL DIMENSIONS	EST. SHIP WEIGHT	PRICE
154835	500 g (1 lb)	7.9 x 5.6 in (201 x 143 mm)	13.4 x 11.1 x 3.5 in (341 x 284 x 90 mm)	7.7 lb (3.5 kg)	\$600.00
154836	1 kg (2 lb)	9.6 x 6.9 in (244 x 177 mm)	13.4 x 11.1 x 3.5 in (341 x 284 x 90 mm)	7.7 lb (3.5 kg)	600.00
154838	2.5 kg (5 lb)	13.4 x 11.1 in (341 x 284 mm)	13.4 x 11.1 x 4.75 in (341 x 284 x 120 mm)	11 lb (5 kg)	545.00
154839	5 kg (10 lb)	13.4 x 11.1 in (341 x 284 mm)	13.4 x 11.1 x 4.75 in (341 x 284 x 120 mm)	11 lb (5 kg)	545.00
154840	10 kg (20 lb)	13.4 x 11.1 in (341 x 284 mm)	13.4 x 11.1 x 4.75 in (341 x 284 x 120 mm)	11 lb (5 kg)	545.00
154841	25 kg (50 lb)	13.4 x 11.1 in (341 x 284 mm)	13.4 x 11.1 x 4.75 in (341 x 284 x 120 mm)	11 lb (5 kg)	545.00

\*Non NTEP

## Options/Accessories

PART #	DESCRIPTION	PRICE
88933	Rechargeable battery—lead acid type	\$78.00
73386	Anti-static sample tray	25.00
32375	14-Pin load cell connector, Amphenol (remote base, non-DIGI)	20.00
35319	14-Pin load cell connector with 20 ft cable	70.00
91685	Additional operating and service manual	25.00
70056	9-Pin printer cable to DT4, G500	35.00
72440	9-Pin printer cable to Epson TM-U220/TM-U295 SP512	65.00
66535	9-Pin cable to PC, null modem cable	45.00
91214	AC adapter	35.00
<b>Printers</b>		
132424	DT-4, 4 in Direct Thermal	395.00
132425	G500, 4 in Thermal Transfer	585.00
110355	Label 4.0 x 2.5 in with perf, Direct Thermal	20.10

# DIGI® S-YC Series

Remote Scale Base Platforms

## Specifications

**Output Impedance:**

350 +/-5 ohms

**Insulation Resistance:**

>500 Mohm

**Rated Output:**

1.0016 mV/V

**Color Code:**

Green .....+ Output

Yellow .....- Output

Black..... Shield

White .....- Input

Red .....+ Input

**Load Cell Type:**

K-Type DIGI cell

**Load Cell Cable Length**

118 in (3 m)

**Operating Temperature:**

14°F to 104°F (-10°C to 40°C)

**Warranty**

Two-year limited warranty



## Standard Features

- Stainless steel platter
- ABS injection-molded plastic base
- Single-point strain gauge load cell
- Adjustable legs
- Leveling bubble
- 14-Pin connector on three meter cable

## Part Number/Price

PART #	DESCRIPTION	PLATTER DIMENSIONS	OVERALL DIMENSIONS	EST. SHIP WEIGHT	PRICE
154835	500 g (1 lb)	7.9 x 5.6 in (201 x 143 mm)	13.4 x 11.1 x 3.5 in (341 x 284 x 90 mm)	7.7 lb (3.5 kg)	\$600.00
154836	1 kg (2 lb)	9.6 x 6.9 in (244 x 177 mm)	13.4 x 11.1 x 3.5 in (341 x 284 x 90 mm)	7.7 lb (3.5 kg)	600.00
154838	2.5 kg (5 lb)	13.4 x 11.1 in (341 x 284 mm)	13.4 x 11.1 x 4.75 in (341 x 284 x 120 mm)	11 lb (5 kg)	545.00
154839	5 kg (10 lb)	13.4 x 11.1 in (341 x 284 mm)	13.4 x 11.1 x 4.75 in (341 x 284 x 120 mm)	11 lb (5 kg)	545.00
154840	10 kg (20 lb)	13.4 x 11.1 in (341 x 284 mm)	13.4 x 11.1 x 4.75 in (341 x 284 x 120 mm)	11 lb (5 kg)	545.00
154841	25 kg (50 lb)	13.4 x 11.1 in (341 x 284 mm)	13.4 x 11.1 x 4.75 in (341 x 284 x 120 mm)	11 lb (5 kg)	545.00

# A&D® FC-i/Si Series

High Resolution Counting Scale

## Specifications

### Internal Resolution:

Si Series: 1/5,000,000

FC-i Series: 1/1,000,000

### Display:

Vacuum Fluorescent Display (VFD)

Seven segment

### Power Source (included):

110VAC 50/60 Hz AC adapter

230VAC 50/60 Hz AC adapter

### Minimum Sample Unit Weight:

500si - 0.0001 g, 5000si - 0.001 g

500si - 0.0005 g, 1000i - 0.001 g

2000i - 0.002 g, 5000i - 0.005 g

10Ki - 0.01 g, 20Ki - 0.02 g

50Ki - 0.05 g

### Memory Items:

500 ID - Six digit ID, unit weight, tare weight, comparator limits, accumulator and 12-digit ID name

### Weight Sensor:

Si - Super Hybrid Sensor (SHS)

FC-i - Strain gauge load cell

### Operating Temperature:

Si: 41°F to 104°F (5°C to 40°C)

FC-i: 14°F to 104°F (-10°C to +40°C)

### Dimensions:

Overall: 13.0 L x 18.2 W x 4.6 in H

(330 L x 462 W x 117 mm H)

### Warranty:

Two-year limited warranty



## Standard Features

- 500 ID memory storage
- LED (Light Emitting Diode keypad) prompting for intuitive operator use
- Automatic Counting Accuracy Improvement (ACAI)
- Display function - Hi/OK/Lo
- Rugged aluminum die-cast frame with splash-proof display and keyboard

## Optional Features

- Remote scale

## Part Number/Price

PART #	MODEL #	DESCRIPTION	RESOLUTION	PAN SIZE	PRICE
108351	FC-500Si	1 lb x .00005 lb/500 g x .02 g	0.0001 g	5 in x 5 in	\$1,695.00
108352	FC-5000Si	10 lb x .0005 lb/5 kg x .2 g	0.001 g	6.5 in x 6.5 in	1,695.00
108353	FC-1000i	2 lb x 0.0002 lb/1 kg x .1 g	0.001 g	8 in x 6 in	1,245.00
108354	FC-2000i	5 lb x 0.0005 lb/ 2 kg x .2 g	0.002 g	11.8 in x 11 in	1,245.00
108355	FC-5000i	10 lb x .001 lb/5 kg x .5 g	0.005 g	11.8 in x 11 in	1,245.00
108356	FC-10Ki	20 lb x .002 lb/10 kg x 1 g	0.01 g	11.8 in x 11 in	1,245.00
108357	FC-20Ki	50 lb x .005 lb/20 kg x 2 g	0.02 g	11.8 in x 11 in	1,245.00
108358	FC-50Ki	100 lb x .01 lb/50 kg x 5 g	0.05 g	11.8 in 11 in	1,245.00

## Options/Accessories

PART #	MODEL #	DESCRIPTION	PRICE
108360	FC-05i	Remote scale connection	\$138.00
97630	TB-110C	AC adapter 120V - standard with unit	40.00
97631	TB-123	AC adapter 240V	50.00



# A&D® HC-i Series

## Specifications

### Internal Resolution:

HC-3Ki, 6Ki, 30Ki: 1/600,000  
 HC-15Ki: 1/750,000

### Display:

Seven segment Liquid Crystal Display (LCD)  
 Character height: pcs 18.6 mm  
 Unit weight: 11.4 mm

### Power Source (included):

AC adapter or SLA battery option  
 Operating time approximately 80 hours  
 without interface

### Memory Items:

99 weight registers

### Weight Sensor:

Load cell

### Operating Temperature:

14°F to 104°F (-10°C to 40°C)

### Dimensions:

Overall: 12.4 L x 13 W x 5 in H  
 (315 L x 331 W x 126 mm H)

### Warranty:

Two-year limited warranty



## Standard Features

- Sealed removable display unit
- Automatic Counting Accuracy Improvement (ACAI)
- Audible Weighing Assist beeping function (AWA)
- Computer display function - Hi/OK/Lo
- Accumulation function
- Full digital calibration function
- Auto power-off function

## Optional Features

- Rechargeable battery
- RS-232C

## Part Number/Price

PART #	MODEL #	DESCRIPTION	PAN SIZE	PRICE
112837	HC-3Ki	6 lb x 0.001 lb (3 kg x 0.0005 kg)	11.8 in x 8.3 in (300 x 211 mm)	\$670.00
112838	HC-6Ki	15 lb x 0.002 lb (6 kg x 0.001 kg)	11.8 in x 8.3 in (300 x 211 mm)	670.00
112839	HC15Ki	30 lb x 0.005 lb (15 kg x 0.002 kg)	11.8 in x 8.3 in (300 x 211 mm)	670.00
112840	HC-30Ki	60 lb x 0.01 lb (30 kg x 0.005 kg)	11.8 in x 8.3 in (300 x 211 mm)	670.00

## Options/Accessories

PART #	MODEL #	DESCRIPTION	PRICE
112841	HC-03i	RS-232C for HC-i	\$72.00
112842	HC-06i	Rechargeable battery pack	40.00
112843	TB-163C	AC adapter, 120V, standard with unit	39.00

# OHAUS® Ranger™ Count 3000

Industrial Counting Scales

## Specifications

### Internal Resolution:

1/500,000

### Display:

Seven segment 1/30,000, six-digit

### Power Source (included):

100-240 VAC, 50-60 Hz internal universal power supply

### Optional Battery:

Lead acid, 210 hours, 12 hours recharge

### Number or Scale Channels:

Optional second channel

### Memory Items:

(30)12 digit part number, average piece weights, check counting or checkweighing parameters, tare weights, accumulated weights or counts

### Operating Temperature:

14°F to 104°F (-10°C to 40°C)

### Dimensions:

Overall: 12.2 L x 12.9 W x 4.6 in H  
(311 L x 327 W x 117 mm H)

### Platter Size

11.8 x 8.9 in (300 x 225 mm)

### Approvals:

NTEP 3000e  
CAN/CSA-C22.2 No. 61010-1-04  
UL Std. No. 61010-1 (2nd edition)

### Warranty:

One-year limited warranty



## Standard Features

- Weigh in kilograms, pounds, grams or ounces
- 30-item data storage
- Three backlit LCD display windows
- RS-232 output
- Quick stabilization

## Optional Features

- Ethernet
- Second platform

## Part Number/Price

PART #	MODEL #	DESCRIPTION	EST. SHIPPING WEIGHT	PRICE
157273	RC31P1502	3 lb x 0.0001 lb (1.5 kg x 0.00005 kg) 48 oz x 0.002 oz (1500 g x 0.05 g)	12 lb (5.45 kg)	\$620.00
157275	RC31P3	6 lb x 0.0002 lb (3 kg x 0.0001 kg) 96 oz x 0.05 oz (3000 g x 0.1 g)	12 lb (5.45 kg)	620.00
157277	RC31P6	15 lb x 0.0005 lb (6 kg x 0.0002 kg) 240 oz x 0.01 oz (6000 g x 0.2 g)	12 lb (5.45 kg)	620.00
157278	R31P15	30 lb x 0.001 lb (15 kg x 0.0005 kg) 480 oz x 0.02 oz (15000 g x 0.5 g)	12 lb (5.45 kg)	620.00
157279	R31P30	60 lb x 2 0.002 lb (30 kg x 0.001 kg) 960 oz x 0.05 oz (30000 g x 1 g)	12 lb (5.45 kg)	620.00

## Options/Accessories

PART #	DESCRIPTION	PRICE
157280	Remote second scale option kit	\$100.00
154638	Ethernet kit	104.00

# DIGI® DMC-782 Series

Portable Coin Counting Scales

## Specifications

**Internal Resolution:**

1/500,000

**Weight Display Resolution:**

1/7500 or 1/6000

**Display:**

Liquid Crystal Display (LCD) with backlight

Weight: Five-digit

Denomination: Five-digit

Quantity/Amount: Six-digit

**Power Source:**

120 AC power supply or optional

Rechargeable Battery

**Optional Battery:**

Charge Time: 12-14 hours

Battery life: 300 hours (no backlight)

**Number of Scale Channel:**

One local scale

**Memory Items:**

18

**Operating Temperature:**

14°F to 104°F (-10°C to 40°C)

**Dimensions:**

13.2 in W x 13.7 in L x 4.8 in H

(335.7 mm W x 349.7 mm D x 123.5 mm H)

**Platter Size:**

12 in W x 8.9 in L

(300 mm x 225 mm)

**Estimated Shipping Weight:**

11 lb (5 kg)

**Warranty:**

Two-year limited warranty



## Standard Features

- Liquid Crystal Display (LCD) with yellow backlight
- 18 preset keys for product ID
- Programmable denomination unit weight and tare weight
- Internal resolution of 1/500,000
- Accumulation
- Toggle display: count and money value
- Total amount calculation utilizing reverse counting

## Options

- Rechargeable battery
- Carrying case

## Part Number/Price

PART #	DESCRIPTION	CAPACITY	EST. SHIP WEIGHT	PRICE
111317	DMC-782	6 lb x 0.001 lb	11 lb (5 kg)	\$590.00
111318	DMC-782	15 lb x 0.002 lb	11 lb (5 kg)	590.00
111319	DMC-782	60 lb x 0.01 lb	11 lb (5 kg)	590.00

Consult factory for kg unit models.

## Options/Accessories

PART #	DESCRIPTION	PRICE
15438	Power Cord	\$17.75
111781	Manual	25.00
108516*	Rechargeable battery	35.00
73296	Carrying case, hard shell with locking latches	200.00

\* Battery not included



# Crane Scales

## Table of Contents

<b>MSI-3460 Challenger 3</b> .....	<b>216</b>
<b>MSI-4260 Port-A-Weigh</b> .....	<b>218</b>
<b>MSI-4300 Port-A-Weigh Plus</b> .....	<b>220</b>
<b>MSI-9300 Port-A-Weigh Plus CellScale™ RF</b> .....	<b>222</b>
<b>MSI-9300HT Hi-Torque Port-A-Weigh Plus CellScale™ RF</b> .....	<b>224</b>
<b>MSI-6260CS Trans-Weigh CellScale™ RF</b> .....	<b>226</b>
<b>MSI-7300 Dyna-Link 2</b> .....	<b>228</b>
Digital Tension Dynamometer	
<b>MSI-8000</b> .....	<b>231</b>
RF Remote Display	
<b>MSI-8000HD</b> .....	<b>232</b>
Indicator/Remote Display	
<b>TranSend™ Wireless Load Cell Interface System</b> .....	<b>233</b>
<b>MSI-9850 CellScale™ RF Digital Indicator</b> .....	<b>235</b>
<b>MSI-9750A CellScale™ RF Portable Indicator</b> .....	<b>237</b>
<b>MSI-9000 CellScale™</b> .....	<b>238</b>
<b>MSI-9020 CellScale™ RF CellModem</b> .....	<b>240</b>
<b>MSI Scoreboards Wireless RF</b> .....	<b>241</b>
Remote Displays	
<b>Shackle Dimensions</b> .....	<b>242</b>
<b>Intercomp CS™ 200</b> .....	<b>243</b>
<b>Intercomp CS™ 750</b> .....	<b>244</b>
<b>Intercomp CS™ 1500</b> .....	<b>245</b>
<b>Intercomp CS™ 3000-RFX</b> .....	<b>247</b>
<b>Intercomp TL 8500</b> .....	<b>249</b>

**ESPAÑOL** | Visit [ricelake.com/spanish](http://ricelake.com/spanish)  
to see all RLWS materials  
available in Spanish

The following product names, logos, brands, and other trademarks featured or referred to within this publication are the property of their respective trademark holders.

# MSI-3460 Challenger 3

## Specifications

**Accuracy:**

± (0.1% +1 d) of applied load

**Resolution:**

2000 to 3750 d standard (Up to 10,000 d available)

**Enclosure:**

NEMA 4, IP65, powder coated cast aluminum

**Lifting Eye & Hook:**

Crosby® or equivalent with 360° non-bearing swivel hook

**Design Overload:**

200% Safe / 500% Ultimate

**Functions:**

Power: Turns unit ON or OFF Zero: Zeros applied load up to 100% of capacity (limited range in NTEP/OIML configurations) Tare: Tares applied load and displays weight in Net mode User: Programmable as TEST, UNITS, NET/GROSS, TOTAL, PEAK HOLD & SETPOINTS

**Display:**

5-digit, 1.5 in (38 mm) LED with programmable brightness control

**Displayable Units:**

Pounds or kilogram selectable

**Annunciators:**

COZ, Net, Gross, Total, Peak, Low Battery, lb/kg, Motion, Setpoints, ACK IN, ACK OUT, RF

**Power:**

6 Volt rechargeable battery. 115/230VAC battery charger is included

**Operating Time:**

Up to 80 hours between charging with typical use. Less with optional RF Model

**Operating Temperature:**

-40° to 104°F (-40° to 40°C)

**Auto-Off Mode:**

Select for 15, 30, 45, 60 minutes or Off

**Auto Sleep Mode:**

Power down during non-use and power up with weight change or any key press

**Service Counters:**

Counts number of lifts over percentage of capacity and lifts over capacity

**Calibration:**

Digital

**Filtering:**

OFF, L0, HI-1, HI-2 selectable

**Warranty:**

One-year limited

**Approvals:**

NTEP CC 86-021



## APPROVALS



## Standard Features

- Crane unit with five-digit, 1.5 in (38 mm) LED display
- Top lifting eye or shackle and bottom swivel hook
- Lb / kg switch selectable
- Six Volt rechargeable battery and universal 115/230VAC, 50/60 Hz battery charger (NA Plug Standard)

## Additional Options

### (Contact MSI for application consultation)

- RF Remote Controller (control for On/Off, Zero, Tare and other functions)
- RF modem install for connectivity to MSI-8000 or MSI-8000HD RF Remote Display
- RF Scoreboard
- NTEP Certified (250-10,000 lb capacities)
- Universal direct power supply (115/230VAC)

# MSI-3460 Challenger 3

## Part Number/Price

PART #	MSI PART #	DESCRIPTION	CAPACITY	RESOLUTION	EST. SHIP WEIGHT	PRICE
139102	502887-0001	MSI-3460 250/500 lb cap F/A	250 lb / 125 kg 500 lb / 250 kg	0.1 lb / 0.05 kg 0.2 lb / 0.1 kg	22 lb / 10 kg	\$1,750.00
139103	502887-0002	MSI-3460 1000/2000 lb cap F/A	1,000 lb / 500 kg 2,000 lb / 1,000 kg	0.5 lb / 0.2 kg 1 lb / 0.5 kg	22 lb / 10 kg	1,850.00
139104	502887-0003	MSI-3460 5000/10,000 lb cap F/A	5,000 lb / 2,500 kg 10,000 lb / 5,000 kg	2 lb / 1 kg 5 lb / 2 kg	39 lb / 18 kg	2,295.00
139105	502887-0004	MSI-3460 15,000 lb cap F/A	15,000 lb / 7,000 kg	5 lb / 2 kg	67 lb / 30 kg	3,195.00
139106	502887-0005	MSI-3460 250/500 lb cap F/A with RF remote controller	250 lb / 125 kg 500 lb / 250 kg	0.1 lb / 0.05 kg 0.2 lb / 0.1 kg	22 lb / 10 kg	2,035.00
139107	502887-0006	MSI-3460 1000/2000 lb cap F/A with RF remote controller	1,000 lb / 500 kg 2,000 lb / 1,000 kg	0.5 lb / 0.2 kg 1 lb / 0.5 kg	22 lb / 10 kg	2,135.00
139108	502887-0007	MSI-3460 5000/10,000 lb cap F/A With RF remote controller	5,000 lb / 2,500 kg 10,000 lb / 5,000 kg	2 lb / 1 kg 5 lb / 2 kg	39 lb / 18 kg	2,580.00
139109	502887-0008	MSI-3460 15,000 lb cap F/A with RF remote controller	15,000 lb / 7,000 kg	5 lb / 2 kg	67 lb / 30 kg	3,480.00
139110	502887-0009	MSI-3460 250/500 lb cap F/A with RF modem install for connectivity to model MSI-8000	250 lb / 125 kg 500 lb / 250 kg	0.1 lb / 0.05 kg 0.2 lb / 0.1 kg	22 lb / 10 kg	1,925.00
139111	502887-0010	MSI-3460 1000/2000 lb cap F/A with RF modem install for connectivity to model MSI-8000	1,000 lb / 500 kg 2,000 lb / 1,000 kg	0.5 lb / 0.2 kg 1 lb / 0.5 kg	22 lb / 10 kg	2,025.00
139112	502887-0011	MSI-3460 5000/10,000 lb cap F/A with RF modem install for connectivity to Model MSI-8000	5,000 lb / 2,500 kg 10,000 lb / 5,000 kg	2 lb / 1 kg 5 lb / 2 kg	39 lb / 18 kg	2,470.00
139113	502887-0012	MSI-3460 15,000 lb cap F/A with RF modem install for connectivity to model MSI-8000	15,000 lb / 7,000 kg	5 lb / 2 kg	67 lb / 30 kg	3,370.00
139381	503208-0001	MSI-8000 RF Remote Display (requires MSI-3460 equipped with RF modem)	N/A	N/A	5 lb / 2.25 kg	1,115.00

## Options/Accessories

PART #	MSI PART #	DESCRIPTION	EST. SHIP WEIGHT	PRICE
140049	C00502-0001	Battery assembly, 6 Volt rechargeable	3 lb / 1.4 kg	\$115.00
139152	502956-0001	Universal 115/230VAC, 50/60 Hz battery charger (NA Plug)	5 lb / 2.25 kg	150.00
139153	502956-0002	Battery charger 115/230 VAC, 50/60 Hz (EC Plug)	5 lb / 2.25 kg	150.00
139386	503239-0001	Spare RF remote controller	1 lb / 0.45 kg	97.00
149549	503486-0001	Universal 115/230VAC 50/60 Hz (NA Plug Standard) battery charger for MSI-8000 Remote Display	3 lb / 1.4 kg	120.00
162899	N/A	Red LED, 4 in (101 mm) six-digit display	21 lb / 10 kg	2,195.00
162897	N/A	Red LED, 6 in (152 mm) six-digit display	37 lb / 17 kg	2,650.00

## MSI-4260 Port-A-Weigh

### Specifications

**Accuracy:**

± (0.1% +1 d) of applied load

**Resolution:**

3000 to 5000 d standard (Up to 10,000 d available)

**Enclosure:**

NEMA 4, IP66 marine grade 356 alloy anodized cast aluminum

**Lifting Eye, Shackle & Hook:**

Crosby® or equal with 360° thrust-bearing swivel hook

**Design Overload:**

200% Safe / 500% Ultimate (except where noted)

**Functions:**

Power: Turns Unit ON or OFF, Zero: Zeros applied load up to 100% of capacity (limited range in NTEP configuration),

Tare: Tares applied load and displays weight in Net mode, F1: Programmable as TEST, UNITS, NET/GROSS, TOTAL & PEAK HOLD

**Display:**

Five digit, 1.2 in (30 mm) LED with programmable brightness control

**Displayable Units:**

Pounds or kilograms selectable

**Annunciators:**

COZ, Net, Gross, Total, Peak, Low Battery, lb/kg, Motion, Setpoints

**Power:**

12 Volt rechargeable battery. 115/230VAC battery charger is included

**Operating Time:**

Up to 200 hours between charging with typical use. Less with optional RF Modem Link

**Operating Temperature:**

-4°F to 140°F (-20°C to 60°C)

**Auto-Off Mode:**

Select for 15, 30, 45 minutes, 1 hour or Off

**Auto Sleep Mode:**

Power down during non-use and power up with weight change or any key press

**Service Counters:**

Counts number of lifts over percentage of capacity and lifts over capacity

**Calibration:**

Digital

**Filtering:**

OFF, LO, HI-1, HI-2 selectable

**Warranty:**

One-year limited



### Standard Features

- Crane unit with five-digit, 1.2 in (30 mm) LED display
- Top lifting eye or shackle, bottom thrust bearing swivel hook
- 12 Volt rechargeable battery and universal 115/230VAC, 50/60 Hz battery charger (NA Plug Standard)

### Additional Options

(Contact MSI for application consultation)

- RF Remote Controller (Control for On/Off, Zero, Tare and other functions)
- RF Modem Install for connectivity to MSI-8000 or MSI-8000HD RF remote display
- NTEP Certified configuration
- Anti-heat shielding for high temperature applications
- Substitute bottom swivel hook with shackle
- Oversized top lifting eye or shackle
- Oversized bottom hook
- Universal direct power supply; 85-265 VAC, 47-440 Hz / 130-300VDC
- Low headroom top adapter



# MSI-4260 Port-A-Weigh

## Part Number/Price

PART #	MSI PART #	DESCRIPTION	CAPACITY	RESOLUTION	EST. SHIP WEIGHT	PRICE
139460	503413-0001	MSI-4260B 500 lb F/A	500 lb / 250 kg	0.2 lb / 0.1 kg	53 lb / 24 kg	\$3,770.00
139461	503413-0002	MSI-4260B 2,000 lb F/A	2,000 lb / 1,000 kg	1.0 lb / 0.5 kg	53 lb / 24 kg	3,770.00
139462	503413-0003	MSI-4260B 5,000 lb F/A	5,000 lb / 2,500 kg	1.0 lb / 0.5 kg	62 lb / 28 kg	3,870.00
139463	503413-0004	MSI-4260B 10,000 lb F/A	10,000 lb / 5,000 kg	2.0 lb / 1.0 kg	62 lb / 28 kg	4,075.00
139464	503413-0005	MSI-4260B 20,000 lb F/A	20,000 lb / 10,000 kg	5.0 lb / 2.0 kg	105 lb / 47 kg	5,195.00
139465	503413-0006	MSI-4260B 30,000 lb F/A	30,000 lb / 15,000 kg	10 lb / 5.0 kg	125 lb / 55 kg	5,500.00
139466*	503413-0007	MSI-4260B 50,000 lb F/A	50,000 lb / 25,000 kg	10 lb / 5.0 kg	235 lb / 106 kg	7,850.00
139467**	503413-0008	MSI-4260B 70,000 lb F/A	70,000 lb / 35,000 kg	20 lb / 10 kg	270 lb / 121 kg	9,785.00
139468***	503413-0009	MSI-4260B 100,000 lb F/A	100,000 lb / 50,000 kg	20 lb / 10 kg	420 lb / 189 kg	16,315.00

## Options/Accessories

PART #	MSI PART #	DESCRIPTION	EST. SHIP WEIGHT	PRICE
Consult	N/A	Option kit 4260B WiFi 802.11	N/A	\$595.00
150972	503510-0001	Option kit 4260B RF remote controller	N/A	290.00
150971	503508-0001	Option kit 4260B RF remote display (RF modem install for connectivity with MSI-8000)	N/A	180.00
139381	503208-0001	MSI-8000 RF remote display (requires MSI-4260 equipped with RF modem option 2)	5 lb / 2.25 kg	1,115.00
138007	502221-0002	Universal 115/230 VAC, 50/60 Hz battery charger (UK Plug)	4 lb / 2 kg	255.00
138008	502221-0003	Universal 115/230 VAC, 50/60 Hz battery charger (EC Plug)	4 lb / 2 kg	255.00
139386	503239-0001	Spare RF remote controller	1 lb / 0.45 kg	97.00
159221		Universal Crane Scale Transport Cart	180 lb / 82 kg	920.00
162899	N/A	Red LED, 4 in (101 mm) six-digit display	21 lb / 10 kg	2,195.00
162897	N/A	Red LED, 6 in (152 mm) six-digit display	37 lb / 17 kg	2,650.00
<b>Accessories</b>				
150367	D00559-0004	Battery assembly, 12 V rechargeable	6.6 lb / 3 kg	100.00
138006	502221-0001	Universal 115/230 VAC, 50/60 Hz battery charger (NA Plug standard)	4 lb / 2 kg	255.00
149549	503486-0001	Universal 115/ 230 VAC 50/60 Hz (NA Plug Standard) battery charger for MSI-8000 remote display	3 lb / 1.4 kg	120.00

\* 490% of Kg capacity

\*\* 475% of lb capacity/430% of Kg capacity

\*\*\*450% of Kg capacity

# MSI-4300 Port-A-Weigh Plus

## Specifications

**Accuracy:**

+ (0.1% +1 d) of applied load

**Resolution:**

3000 to 5000 d standard (Up to 10,000 d available)

**Enclosure:**

NEMA 4, IP66, marine grade 356 alloy anodized cast aluminum

**Top Lifting Eye, Shackle & Hook:**

Crosby® or equal with 360° thrust-bearing swivel hook

**Design Overload:**

200% Safe / 500% Ultimate (except where noted)

**Functions:**

POWER, ZERO, NET/GROSS, TARE and programmable TEST/USER

**Display:**

6 digit, 1.6 in (40 mm) LCD (upper) 8 digit, 0.8 in (20 mm) LCD (lower) with adjustable display contrast

**Displayable Units:**

Pounds, Kilograms, Tons, and Metric Tons selectable

**Power:**

12 V rechargeable battery. 115/230VAC battery charger included

**Operating Time:**

300 hours with typical use

**Operating Temperature:**

5°F to 122°F (-15°C to 50°C)

**Filtering:**

OFF, L0, Medium and HI selectable

**Warranty:**

One-year limited



## Standard Features

- Crane unit with six-digit, 1.6 in (40 mm), backlight, liquid crystal display
- Top lifting eye or shackle, bottom thrust bearing swivel hook
- 12 V rechargeable battery and Universal 115/230VAC, 50/60 Hz battery charger (NA Plug Standard)

## Additional Options

### (Contact MSI for application consultation)

- D-cell battery option, provides up to 2,000 hours of operation
- Substitute bottom swivel hook with shackle
- Oversized top-lifting eye or shackle
- Oversized bottom hook
- Universal direct power supply; 85-265VAC, 47-440 Hz / 130-300VDC
- Low headroom top adapter
- RS-232 data output
- Audible setpoint alarm
- NTEP Certified configuration

# MSI-4300 Port-A-Weigh Plus

## Part Number/Price

PART #	MSI PART #	DESCRIPTION	CAPACITY	RESOLUTION	EST. SHIP WEIGHT	PRICE
138825	502666-0013	MSI-4300 500 lb F/A	500 lb / 250 kg	0.2 lb / 0.1 kg	53 lb / 24 kg	\$4,175.00
138826	502666-0014	MSI-4300 2,000 lb F/A	2,000 lb / 1000 kg	1.0 lb / 0.5 kg	53 lb / 24 kg	4,175.00
138827	502666-0015	MSI-4300 5,000 lb F/A	5,000 lb / 2500 kg	1.0 lb / 0.5 kg	62 lb / 28 kg	4,280.00
138828	502666-0016	MSI-4300 10,000 lb F/A	10,000 lb / 5000 kg	2.0 lb / 1.0 kg	62 lb / 28 kg	4,485.00
138069	502235-0032	MSI-4300 20,000 lb F/A	20,000 lb / 10,000 kg	5.0 lb / 2.0 kg	105 lb / 47 kg	5,605.00
138070	502235-0033	MSI-4300 30,000 lb F/A	30,000 lb / 15,000 kg	10 lb / 5.0 kg	125 lb / 55 kg	5,910.00
138071*	502235-0034	MSI-4300 50,000 lb F/A	50,000 lb / 25,000 kg	10 lb / 5.0 kg	235 lb / 106 kg	8,255.00
138072**	502235-0035	MSI-4300 70,000 lb F/A	70,000 lb / 35,000 kg	20 lb / 10 kg	270 lb / 121 kg	10,195.00
138073***	502235-0036	MSI-4300 100,000 lb F/A	100,000 lb / 50,000 kg	20 lb / 10 kg	420 lb / 189 kg	16,720.00

## Options/Accessories

PART #	MSI PART #	DESCRIPTION	EST. SHIP WEIGHT	PRICE
138007	502221-0002	Universal 115/230 VAC, 50/60 Hz battery charger (UK Plug)	4 lb / 2 kg	\$255.00
138008	502221-0003	Universal 115/230 VAC, 50/60 Hz battery charger (EC Plug)	4 lb / 2 kg	255.00
159221		Universal Crane Scale Transport Cart	180 lb / 82 kg	920.00
<b>Accessories</b>				
150367	D00559-0004	Battery assembly, 12 Volt rechargeable	6.6 lb / 3 kg	100.00
138006	502221-0001	Universal 115/230 VAC, 50/60 Hz battery charger (NA Plug Standard)	4 lb / 2 kg	255.00

\* 490% of Kg capacity

\*\* 475% of lb capacity/430% of Kg capacity

\*\*\* 450% of Kg capacity

# MSI-9300 Port-A-Weigh Plus CellScale™ RF

## Specifications

**Accuracy:**

±(0.1% +1 d) of applied load

**Resolution:**

3000 to 5000 d standard (Up to 10,000 d available)

**Enclosure:**

NEMA 4, IP66, marine grade 356 alloy anodized cast aluminum

**Lifting Eye, Shackle & Hook:**

Crosby® or equal with 360° thrust-bearing swivel hook.

**Design Overload:**

200% Safe / 500% Ultimate (except where noted)

**Functions:**

POWER, ZERO, NET/GROSS, TARE and Programmable TEST/USER

**Display:**

Six digit, 1.2 in (30 mm) LED with 14 feature annunciators and programmable brightness control

**Displayable Units:**

Pounds or kilograms selectable

**Power:**

12 V rechargeable battery, 115-230VAC battery charger included

**Operating Time:**

Up to 30 hours between charging with typical use

**Operating Temperature:**

-4°F to 140°F (-20°C to 60°C)

**Calibration:**

Digital via MSI-9750A or MSI-9850 RF indicators or via serial interface with PC terminal program.

**Filtering:**

LO, Medium and HI selectable

**Radio Link:**

FHSS at 2.4 GHz

Radio Effective Range:

Typically 500 ft (150 m) indoor, 1000 ft (300 m) outdoor with standard antennas.

**Approvals:**

NTEP CC 07-007; 5,000 - 70,000 lb (2,500 - 35,000 kg capacities)

**Warranty:**

1 year limited



## APPROVALS



5,000 to 70,000 lb

## Standard Features

- Crane Unit with 2.4 GHz FHSS transceiver
- Six digit, 30 mm (1.2 in.) LED display and annunciators
- Top lifting eye or shackle, and bottom thrust bearing swivel hook
- 12 Volt rechargeable battery and Universal 115/230 VAC, 50/60 Hz battery charger (NA Plug Standard)

## Additional Options

### (Contact MSI for application consultation)

- RF remote crane unit control, includes On/Off, Zero, Tare, Net/Gross, Total and programmable function keys
- Audible alarm
- Anti-heat shielding for high temperature applications
- Substitute bottom swivel hook with shackle
- Low headroom top adapter
- Oversized top lifting eye or shackle
- Oversized bottom hook
- Universal direct power supply; 85-265VAC, 47-440 Hz / 130-300VDC
- Wireless 802.11 b/g Ethernet connectivity
- MSI-9300 Retrofit Kit - conversion kit to upgrade existing MSI-4300 crane scale to 9300 RF unit

(Note: communicates with MSI-9850, 9750A, Remote RF Indicators or MSI RF Scoreboard. Each sold separately)

# MSI-9300 Port-A-Weigh Plus CellScale™ RF

## Part Number/Price

PART #	MSI PART #	DESCRIPTION	CAPACITY	RESOLUTION	EST. SHIP WEIGHT	PRICE
138704	502654-0001	MSI-9300 500 lb F/A	500 lb / 250 kg	0.2 lb / 0.1 kg	53 lb / 24 kg	\$5,705.00
138705	502654-0002	MSI-9300 2,000 lb F/A	2,000 lb / 1,000 kg	1.0 lb / 0.5 kg	53 lb / 24 kg	5,705.00
138706	502654-0003	MSI-9300 5,000 lb F/A	5,000 lb / 2,500 kg	1.0 lb / 0.5 kg	62 lb / 28 kg	5,810.00
138707	502654-0004	MSI-9300 10,000 lb F/A	10,000 lb / 5,000 kg	2.0 lb / 1.0 kg	62 lb / 28 kg	6,015.00
138409	502518-0005	MSI-9300 20,000 lb F/A	20,000 lb / 10,000 kg	5.0 lb / 2.0 kg	105 lb / 47 kg	7,135.00
138410	502518-0006	MSI-9300 30,000 lb F/A	30,000 lb / 15,000 kg	10 lb / 5.0 kg	125 lb / 55 kg	7,440.00
138419*	502518-0015	MSI-9300 50,000 lb F/A	50,000 lb / 25,000 kg	10 lb / 5.0 kg	235 lb / 106 kg	9,785.00
138420**	502518-0016	MSI-9300 70,000 lb F/A	70,000 lb / 35,000 kg	20 lb / 10 kg	270 lb / 121 kg	11,725.00
138421***	502518-0017	MSI-9300 100,000 lb F/A	100,000 lb / 50,000 kg	20 lb / 10 kg	420 lb / 189 kg	18,250.00

## Options/Accessories

PART #	MSI PART #	DESCRIPTION	EST. SHIP WEIGHT	PRICE
159625	N/A	MSI-9850 RF Remote Indicator (wall or desk mount)	10 lb / 5 kg	\$2,440.00
138486	502541-0001	MSI-9750 RF Portable Indicator	2.2 lb / 1 kg	1,830.00
139056	502855-0006	MSI-RF Scoreboard, red LED, 4 in, six-digit display	21 lb / 10 kg	2,950.00
139052	502855-0002	MSI-RF Scoreboard, red LED, 6 in, six-digit display	37 lb / 17 kg	3,360.00
150367	D00559-0004	Battery assembly, 12 Volt rechargeable	6.6 lb / 3 kg	100.00
148624	501705-0001	RS-232/RS-485 Serial Cable	1 lb / 0.45 kg	100.00
138006	502221-0001	Universal 115/230VAC, 50/60 Hz battery charger (NA Plug Standard)	4 lb / 2 kg	255.00
138007	502221-0002	Universal 115/230VAC, 50/60 Hz battery charger (UK Plug)	4 lb / 2 kg	255.00
138008	502221-0003	Universal 115/230VAC, 50/60 Hz battery charger (EC Plug)	4 lb / 2 kg	255.00
138341	502488-0001	Universal mounting bracket for MSI-9850 RF remote indicator	2.2 lb / 1 kg	132.00
159221		Universal Crane Scale Transport	180 lb / 82 kg	920.00

\* 490% of kg capacity

\*\* 475% of lb capacity/430% of kg capacity

\*\*\* 450% of kg capacity

# MSI-9300HT Hi-Torque Port-A-Weigh Plus CellScale™ RF

## Specifications

**Accuracy:**

±(0.1% +1 d) of applied load

**Resolution:**

3000 to 5000 d standard (Up to 10,000 d available)

**Enclosure:**

NEMA 4, IP66, marine grade 356 alloy anodized cast aluminum

**Lifting Eye, Shackle & Hook:**

Shackle is optional and Crosby fixed hook provided as standard.

**Design Overload:**

200% Safe / 500% Ultimate

**Functions:**

POWER, ZERO, NET/GROSS, TARE and Programmable TEST/USER

**Display:**

6 digit, 1.2 in (30 mm) LED with 14 feature annunciators and programmable brightness control

**Displayable Units:**

Pounds or kilograms selectable

**Power:**

12 Volt rechargeable battery, 115-230 VAC battery charger included

**Operating Time:**

Up to 30 hours between charging with typical use

**Operating Temperature:**

-4°F to 140°F (-20°C to 60°C)

**Calibration:**

Digital via MSI-9750A or MSI-9850 RF indicators or via serial interface with PC terminal program.

**Filtering:**

LO, Medium and HI selectable

**Radio Link:**

FHSS at 2.4 GHz

Radio Effective Range:

Typically 500 ft (150 m) indoor, 1000 ft (300 m) outdoor with standard antennas.

**Warranty:**

One-year limited



## Standard Features

- Crane Unit with 2.4 GHz Spread Spectrum transceiver
  - Six digit, 30 mm (1.2 in) LED display and annunciators
  - Top shackle interface and fixed bottom hook
- (Note: Top shackle not included, see Options)*
- 12 Volt rechargeable battery and Universal 115/230VAC, 50/60 Hz battery charger (NA Plug Standard)
  - Hi-Torque load train designed for use with powered rotation

## Additional Options

### (Contact MSI for application consultation)

- RF remote crane unit control, includes On/Off, Zero, Tare, Net/Gross, Total, and programmable function keys
- Anti-Heat shielding for high temperature applications
- Substitute bottom hook with shackle
- Oversized top or shackle
- Oversized bottom hooks
- Universal direct power supply; 85-265 VAC, 47-440 Hz / 130-300 VDC
- Wireless 802.11 b/g Ethernet connectivity
- Low headroom top adapter

*(Note: Communicates with MSI-9850, 9750A, Remote RF Indicators or MSI RF Scoreboard. Each sold separately)*

# MSI-9300HT Hi-Torque Port-A-Weigh Plus CellScale™ RF

## Part Number/Price

PART #	MSI PART #	DESCRIPTION	CAPACITY	RESOLUTION	EST. SHIP WEIGHT	PRICE
138440	502519-0001	MSI-9300HT 30,000 lb F/A	30,000 lb / 15,000 kg	10 lb / 5.0 kg	125 lb / 55 kg	\$9,995.00
138441	502519-0002	MSI-9300HT 70,000 lb F/A	70,000 lb / 35,000 kg	20 lb / 10 kg	270 lb / 121 kg	12,595.00
162377	N/A	MSI-9300HT 120,000 lb F/A	120,000 lb/60,000 kg	50 lb/20 kg	550 lb / 250 kg	Consult

## Options/Accessories

PART #	MSI PART #	DESCRIPTION	EST. SHIP WEIGHT	PRICE
141992	10539	Top lifting shackle Crosby® G2130 17 ton for 30,000 lb cap unit	19.5 lb / 8.9 kg	\$325.00
146335	23650-0040	Top lifting shackle Crosby® G2140 40 ton for 70,000 lb cap unit	34 lb / 15 kg	950.00
146336	23650-0050	Top lifting shackle Crosby® G2140 55 ton for 120,000 lb cap unit	104 lb / 47 kg	1,247.50
159625	N/A	MSI-9850 RF Remote Indicator (wall or desk mount)	10 lb / 5 kg	2,440.00
138486	502541-0001	MSI-9750 RF Portable Indicator	2.2 lb / 1 kg	1,830.00
139056	502855-0006	MSI-RF Scoreboard, red LED, 4 in, 6 digit display	21 lb / 10 kg	2,950.00
139052	502855-0002	MSI-RF Scoreboard, red LED, 6 in, 6 digit display	37 lb / 17 kg	3,360.00
148624	501705-0001	RS-232/RS-485 Serial Cable	1 lb / 0.45 kg	100.00
150367	D00559-0004	Battery assembly, 12 Volt rechargeable	6.6 lb / 3 kg	100.00
138006	502221-0001	Universal 115/230VAC, 50/60 Hz battery charger (NA Plug standard)	4 lb / 2 kg	255.00
138007	502221-0002	Universal 115/230VAC, 50/60 Hz battery charger (UK Plug)	4 lb / 2 kg	255.00
138008	502221-0003	Universal 115/230VAC, 50/60 Hz battery charger (EC Plug)	4 lb / 2 kg	255.00
138341	502488-0001	Universal mounting bracket for MSI-9850 RF remote indicator	2.2 lb / 1 kg	132.00
159221		Universal Crane Scale Transport Cart	180 lb / 82 kg	920.00

# MSI-6260CS Trans-Weigh CellScale™ RF

## Specifications

**Accuracy:**

± (0.1% +1 d) of applied load

**Resolution:**

3000 to 5000 d standard (Up to 10,000 d available)

**Enclosure:**

NEMA 4, IP66, marine grade 356 alloy anodized cast aluminum

**Lifting Eye, Shackle & Hook:**

Crosby® or equivalent with 360° thrust-bearing swivel hook

**Design Overload:**

200% Safe / 500% Ultimate (except where noted)

**Functions:**

POWER On/Off (all other scale functions are controlled from other optional networked MSI scale indicators MSI-9850 and/or MSI-9750A)

**Displayable Units:**

Pounds or kilograms selectable

**Power:**

12 Volt rechargeable battery, 115/230VAC battery charger included

**Operating Time:**

Up to 40 hours between charging with typical use

**Operating Temperature:**

-4°F to 140°F (-20°C to 60°C)

**Calibration:**

Digital via MSI-9750A or MSI-9850 RF indicators or via serial interface with PC terminal program

**Radio Link:**

FHSS at 2.4 GHz

**Radio Link Effective Range:**

Typically 500 ft (150 m) indoor, 1000 ft (300 m) outdoor with standard antennas

**Warranty:**

One-year limited

**Approvals:**

NTEP CC 07-007: 5,000 to 70,000 lb



## APPROVALS



5,000 to 70,000 lb

## Standard Features

- Crane unit with 2.4 GHz spread spectrum transceiver
- Top lifting eye or shackle, and bottom thrust bearing swivel hook
- 12 Volt rechargeable battery and Universal 115/230 VAC, 50/60 Hz battery charger (NA Plug Standard)

## Additional Options

(Contact MSI for application consultation)

- NTEP Certified configuration
- Anti-Heat shielding for high temperature applications
- Substitute bottom swivel hook with shackle
- Oversized top lifting eye or shackle
- Oversized bottom hook
- Low headroom top adapter
- Universal direct power supply; 85-265VAC, 47-440 Hz / 130-300VDC
- Wireless 802.11 b/g Ethernet connectivity
- MSI-6260CS Retrofit Kit - conversion kit to upgrade existing MSI-4260 crane scales to MSI-6260CS

*Note: Communicates with MSI-9850, 9750A, RF Indicators or MSI RF Scoreboard. Each sold separately*



# MSI-6260CS Trans-Weigh CellScale™ RF

## Part Number/Price

PART #	MSI PART #	DESCRIPTION	CAPACITY	RESOLUTION	EST. SHIP WEIGHT	PRICE
138729	502655-0001	MSI-6260 500 lb F/A	500 lb / 250 kg	0.2 lb / 0.1 kg	53 lb / 24 kg	\$4,790.00
138730	502655-0002	MSI-6260 2,000 lb F/A	2,000 lb / 1000 kg	1.0 lb / 0.5 kg	53 lb / 24 kg	4,790.00
138731	502655-0003	MSI-6260 5,000 lb F/A	5,000 lb / 2500 kg	1.0 lb / 0.5 kg	62 lb / 28 kg	4,890.00
138732	502655-0004	MSI-6260 10,000 lb F/A	10,000 lb / 5000 kg	2.0 lb / 1.0 kg	62 lb / 28 kg	5,095.00
138506	502559-0005	MSI-6260 20,000 lb F/A	20,000 lb / 10,000 kg	5.0 lb / 2.0 kg	105 lb / 47 kg	6,215.00
138507	502559-0006	MSI-6260 30,000 lb F/A	30,000 lb / 15,000 kg	10 lb / 5.0 kg	125 lb / 55 kg	6,520.00
138508*	502559-0007	MSI-6260 50,000 lb F/A	50,000 lb / 25,000 kg	10 lb / 5.0 kg	235 lb / 106 kg	8,870.00
138509**	502559-0008	MSI-6260 70,000 lb F/A	70,000 lb / 35,000 kg	20 lb / 10 kg	270 lb / 121 kg	10,805.00
138510***	502559-0009	MSI-6260 100,000 lb F/A	100,000 lb / 50,000 kg	20 lb / 10 kg	420 lb / 189 kg	17,335.00

## Options/Accessories

PART #	MSI PART #	DESCRIPTION	EST. SHIP WEIGHT	PRICE
Consult	N/A	RF Remote Control Upgrade (Includes 1 remote)	N/A	\$285.00
138317	N/A	Spare RF Remote Control	1 lb / .5 kg	100.00
159625	N/A	MSI-9850 RF Remote Indicator (wall or desk mount)	10 lb / 5 kg	2,440.00
138486	502541-0001	MSI-9750 RF Portable Indicator	2.2 lb / 1 kg	1,830.00
139056	502855-0006	MSI-RF Scoreboard, red LED, 4 in, 6 digit display	21 lb / 10 kg	2,950.00
139052	502855-0002	MSI-RF Scoreboard, red LED, 6 in, 6 digit display	37 lb / 17 kg	3,360.00
148624	501705-0001	RS-232/RS-485 Serial Cable	1 lb / 0.45 kg	100.00
150367	D00559-0004	Battery assembly, 12 Volt rechargeable	6.6 lb / 3 kg	100.00
138006	502221-0001	Universal 115/230 VAC, 50/60 Hz battery charger (NA Plug Standard)	4 lb / 2 kg	255.00
138007	502221-0002	Universal 115/230 VAC, 50/60 Hz battery charger (UK Plug)	4 lb / 2 kg	255.00
138008	502221-0003	Universal 115/230 VAC, 50/60 Hz battery charger (EC Plug)	4 lb / 2 kg	255.00
138341	502488-0001	Universal mounting bracket for MSI-9850 RF Remote Indicator	2.2 lb / 1 kg	132.00
159221		Universal Crane Scale Transport Cart	180 lb / 82 kg	920.00

\* 490% of Kg capacity

\*\* 475% of lb capacity/430% of Kg capacity

\*\*\* 450% of Kg capacity

# MSI-7300 Dyna-Link 2

Digital Tension Dynamometer

## Specifications

**Accuracy:**

0.1% of rated capacity

**Enclosure:**

NEMA 4, IP65, anodized corrosion-resistant finish

**Material:**

2024 aircraft grade aluminum

**Design Overload:**

200% Safe / 700% Ultimate\* (except where noted)

**Functions:**

On/Off, Zero, Hi-Speed Peak Hold, Setpoints, Total, Tare, Auto-Off, Motion Filter

**Display:**

6 digit, 1.00 in (25.4 mm) LCD

**Displayable Units:**

Pounds, Kilograms, Kilonewtons, Tons, Metric Tons

**LED Annunciators:**

Function 1, Function 2, Setpoint 1, Setpoint 2

**LCD Annunciators:**

Net, Center of Zero, Stable, Battery Test, Peak Hold, Total

**Power:**

Two each "C" alkaline batteries for capacities up to 10,000 lb two each "D" alkaline batteries for capacities 25,000–100,000 lb

**Operating Time:**

From 150 to 300 hours in typical use depending on unit capacity and battery configuration. Less with optional RF Modem Link installed

**Operating Temperature:**

- 4°F to 140°F (-20°C to 60°C)

**Calibration:**

Digital

**Filtering:**

OFF, LO, HI selectable

**Data Output:**

Serial RS-232

**Warranty:**

One-year limited



## Standard Features

- Tension Dynamometer with six-digit 1.00 in (25.4 mm) LCD display
- Two each "C" alkaline batteries for capacities up to 10,000 lb (5,000 kg)
- Two each "D" batteries for capacities 25,000 lb (12,500 kg) and above

## Additional Options

(Contact MSI for application consultation)

- Pair of Crosby® shackles
- Transport case
- RS-232 serial cable
- RF Modem for connectivity with MSI-8000 RF remote display
- RF Scoreboard
- MSI-8000 or MSI-8000HD RF Remote Display RF 2.4 GHz–802.15.4, operating range 100 ft (30 m) typical and MSI-8000HD
- Higher capacity designs available upon request

# MSI-7300 Dyna-Link 2

Digital Tension Dynamometer

## Part Number/Price

PART #	MSI PART #	DESCRIPTION	CAPACITY	RESOLUTION	EST. SHIP WEIGHT	PRICE
139162	502967-0001	MSI-7300 1,000 lb F/A	1,000 lb / 500 kg	0.5 lb / 0.2 kg	8 lb / 3.6 kg	\$1,395.00
139163	502967-0002	MSI-7300 2,500 lb F/A	2,500 lb / 1,250 kg	1 lb / 0.5 kg	9 lb / 4.0 kg	1,395.00
139164	502967-0003	MSI-7300 5,000 lb F/A	5,000 lb / 2,500 kg	2 lb / 1.0 kg	9 lb / 4.0 kg	1,395.00
139165	502967-0004	MSI-7300 10,000 lb F/A	10,000 lb / 5,000 kg	5 lb / 2.0 kg	11 lb / 5.0 kg	1,495.00
139166	502967-0005	MSI-7300 25,000 lb F/A	25,000 lb / 12,500 kg	10 lb / 5 kg	19 lb / 8.6 kg	1,995.00
139167	502967-0006	MSI-7300 50,000 lb F/A	50,000 lb / 25,000 kg	20 lb / 10 kg	29 lb / 13 kg	2,595.00
139168*	502967-0007	MSI-7300 100,000 lb F/A	100,000 lb / 50,000 kg	50 lb / 20 kg	65 lb / 30 kg	3,395.00
<b>Optional Configurations</b>						
139441	503381-0001	MSI-7300 RF module (for connectivity to MSI-8000 RF Remote Display) F/A	1,000 lb / 500 kg	0.5 lb / .2 kg	8 lb / 3.6 kg	1,570.00
139442	503381-0002	MSI-7300 RF module (for connectivity to MSI-8000 RF Remote Display) F/A	2,500 lb / 1,250 kg	1 lb / .5kg	9 lb / 4 kg	1,570.00
139443	503381-0003	MSI-7300 RF module (for connectivity to MSI-8000 RF Remote Display) F/A	5,000 lb / 2,500 kg	2 lb / 1 kg	9 lb / 4 kg	1,570.00
139444	503381-0004	MSI-7300 RF module (for connectivity to MSI-8000 RF Remote Display) F/A	10,000 lb / 5,000 kg	5 lb / 2 kg	11 lb / 5 kg	1,670.00
139445	503381-0005	MSI-7300 RF module (for connectivity to MSI-8000 RF Remote Display) F/A	25,000 lb / 12,500 kg	10 lb / 5 kg	19 lb / 8.6 kg	2,170.00
139446	503381-0006	MSI-7300 RF module (for connectivity to MSI-8000 RF Remote Display) F/A	50,000 lb / 25,000 kg	20 lb / 10 kg	29 lb / 13 kg	2,770.00
139447*	503381-0007	MSI-7300 RF module (for connectivity to MSI-8000 RF Remote Display) F/A	100,000 lb / 50,000 kg	50 lb / 20 kg	65 lb / 30 kg	3,570.00
152794*	N/A	MSI-7300 RF module (for connectivity to MSI-8000 RF Remote Display) F/A	120,000 lb / 60,000 kg	50 lb / 20 kg	57 lb / 26 kg	Consult
152795*	N/A	MSI-7300 RF module (for connectivity to MSI-8000 RF Remote Display) F/A	180,000 lb / 90,000 kg	100 lb / 50 kg	74 lb / 36 kg	Consult
152796*	N/A	MSI-7300 RF module (for connectivity to MSI-8000 RF Remote Display) F/A	260,000 lb / 130,000 kg	100 lb / 50 kg	100 lb / 45 kg	Consult
152797*	N/A	MSI-7300 RF module (for connectivity to MSI-8000 RF Remote Display) F/A	380,000 lb / 190,000 kg	200 lb / 100 kg	169 lb / 77 kg	Consult
152798**	N/A	MSI-7300 RF module (for connectivity to MSI-8000 RF Remote Display) F/A	550,000 lb / 275,000 kg	200 lb / 100 kg	336 lb / 152 kg	Consult

\* 500% Ultimate overload

\*\* 440% Ultimate overload

# MSI-7300 Dyna-Link 2

Digital Tension Dynamometer

## Options/Accessories

PART #	MSI PART #	DESCRIPTION	EST. SHIP WEIGHT	PRICE
151357	10541	Shackle anchor, bolt type 3.25 ton for 500-5000 lb unit	3 lb / 1.4 kg	\$40.00/ea
151355	10538	Shackle anchor, bolt type 6.5 ton for 10,000 lb unit	6 lb / 2.7 kg	82.50/ea
141992	10539	Shackle anchor, bolt type 17 ton for 25,000 lb unit	39 lb / 17.7 kg	325.00/ea
151356	10540	Shackle anchor, bolt type 25 ton for 50,000 lb unit	63 lb / 28.6 kg	512.50/ea
146336	23650-0050	Shackle anchor, bolt type 55 ton for 100,000 lb unit	104 lb / 47 kg	1,247.50/ea
83454	—	Shackle anchor, bolt type 85 ton for 180,000 lb unit	125 lb / 57 kg	3,695.00/pr
83455	—	Shackle anchor, bolt type 120 ton for 260,000 lb unit	185 lb / 84 kg	4,459.00/pr
83456	—	Shackle anchor, bolt type 175 ton for 380,000 lb unit	350 lb / 159 kg	10,840.00/pr
83458	—	Shackle anchor, bolt type 250 ton for 550,000 lb unit	700 lb / 318 kg	17,984.00/pr
139381	503208-0001	MSI-8000 RF Remote Display (requires MSI-7300 equipped with optional RF Modem)	5 lb / 2.25 kg	1,115.00
153591	—	MSI-8000HD RF Remote Display, A/C Powered	5 lb / 2.25 kg	1,220.00
162059	—	Transport case for 500-10,000 lb capacity unit with Pluck and Pick foam	N/A	230.00
162113	—	Precision cut heavy duty foam. For use with 162059 case and 1 k DynaLinks	N/A	75.00
162114	—	Precision cut heavy duty foam. For use with 162059 case and 2.5 k / 5 k DynaLinks	N/A	75.00
162115	—	Precision cut heavy duty foam. For use with 162059 case and 10 k DynaLinks	N/A	75.00
145076	14317	Transport case for 25,000 and 50,000 lb capacity unit	N/A	350.00
145073	14311	Transport case for 100,000 lb capacity unit	N/A	350.00
139470	503414-0002	RS-232 serial cable for MSI-7300	1 lb / 0.45 kg	125.00
162899	N/A	Red LED, 4 in (101 mm) six-digit display	21 lb / 10 kg	2,195.00
162897	N/A	Red LED, 6 in (152 mm) six-digit display	37 lb / 17 kg	2,650.00
149549	503486-0001	Universal 115/ 230 VAC 50/60 Hz (NA plug standard) battery charger for MSI-8000 remote display	3 lb / 1.4 kg	120.00
150964	503489-0001	RS-232 13 ft (4 m) serial cable for MSI-8000	1 lb / 0.45 kg	100.00

# MSI-8000

RF Remote Display

## Specifications

**Enclosure:**

NEMA 4, IP65

**Weight:**

0.98 lbs (445 grams)

**Keypad:**

On/Off, Zero (100%), Tare, Print, and Two user-defined keys for the following functions: peak hold, high resolution, total, view total, net/gross, units switching

**Display:**

Six-digit 1.0 in (26.4 mm) LCD

**Units Displayed:**

Pounds, kilograms, tons, metric tons, kilonewtons

**Annunciators:**

Stable, COZ, low battery, peak, net, kg, kN, lb, M, ton, setpoint, function LEDs

**Power:**

Integral lithium ion battery

**Operating Time:**

Up to 24 hours of continuous use (15 minute auto-shutoff with non-use)

**Operating Temperature:**

-4°F to 140°F (-20°C to 60°C)

**RF Radio Link:**

2.4 GHz 802.15.4

**RF Effective Range:**

Typically 100 or more feet (33 m)

**Connector:**

Four-pin Turck connector for charging and RS-232 communication

**Warranty:**

One-year limited



## Standard Features

- Handheld RF remote display with six-digit 1.0 in (26.4 mm) LCD screen
- Membrane keypad for remote control functionality
- User definable function keys for added versatility
- Universal 115/230 VAC, 50/60Hz battery charger (NA plug standard)

## Part Number/Price

PART #	MSI PART #	DESCRIPTION	EST. SHIP WEIGHT	PRICE
139381	503208-0001	MSI-8000 RF remote display (requires ScaleCore™ device equipped with RF modem)		\$1,115.00

## Options/Accessories

PART #	MSI PART #	DESCRIPTION	PRICE
149549	503486-0001	Universal 115/230 VAC 50/60 Hz (NA Plug) battery charger for MSI-8000 RF remote display	\$120.00
149550	503486-0002	Universal 115/230 VAC 50/60 Hz (EC plug) battery charger for MSI 8000 RF remote display	120.00
150964	503489-0001	DB9 female serial interface cable for MSI-8000 RF remote display	100.00

# MSI-8000HD

Indicator/Remote Display

## Specifications

**Enclosure:**

NEMA 4, IP68 milled anodized aluminum with O-ring gaskets

**Keypad:**

On/Off, Zero (100%), Tare, Print, and Two user-defined keys for the following functions: peak hold, high resolution, total, view total, net/gross, units switching

**Display:**

Six-digit 1.0 in (26.4 mm) LCD

**Units Displayed:**

Pounds, kilograms, tons, metric tons, kilonewtons

**Annunciators:**

Stable, COZ, peak, kg, kN, lb, M, ton, setpoint, function LEDs. Channels: 1, 2, 3, 4, TTL

**Power:**

90-267VAC, 9-36VDC, 18-72VDC, 120-300VDC

**Operating Temperature:**

-4°F to 140°F (-20°C to 60°C)

**RF Remote Channels:**

Up to four remote sensors, monitored individually, in pairs, or sum all (non-A/D version only)

**Service Counters**

A/D version only

**A/D Inputs:**

Two independent or summing load cell inputs

**Excitation:**

4.8V current limited and over-voltage protected

**Filtering:**

Off, Low, Hi-1, Hi-2

**RF Radio Link:**

2.4 GHz 802.15.4

**RF Effective Range:**

Typically 100 or more feet (33 m)

**Data I/O:**

Dual RS-232 comm ports

**Warranty:**

One-year limited

**Approvals:**

Pending



Shown with optional tilt stand.

## Standard Features

- Indicator or Handheld RF remote display with six-digit 1.0 in (26.4 mm) LCD screen
- IP68 milled aluminum enclosure
- Membrane keypad for remote-control functionality
- User definable function keys for added versatility

## Part Number/Price

PART #	DESCRIPTION	EST. SHIP WEIGHT	PRICE
153591	MSI-8000HD ScaleCore RF remote display AC powered ( no A/D)	5 lb	\$1,220.00
154853	MSI-8000HD ScaleCore RF remote display, battery powered (no A/D)	5 lb	1,320.00
158427	MSI-8000HD digital weight indicator, two A/D inputs, AC powered (Non-RF)	5 lb	1,380.00
158428	MSI-8000HD digital weight indicator, two A/D inputs, battery powered (Non-RF)	5 lb	1,480.00

## Options/Accessories

PART #	DESCRIPTION	PRICE
155173	MSI-8000HD tilt stand option kit	\$61.00
155193	MSI-8000HD Ethernet TCP/IP option kit	360.00
148624	MSI-8000HD serial RS-232 cable	100.00
158779	MSI-8000HD coil relay option kit, 250 VAC/30 VDC 5A or 100 VDC 0.4A	290.00
158780	MSI-8000HD solid state relay option kit, 60 Vpk 2.7A	290.00
158781	MSI-8000HD solid state relay option kit, 200 Vpk 0.9A	290.00
149549	Universal 115/230 VAC 50/60 Hz (NA plug standard) battery charger for MSI-8000HD battery powered device	120.00
149550	Universal 115/230 VAC 50/60 Hz (International Plugs) battery charger for MSI-8000HD battery powered device	120.00

### Specifications

---

**Power:**

5-6VDC, 7-36VDC 85-265 VAC

**Excitation Voltage:**

Transmitter: +4.8VDC, 16x 350Ω or 32x 700Ω load cells

**Standard Antenna:**

1/2 wave 2dBi, articulated

**Frequency:**

Direct sequence spread spectrum at 2.4 GHz, 802.15.4 license free

**Effective Range:**

100 ft or more

**Digital I/O:**

Three coil relays available on select models

**Circuit Protection:**

RFI, EMI, ESD protection

**Weight:**

TBD

**Serial Port:**

Full duplex RS-232

**Operating Temperature:**

-40°F to 185°F (-40°C to 85°C)

**Enclosure:**

NEMA4 (IP66), aluminum black powder coated (excludes wall cube model)

**Warranty:**

One-year limited warranty



### Standard Features

---

- Works with any basic digital weight indicator
- Excitation to load cell(s) provided by the transmitter, not the indicator
- Each transmitter/receiver set is individually paired and will not interfere with another set
- Auto-off mode - selectable for 15, 30, 45, 60 minutes or off
- Auto-sleep mode - power down during non-use, power up with weight change, or key press

### Part Number/Price

PART #	DESCRIPTION	EST. SHIP WEIGHT	PRICE
<b>TRANSMITTERS</b>			
<b>5-6 VDC Power Input</b>			
160330	Single-channel transmitter, no relays. RF 802.15.4, 2.4 GHz	2 lbs	\$775.00
159207	Four-channel transmitter, no relays. RF 802.15.4, 2.4 GHz	2 lbs	825.00
161949	Four-channel transmitter, includes three coil relays. RF 802.15.4, 2.4 GHz	2 lbs	950.00
<b>7-36 VDC Power Input</b>			
160329	Single-channel transmitter, no relays. RF 802.15.4, 2.4 GHz	2 lbs	825.00
159470	Four-channel transmitter, no relays. RF 802.15.4, 2.4 GHz	2 lbs	850.00
161951	Four-channel transmitter, includes three coil relays. RF 802.15.4, 2.4 GHz	2 lbs	995.00
<b>85-265 VAC Power Input</b>			
160328	Single-channel transmitter, no relays. RF 802.15.4, 2.4 GHz	2 lbs	850.00
159469	Four-channel transmitter, no relays. RF 802.15.4, 2.4 GHz	2 lbs	875.00
161950	Four-channel transmitter, includes three coil relays. RF 802.15.4, 2.4 GHz	2 lbs	1,025.00
<b>RECEIVERS</b>			
<b>5-6 VDC Power Input</b>			
160337	Receiver to provide a mV signal to a digital weight indicator. RF 802.15.4, 2.4GHz	2 lbs	875.00
160334	Receiver to provide an analog output signal: 4-20 mA, 0-20 mA, 0-5VDC, 0-10VDC, +/- 5VDC, +/- 10VDC. RF 802.15.4, 2.4 GHz	2 lbs	925.00
160016	Receiver to provide an analog output signal: 4-20 mA, 0-20 mA, 0-5VDC, 0-10VDC, +/- 5VDC, +/- 10VDC. Includes three coil relays. RF 802.15.4, 2.4 GHz	2 lbs	1,050.00
<b>7-36 VDC Power Input</b>			
160336	Receiver to provide a mV signal to a digital weight indicator. RF 802.15.4, 2.4GHz	2 lbs	950.00
160333	Receiver to provide an analog output signal: 4-20 mA, 0-20 mA, 0-5VDC, 0-10VDC, +/- 5VDC, +/- 10VDC. RF 802.15.4, 2.4 GHz	2 lbs	1,050.00
159476	Receiver to provide an analog output signal: 4-20 mA, 0-20 mA, 0-5VDC, 0-10VDC, +/- 5VDC, +/- 10VDC. Includes three coil relays. RF 802.15.4, 2.4 GHz	2 lbs	1,175.00
<b>85-265 VAC Power Input</b>			
160335	Receiver to provide a mV signal to a digital weight indicator. RF 802.15.4, 2.4GHz	2 lbs	995.00
160332	Receiver to provide an analog output signal: 4-20 mA, 0-20 mA, 0-5VDC, 0-10VDC, +/- 5VDC, +/- 10VDC. RF 802.15.4, 2.4 GHz	2 lbs	1,100.00
159475	Receiver to provide an analog output signal: 4-20 mA, 0-20 mA, 0-5VDC, 0-10VDC, +/- 5VDC, +/- 10VDC. Includes three coil relays. RF 802.15.4, 2.4 GHz	2 lbs	1,275.00

### Options/Accessories

PART #	DESCRIPTION	PRICE
162172	Charger, TranSend for 6V SLA battery	\$50.00
162173	Battery, TranSend 6V SLA	95.00
162175	Enclosure, TranSend for 6V SLA battery	280.00
150964	RS-232 13 ft (4m) serial cable with 9-Pin (female) connector	100.00
150965	RS-232 13 ft (4m) serial cable with 9-Pin (male) connector	100.00
160109	AC adapter, TranSend 6V	40.00
162178	Antenna kit, remote standard antenna	250.00
139309	Antenna kit, long range Omni with 3M coax	405.00
139310	Antenna kit, corner reflector 9 dbi with 3M coax	Consult
139311	Antenna kit, corner reflector 12 dbi with 3M coax	Consult
139312	Antenna kit, Yagi 15 dbi with 3M coax	Consult
144345	30 M coaxial cable, for use with non-vehicle mount antenna kits	375.00
139313	Antenna kit, vehicle mount. 5 dbi with 5M coaxial cable	Consult
162177	Cordset, TranSend. Pre-wired for use with single channel transmitters or non-relay based receivers	100.00
162184	Load cell connector, TranSend. Field wireable, 4-6 mm straight. For use with single channel transmitters and all receivers.	45.00
162185	Load cell connector, TranSend. Field wireable, 6-8 mm straight. For use with single channel transmitters and all receivers.	45.00
162186	Load cell connector, TranSend. Field wireable, 4-6 mm right angle. For use with single channel transmitters and all receivers.	45.00
162187	Load cell connector, TranSend. Field wireable, 6-8 mm right angle. For use with single channel transmitters and all receivers.	45.00



# MSI-9850 CellScale™ RF Digital Indicator

## Specifications

### Enclosure:

NEMA 4, IP65 milled anodized aluminum with O-ring gaskets  
NEMA 6, IP67 with optional long-range antenna

### Weight:

5.0 lb (2.8 kg)

### Keypad:

33 keys—12 key alphanumeric, 4 cursor keys, 7 control keys and 10 user programmable keys. Password protected with lock feature

### Weight Display:

5 digit, 1.2 in (30 mm) high numeric weight LED, 4 alphanumeric 0.5 in (13 mm) high data LED, 6 LED function select annunciators, 10 LED annunciators, Low battery LED indicator

### Information Display:

1.4 x 2.6 in (36 x 67 mm) backlit LCD. Capable of 8 lines of 21 characters each backlight selectable On, Off or Automatic

### Power Input:

Internal AC/DC Power Supply: 85-265 VAC, 47-440 Hz/130-300 VDC. Also included an independent 7-25 VDC power input (requires optional power/switch interface cable)

### Operating Temperature:

4°F to 158°F (-20°C to 70°C)

### Radio Link:

FHSS at 2.4 GHz (up to 64 network selections)

### Radio Link Effective Range:

Typically 500 ft (150 m) indoor, 1000 ft (300 m) outdoor with standard antennas. (See optional antennas for longer range)

### Standard Antenna:

1/2 wave 2 dBi, articulated

### RFI/EMI Shielding:

Exceeds NIST HB44 and CE Standards

### Connectors:

RS-232, Turck compatible Pico connector

### Warranty:

One-year limited

### Approvals:

NTEP CC 05-077



## APPROVALS



## Standard Features

- Compatible with MSI-6260CS, MSI-9300 and MSI-9000 CellScale
- Six-digit 1.2 in (30 mm) LED display
- 1.4 x 2.6 in (36 x 67 mm) information LCD display
- 2.4 GHz Spread Spectrum transceiver
- RS-232 data I/O with real time clock
- NEMA 4, IP65 enclosure
- Power input 85-265 VAC, 47-440 Hz / 130-300 VDC; 8 ft / 2.4 m power cable included (North American Plug Standard)

## Additional Options

### (Contact MSI for application consultation)

- NTEP Certified
- RF remote controller (control for On/Off, Zero, Tare and other functions. 10 m Operating Range)
- Long range antenna, omni-directional with 9dBi
- WiFi Ethernet Connectivity (802.11b)
- Hardwired Ethernet output connection
- Single 4-20mA output, provides programmable current output
- Bar code scanner
- Set-point relays, provides up to eight setpoint relay outputs for direct interfacing to external devices
- External audible alarm (activates with setpoint control)
- Universal mounting bracket for either desktop or wall / bulkhead mount
- Optional isolated and non-isolated DC power supplies

# MSI-9850 CellScale™ RF Digital Indicator

## Part Number/Price

PART #	MSI PART #	DESCRIPTION	CAPACITY	RESOLUTION	EST. SHIP WEIGHT	PRICE
159625	N/A	MSI-9850 RF Remote Indicator	N/A	N/A	10 lb / 4.5 kg	\$2,2440.00

## Options/Accessories

PART #	MSI PART #	DESCRIPTION	PRICE
141558	10082	External setpoint relay output cable, 6.5 ft / 2 m, RS-232, 9-Pin	100.00
138358	502513-0001	RS-232, 13 ft / 4 m cable with DB-9 connector	100.00
138625	502598-0001	RF remote controller (control for On/Off , Zero, Tare and other functions. 10 m operating range)	300.00
143466	12147	Long-range antenna, omni-directional with 9 dBi gain, includes 10 ft / 3 m coaxial cable	415.00
Consult	Consult	9 dBi or 14 dBi gain corner reflector antenna	Consult
Consult	Consult	5 dBi gain vehicle/cab mount whip antenna, includes 17 ft / 5.2 m coaxial cable	Consult
139032	502835-0001	Hardwired Ethernet output connection, includes connector	345.00
139033	502835-0002	WiFi Ethernet connectivity (802.11b - contact factory for assistance)	345.00
Consult	Consult	Single 4-20 mA output. Provides programmable current output	Consult
Consult	Consult	Barcode scanner (several options available)	Consult
Consult	Consult	Internal setpoint relays, provides up to eight setpoint relay outputs for direct interfacing to external devices	Consult
Consult	Consult	Control kit, provides remote I/O relay board for interfacing to setpoints (Note: I/O modules not included)	Consult
138628	502599-0001	External audible alarm (activates with setpoint control)	370.00
138341	502488-0001	Universal mounting bracket for either desktop or wall / bulkhead mount (specify type)	132.00
138351	502499-0001	Vehicle or wall mount bracket stand	132.00
138631	502600-0003	Non-Isolated 7-25VDC power input, includes 13 ft / 4 m un-terminated DC input cable	132.00
138632	502600-0004	Isolated 10-36VDC power input, includes 13 ft / 4 m un-terminated DC input cable	132.00
138633	502600-0005	Isolated 20-72VDC power input, includes 13 ft / 4 m un-terminated DC input cable	205.00

# MSI-9750A CellScale™ RF Portable Indicator

## Specifications

### Enclosure:

NEMA 3, IP54 ,Rugged Molded PVC, O-ring gasketed.

### Dimensions:

4.6 x 10.3 x 2.4 in (117 x 262 x 60.5 mm)

### Weight:

2.2 lb (1 kg)

### Keypad:

24 keys—11 key alphanumeric, 7 control keys and 6 user programmable keys.  
Password protected with lock feature

### Display:

1.4 x 2.6 in (36 x 67 mm) backlight LCD capable of 8 lines, 21 characters each.  
Backlight selectable On, Off or Automatic. Red/Green LED battery charging indicator

### Power:

Rechargeable 6 cell NiMH battery pack (AC Adapter/Battery Charger Input Included)

### Operating Time:

Up to 8 hours typical use. Selectable automatic shut off for battery conservation

### Operating Temperature:

-4° to 158°F (-20° to 70°C)

### Radio Link:

FHSS at 2.4 GHz (Up to 64 network selections)

### Radio Effective Range:

Typically 500 ft (150 m) indoors, 1000 ft (300 m) outdoors with standard antennas

### RFI/EMI Shielding:

Exceeds NIST HB44 and CE Standards

### Connectors:

Charger Input: Standard 2.5 mm coaxial; RS-232: Standard DB-9 male

### Warranty:

One-year limited

### Approvals:

NTEP CC 05-077



## Standard Features

- Compatible with MSI-6260CS, MSI-9300 and MSI-9000 CellScale
- 1.4 x 2.6 in (36 x 67 mm), eight line, 21 character LCD display
- 2.4 GHz Spread Spectrum transceiver
- Power supply: six cell NiMH battery pack
- Charger board: SMD NiMH fast charge (charges battery pack in two hours or less)
- RS-232 data I/O
- Real time clock
- NEMA 3, IP54 enclosure
- AC adapter / battery charger; 90-264 VAC, 47-63 Hz (NA Plug Standard)

## Part Number/Price

PART #	MSI PART #	DESCRIPTION	CAPACITY	RESOLUTION	EST. SHIP WEIGHT	PRICE
138486	502541-0001	MSI-9750 RF Portable Indicator	N/A	N/A	2.2 lb / 1 kg	\$1,830.00

## Options/Accessories

PART #	MSI PART #	DESCRIPTION	EST. SHIP WEIGHT	PRICE
<b>Accessories</b>				
143709	12431	Replacement NiMH battery pack	1 lb / 0.45 kg	\$121.00
139484	503441-0001	AC adapter/battery charger input, 90–264 VAC, 47–63 Hz (NA plug standard)	1 lb / 0.45 kg	100.00

# MSI-9000 CellScale™

## Specifications

### Enclosure:

NEMA 4, IP65 milled anodized aluminum with O-ring gaskets  
NEMA 6, IP67 with optional long range antenna

### Weight:

3.5 lb (1.6 kg)

### Annunciators:

Eight LED status lamps for Power, Setpoints, Comm Port, Excitation & RF Modem

### Real-Time Clock:

USA or European format programmable

### Power Input:

9-30VDC (Internal 85-265VAC power supply optional)

### Operating Temperature:

-4°F to 158°F (-20°C to 70°C)

### Scale Inputs:

Two sensor inputs and 6 terminal connections

### Excitation:

5V (+5V relative to ground)

### Calibration:

Digital via input comport or RF with other CellScale weighing components.  
Programmable calibration settings, include: AZM, Motion, Filter, Zero, Units, Capacity and Divisions

### Digital Filtering:

Two-stage programmable digital filtering

### Totalization, Statistics and Product IDs:

Push-button or automatic with each ID register. Up to 32 alphanumeric ID registers

### Radio Link:

FHSS at 2.4GHz (up to 64 network selections)

### Radio Link Effective Range:

Typically 500 ft (150 m) indoor, 1000 ft (300 m) outdoor with standard antennas. (See optional antennas for longer range)

### Standard Antenna:

1/2 wave 2dBi, articulated

### RFI/EMI Shielding:

Exceeds NIST HB44 and CE Standards

### Data I/O:

Two programmable comports supporting RS-232 or RS-422

### Push Button Inputs:

Two inputs on power connector and 1 isolated input on setpoints connector

### Connectors:

12-pin MIL-C-26482 for load sensor input Turck compatible Pico for RS-232 output

### Math Channels:

Eight math channels programmable for arithmetic formula processing

### Internal Setpoints:

Three 60V at 350 mA internal programmable solid state relay contacts

### Warranty:

One-year limited

### Approvals:

NTEP CC 05-077



## APPROVALS



## Standard Features

- 2.4 GHz frequency hopping spread spectrum
- Two scale inputs and excitation with remote sensing (see accessories for mating connector)
- Power/switch cable, 13 ft (4 m) for 9-30 VDC input with two programmable switch inputs
- RS-232, RS-422 and RS-485 I/O with 13 ft (4 m) interface cable
- Three internal solid state relays for set-point control
- Real time clock
- NEMA 4, IP65 enclosure (NEMA 6, IP67 with long range antenna)

# MSI-9000 CellScale™

## Part Number/Price

PART #	MSI PART #	DESCRIPTION	EST. SHIP WEIGHT	PRICE
138361	502514-0001	MSI-9000, Two-channel A/D 9-30 VDC (consult for other configurations)	7 lb (3.5 kg)	\$2,750.00

## Options/Accessories (Contact MSI for application consultation)

PART #	MSI PART #	DESCRIPTION	PRICE
Consult	Consult	NTEP approved (contact factory for specifications)	Consult
Consult	Consult	Internal AC/DC power supply (85-265VAC, 47-440 Hz / 130-300VDC) includes a separate, independent 9-30VDC power input	Consult
Consult	Consult	External 85-265 VAC, 47-440 Hz / 130-300VDC power supply for indoor and outdoor installations	Consult
Consult	Consult	Long Range Antenna, 300m-500m omni-directional with 9dBi gain, includes 10 ft / 3 m coaxial cable	Consult
Consult	Consult	9dBi or 14dBi gain corner reflector antenna	Consult
Consult	Consult	5dBi gain vehicle/cab mount whip antenna, includes 17 ft / 5.2 m coax cable	Consult
Consult	Consult	Single or Dual 4-20mA output. Provides programmable current output for direct connection to PLC's and other data acquisition equipment. Note: See 4-20 mA Option specification sheet for available product configurations	Consult
Consult	Consult	Unterminated 4-20 mA cordset, 13 ft / 4 m (longer lengths available by special order)	Consult
Consult	Consult	Set-points output cable, 13 ft / 4 m for access to internal SS relays	Consult
Consult	Consult	Unterminated serial cable for communication port connection, 13 ft / 4 m (longer lengths available by special order)	Consult
Consult	Consult	Prewired load cell cable (various lengths for single and dual channel available)	Consult
Consult	Consult	Second A/D module (4 scale inputs - adds second 12-Pin connector)	Consult
Consult	Consult	CellScale Virtual Monitor (CVM) application software (enables PC to emulate scale indicator., contact factory for assistance)	Consult
Consult	Consult	Modem only equipped version (CellScale A/D removed)	Consult
Consult	Consult	Non-RF equipped version (CellScale RF modem removed)	Consult
Consult	Consult	MSI-9002 breakout/summing box; 4 in /one out or 4 in / two out	Consult
Consult	Consult	MSI-9008 multiplexer; 8 in / one out (expands single channel into 8)	Consult
Consult	Consult	WiFi Ethernet Connectivity (802.11b - contact factory for assistance)	Consult
Consult	Consult	12-Pin mating connector for single or dual scale input	Consult

# MSI-9020 CellScale™ RF CellModem

## Specifications

**Enclosure:**

NEMA 4, IP65 milled anodized aluminum with O-ring gaskets  
 NEMA 6, IP67 with optional long range antenna

**Weight:**

3.5 lb (1.6 kg)

**Annunciators:**

Three LED status lamps for Power, Data TX/RX and Configuration

**Power Input:**

9-30 VDC (Internal 85-265 VAC, 47-440 Hz power supply optional)

**Operating Temperature:**

-4°F to 158°F (-20°C to 70°C)

**Radio Link:**

FHSS at 2.4 GHz (up to 64 network selections)

**Radio Link Effective Range:**

Typically 500 ft (150 m) indoor, 1000 ft (300 m) outdoor with standard antennas.  
 (See optional antennas for longer range)

**Standard Antenna:**

1/2 wave 2dBi, articulated

**RFI/EMI Shielding:**

Exceeds NIST HB44 and CE Standards

**Data I/O:**

One Comm Port with two connector interfaces for RS-232 and RS-422

**Warranty:**

One-year limited

**Approvals:**

NTEP CC 05-077



## Standard Features

- Modem only component; provides serial interface with computers, printers and scoreboards to a CellScale network
- 2.4 GHz spread spectrum frequency hopping
- Power cable, 13 ft (4 m) for 9-30 VDC input
- One communication port; RS-232 or RS-422, 13 ft (4 m) interface cable
- NEMA 4, IP65 enclosure (NEMA 6, IP67 with Long Range Antenna)

## Part Number/Price

PART #	MSI PART #	DESCRIPTION	EST. SHIP WEIGHT	PRICE
138477	502536-0001	MSI-9020 RF CellModem	7 lb (3.5 kg)	\$2,240.00

## Options/Accessories

PART #	MSI PART #	DESCRIPTION	EST. SHIP WEIGHT	PRICE
Consult	Consult	Internal 85-265 VAC, 47-440 Hz power supply	-	\$295.00
143466	12147	Long range antenna, 300 m-500 m omni-directional with 9dBi gain, includes 10 ft / 3 m coaxial cable	1 lb	415.00
Consult	Consult	9dBi or 14dBi gain corner reflector antenna	1 lb	Consult
Consult	Consult	5dBi gain vehicle/cab mount whip antenna, includes 17 ft / 5.2 m coax cable	1 lb	Consult
137567	502046-0001	Unterminated serial cable for communication port connection, 13 ft / 4 m longer lengths available by special order	1 lb	100.00
Consult	Consult	CellScale Virtual Monitor (CVM) application software (enables PC to emulate scale indicator)	Consult	Consult

# MSI Scoreboards Wireless RF

Remote Displays

## Specifications

**Enclosure:**

NEMA 4, IP56 rugged aluminum extruded case with integrated hood

**Display:**

Six-digit long-life LED 4 in or 6 in, and red or green characters available

**Power:**

AC/DC power supply 85-265 VAC, 47-440 Hz/130-300 VDC

**Radio Link:**

Frequency hopping spread spectrum at 2.4 GHz

**Radio Link Effectice Range:**

Typically 500 ft (150 m) indoors, 1000 ft (300 m) outdoors with standard antennas (see optional antennas for longer range)

**Standard Antenna:**

1/2 wave 2 dBi, articulated

**Warranty:**

One-year limited

**Echo Data Output:**

RS-232



## Standard Features

- Long Life LED Technology (100,000 hour), viewable in direct sunlight
- Internal lightning protection
- Swivel mounting bracket (mounts to uneven surfaces and poles)
- Integrated hood
- Maximum decimal displayed 0.000
- Integrated data repeater
- AC/DC power supply: 85-265 VAC, 47-440 Hz/130-300 VDC
- RF Telemetry via 2.4 GHz frequency hopping spread spectrum modem

## Part Number/Price

PART #	MSI PART #	DESCRIPTION	EST. SHIP WEIGHT	PRICE
162899	Consult	Red LED, 4 in (101 mm), six digit display, TranSend Equipped	21lb (10 kg)	\$2,195.00
162900	Consult	Green LED, 4 in (101 mm), six digit display, TranSend Equipped	21lb (10 kg)	2,195.00
162897	Consult	Red LED, 6 in (152 mm), six digit display, TranSend Equipped	37lb (17 kg)	2,650.00
162898	Consult	Green LED, 6 in (152 mm), six digit display, TranSend Equipped	37lb (17 kg)	2,650.00
139056	502855-0006	Red LED, 4 in (101 mm), six digit display, Cell Scale Equipped	21lb (10 kg)	2,950.00
139055	502855-0005	Green LED, 4 in (101 mm), six digit display, Cell Scale Equipped	21lb (10 kg)	3,665.00
139052	502855-0002	Red LED, 6 in (152 mm), six digit display, Cell Scale Equipped	37lb (17 kg)	3,360.00
139051	502855-0001	Green LED, 6 in (152 mm), six digit display, Cell Scale Equipped	37lb (17 kg)	4,075.00

## Options/Accessories

PART #	MSI PART #	DESCRIPTION	EST. SHIP WEIGHT	PRICE
Consult	Consult	12 VDC power input	-	Consult
Consult	Consult	24 VDC power input	-	Consult
Consult	Consult	Long range antenna, 300m-500m omni-directional with 9dBi gain, includes 10 ft / 3 m coaxial cable	1 lb	Consult
Consult	Consult	9dBi gain corner reflector antenna	1 lb	Consult
Consult	Consult	14dBi gain corner reflector antenna	1 lb	Consult
Consult	Consult	5dBi gain vehicle/cab mount whip antenna	1 lb	Consult
Consult	Consult	Non RF equipped configuration (requires hard wired interface)	-	(850.00)

# Shackle Dimensions

## Part Number/Price

PART NUMBER	MSI PART NUMBER	W.L.L. TONS	SIZE	A	B	C	D	E	F	H	L	N	P	WEIGHT
151357	10541	3 1/4	.63	1.06	.75	2.38	.63	1.69	1.56	4.22	2.94	.69	.63	1.58
151355	10538	6 1/2	.88	1.44	1.00	3.31	.88	2.28	2.13	5.75	4.03	.97	5.00	3.95
141992	10539	17	1.50	2.38	1.63	5.75	1.50	3.88	3.63	9.88	6.88	1.62	8.25	19.50
151356	10540	25	1.75	2.88	2.00	7.00	1.75	5.00	4.32	11.88	8.50	2.12	9.59	31.30
146334	23650-0030	30	1.50	2.38	1.63	5.75	1.50	3.88	3.63	9.88	6.88	1.62	8.25	20.80
146335	23650-0040	40	1.75	2.88	2.00	7.00	1.75	5.00	4.32	11.88	8.50	2.12	9.59	33.91
146336	23650-0050	55	2.00	3.25	2.25	7.75	2.00	5.75	5.00	13.38	9.75	2.00	11.00	51.75
83454	N/A	85	2.5	4.12	2.75	10.50	2.72	7.25	5.69	17.84	12.87	3.12	13.58	96.0
151360	23650-0110	110	3.00	5.00	3.25	13.00	3.00	7.88	6.50	21.50	14.50	3.63	16.50	178.00
83455	N/A	120	3	5.00	3.25	13.00	3.11	7.88	6.50	21.50	14.36	3.63	15.13	178.0
151361	23650-0175	175	4.00	5.50	4.25	14.50	4.00	10.00	9.00	25.69	18.38	4.56	19.75	338.00
83458	N/A	250	4	8.50	5.00	20.00	4.50	13.00	12.00	35.00	24.50	6.50	22.68	600.0
<b>Oversized Shackles</b>														
148497	501386-0100	40	1.75	2.88	2.00	10.00	2.25	6.00	4.32	15.35	10.50	2.25	9.00	45.00
148393	501082-0100	40	2.25	2.88	2.00	12.50	2.25	8.00	4.32	17.85	12.50	2.25	10.00	90.00
148394	501083-0100	50	2.00	3.25	2.25	12.25	2.50	8.00	5.00	18.50	13.00	2.50	11.00	72.00
<b>Shims</b>														
146534	30013-0112	(For use with 50K/70K Ton systems)												

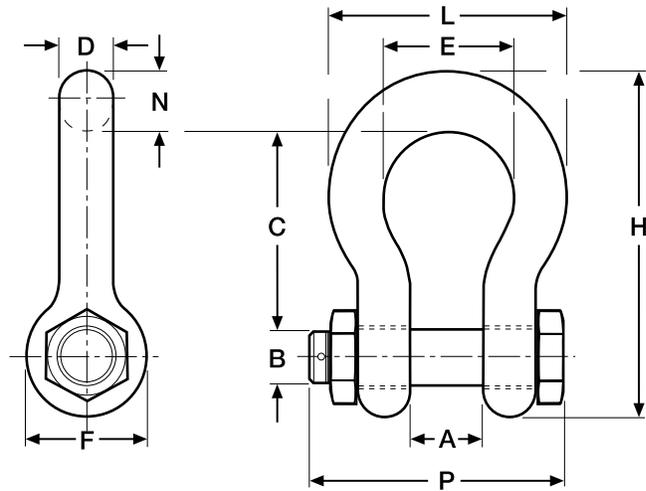



# Intercomp CS™ 200

## Specifications

**Resolution:**

14 bit A/D delivers more than 16,000 internal counts

**Controls:**

Zero, backlight, on/off

**Display:**

0.5 in (12 mm) 4-digit LCD

**Power:**

Standard: one 9V disposable alkaline dry cell, 300 hours

Optional: Rechargeable nickel cadmium cell, 20 hours continuous with backlight

**Enclosure:**

Weatherproof ABS plastic case

**Auto Shut-off:**

Low battery, or after 5 minutes without use

**Accuracy:**

±0.1% of applied load

**Temperature**

Operating +15° F to 122° F (-10° C to 50° C)

**Nominal Overload:**

200% of capacity

**Maximum Overload:**

500% of capacity

**Warranty:**

One-year limited warranty

**Approvals:**

CE



## APPROVALS



## Standard Features

- Lightweight and compact
- Digital calibration
- Auto shut-off
- lb/kg selectable
- Peak hold feature
- Display with backlight

## Part Number/Price

PART #	DESCRIPTION	EST. SHIP WEIGHT	PRICE
<b>CS200 (9-V alkaline battery included):</b>			
43734	CS200, 25 lb (12.5 k-g) x 0.01 lb (0.01 kg)	2 lb	\$595.00
43735	CS200, 50 lb (25 kg) x 0.02 lb (0.01 kg)	2 lb	595.00
43736	CS200, 100 lb (50 kg) x 0.05 lb (0.02 kg)	2 lb	595.00
43737	CS200, 250 lb (125 kg) x 0.1 lb (0.05 kg)	2 lb	595.00
82444	CS200, 500 lb (250 kg) x 0.2 lb (0.1 kg)	2 lb	595.00

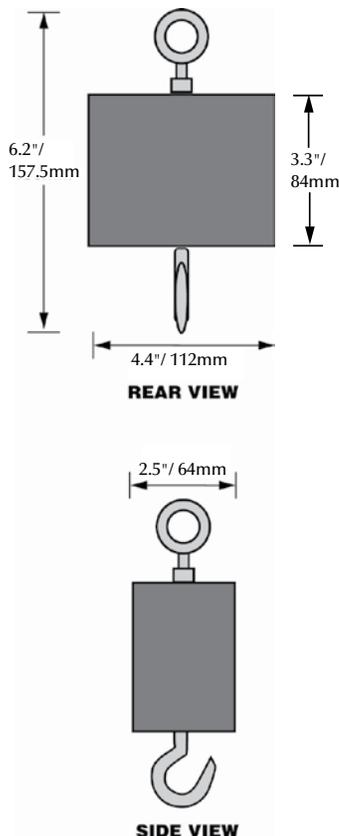

# Intercomp CS™ 750

## Specifications

**Resolution:**

20 bit A/D delivers more than 1 million internal counts

**Controls:**

Automatic backlight, on/off, zero, lb/kg, TARE and Accum/Total

**Display:**

1 in (25 mm) 5-digit LCD

**Indicators:**

lb/kg

**Power:**

Six D size disposable alkaline dry cells, 250 hours of operation, or rechargeable nickel-cadmium batteries 80 hours.

**Dimensions:**

Control box: 8.5 L x 5 W x 4.25 in H  
(216 L x 127 W x 108 mm H)  
Lifting eye to hook: 9.5 in (241 mm)

**Enclosure:**

Weatherproof extruded-aluminum case

**Est. Ship Weight:**

8.5 lb (4 kg)

**Auto Shut-off:**

Low battery, or after twenty minutes without use

**Accuracy:**

±0.1% of reading

**Temperature:**

Operating -4° F to 140° F (-20° C to 60° C)

**Nominal Overload:**

200% of capacity

**Maximum Overload:**

500% of capacity

**Warranty:**

One-year limited warranty

**Approvals:**

NTEP CC 97-135, Class III 3000d  
Measurement Canada AM-5228  
CE



## APPROVALS



Measurement  
Canada  
Approved



## Standard Features

- Digital calibration
- Adjustable, auto shut off
- 1 in LCD digital readout
- Powered by 4 D cell batteries
- Infrared remote control
- Automatic backlight

## Part Number/Price

PART #	DESCRIPTION	EST. SHIP WEIGHT	PRICE
43643	CS750, 100 lb (50 kg) x 0.05 lb (0.02 kg)	9 lb	\$945.00
43644*	CS750, 300 lb (150 kg) x 0.1 lb (0.05 kg)	9 lb	945.00
43645*	CS750, 500 lb (250 kg) x 0.2 lb (0.1 kg)	9 lb	945.00
43646*	CS750, 1,000 lb (500 kg) x 0.5 lb (0.2 kg)	9 lb	945.00

Batteries not included

## Options/Accessories

PART #	DESCRIPTION	PRICE
43939	RS-232 serial output	\$195.00
43941	120/220V external charger (batteries not included) for qty 3 x 3 D-Nicad/NiMH	245.00
97447	Battery pack, qty 2 x 3 "D"-size-Nicad	180.00

\*NTEP and Measurement Canada Certified

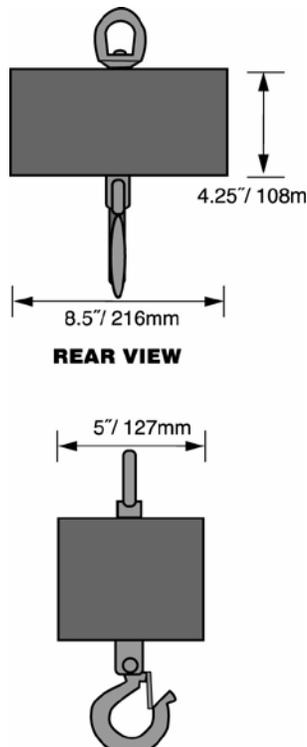

# Intercomp CS™ 1500

## Specifications

### Resolution:

20 bit A/D delivers more than 1 million internal counts

### Controls:

Zero, lb/kg, On, Off, Tare, Print, Mode and Set

### Display:

0.8 in (20 mm) 5 1/2 in LED

### Indicators:

lb/kg, Gross, Net, Total, and Peak Hold

### Power:

8 D size disposable alkaline dry cells, 100 hours or rechargeable nickel-cadmium cells, 30 hours.

*\*Batteries are not included*

### Enclosure:

NEMA 4 cast aluminum case

### Hook or Eye:

Crosby® or equivalent

### Auto Shut-off:

Low battery, or after twenty minutes without use

### Accuracy:

±0.1% of reading

### Temperature:

Operating -4°F to 140°F (-20°C to 60°C)

### Nominal Overload:

200% of capacity

### Maximum Overload:

500% of capacity

### Warranty:

One-year limited warranty

### Approvals:

NTEP CC 97-135, Class III, 3000d; Class IIIIL, 5000d

Measurement Canada AM-5228

CE



## APPROVALS



Measurement  
Canada  
Approved



## Standard Features

- Digital calibration
- Adjustable, auto shut off
- NEMA 4 cast aluminum case
- 0.8 in LED digital readout
- Recessed push-button switch
- Powered by eight D cell batteries\*
- Infrared remote control
- NTEP Certified

## Part Number/Price

PART #	DESCRIPTION	EST. SHIP WEIGHT	PRICE
<b>CS1500 (batteries not included):</b>			
82448*†	CS1500, 500 lb (250 kg) x 0.2 lb (0.1 kg)	22 lb	\$1,595.00
43647*†	CS1500, 1000 lb (500 kg) x 0.5 lb (0.2 kg)	22 lb	1,795.00
43648*†	CS1500, 2000 lb (1000 kg) x 1 lb (0.5 kg)	22 lb	1,795.00
43649*	CS1500, 5000 lb (2500 kg) x 2 lb (1 kg)	38 lb	1,995.00
43650*	CS1500, 10,000 lb (5000 kg) x 5 lb (2 kg)	38 lb	1,995.00
43651*	CS1500, 20,000 lb (10,000 kg) x 10 lb (5 kg)	45 lb	2,895.00

# Intercomp CS™ 1500

## Options/Accessories

PART #	DESCRIPTION	PRICE
110621	RS-232 serial output	\$195.00
43940	120/220V external charger (batteries not included) for quantity 2 x 4 D-Nicad/NiMH	220.00
97445	Battery pack, quantity 2 x 4 D-size-Nicad	240.00

\* NTEP Certified

† Measurement Canada

## Dimensions

PART#	CAPACITY	GRADUATION	A	B	C	D	E	F	WEIGHT
82448	500 lb (250 kg)	0.2 lb (0.1 kg)	10.5 in (267 mm)	2.38 in (61 mm)	2 in (51 mm)	0.97 in (25 mm)	1.38 in (35 mm)	0.84 in (22 mm)	22 lb (10 kg)
43647	1000 lb (500 kg)	0.5 lb (0.2 kg)	10.5 in (267 mm)	2.38 in (61 mm)	2 in (51 mm)	0.97 in (25 mm)	1.38 in (35 mm)	0.84 in (22 mm)	22 lb (10 kg)
43648	2,000 lb (1,000 kg)	1 lb (0.5 kg)	11.5 in (292 mm)	2.38 in (61 mm)	2 in (51 mm)	0.97 in (25 mm)	1.38 in (35 mm)	0.84 in (22 mm)	22 lb (10 kg)
43649	5000 lb (2,500 kg)	2 lb (1 kg)	19 in (482 mm)	2.88 in (73 mm)	2.25 in (57 mm)	1.69 in (43 mm)	2.5 in (64 mm)	1.82 in (46 mm)	38 lb (17 kg)
43650	10,000 lb (5,000 kg)	5 lb (2 kg)	19 in (482 mm)	2.88 in (73 mm)	2.25 in (57 mm)	1.69 in (43 mm)	2.5 in (64 mm)	1.82 in (46 mm)	38 lb (17 kg)
43651	20,000 lb (10,000 kg)	10 lb (5 kg)	23 in (584 mm)	3.5 in (90 mm)	3.12 in (80 mm)	2.41 in (62 mm)	3.25 in (83 mm)	2.6 in (66 mm)	45 lb (20 kg)

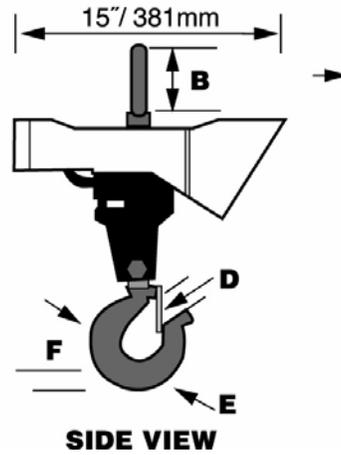
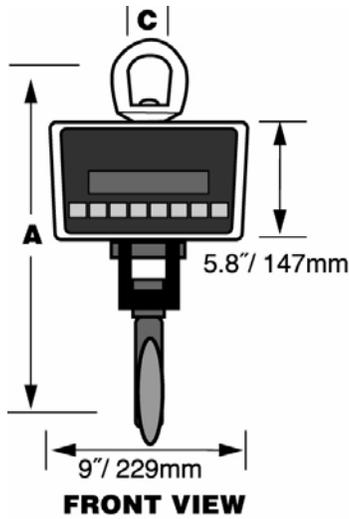

# Intercomp CS™ 3000-RFX

## Specifications

**Resolution:**

20 bit A/D delivers more than 1 million internal counts

**Controls:**

Zero, lb/kg, Tare, Mode, Accum Total, On/Off

**Display:**

1 in (25 mm) 5-digit liquid crystal (LCD)

**Status Annunciators:**

lb/kg, Net, Gross, Total, Tare, Low Battery

**Power:**

8 D size disposable alkaline dry cell or rechargeable nickel-cadmium cell.  
*\*\*Batteries are not included*

**Battery Life:**

8 D cell alkalines (not included) 3000 hours  
8 NiCad rechargeable batteries  
(sold as an option) 900 hours

**Tare:**

Up to 100% of capacity

**Enclosure:**

NEMA 4 cast aluminum case

**Hook or Eye:**

Crosby® or equivalent

**Accuracy:**

±0.1% of reading

**Temperature:**

Operating -4°F to 140°F (-20°C to 60°C)

**Nominal Overload:**

200% of capacity

**Maximum Overload:**

500% of capacity

**Warranty:**

One-year limited warranty

**Approvals:**

NTEP CC 97-135, Class III, 3000d; Class III, 5000d  
CE

Up To  
**3000 HOURS**  
of Battery Life



## APPROVALS



## Standard Features

**Scale:**

- Auto shut-off, configurable from 0 to 255 minutes
- NEMA 4 cast aluminum case
- 1 inch LCD digital readout with auto backlight
- Powered by eight D cell batteries\*\*
- RFX Wireless Hand Held Indicator: Rugged ABS Industrial Housing
- Four line, 5-digit, 0.5 in LCD digital readout
- Indicator carrying case with charger and 4 AA NiMH rechargeable batteries
- 40 hours of continuous use (with backlight off)
- Ability to turn the hanging unit on or off

# Intercomp CS™ 3000-RFX

## Part Number/Price

PART #	DESCRIPTION	EST. SHIP WEIGHT	PRICE
<b>CS3000 (batteries not included):</b>			
118816*	CS3000-RFX, 2,000 lb (1,000 kg) x 1.0 lb (0.5 kg)	52 lb	\$3,795.00
118817*	CS3000-RFX, 5,000 lb (2,500 kg) x 1.0 lb (0.5 kg)	60 lb	3,895.00
118818*	CS3000-RFX, 10,000 lb (5,000 kg) x 2 lb (1 kg)	60 lb	3,995.00
118819*	CS3000-RFX, 20,000 lb (10,000 kg) x 5 lb (2 kg)	100 lb	5,995.00
118820*	CS3000-RFX, 30,000 lb (15,000 kg) x 10 lb (5 kg)	125 lb	6,495.00
118821*	CS3000-RFX, 50,000 lb (25,000 kg) x 10 lb (5 kg)	225 lb	9,895.00
118822*	CS3000-RFX, 70,000 lb (35,000 kg) x 20 lb (10 kg)	253 lb	13,495.00
118823	CS3000-RFX, 100,000 lb (50,000 kg) x 20 lb (10 kg)	397 lb	17,495.00

## Options/Accessories

PART #	DESCRIPTION	PRICE
43940	120/220V external charger (batteries not included) for qty 2x4 D-Nicad/NiMH	\$220.00
97445	Battery pack, qty 2 x 4 D-size-Nicad	240.00

\* NTEP Certified

## Dimensions

PART#	CAPACITY	GRADUATION	A	B	C	D	*	HOOK	EYE NUT OR SHACKLE
118816	2000 lb (1000 kg)	1.0 lb(0.5 kg)	19.3 in (490 mm)	3.06 in (77.7 mm)	1.44 in (35.1 mm)	1.41 in (35.8 mm)	*	C/L 3 ton S1 Swivel	C/L #7 Eye Nut
118817	5000 lb (2500 kg)	1.0 lb(0.5 kg)	22 in (558 mm)	3.06 in (77.7 mm)	1.82 in (44.5 mm)	1.69 in (42.9 mm)	*	C/L 5 ton S1 Swivel	C/L #7 Eye Nut
118818	10000 lb (5000 kg)	2 lb(1 kg)	22 in (558 mm)	3.06 in (77.7 mm)	1.82 in (44.5 mm)	1.69 in (42.9 mm)	*	C/L 5 ton S1 Swivel	C/L #7 Eye Nut
118819	20000 lb (10000 kg)	5 lb(2 kg)	37.15 in (944 mm)	6.25 in (159 mm)	2.6 in (65.8 mm)	2.41 in (61.2 mm)	*	C/L 10 ton S1 Swivel	C/L #11 Eye Nut
118820	30000 lb (15000 kg)	10 lb(5 kg)	39.15 in (994 mm)	6.25 in (159 mm)	3 in (76.2 mm)	3.19 in (81.3 mm)	*	C/L 15 ton S1 Swivel	C/L #11 Eye Nut
118821	†50000 lb (†25000 kg)	10 lb(5 kg)	43.5 in (1105 mm)	6 in (152 mm)	3.6 in (93 mm)	3.62 in (92 mm)	17 in (432 mm)	C/L 25 ton S1 Swivel	C/L 30 ton #2140
118822	†70000 lb (†35000 kg)	20 lb(10 kg)	47.56 in (1208 mm)	6 in (152 mm)	4.56 in (116 mm)	3.75 in (92.3 mm)	17 in (432 mm)	C/L 35 ton S1 Swivel	C/L 40 ton #2140
118823	†100000 lb (†50000 kg)	20 lb(10 kg)	53 in (1347 mm)	7.75 in (197 mm)	5.06 in (129 mm)	4.25 in (108 mm)	18 in (457 mm)	C/L 45 ton S1 Swivel	C/L 50 ton #2140

\* Dimensions are top to bottom shackle eye to eye on 25-50 ton/12.5-25 metric ton capacity models

†Unit comes standard with top shackle & bottom swivel hook.

\*\*Batteries are not included

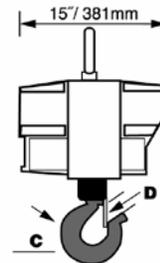
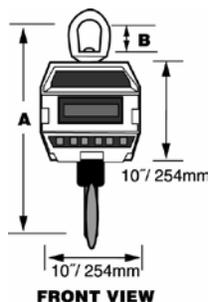

# Intercomp TL 8500

## Specifications

### Construction:

Aluminum construction for 10,000 lb and below capacities  
Stainless steel construction above 10,000 lb capacities

### Accuracy:

+/- 0.1% of applied load or +/-1 graduation; whichever is greater (500 - 10,000 lb)  
+/- 0.2% or +/-2 graduations for 25,000-160,000 lb  
+/- 0.25% or +/- 2 graduations for 220,000 lb and higher

### Display:

Five digit, 1.2 in (30 mm) high LCD

### Control Keys:

On/Off, Zero (100%), Tare (100%), Peak Hold and Mode

### Annunciator:

Low Battery, Peak Hold, Set Points 1 & 2, lb, kg, tons, metric tons and dekaNewtons

### Power:

Two (9V) batteries (batteries included)

### Operating Time:

Up to 300 hours of continuous use. Wireless remote control models have reduced operating time of 50 hours.

### Operating Temperature:

-4°F to 140°F (-20°C to 60°C)

### Enclosure:

NEMA 4X/IP 65

### Overload:

200% safe, 500% ultimate

### Calibration:

Digital keypad, multi-point

### Output:

RS-232 and RS-485 optional

### Warranty:

One-year limited warranty



## Standard Features

- Aluminum or stainless steel construction
- Peak hold feature
- Self-contained display
- Wireless output standard on all models

## Part Number/Price

PART #	DESCRIPTION	EST. SHIP WEIGHT	PRICE
157013	500 x 0.5 lb (250 x 0.2 kg), wireless RF	3 lb	\$1,295.00
157014	1000 x 1 lb (500 x 0.5 kg), wireless RF	3 lb	1,295.00
157015	2000 x 2 lb (1000 x 1 kg), wireless RF	3 lb	1,295.00
157016	5000 x 5 lb (2500 x 2 kg), wireless RF	3 lb	1,395.00
157017	10,000 x 10 lb (5000 x 5 kg), wireless RF	6 lb	1,395.00
157018	25,000 x 20 lb (12,500 x 10 kg), wireless RF	26 lb	1,895.00
157019	50,000 x 50 lb (25,000 x 20 kg), wireless RF	30 lb	2,395.00

Note: A single remote can control up to four TL8500 tension links

## Options/Accessories

PART #	DESCRIPTION	PRICE
83449	500-5,000 lb (3.25 Ton) shackle (pair G-2130)	\$99.00
83450	10,000 (6.5 Ton) shackle (pair G-2130)	195.00
83451	34,000 (17 Ton) shackle (pair G-2130)	605.00
83452	50,000 (25 Ton) shackle (pair G-2130)	895.00
157023	TL 8500 RF remote indicator	995.00

# Intercomp TL 8500

## Dimensions

PART#	CAPACITY	RESOLUTION	A	B	C	D	E	F	G	SHACKLE TYPE/CAPACITY
82490	500 lb (250 kg)	0.5 lb (0.2 kg)	13 in (304 mm)	0.81 in (21 mm)	7.42 in (178 mm)	1 in (25 mm)	1.69 in (43 mm)	2 in (51 mm)	4.75 in (121 mm)	G-2130-3 1/4 Ton
82491	1000 lb (500 kg)	1 lb (0.5 kg)	13 in (304 mm)	0.81 in (21 mm)	7.42 in (178 mm)	1 in (25 mm)	1.69 in (43 mm)	2 in (51 mm)	4.75 in (121 mm)	G-2130-3 1/4 Ton
82492	2,000 lb (1,000 kg)	2.0 lb (1 kg)	13 in (304 mm)	0.81 in (21 mm)	7.42 in (178 mm)	1 in (25 mm)	1.69 in (43 mm)	2 in (51 mm)	4.75 in (121 mm)	G-2130-3 1/4 Ton
82493	5,000 lb (2,500 kg)	5 lb (2 kg)	13 in (304 mm)	0.81 in (21 mm)	7.42 in (178 mm)	1 in (25 mm)	1.69 in (43 mm)	2 in (51 mm)	4.75 in (121 mm)	G-2130-3 1/4 Ton
82494	10,000 lb (5,000 kg)	10 lb (5 kg)	15.22 in (386 mm)	1.06 in (27 mm)	7.6 in (193 mm)	1.4 in (36 mm)	2.28 in (58 mm)	2.77 in (56 mm)	5 in (127 mm)	G-2130-6 1/2 Ton
82495	25,000 lb (12,500 kg)	20 lb (10 kg)	20.9 in (530 mm)	1.69 in (43 mm)	8.7 in (212 mm)	2.13 in (54 mm)	3.63 in (92 mm)	4.3 in (109 mm)	5 in (127 mm)	G-2130-17 Ton
82496	50,000 lb (25,000 kg)	50 lb (20 kg)	24.7 in (627 mm)	2.06 in (52 mm)	9.2 in (234 mm)	2.44 in (62 mm)	5 in (127 mm)	5.93 in (151 mm)	5 in (127 mm)	G-2130-25 Ton

NOTE: 160,000 lb and higher only display in Tons

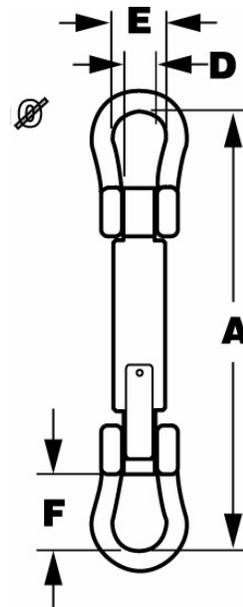
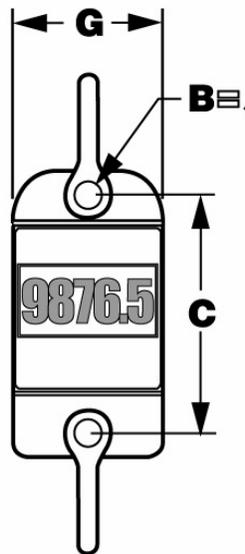



# Dimensioning

Table of Contents

**iDimension™ 200/300 Series**..... **252**  
3D Imaging System

**ESPAÑOL** | Visit [ricelake.com/spanish](http://ricelake.com/spanish)  
to see all RLWS materials  
available in Spanish

Product names, logos, brands, and other trademarks featured  
or referred to within this publication are the property of their respective trademark holders.

# iDimension™ 200/300 Series

## 3D Imaging System

iDimension 200 is designed for use on tabletops or work stations in retail, office and shipping environments.

iDimension 300 is designed to be securely installed to a concrete floor and positioned over a workstation or roller/conveyor system in warehouse and manufacturing environments.

- Interface directly with iDimension via a PC Ethernet connection and web service based operator and user display.

### Standard Features

- Calculates dimensions in less than 0.5 seconds
- Instantly captures dimensions, weight, barcodes, OCR text and image of static items
- Dimensions packages, flats and irregular objects
- Converts irregular objects like cylinders, spheres, tubes, polybags and uneven objects to accurate cubed dimensions
- No moving parts
- Requires virtually no alignment or special handling while placing the object under the work area
- Automatic or Manual operating modes
  - Manual Mode: Initiate dimension of item via barcode scan or software function key
  - Automatic Mode: Initiate dimension via detection of object in work area
- Interfaces with most shipping scales and select Rice Lake indicators
- Quick assembly: Includes necessary tools
- Easy to set up and calibrate: Includes calibration object and embedded web service interface via a fixed IP or DHCP

### Part Numbers/Price

PART #	DESCRIPTION	EST. SHIP WEIGHT	PRICE
165600	iDimension 200		Consult
165601	iDimension 300		Consult

### Options/Accessories

PART #	DESCRIPTION	PRICE
165604	Yearly embedded software maintenance fee	\$600.00



200 Series



300 Series

### Specifications

#### Physical Dimensions 200 Series:

Length: 25.5 in (65 cm)  
 Width: 14 in (36 cm)  
 Height: 67 in (170 cm)  
 Weight: 28 lb (13 kg)

#### Physical Dimensions 300 Series:

Depth: 30 in (76 cm)  
 Width: 34 in (86 cm)  
 Height: 79 in (200 cm)

#### Measurement Range, Legal for Trade 200 Series:

Max. Size: (L x W x H) 48 x 28 x 28 in (1200 x 700 x 700 mm)  
 Min. Size: (L x W x H) 5.5 x 5.5 x 3 in (140 x 140 x 60 mm)  
 Measurement Increment: 0.25 in (5 mm)

*Note: for Non Legal for Trade applications, the minimum size object is 4.7 x 3.4 x 0.5 in*

#### Measurement Range, Legal for Trade 300 Series:

Max. Size: (L x W x H) 48 x 32 x 32 in (1200 x 800 x 800 mm)  
 Min. Size: (L x W x H) 7 x 7 x 3 in (178 x 178 x 76 mm)  
 Measurement Increment: 0.25 in (5 mm)

#### Object Types:

Legal For Trade: Cuboid  
 Non Legal For Trade: Cuboid, irregular shapes

#### Power Requirements 200 Series:

Single power source 110-240V external power supply

#### Power Requirements 300 Series:

Single power source 110-240V power cord cable with 3 conductor PC, power connector socket

#### Operating Temperature:

41° F to 104° F (5° C to 40° C)

#### Humidity:

Non-condensing

#### Mechanical Environment Class:

M1

#### Electromagnetic Class:

E1

#### I/O Ports:

(3) USB type A ports  
 (1) 10/100/100BASE-T Ethernet port

#### Bar Codes Supported:

EAN13, UPC A and 2/5 digit extensions, Code 128 and UCC/EAN-128 encoding, Code 39, Code 93, EAN 8, UPC – E, UPC 2/5 digit extensions, Interleaved 2 of 5, Codabar, Patch Codes, PDF 417, Datamatrix, QRCode

#### Software Maintenance Updates:

Continuous embedded software maintenance updates required. Includes 2 years of software maintenance fee at no charge.

#### Warranty:

One-year limited warranty

#### Approval:

NTEP Pending

# Floor Scales

## Table of Contents

<b>RoughDeck® Rough-n-Ready System</b> .....	<b>254</b>	<b>Bumper Guards</b> .....	<b>288</b>
Floor Scale/Indicator Package		Option A	
<b>RoughDeck® and iQUBE 2®</b>		<b>Bumper Guards</b> .....	<b>289</b>
<b>Rough-n-Ready System</b> .....	<b>256</b>	Option B	
<b>RoughDeck® HP</b> .....	<b>258</b>	<b>Bumper Guards</b> .....	<b>290</b>
High Performance Structural Steel Low-Profile Floor Scale		Option C	
<b>RoughDeck® HP-H</b> .....	<b>260</b>	<b>RoughDeck® HP and SS</b> .....	<b>291</b>
Heavy Capacity Floor Scale		Portability Frames	
<b>RoughDeck® CS</b> .....	<b>262</b>	<b>RoughDeck® HP Caster</b> .....	<b>292</b>
Coil Scale		Portability Frames	
<b>RoughDeck® SS</b> .....	<b>264</b>	<b>RoughDeck® HP, SS &amp; HE</b> .....	<b>293</b>
Stainless Steel Low-Profile Floor Scale		Pit Frame Concrete Details*	
<b>RoughDeck® HE</b> .....	<b>265</b>	<b>RoughDeck® HP-H</b> .....	<b>294</b>
Hostile Environment Stainless Steel Low-Profile Floor Scale		Pit Frame Concrete Details* – 20,000lb Capacity	
<b>AutoLift HE</b> .....	<b>266</b>	<b>RoughDeck® HP-H</b> .....	<b>295</b>
Hostile Environment Stainless Steel Low-Profile Lift Floor Scale		Pit Frame Concrete Details* – 30,000lb Capacity	
<b>RoughDeck® QC</b> .....	<b>268</b>	<b>AutoLift HE</b> .....	<b>296</b>
Quick Clean Stainless Steel Floor Scale		Pit Frame Concrete Details*	
<b>RoughDeck® SD</b> .....	<b>270</b>	<b>RoughDeck® QC</b> .....	<b>297</b>
Sanitary Deck Floor Scale		Pit Frame Concrete Details*	
<b>RoughDeck® BDP</b> .....	<b>272</b>	<b>Summit® 3000</b> .....	<b>298</b>
Barrel Scale – Standard Model		Pit Frame Concrete Details*	
<b>RoughDeck® BDP</b> .....	<b>274</b>		
Barrel Scale – Standard Model with Portability Option			
<b>DeckHand Rough-n-Ready System</b> .....	<b>276</b>		
Portable Scale			
<b>DeckHand</b> .....	<b>277</b>		
Portable Scale			
<b>RL1200</b> .....	<b>278</b>		
Portable Beam Scale			
<b>RL1200 EM</b> .....	<b>279</b>		
Electromechanical Portable Beam Scale			
<b>RoughDeck® FXB</b> .....	<b>280</b>		
Flexure Lever Floor Scale			
<b>Floor Scale and Indicator Package</b> .....	<b>282</b>		
<b>Summit® 3000</b> .....	<b>284</b>		
Low-Profile Floor Scale			
<b>Floor Scale</b> .....	<b>286</b>		
Access Ramps			
<b>Floor Scale</b> .....	<b>287</b>		
Pit Frames			

**ESPAÑOL** | Visit [ricelake.com/spanish](http://ricelake.com/spanish) to see all RLWS materials available in Spanish

The following product names, logos, brands, and other trademarks featured or referred to within this publication are the property of their respective trademark holders.

# RoughDeck® Rough-n-Ready System

Floor Scale/Indicator Package

## Specifications

### RoughDeck Approvals:

NTEP CC 92-001 Class III 5,000d

Measurement Canada AM-4827, Class III 5,000d

### 420 Plus Approvals:

NTEP CC 04-076 Class III/IIIL 10,000d

Measurement Canada, AM-5554, Class III/IIILD

OIML approval at 10,000 divisions, TC7004

UL & CUL listed

CE marked

### IQ plus® 390-DC Approvals:

NTEP CC 98-203, Class III/IIIL 10,000d

Measurement Canada Approved AM-5300

Class III/IIILD, III 10,000d and IIIHD at 20,000d

CE marked

UL & CUL listed

### IQ plus® 590-DC Approvals:

NTEP CC 98-203, Class III/IIIL, 10,000d

Measurement Canada approved, AM-5300,

Class III, 10,000d Class IIIHD 20,000d

CE marked,

UL & C-UL listed

### 480 Legend Approvals:

Measurement Canada AM-5892,

Accuracy Class III/IIILD, 10 000d

NTEP CC 12-123,

Accuracy Class III/IIIL, 10 000d

OIML R76/2006-NL1-12.48, T5692, TC8322

Accuracy Class III, 10 000d

CE Marked

UL Marked

### 482/482 Plus Legend Approvals:

Measurement Canada AM-5892,

Accuracy Class III/IIILD, 10 000d

NTEP CC 12-123,

Accuracy Class III/IIIL, 10 000d

OIML R76/2006-NL1-12.48, T5692, TC8322

Accuracy Class III, 10 000d

CE Marked



Shown with optional floor stand for indicator. Setup and calibration are done at Rice Lake Weighing Systems.

## Standard Features

- Package includes: RoughDeck HP 4 ft x 4 ft x 3.5 in floor scale, 20 ft of hostile environment load cell cable, quick disconnect and indicator
- Package configured and calibrated for 5,000 divisions
- Warranty: RoughDeck HP weldment five years, load cells and indicators two years, all other components one year

Refer to Floor Scale and indicator section of catalog for complete specifications

# RoughDeck® Rough-n-Ready System

Floor Scale/Indicator Package

## Part Number/Price

PART#	FLOOR SCALE CAPACITY	INDICATOR	EST. SHIP WEIGHT	PRICE
<b>115 VAC - 4 ft x 4 ft RoughDeck Indicator Package with Tilt Stand</b>				
53423	5,000 lb	IQ plus® 590	405 lb	\$2,225.00
53424	5,000 lb	IQ plus 390	405 lb	2,225.00
87153	5,000 lb	420 Plus	405 lb	2,225.00
155666	5,000 lb	480	405 lb	2,035.00
168140	5,000 lb	480 Plus	405 lb	2,035.00
168146	5,000 lb	482	405 lb	2,135.00
168152	5,000 lb	482 Plus	405 lb	2,135.00
168159	5,000 lb	482 with internal battery	405 lb	2,335.00
168165	5,000 lb	482 Plus with internal battery	405 lb	2,335.00
53420	10,000 lb	IQ plus 590	405 lb	2,225.00
53421	10,000 lb	IQ plus 390	405 lb	2,225.00
87155	10,000 lb	420 Plus	405 lb	2,225.00
155667	10,000 lb	480	405 lb	2,035.00
168141	10,000 lb	480 Plus	405 lb	2,035.00
168147	10,000 lb	482	405 lb	2,135.00
168153	10,000 lb	482 Plus	405 lb	2,135.00
168160	10,000 lb	482 with internal battery	405 lb	2,335.00
168166	10,000 lb	482 Plus with internal battery	405 lb	2,335.00
<b>230 VAC - 4 ft x 4 ft RoughDeck Indicator Package with Tilt Stand</b>				
53429	5,000 lb	IQ plus 590	405 lb	2,225.00
53430	5,000 lb	IQ plus 390	405 lb	2,225.00
87154	5,000 lb	420 Plus	405 lb	2,225.00
155962	5,000 lb	480	405 lb	2,035.00
168142	5,000 lb	480 Plus	405 lb	2,035.00
168148	5,000 lb	482	405 lb	2,135.00
168154	5,000 lb	482 Plus	405 lb	2,135.00
168161	5,000 lb	482 with internal battery	405 lb	2,335.00
168167	5,000 lb	482 Plus with internal battery	405 lb	2,335.00
53426	10,000 lb	IQ plus 590	405 lb	2,225.00
53427	10,000 lb	IQ plus 390	405 lb	2,225.00
87156	10,000 lb	420 Plus	405 lb	2,225.00
155963	10,000 lb	480	405 lb	2,035.00
168143	10,000 lb	480 Plus	405 lb	2,035.00
168149	10,000 lb	482	405 lb	2,135.00
168155	10,000 lb	482 Plus	405 lb	2,135.00
168162	10,000 lb	482 with internal battery	405 lb	2,335.00
168168	10,000 lb	482 Plus with internal battery	405 lb	2,335.00

## Part Number/Price

PART#	FLOOR SCALE CAPACITY	INDICATOR	EST. SHIP WEIGHT	PRICE
<b>115 VAC 4 ft x 4 ft RoughDeck Canadian Weights &amp; Measures Approved Indicator with Tilt Stand</b>				
94693	2,500 kg	IQ plus 590	405 lb	\$2,225.00
94694	2,500 kg	IQ plus 390	405 lb	2,225.00
94695	2,500 kg	420 Plus	405 lb	2,225.00
155668	2,500 kg	480	405 lb	2,035.00
168144	2,500 kg	480 Plus	405 lb	2,035.00
168150	2,500 kg	482	405 lb	2,135.00
168156	2,500 kg	482 Plus	405 lb	2,135.00
168163	2,500 kg	482 with internal battery	405 lb	2,335.00
168169	2,500 kg	482 Plus with internal battery	405 lb	2,335.00
96497	5,000 kg	IQ plus® 590	405 lb	2,225.00
96498	5,000 kg	IQ plus 390	405 lb	2,225.00
96499	5,000 kg	420 Plus	405 lb	2,225.00
155669	5,000 kg	480	405 lb	2,035.00
168145	5,000 kg	480 Plus	405 lb	2,035.00
168151	5,000 kg	482	405 lb	2,135.00
168157	5,000 kg	482 Plus	405 lb	2,135.00
168164	5,000 kg	482 with internal battery	405 lb	2,335.00
168170	5,000 kg	482 Plus with internal battery	405 lb	2,335.00

## Options/Accessories

PART #	DESCRIPTION	PRICE
18777	Floor anchor plates, mild steel (set of two)	\$30.00
19352	RoughDeck floor stand for indicator, 36.3 in high, mild steel	205.00
126384	RoughDeck floor stand for indicator, 48 in high, mild steel	225.00
77925	Revolution® Scaleware software	35.00

Access ramps, pit frames, bumper guards and portability frames available, see end of section for details

# RoughDeck® and iQUBE 2® Rough-n-Ready System

## Specifications

### End Load Capacity:

200% full scale at 1,000 lb  
100% full scale at 2,000 lb and 5,000 lb  
80% full scale at 10,000 lb

### Cable Length:

10 ft from floor scale to iQUBE<sup>2</sup>  
10 ft serial cable from iQUBE<sup>2</sup> to PC

### Enclosure:

NEMA 4X FRP, 8 x 10 in

### Threaded Eyebolt:

Hole (1/2-20NF) located in center of deck for easy lifting

### Voltage Input:

115/230V AC power supply

### A/D Sampling Rate:

2.5-500 Hz (selectable)

### Minimum System Requirements:

Windows® XP™ or greater  
Internet Explorer 6.0 SP1  
.NET Framework 1.1  
128 MB Ram  
30 MB free hard drive space  
Serial port for connection to iQUBE  
Additional serial ports are required for connections to printers/remote displays

### Status Annunciators:

Units (lb, kg, short tons (tn), metric tons (t), NONE) Gross/Net, Motion, Center of Zero

### Temperature Range:

14°F to 104°F (-10°C to 40°C)

### Warranty (limited):

RoughDeck HP weldment five years, load cells and iQUBE<sup>2</sup> two years, all other components one year

### Approvals:

RoughDeck: NTEP CC 92-001, Class III 5000d  
i QUBE<sup>2</sup>: NTEP 03-032A1, UL E151461, and CE  
VIRTUI2: NTEP CC 04-058 Classes III and IIIL at 10,000 d



## Standard Features:

- Heavy-duty industrial design containing four NTEP Certified alloy steel, shear beam load cells
- Rugged diamond-deck safety treadplate
- Four adjustable stainless steel SUREFOOT™ support feet
- Four corner overload stops
- Remote iQUBE<sup>2</sup> four-channel junction box with power supply
- Diagnostic routines for weighing errors and configurable error reporting
- Cell tests for overloaded, underloaded, zero reference, drift, noise, and unbalanced conditions
- Onboard status LEDs for communications and visual bi-color indication of cell health
- Cell emulator compensates for load cell failure until a repair can be made
- Cal-Match® algorithm automatically trims and calibrates the scale in one pass of test weights
- Standard communication RS-232
- Web browser-based scale monitoring
- Configurable display options
- Virtual front panel consists of display and five button keypad (zero, units, point, tare, gross/net)
- Printer port for output-only, simplex communications
- Two print formats
- Peak weight history
- Recalibration notification

# RoughDeck® and iQUBE 2® Rough-n-Ready System

## Part Number/Price

PART #	SIZE (W X L X H)	CAPACITY	EST. SHIP WEIGHT	PRICE
155626	4 ft x 4 ft x 3.5 in	1,000 lb	390 lb	\$2,610.00
155628	4 ft x 4 ft x 3.5 in	2,000 lb	390 lb	2,610.00
155629	4 ft x 4 ft x 3.5 in	5,000 lb	390 lb	2,610.00
155630	4 ft x 4 ft x 3.5 in	10,000 lb	390 lb	2,610.00
155631	5 ft x 5 ft x 3.5 in	5,000 lb	556 lb	2,940.00
155632	5 ft x 5 ft x 3.5 in	10,000 lb	711 lb	3,300.00

## Options/Accessories

PART #	DESCRIPTION	PRICE
18777	Floor anchor plates, mild steel (set of two)	\$30.00
77142	Ethernet TCP/IP	400.00
108671	Wireless LAN 802.11 B/G	570.00
93245	USB Port	160.00

Access ramps, pit frames, bumper guards and portability frames available, see end of section for details

# RoughDeck® HP

High Performance Structural Steel Low-Profile Floor Scale

## Specifications

### End Load Capacity:

200% full scale at 1,000 lbs  
100% full scale at 2,000 lbs,  
& 5,000 lbs  
80% full scale at 10,000 lbs

### Cable Length:

20 ft (6.1 m) for connecting junction box to indicator

### Threaded Eyebolt:

Hole (1/2-20NF) located in center of deck for easy lifting

### Warranty (limited):

RoughDeck HP weldment five years, load cells two years, all other components one year

### Approvals:

NTEP CC 92-001, Class III 5000d  
Measurement Canada AM-4827, Class III 5,000d

## Standard Features

- Heavy-duty industrial design
- Structural steel channel frame
- Four NTEP Certified alloy steel, shear beam load cells
- 20 ft SURVIVOR® EL147HE hostile environment load cell cable
- TuffSeal® JB4SS stainless steel, NEMA 4X junction box with signal trim card
- Side-access junction box
- Rugged diamond deck safety treadplate
- Four adjustable stainless steel SUREFOOT™ support feet
- Four corner overload stops (Canadian versions only)
- Level bubble (Canadian versions only)



## APPROVALS



Measurement  
Canada  
Approved





# RoughDeck® HP

High Performance Structural Steel Low-Profile Floor Scale

## Part Number/Price

PART #	PART #	SIZE (W X L X H)	CAPACITY	EST. SHIP WEIGHT	PRICE
<b>with Quick Connector</b>	<b>with out Quick Connector</b>				
66318†	67695	2.5 ft x 2.5 ft x 3.5 in	2,000 lb	173 lb	\$1,510.00
66320†	67693	3 ft x 3 ft x 3.5 in	1,000 lb	232 lb	1,510.00
66317†	67696	3 ft x 3 ft x 3.5 in	2,000 lb	232 lb	1,510.00
105300†	105301	3 ft x 3 ft x 3.5 in	5,000 lb	232 lb	1,510.00
66319	67694	4 ft x 4 ft x 3.5 in	1,000 lb	375 lb	1,610.00
67618	67697	4 ft x 4 ft x 3.5 in	2,000 lb	375 lb	1,610.00
66316	67698	4 ft x 4 ft x 3.5 in	5,000 lb	375 lb	1,610.00
66315	67699	4 ft x 4 ft x 3.5 in	10,000 lb	375 lb	1,610.00
66314	67700	4 ft x 5 ft x 3.5 in	5,000 lb	437 lb	1,760.00
66313	67701	4 ft x 5 ft x 3.5 in	10,000 lb	567 lb	2,060.00
66312	67702	4 ft x 6 ft x 3.5 in	5,000 lb	510 lb	1,910.00
66311	67703	4 ft x 6 ft x 3.5 in	10,000 lb	656 lb	2,250.00
66310	67704	5 ft x 5 ft x 3.5 in	5,000 lb	541 lb	1,940.00
66309	67705	5 ft x 5 ft x 3.5 in	10,000 lb	696 lb	2,300.00
66308	67706	5 ft x 6 ft x 3.5 in	5,000 lb	646 lb	2,130.00
66307	67707	5 ft x 6 ft x 3.5 in	10,000 lb	821 lb	2,530.00
66306	67708	5 ft x 7 ft x 3.5 in	5,000 lb	734 lb	2,310.00
66305	67709	5 ft x 7 ft x 3.5 in	10,000 lb	929 lb	2,760.00
<b>Canadian Weights and Measures Approved</b>					
66464†	67710	3 ft x 3 ft x 3.5 in	1,000 kg	232 lb	1,510.00
66465	67711	4 ft x 4 ft x 3.5 in	2,500 kg	375 lb	1,610.00
66466	67712	4 ft x 4 ft x 3.5 in	5,000 kg	375 lb	1,610.00
66467	67713	5 ft x 5 ft x 3.5 in	2,500 kg	541 lb	1,940.00
66468	67714	5 ft x 5 ft x 3.5 in	5,000 kg	696 lb	2,300.00
66469	67715	5 ft x 7 ft x 3.5 in	2,500 kg	934 lb	2,210.00
66470	67716	5 ft x 7 ft x 3.5 in	5,000 kg	929 lb	2,760.00

† Not recommended for use with pallet jacks

\* Includes four corner overload stops and level bubble

## Options/Accessories

PART #	DESCRIPTION	PRICE
N/A	Smooth deck instead of diamond safety tread plate	N/C
18777	Floor anchor plates, mild steel (set of two)	\$30.00
Consult	Four drilled deck holes for scale height adjustment	40.00
19352	RoughDeck floor stand for indicator, 36.3 in high, mild steel	205.00
126384	RoughDeck floor stand for indicator, 48 in high, mild steel	225.00
N/A	Mild steel deck with RL35023S stainless steel (FM approved) load cells, and hardware	+300.00 list price adder
N/A	Mild steel deck with RLH35 welded seal IP67 stainless steel (FM approved) load cells and hardware	+500.00 list price adder
N/A	Mild steel deck with RL35082 welded seal IP66/68 stainless steel (FM approved) load cells and hardware	+800.00 list price adder
N/A	Epoxy paint	+90.00 list price adder
N/A	Top access junction box	+100.00 list price adder
N/A	Forklift channel option (up to 5 ft x 7 ft 10K, accommodates fork tines no larger than 5 in W and 2 in H, fork entry is on opposite side of junction box location)	+275.00 list price adder

Access ramps, pit frames, bumper guards and portability frames available, see end of section for details

# RoughDeck® HP-H

Heavy Capacity Floor Scale

## Specifications

### End Load Capacity:

100% full scale at 20,000 lbs  
66% full scale at 30,000 lbs

### Cable Length:

20 ft (6.1 m) for connecting junction box to indicator

### Threaded Eyebolt:

Hole (3/4-10NC) located in center of deck for easy lifting

### Warranty:

RoughDeck HP-H weldment five years, load cells two years, all other components one year

### Approvals:

NTEP CC 92-001, Class III, 5,000d  
Measurement Canada AM-5284 (Only capacities greater than 10,000 kg)

## Standard Features

- Heavy duty industrial design
- Structural steel channel frame
- Four NTEP Certified alloy steel, shear beam load cells
- 20 ft SURVIVOR® EL147HE hostile environment load cell cable
- TuffSeal® JB4SS stainless steel, NEMA 4X junction box with
- Signal trim card
- Side-access junction box
- Rugged diamond safety treadplate deck
- Four adjustable mild steel SUREFOOT™ support feet

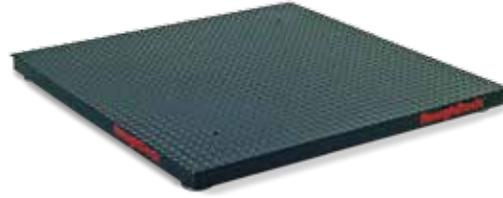

## APPROVALS



Measurement  
Canada  
Approved



# RoughDeck® HP-H

Heavy Capacity Floor Scale

## Part Number/Price

PART #	PART #	SIZE (W X L X H)	CAPACITY	EST. SHIP WEIGHT	PRICE
with Quick Connector	with out Quick Connector				
66474	67717	4 ft x 4 ft x 4 in	20,000 lb (10,000 kg)	601 lb	\$2,850.00
66475	67718	4 ft x 5 ft x 4 in	20,000 lb (10,000 kg)	775 lb	3,050.00
66476	67719	4 ft x 6 ft x 4 in	20,000 lb (10,000 kg)	926 lb	3,250.00
66477	67720	4 ft x 7 ft x 4 in	20,000 lb (10,000 kg)	1,135 lb	3,450.00
66478	67721	5 ft x 5 ft x 4 in	20,000 lb (10,000 kg)	926 lb	3,350.00
66479	67722	5 ft x 6 ft x 4 in	20,000 lb (10,000 kg)	1,104 lb	3,550.00
66480	67723	5 ft x 7 ft x 4 in	20,000 lb (10,000 kg)	1,377 lb	3,750.00
66481	67724	6 ft x 6 ft x 4 in	20,000 lb (10,000 kg)	1,319 lb	3,850.00
66482	67725	6 ft x 8 ft x 4 in	20,000 lb (10,000 kg)	1,861 lb	4,650.00
66483	67726	7 ft x 9 ft x 4 in	20,000 lb (10,000 kg)	2,408 lb	5,450.00
66484	67727	7 ft x 10 ft x 4 in	20,000 lb (10,000 kg)	2,959 lb	6,150.00
66485	67728	8 ft x 10 ft x 4 in	20,000 lb (10,000 kg)	3,108 lb	6,400.00
66486	67729	4 ft x 4 ft x 5 in	30,000 lb (15,000 kg)	675 lb	3,150.00
66487	67730	4 ft x 5 ft x 5 in	30,000 lb (15,000 kg)	839 lb	3,350.00
66488	67731	4 ft x 6 ft x 5 in	30,000 lb (15,000 kg)	1071 lb	3,550.00
66489	67732	4 ft x 7 ft x 5 in	30,000 lb (15,000 kg)	1,200 lb	3,750.00
66490	67733	5 ft x 5 ft x 5 in	30,000 lb (15,000 kg)	1,021 lb	3,650.00
66491	67734	5 ft x 7 ft x 5 in	30,000 lb (15,000 kg)	1,448 lb	4,050.00
66492	67735	6 ft x 6 ft x 5 in	30,000 lb (15,000 kg)	1,438 lb	4,150.00
66493	67736	7 ft x 10 ft x 5 in	30,000 lb (15,000 kg)	3,372 lb	7,850.00
66494	67737	8 ft x 10 ft x 5 in	30,000 lb (15,000 kg)	3,699 lb	8,280.00

## Options/Accessories

PART #	DESCRIPTION	PRICE
N/A	Smooth deck instead of diamond safety tread plate	No charge
40387	Mounting plate, mild steel, 20 K capacity models (optional)	\$42.00
40388	Mounting plate, mild steel, 30 K capacity models (optional)	42.00
N/A	Four drilled deck holes for scale height adjustment	40.00
19352	RoughDeck floor stand for indicator, 36.3 in high, mild steel	205.00
126384	RoughDeck floor stand for indicator, 48 in high, mild steel	225.00
N/A	Mild steel deck with RL35023S stainless steel FM approved load cells and hardware	+300.00 list price adder
N/A	Mild steel deck with RL35082 welded seal IP67 stainless steel FM approved load cells, and hardware	+500.00 list price adder
N/A	Mild steel deck with RL35082 welded seal IP66/68 stainless steel (FM approved) load cells and hardware	+800.00 list price adder
N/A	Epoxy paint	+90.00 list price adder
N/A	Top access junction box	+100.00 list price adder

Access ramps, pit frames, bumper guards and portability frames available, see end of section for details

# RoughDeck® CS

Coil Scale

FLOOR SCALES

## Specifications

### Capacities:

Scale Capacity	Load Cell and Mount Capacity
40,000 lb	Qty (4) 50,000 lb each
60,000 lb	Qty (4) 50,000 lb each
80,000 lb	Qty (4) 75,000 lb each

### Warranty:

RoughDeck CS weldment five years, load cells two years, all other components one year

### Approvals:

NTEP CC 11-068, Class III, 5,000

## Standard Features

- Capacities: 40,000 to 80,000 lb, consult factory for custom capacities
- Sizes: 5 ft x 5 ft - 6 ft x 6 ft, consult factory for custom sizes
- Height: 11 in
- Deck thickness: 1/2 in smooth top plate
- JB4SS Tuffseal® signal trim junction box
- MVS self-checking mounting system, top access to load cells
- Black epoxy paint
- 20 ft Survivor® EL147HE hostile environment load cell cable



## APPROVALS



## Part Number/Price

PART #	DESCRIPTION	CAPACITY	EST. SHIP WEIGHT	PRICE
107493	5 ft x 5 ft x 11 in	40,000 lb (20,000 kg)	1900 lb	\$9,500.00
107494	5 ft x 5 ft x 11 in	60,000 lb (30,000 kg)	1900 lb	9,500.00
107495	5 ft x 5 ft x 11 in	80,000 lb (40,000 kg)	1900 lb	9,500.00
107496	6 ft x 6 ft x 11 in	40,000 lb (20,000 kg)	2575 lb	11,000.00
107497	6 ft x 6 ft x 11 in	60,000 lb (30,000 kg)	2575 lb	11,000.00
107498	6 ft x 6 ft x 11 in	80,000 lb (40,000 kg)	2575 lb	11,000.00

## Options/Accessories

PART #	DESCRIPTION	PRICE
114678	V-Top coil cradle (5 x 5 scale)	\$2,500.00
114684	V-Top coil cradle (6 x 6 scale)	3,100.00
Consult	Pit coping	Consult

www.ricelake.com | Phone: 800-472-6703

RICELAKE

# RoughDeck® CS

Coil Scale

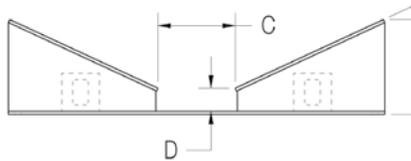
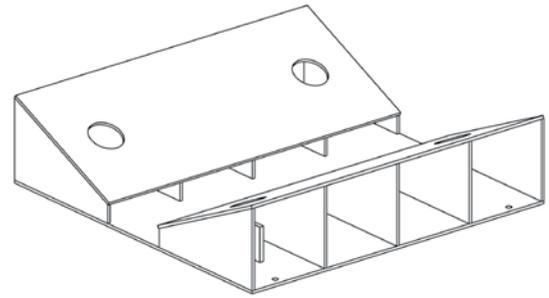
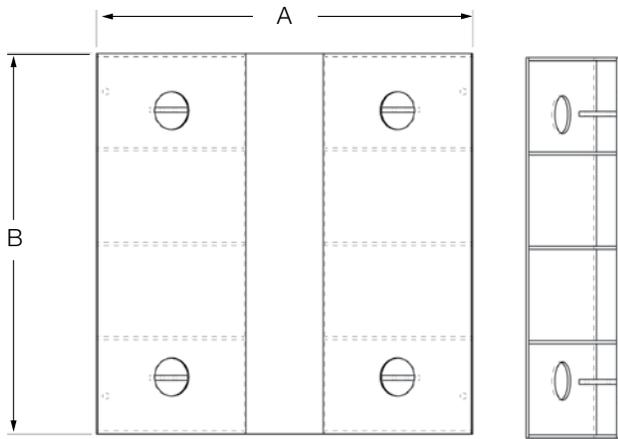

V-Top Coil Cradle

DIMENSIONS			
<b>5 x 5 V-Top Coil Cradle</b>			
A	60 in	D	3.64 in
B	60 in	E	14.95 in
C	12.30 in	F	25°
<b>6 x 6 V-Top Coil Cradle</b>			
A	72 in	D	3.99 in
B	72 in	E	14.96 in
C	22.62 in	F	24°

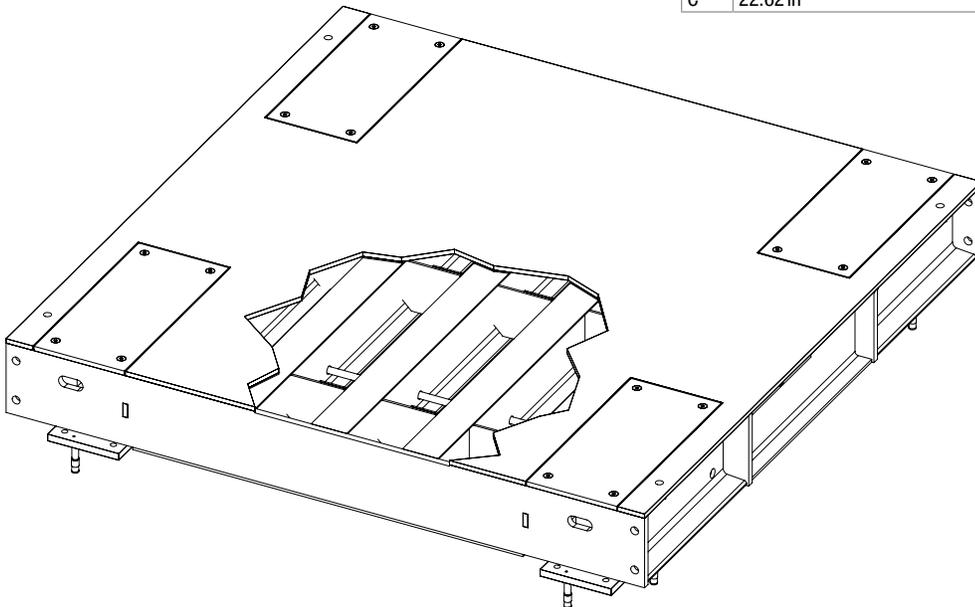

# RoughDeck® SS

Stainless Steel Low-Profile Floor Scale

## Specifications

### End Load Capacity:

- 200% full scale at 1,000 lbs
- 100% full scale at 2,000 lbs and 5,000 lbs
- 80% full scale at 10,000 lbs

### Cable Length:

20 ft (6.1 m) (for connecting junction box to indicator)

### Threaded Eyebolt:

Hole (1/2-20NF) located in center of deck for easy lifting

### Warranty:

RoughDeck SS weldment five years, load cells two years, all other components one year

### Approvals:

NTEP CC 92-001, Class III 5000d  
Measurement Canada AM-4827, Class III 5,000d  
AM-5301



## APPROVALS



Measurement  
Canada  
Approved



## Standard Features

- Rugged non-corrosive design
- 304 stainless steel construction
- Rigid stainless steel channel frame
- Four stainless steel NTEP Certified shear beam load cells
- 20 ft of SURVIVOR® EL147HE hostile environment load cell cable
- Side access junction box
- TuffSeal® JB4SS stainless steel, NEMA 4X junction box with signal trim card
- Smooth stainless steel deck
- Four adjustable stainless steel SUREFOOT™ support feet

## Part Number/Price

PART #	SIZE (W X L X H)	CAPACITY	EST. SHIP WEIGHT	PRICE
18663†	2.5 ft x 2.5 ft x 3.5 in	2,000 lb (1,000 kg)	173 lb	\$2,645.00
46239†	3 ft x 3 ft x 3.5 in	1,000 lb (500 kg)	232 lb	2,975.00
18664†	3 ft x 3 ft x 3.5 in	2,000 lb (1,000 kg)	232 lb	2,975.00
46241	4 ft x 4 ft x 3.5 in	1,000 lb (500 kg)	375 lb	4,035.00
18665	4 ft x 4 ft x 3.5 in	5,000 lb (2,500 kg)	375 lb	4,035.00
18666	4 ft x 4 ft x 3.5 in	10,000 lb (5,000 kg)	490 lb	5,935.00
18667	4 ft x 5 ft x 3.5 in	5,000 lb (2,500 kg)	437 lb	4,605.00
18668	4 ft x 5 ft x 3.5 in	10,000 lb (5,000 kg)	567 lb	6,875.00
18671	5 ft x 5 ft x 3.5 in	5,000 lb (2,500 kg)	541 lb	5,145.00
18672	5 ft x 5 ft x 3.5 in	10,000 lb (5,000 kg)	696 lb	7,780.00
18676	5 ft x 7 ft x 3.5 in	10,000 lb (5,000 kg)	929 lb	10,195.00

## Options/Accessories

PART #	DESCRIPTION	PRICE
18778	Floor anchor plates, stainless steel (set of two)	\$32.00
N/A	Four drilled deck holes for scale height adjustment	40.00
N/A	Stainless steel deck with RLH35 welded seal IP67 stainless steel (FM approved) load cells and hardware	+200.00 list price adder
N/A	Stainless steel deck with RL35082 welded seal IP66/68 stainless steel (FM approved) load cells and hardware	+500.00 list price adder
28740	RoughDeck floor stand for indicator, 36.3 in high, stainless steel	310.00
Consult	Stainless steel diamond treadplate safety deck	Consult

† Not recommended for use with pallet jacks

Access ramps, pit frames, bumper guards and portability frames available, see end of section for details

# RoughDeck® HE

Hostile Environment Stainless Steel Low-Profile Floor Scale

## Specifications

### End Load Capacity:

100% full scale at 2,000 lb and 5,000 lb  
80% full scale at 10,000 lb

### Cable Length:

20 ft (6.1 m)

### Threaded Eyebolt:

Hole (1/2-20NF) located in center of deck for easy lifting

### Warranty:

RoughDeck HE weldment five years, load cells two years, all other components one year

### Approvals:

NTEP Certified, CC 92-001  
Class III 5000d



## APPROVALS



## Standard Features

- Rugged washdown design
- 304 stainless steel construction
- Rigid 304 stainless steel channel frame
- Four stainless steel, welded-seal IP67, shear beam load cells
- 20 ft of SURVIVOR® EL147HE hostile environment load cell cable
- Remote TuffSeal® JB4SS stainless steel, NEMA 4X junction box with signal trim card for remote mounting
- Load cells protected on all four sides
- Smooth stainless steel deck
- Four stainless steel, welded-seal IP67, shear beam load cells

## Part Number/Price

PART #	SIZE (W X L X H)	CAPACITY	EST. SHIP WEIGHT	PRICE
18680*	2.5 ft x 2.5 ft x 3.5 in	2,000 lb (1,000 kg)	173 lb	\$2,845.00
18681*	3 ft x 3 ft x 3.5 in	2,000 lb (1,000 kg)	232 lb	3,175.00
18682	4 ft x 4 ft x 3.5 in	5,000 lb (2,500 kg)	375 lb	4,235.00
18683	4 ft x 4 ft x 3.5 in	10,000 lb (5,000 kg)	490 lb	6,135.00
18684	4 ft x 5 ft x 3.5 in	5,000 lb (2,500 kg)	437 lb	4,805.00
18685	4 ft x 5 ft x 3.5 in	10,000 lb (5,000 kg)	567 lb	7,075.00
18688	5 ft x 5 ft x 3.5 in	5,000 lb (2,500 kg)	541 lb	5,345.00
18689	5 ft x 5 ft x 3.5 in	10,000 lb (5,000 kg)	696 lb	7,980.00
18693	5 ft x 7 ft x 3.5 in	10,000 lb (5,000 kg)	929 lb	10,395.00

## Options/Accessories

PART #	DESCRIPTION	PRICE
18778	Floor anchor plates, stainless steel (set of two)	\$32.00
N/A	Four drilled deck holes for scale height adjustment	40.00
N/A	Stainless steel deck with RL35082 welded seal IP66/68 stainless steel (FM approved) load cells and hardware	+300.00 list price adder
28740	RoughDeck floor stand for indicator, 36.3 in high, stainless steel	310.00
Consult	Stainless steel diamond treadplate safety deck	Consult

\*Not recommended for use with pallet jacks

Access ramps, pit frames, bumper guards and portability frames available, see end of section for details

## AutoLift HE

Hostile Environment Stainless Steel Low-Profile Lift Floor Scale

### Specifications

**End Load Capacity:**

100% full scale at 2,000 lb and 5,000 lb  
80% full scale at 10,000 lb

**Cable Length:**

20 ft (6.1 m)

**Welding:**

Stitch, consult factory if continuous is required

**Threaded Eyebolt:**

Hole (1/2-20NF) located in center of deck for easy lifting

**Warranty:**

AutoLift HE weldment five years, load cells two years, all other components one year

### Standard Features

- Rugged washdown design
- 304 stainless steel construction
- Rigid 304 stainless steel channel frame
- Manual, drop-in-place, safety bar
- Four stainless steel, welded seal, shear beam load cells
- Load cells protected on all four sides
- 20 ft of SURVIVOR® hostile environment load cell cable
- Remote TuffSeal® JB4SS stainless steel NEMA 4X junction box
- Smooth stainless steel deck
- Four adjustable stainless steel SUREFOOT™ support feet
- Requires 85-100 psi air pressure



### APPROVALS





# AutoLift HE

Hostile Environment Stainless Steel Low-Profile Lift Floor Scale

## Part Number/Price

PART #	SIZE (W X L)	CAPACITY	EST. SHIP WEIGHT	PRICE
42207	4 ft x 4 ft	2,000 lb (1,000 kg)	640 lb	\$12,200.00
42208	4 ft x 4 ft	5,000 lb (2,500 kg)	640 lb	12,200.00
42209	4 ft x 4 ft	10,000 lb (5,000 kg)	750 lb	12,600.00
42211	5 ft x 5 ft	2,000 lb (1,000 kg)	830 lb	14,500.00
42212	5 ft x 5 ft	5,000 lb (2,500 kg)	830 lb	14,500.00
42213	5 ft x 5 ft	10,000 lb (5,000 kg)	1,050 lb	14,900.00

## Options/Accessories

PART #	DESCRIPTION	PRICE
Consult	Four drilled deck holes for scale height adjustment	\$40.00
28740	Floor stand for indicator, 36.3 in high stainless steel	310.00

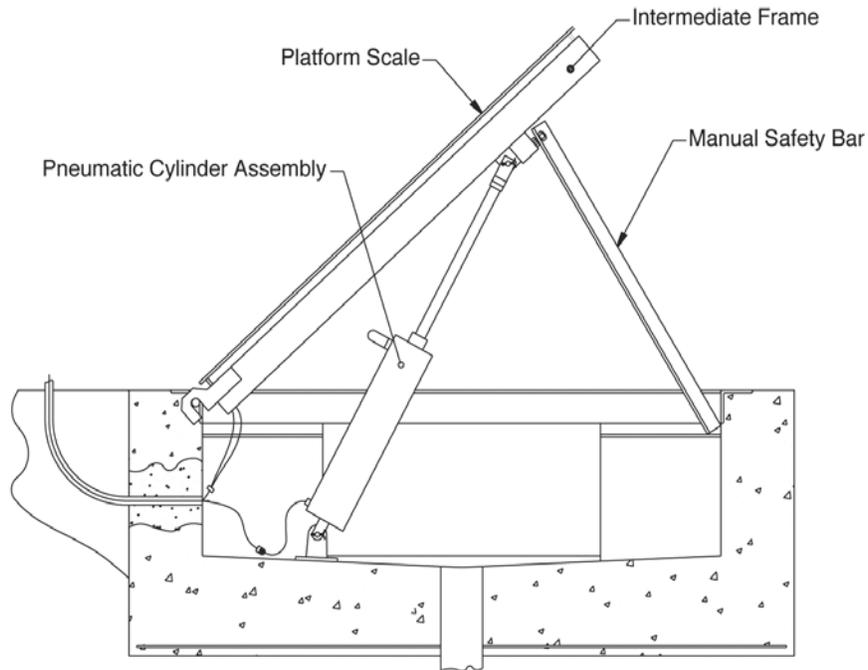

# RoughDeck® QC

Quick Clean Stainless Steel Floor Scale

## Specifications

**End Load Capacity:**

100% full scale at 2,000 lb and 5,000 lb  
80% full scale at 10,000 lb

**Cable Length:**

20 ft (6.1 m) (for connecting junction box to indicator)

**Remote Junction Box:**

Stainless steel enclosure can be located up to 10 ft away from scale

**Welding:**

Stitch, consult if continuous is required

**Threaded Eyebolt:**

Hole (1/2-20NF) located in center of deck for easy lifting

**Warranty:**

RoughDeck QC weldment five years, load cells two years, all other components one year

**Approvals:**

NTEP CC 92-001, Class III 5000d



## Standard Features

- Rugged washdown design
- Smooth, 304 stainless steel top deck
- Rigid 304 stainless steel tube frame
- Manual drop-in-place safety bar
- Four stainless steel, welded seal IP67, shear beam load cells
- 20 ft of SURVIVOR® EL147HE hostile environment load cell cable
- Remote TuffSeal® JB4SS stainless steel NEMA 4X junction box
- 3/16 in thick top plate
- Four adjustable stainless steel SUREFOOT™ support feet

## APPROVALS



*Standard RoughDeck QC is not designed for fork truck traffic or point loading. Please consult factory for pricing on RoughDeck QC special if your application involves either.*

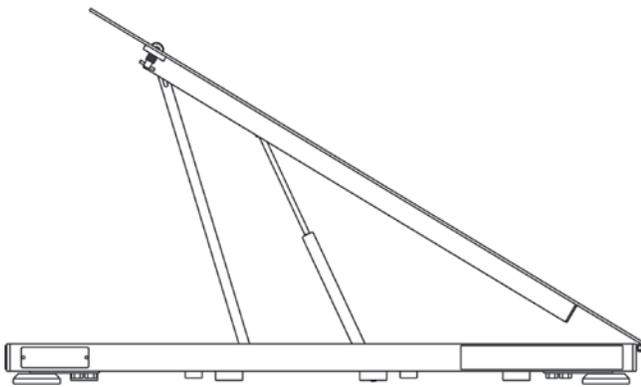

*(Upright position)  
(Hinges are located on "L" dimension)*

*Underdeck View*

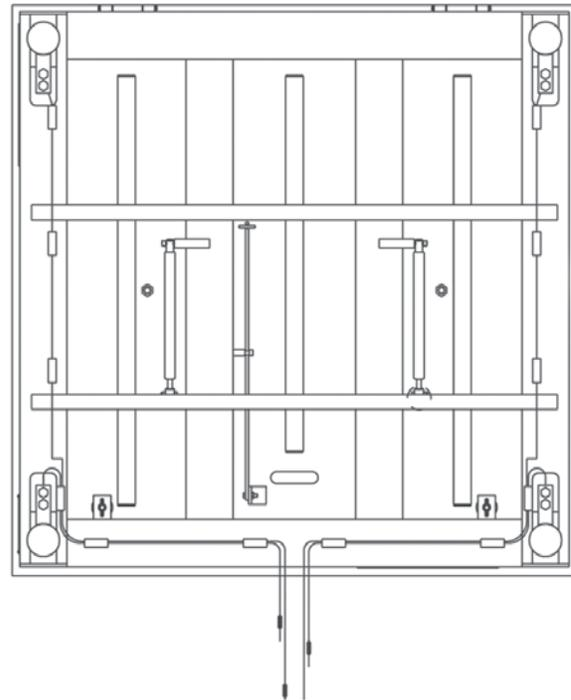

### Part Number/Price

PART #	SIZE (W X L X H)	CAPACITY	EST. SHIP WEIGHT	PRICE
50402	2.5 ft x 2.5 ft x 3.5 in	2,000 lb (1,000 kg)	158 lb	\$4,650.00
50403	3 ft x 3 ft x 3.5 in	2,000 lb (1,000 kg)	208 lb	5,100.00
50404	4 ft x 4 ft x 3.5 in	2,000 lb (1,000 kg)	338 lb	5,750.00
50405	4 ft x 4 ft x 3.5 in	5,000 lb (2,500 kg)	338 lb	5,750.00
50406	4 ft x 4 ft x 4.5 in	10,000 lb (5,000 kg)	447 lb	6,200.00
50407	4 ft x 5 ft x 3.5 in	2,000 lb (1,000 kg)	406 lb	6,415.00
50408	4 ft x 5 ft x 4.5 in	5,000 lb (2,500 kg)	406 lb	6,415.00
50409	4 ft x 5 ft x 4.5 in	10,000 lb (5,000 kg)	540 lb	7,075.00
50410	4 ft x 6 ft x 4.5 in	2,000 lb (1,000 kg)	477 lb	7,075.00
50411	4 ft x 6 ft x 4.5 in	5,000 lb (2,500 kg)	477 lb	7,075.00
50412	4 ft x 6 ft x 5.5 in	10,000 lb (5,000 kg)	637 lb	7,750.00
50413	5 ft x 5 ft x 4.5 in	2,000 lb (1,000 kg)	478 lb	7,075.00
50414	5 ft x 5 ft x 4.5 in	5,000 lb (2,500 kg)	478 lb	7,075.00
50415	5 ft x 5 ft x 4.5 in	10,000 lb (5,000 kg)	637 lb	8,915.00
50416	5 ft x 7 ft x 5.5 in	2,000 lb (1,000 kg)	705 lb	9,610.00
50417	5 ft x 7 ft x 5.5 in	5,000 lb (2,500 kg)	705 lb	9,610.00
50418	5 ft x 7 ft x 5.5 in	10,000 lb (5,000 kg)	908 lb	10,710.00

### Options/Accessories

PART #	SIZE (W X L X H)	EST. SHIP WEIGHT	PRICE
28740	Floor stand for indicator, 36.3 in high, stainless steel		\$310.00
N/A	Stainless steel diamond treadplate safety deck		Consult
<b>Access Ramps</b>			
69193	2.5 ft W x 4.0 ft L x 3.5 in H (works with pn 50402)	152 lb	1,335.00
69194	3.0 ft W x 4.0 ft L x 3.5 in H (works with pn 50403)	177 lb	1,335.00
69195	4.0 ft W x 4.0 ft L x 3.5 in H (works with pns 50404, 50405 and 50407)	224 lb	1,855.00
69217	4.0 ft W x 4.0 ft L x 4.5 in H (works with pns 50406, 50408, 50410 and 50411)	234 lb	1,875.00
69218	4.0 ft W x 4.0 ft L x 4.5 in H (works with pn 50409)	234 lb	1,875.00
69222	4.0 ft W x 5.0 ft L x 5.5 in H (works with pn 50412)	330 lb	2,420.00
69219	5.0 ft W x 4.0 ft L x 4.5 in H (works with pn 50413 and 50414)	272 lb	2,285.00
69220	5.0 ft W x 4.0 ft L x 4.5 in H (works with pn 50415)	272 lb	2,285.00
69223	5.0 ft W x 5.0 ft L x 5.5 in H (works with pn 50416, 50417 and 50418)	380 lb	2,995.00
<b>Pit Frames</b>			
64768	2.5 ft W x 2.5 ft L x 4 in D (works with pn 50402)	89 lb	1,035.00
64769	3.0 ft W x 3.0 ft L x 4 in D (works with pn 50403)	102 lb	1,035.00
64770	4.0 ft W x 4.0 ft L x 4 in D (works with pn 50404 and 50405)	127 lb	1,335.00
64771	4.0 ft W x 4.0 ft L x 5 in D (works with pn 50406)	158 lb	1,535.00
64772	4.0 ft W x 5.0 ft L x 4 in D (works with pn 50407)	140 lb	1,535.00
64773	4.0 ft W x 5.0 ft L x 5 in D (works with pn 50408)	175 lb	1,715.00
64774	4.0 ft W x 5.0 ft L x 5 in D (works with pn 50409)	175 lb	1,715.00
64775	4.0 ft W x 6.0 ft L x 5 in D (works with pn 50410 and 50411)	191 lb	1,875.00
64776	4.0 ft W x 6.0 ft L x 6 in D (works with pn 50412)	225 lb	1,975.00
64777	5.0 ft W x 5.0 ft L x 5 in D (works with pn 50413 and 50414)	191 lb	1,875.00
64778	5.0 ft W x 5.0 ft L x 5 in D (works with pn 50415)	191 lb	1,875.00
64779	5.0 ft W x 7.0 ft L x 6 in D (works with pn 50416, 50417 and 50418)	270 lb	2,215.00

# RoughDeck® SD

Sanitary Deck Floor Scale

## Specifications

**End Load Capacity:**

- 100% full scale at 2,000 lb & 5,000 lb
- 80% full scale at 10,000 lb

**Cable Length:**

20 ft (6.1 m) (for connecting junction box to indicator)

**Remote Junction Box:**

Stainless steel enclosure can be located up to 10 ft away from scale

**Warranty:**

RoughDeck SD weldment and load cells two years, all other components one year

**Approvals:**

NTEP CC 92-001, Class III 5000d

## Standard Features

- Rugged washdown design
- 304 stainless steel construction
- Rigid stainless steel tube frame
- Four stainless steel, welded seal, shear beam load cells
- Load cells protected on all four sides
- 20 ft (6 m) of SURVIVOR® EL147HE hostile environment load cell cable
- Remote TuffSeal® JB4SS stainless steel NEMA 4X junction box
- Four adjustable stainless steel SUREFOOT™ support feet
- Removable polyethylene deck (Deck weight: 80 lb (36.6 kg) on 4 ft x 4 ft size)
- Side brackets to hold deck during washdown



*Important NOTE: Applications where oily substances may be spilled could cause the deck to become slippery—caution should be used. The RoughDeck QC is recommended in these instances.*

## APPROVALS



Underdeck View

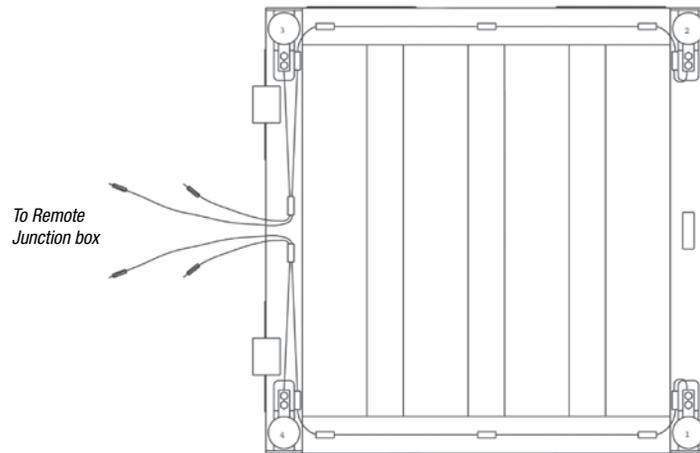

Side View



Bracket to hold polyethylene top deck when cleaning under scale

# RoughDeck® SD

Sanitary Deck Floor Scale

## Part Number/Price

PART #	SIZE (W X L X H)	CAPACITY	EST. SHIP WEIGHT	PRICE
50385	2.5 ft x 2.5 ft x 4.4 in	2,000 lb	158 lb	\$3,880.00
50386	3 ft x 3 ft x 4.4 in	2,000 lb	208 lb	3,995.00
50387	4 ft x 4 ft x 4.4 in	2,000 lb	338 lb	4,210.00
50388	4 ft x 4 ft x 4.4 in	5,000 lb	338 lb	4,210.00
50389	4 ft x 4 ft x 5.4 in	10,000 lb	447 lb	4,435.00
50390	4 ft x 5 ft x 4.4 in	2,000 lb	406 lb	4,655.00
50391	4 ft x 5 ft x 5.4 in	5,000 lb	406 lb	4,655.00
50392	4 ft x 5 ft x 5.4 in	10,000 lb	540 lb	4,870.00
50393	4 ft x 6 ft x 5.4 in	2,000 lb	477 lb	5,100.00
50394	4 ft x 6 ft x 5.4 in	5,000 lb	477 lb	5,100.00
50395	4 ft x 6 ft x 6.4 in	10,000 lb	637 lb	5,645.00
50396*	5 ft x 5 ft x 5.4 in	2,000 lb	478 lb	5,100.00
50397*	5 ft x 5 ft x 5.4 in	5,000 lb	478 lb	5,100.00
50398*	5 ft x 5 ft x 5.4 in	10,000 lb	637 lb	5,645.00
50399*	5 ft x 7 ft x 6.4 in	2,000 lb	705 lb	7,190.00
50400*	5 ft x 7 ft x 6.4 in	5,000 lb	705 lb	7,190.00
50401*	5 ft x 7 ft x 6.4 in	10,000 lb	908 lb	8,175.00

\* Constructed of two pieces of polyethylene to make up the top deck.

## Options/Accessories

PART #	DESCRIPTION	PRICE
28740	RoughDeck floor stand for indicator, 36.3 in high, stainless steel	\$310.00

Consult factory for these additional options:

- Access ramps
- Pit frames

# RoughDeck® BDP

Barrel Scale – Standard Model

## Specifications

**End Load Capacity:**

- 1000 lb: 100% full scale
- 2500 lb: 80% full scale

**Cable Length:**

10 ft (3 m)

**Threaded Eyebolt:**

Hole (1/2-13NC) located in center of deck for easy lifting

**Warranty:**

RoughDeck BDP weldment three years, load cells two years, all other components one year

**Approvals:**

- NTEP CC 03-060, Class III 2,500d
- Measurement Canada AM-5578 (500 kg) Class III 2,500d (1000 kg) Class III 2,000d



## APPROVALS



Measurement  
Canada  
Approved



## Standard Features

- Live siderails
- Top access foot adjustment holes (holes are 1/2-13 threaded for lifting scale)
- Four adjustable stainless steel SUREFOOT™ support feet
- 30 in x 31 in or 36 in x 37 in weighing surface (not including side rails)
- TuffSeal® JB4SS stainless steel, NEMA 4x junction box with signal trim card

**Mild Steel Models**

- Treaded top plate
- Alloy steel load cells

**Stainless Steel Models**

- Smooth top plate
- Stainless steel or stainless steel with welded-seal (IP67) load cells

### ROUGHDECK BDP WITH ACCESS RAMP DIMENSIONS

30 in x 31 in models			
A	30.0 in (762 mm)	D	3.31 in (84.1 mm)
B	31.0 in (787.4 mm)	G	30.0 in (762 mm)
C	40.0 in (1016 mm)	H	12.0 in (304.8 mm)
36 in x 37 in models			
A	36.0 in (914.4 mm)	D	3.31 in (84.1 mm)
B	37.0 in (939.8 mm)	G	36.0 in (914.4 mm)
C	46.0 in (1168.4 mm)	H	12.0 in (304.8 mm)

Distance from floor to top of center weighing surface: 1.625 in (41.2 mm)

Distance from floor to bottom of weighing surface: 0.31 in (7.87 mm)

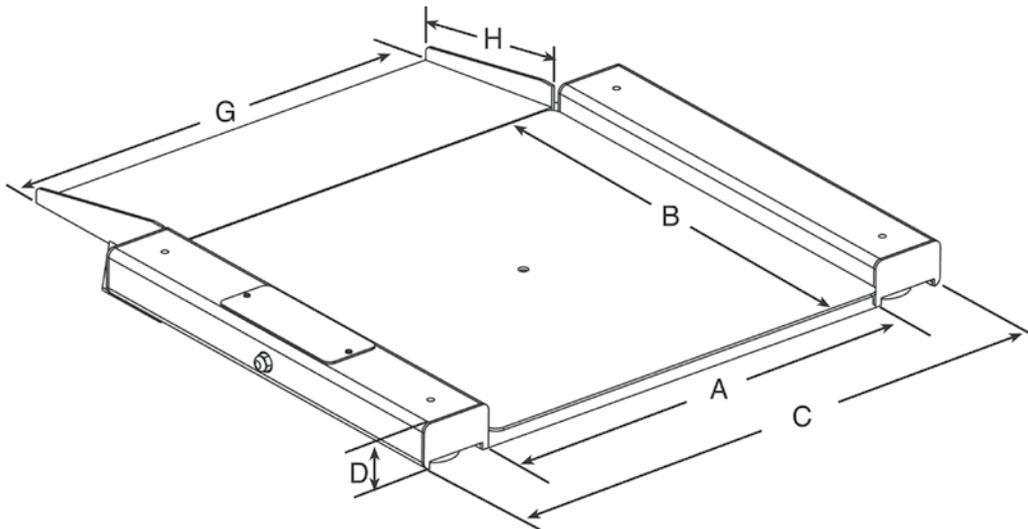

# RoughDeck® BDP

Barrel Scale - Standard Model

## Part Number/Price

PART #	SIZE (W X L)	CAPACITY (CANADIAN APPROVED CAPACITIES)	EST. SHIP WEIGHT	PRICE
<b>NTEP Certified</b>				
Mild Steel				
77962	30 in x 31 in	1,000 lb (500 kg)	205 lb	\$1,595.00
77963	30 in x 31 in	2,500 lb (1,000 kg)	205 lb	1,595.00
77964	36 in x 37 in	1,000 lb (500 kg)	265 lb	1,695.00
77965	36 in x 37 in	2,500 lb (1,000 kg)	265 lb	1,695.00
Stainless Steel				
77967	30 in x 31 in	1,000 lb (500 kg)	205 lb	3,495.00
77968	30 in x 31 in	2,500 lb (1,000 kg)	205 lb	3,495.00
77969	36 in x 37 in	1,000 lb (500 kg)	265 lb	3,595.00
77970	36 in x 37 in	2,500 lb (1,000 kg)	265 lb	3,595.00
Stainless Steel with Stainless Steel Welded-Seal (IP67) Load Cells				
77971	30 in x 31 in	1,000 lb (500 kg)	205 lb	3,695.00
77972	30 in x 31 in	2,500 lb (1,000 kg)	205 lb	3,695.00
77973	36 in x 37 in	1,000 lb (500 kg)	265 lb	3,795.00
77974	36 in x 37 in	2,500 lb (1,000 kg)	265 lb	3,795.00
<b>Access Ramps</b>				
Mild Steel				
78011	30 in x 12 in (sold individually)		25 lb	200.00
78012	36 in x 12 in (sold individually)		30 lb	200.00
Stainless Steel				
78013	30 in x 12 in (sold individually)		25 lb	315.00
78014	36 in x 12 in (sold individually)		30 lb	315.00

## Options/Accessories

PART #	DESCRIPTION	PRICE
18777	Floor anchor plates, mild steel, set of two (for use with static scale, without ramps)	\$30.00
18778	Floor anchor plates, stainless steel, set of two (for use with static scale, without ramps)	32.00
19352	RoughDeck floor stand for indicator, 36.3 in high, mild steel (for use with static scale)	205.00
126384	RoughDeck floor stand for indicator, 48 in high, mild steel	225.00
28740	Floor stand for indicator, 36.3 in high, stainless steel (for use with static scale)	310.00

# RoughDeck® BDP

Barrel Scale – Standard Model with Portability Option

## Specifications

### End Load Capacity:

- 1,000 lb: 100% full scale
- 2500 lb: 80% full scale

### Cable Length:

10 ft (3 m)

### Threaded Eyebolt:

Hole (1/2-13NC) located in center of deck for easy lifting

### Warranty:

RoughDeck BDP weldment three years, load cells two years, all other components one year

### Approvals:

NTEP CC 03-060, Class III 2,500d  
 Measurement Canada AM-5578  
 (500 kg) Class III 2,500d  
 (1000 kg) Class III 2,000d

## Standard Features

- Live siderails
- Top access foot adjustment holes
- Holes are 1/2-13 threaded for lifting scale
- Four adjustable stainless steel SUREFOOT™ support feet
- 30 x 31 in or 36 x 37 in weighing surface (not including side rails)
- TuffSeal® JB4SS Stainless Steel, NEMA 4X junction box with signal trim card

### Mild Steel Models

- Treaded top plate
- Alloy steel load cells

### Stainless Steel Models

- Smooth top plate
- Stainless steel or stainless steel with welded-seal (IP67) load cells



Scale shown with optional portability kit

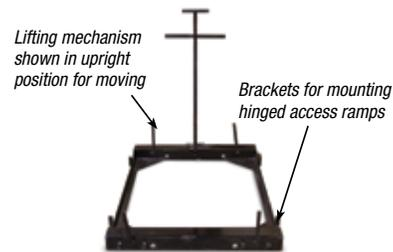

Portability Kit

## DIMENSIONS WITH PORTABILITY FRAME AND HINGED ACCESS RAMPS

30 in x 31 in models			
A	30.0 in (762 mm)	I	49.25 in (1250.9 mm)
B	31.0 in (787.4 mm)	J	52.25 in (1327.1 mm)
D	3.66 in (92.9 mm)	L	40.37 in (1025.4 mm)
G	29.25 in (742.9 mm)	M	12.0 in (304.8 mm)
H	3.25 in (82.5 mm)		
36 in x 37 in models			
A	36.0 in (914.4 mm)	I	55.25 in (1403.4 mm)
B	37.0 in (939.8 mm)	J	58.25 in (1479.5 mm)
D	3.66 in (92.9 mm)	L	40.37 in (1025.4 mm)
G	35.25 in (895.3 mm)	M	12.0 in (304.8 mm)
H	3.25 in (82.5 mm)		

Distance from floor to top of center weighing surface: 1.94 in (49.2 mm)

Distance from floor to bottom of weighing surface: 0.62 in (15.7 mm)

## APPROVALS



Measurement  
Canada  
Approved

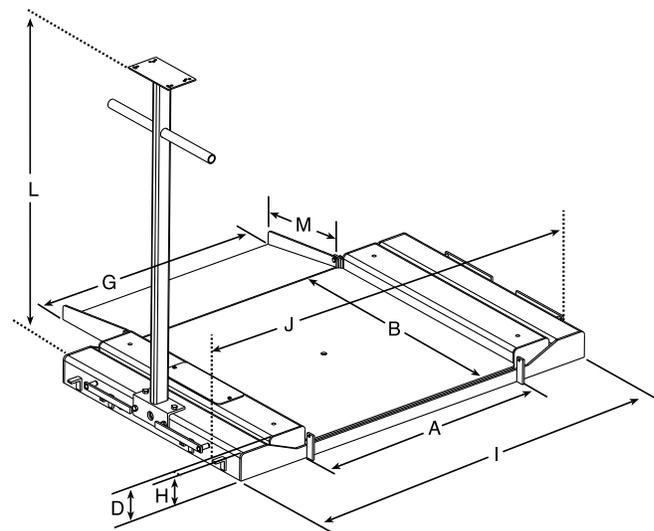



# RoughDeck® BDP

Barrel Scale - Standard Model with Portability Option

## Part Number/Price

PART #	SIZE (W X L)	CAPACITY (CANADIAN APPROVED CAPACITIES)	EST. SHIP WEIGHT	PRICE
<b>BDP Scale</b>				
Mild Steel				
77962	30 x 31 in	1,000 lb (500 kg)	205 lb	\$1,595.00
77963	30 x 31 in	2,500 lb (1,000 kg)	205 lb	1,595.00
77964	36 x 37 in	1,000 lb (500 kg)	265 lb	1,695.00
77965	36 x 37 in	2,500 lb (1,000 kg)	265 lb	1,695.00
Stainless Steel				
77967	30 x 31 in	1,000 lb (500 kg)	205 lb	3,495.00
77968	30 x 31 in	2,500 lb (1,000 kg)	205 lb	3,495.00
77969	36 x 37 in	1,000 lb (500 kg)	265 lb	3,595.00
77970	36 x 37 in	2,500 lb (1,000 kg)	265 lb	3,595.00
Stainless steel with stainless steel welded-seal (IP67) load cells				
77971	30 x 31 in	1,000 lb (500 kg)	205 lb	3,695.00
77972	30 x 31 in	2,500 lb (1,000 kg)	205 lb	3,695.00
77973	36 x 37 in	1,000 lb (500 kg)	265 lb	3,795.00
77974	36 x 37 in	2,500 lb (1,000 kg)	265 lb	3,795.00
<b>Portability Kits</b>				
Kits include: Frame, Two swivel and two fixed zinc plated steel NSF approved wheels (75 lb max. load capacity), Indicator stand (suitable for 320IS, 320IS plus, IQ plus® 390, 420 plus, IQ plus® 590, 480 Legend				
Mild Steel				
78021	For use with 30 x 31 in scale		90 lb	750.00
78022	For use with 36 x 37 in scale		100 lb	750.00
Stainless Steel				
78023	For use with 30 x 31 in scale		90 lb	1,025.00
78024	For use with 36 x 37 in scale		100 lb	1,080.00
<b>Hinged Access Ramps: For use with portability kit</b>				
Mild Steel				
78015	29.25 in x 12 in (sold individually)		25 lb	200.00
78016	35.25 in x 12 in (sold individually)		30 lb	200.00
Stainless Steel				
78017	29.25 in x 12 in (sold individually)		25 lb	315.00
78018	35.25 in x 12 in (sold individually)		30 lb	315.00

# DeckHand Rough-n-Ready System

Portable Scale

## Specifications

**End Load Capacity:**

100% end loading

**mV/V Output:**

2 mV/V

**Cable length:**

9ft 10in (3m)

**Height:**

Weighing platter: 4.5in H when in weigh mode

**Column Height:**

59in

**Warranty:**

Load cells two years, all other components one year

**Approvals:**

NTEP CC 98-004, Class III, 2,500d  
Measurement Canada AM-5218,  
(250 kg and 500 kg) Class III 2,500d  
(1,000 kg) Class III 2,000d



Shown with optional ramp

## Standard Features

- Mild steel wheeled frame, base, and mast
- 500 lb, 1,000 lb, 2,000 lb capacity
- Large rubber wheels simplify movement on uneven floors
- Aluminum load cells (2)
- Package includes: Mild steel DeckHand Portable Scale and IQ plus® 590-DC indicator
- Battery life 40 hours continuous
- Factory-wired and calibrated
- See IQ plus 590-DC for Indicator specifications.

## APPROVALS



Measurement  
Canada  
Approved

## Part Number/Price

PART #	OVERALL SIZE (W X L X H)	CAPACITY	EST. SHIP WEIGHT	PRICE
<b>Mild Steel with IQ plus® 590-DC, 115 VAC Indicator</b>				
69525	31 x 41 x 4.5 in	500 lb	343 lb*	\$2,725.00
69526	31 x 41 x 4.5 in	1,000 lb	363 lb*	2,725.00
69527	31 x 41 x 4.5 in	2,000 lb	380 lb*	2,825.00
<b>Mild Steel with IQ plus® 590-DC, 230 VAC Indicator</b>				
69528	31 x 41 x 4.5 in	500 lb	343 lb*	2,725.00
69529	31 x 41 x 4.5 in	1,000 lb	363 lb*	2,725.00
69530	31 x 41 x 4.5 in	2,000 lb	380 lb*	2,825.00

## Options/Accessories

PART #	DESCRIPTION	EST. SHIP WEIGHT	PRICE
43376	Ramp assembly, 500/1,000 lb, mild steel, 25 x 27 in	100 lb	\$240.00
43378	Ramp assembly, 2,000 lb, mild steel, 25 x 27 in	100 lb	285.00
<b>DeckHand Portable Scale Optional Indicator Mounts</b>			
41371	Mounting bracket for 320IS with battery option stainless steel		90.00

\* Approximate weight for scale and indicator

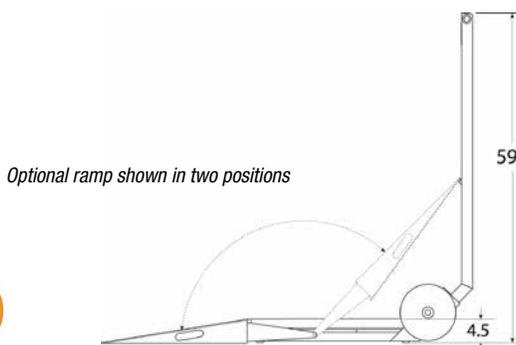

Optional ramp shown in two positions

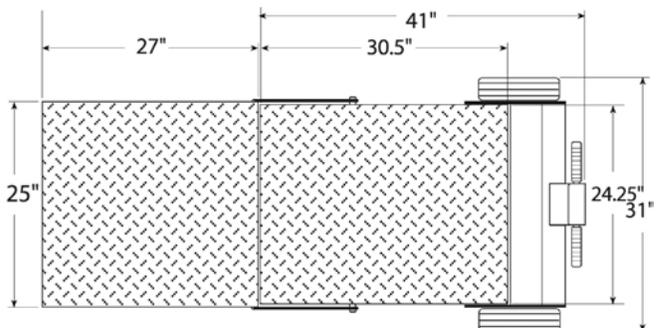

# DeckHand

Portable Scale

## Specifications

**End Load Capacity:**

100% end loading

**mV/V Output:**

2 mV/V

**Cable length:**

9 ft 10 in (3 m)

**Height:**

Weighing platter: 4.5 in H when in weigh mode

**Column Height:**

59 in

**Warranty:**

DeckHand weldment five years, load cells two years, all other components one year

**Approvals:**

NTEP Certified, CC 98-004, Class III, 2500d  
Measurement Canada approved, AM-5218

Scale  
Only



## Standard Features

- Mild or stainless steel frame, base, and mast
- 500 lb, 1,000 lb, 2,000 lb capacity
- Large rubber wheels simplify movement on uneven floors
- Aluminum load cells (2)
- Standard indicator mount with integral handles for the IQ plus® 355, IQ plus 390-DC, IQ plus 510, IQ plus 590-DC, and IQ 700

## APPROVALS



Measurement  
Canada  
Approved



## Part Number/Price

PART #	OVERALL SIZE (W X L X H)	CAPACITY	EST. SHIP WEIGHT	PRICE
<b>Mild Steel</b>				
41293	31 x 41 x 4.5 in	500 lb	336 lb	\$2,150.00
41294	31 x 41 x 4.5 in	1,000 lb	356 lb	2,150.00
41295	31 x 41 x 4.5 in	2,000 lb	373 lb	2,250.00
<b>Stainless Steel</b>				
41296	31 x 41 x 4.5 in	500 lb	336 lb	3,290.00
41297	31 x 41 x 4.5 in	1,000 lb	356 lb	3,290.00
41298	31 x 41 x 4.5 in	2,000 lb	373 lb	3,490.00

## Options/Accessories

PART #	DESCRIPTION	EST. SHIP WEIGHT	PRICE
<b>Mild Steel</b>			
43376	500/1,000 lb mild steel ramp		\$240.00
43378	2,000 lb mild steel ramp		285.00
<b>Stainless Steel</b>			
43377	Ramp assembly, 500/1,000 lb, stainless steel, 25 x 27 in		670.00
43379	Ramp assembly, 2,000 lb, stainless steel, 25 x 27 in		775.00
89576	Clam shell for 1260 load cell, stainless steel		250.00
Consult	Smooth top		N/C
<b>DeckHand Portable Scale Optional Indicator Mounts</b>			
41371	Mounting bracket for 320IS with battery option stainless steel		90.00

\* Approximate weight for scale and indicator

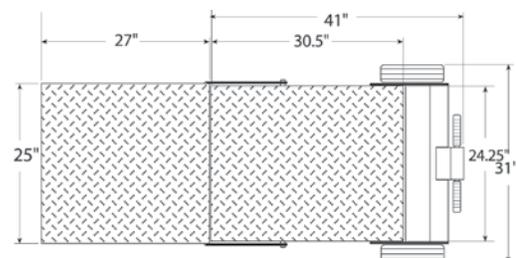
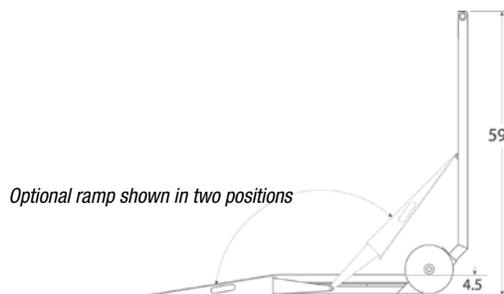

# RL1200

Portable Beam Scale

## Specifications

**Construction:**

Cast-iron platform, base and levers

**Poise:**

Steel locking screw provided

**Platform Dimensions:**

24 in (L) x 18 in (W)

**Capacity:**

1000 lb or 500 kg

**Approvals:**

NTEP Certified 93-004 Class III 2,000d (Avoirdupois Beam Only)

**Warranty:**

One year limited warranty



## Standard Features

- NTEP Certified
- Cast iron construction
- 1000 lb or 500 kg capacity models available
- Locking screw knob on poise
- Slotted cast iron counterpoise weights, marked to scale capacity
- Heavy-duty wheels for portability
- Weights and hanger
- Nickel plated steel beam with engraved brass insert

## Part Number/Price

PART #	OVERALL SIZE (W X L X H)	CAPACITY	EST. SHIP WEIGHT	PRICE
157982	Avoirdupois Beam, NTEP Certified	1000 lb x 0.5 lb	200 lb	\$525.00
157983	Metric Beam, non-NTEP	500 kg x 0.2 kg	200 lb	525.00

## Options/Accessories

PART #	DESCRIPTION	PRICE
157985	Electronic conversion kit for existing scale (includes: load cell, hardware and IQ plus 390-DC indicator)	\$1,045.00

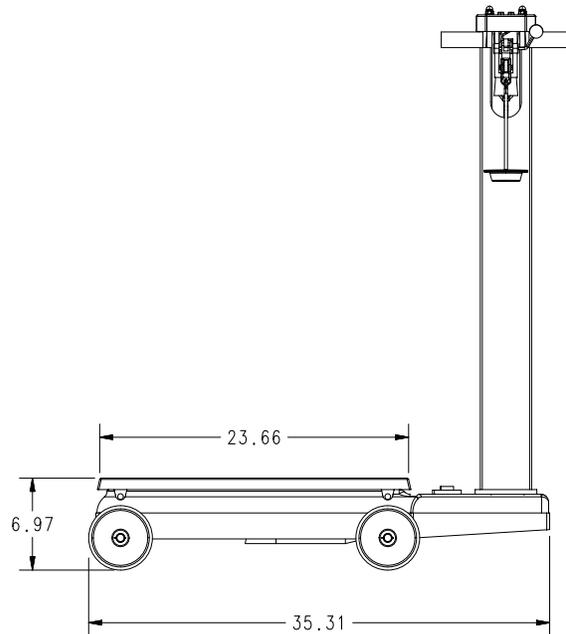
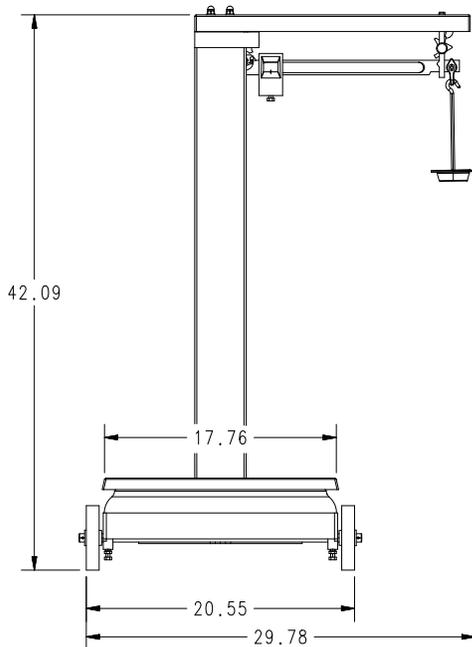

# RL1200 EM

Electromechanical Portable Beam Scale

## Standard Features

- NTEP Certified
- Cast iron construction
- 1000 lb capacity
- Heavy-duty wheels and handle for portability
- IQ plus 390-DC indicator (see IQ plus 390-DC catalog page for specifications)

## Specifications

**Construction:**

Cast-iron platform, base and levers

**Platform Dimensions:**

24 in (L) x 18 in (W)

**Capacity:**

1000 lb

**Approvals:**

NTEP Certified 93-004 Class III 2,000d

**Warranty:**

One year limited warranty



## Part Number/Price

PART #	OVERALL SIZE (W X L X H)	CAPACITY	EST. SHIP WEIGHT	PRICE
157984	Portable Beam with IQ plus 390-DC Indicator, NTEP Certified	1000 lb x 0.5 lb	200 lb	\$1,570.00

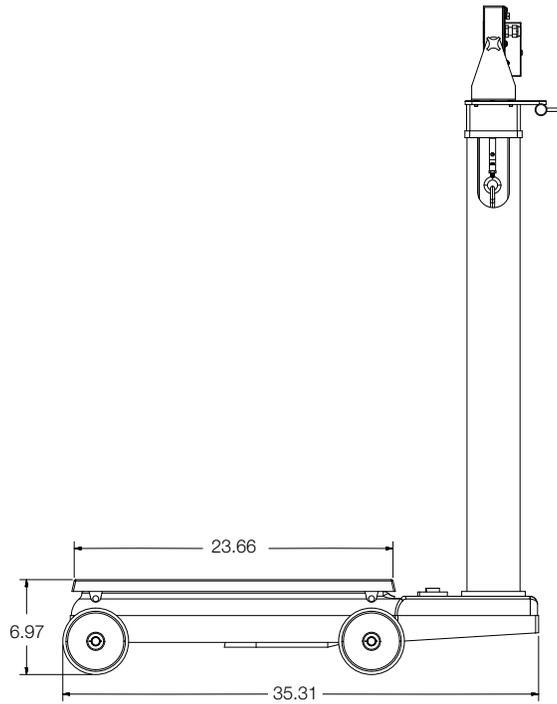
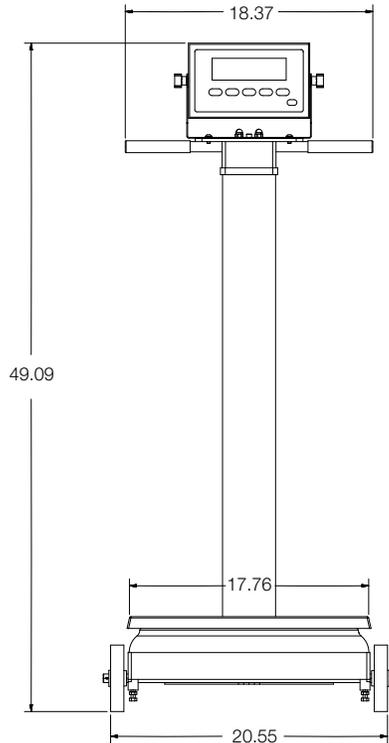

# RoughDeck® FXB

Flexure Lever Floor Scale

## Standard Features: Painted Steel

### Painted Steel

- Unique flexure design filters motion and shock loading
- Spring steel flexures
- Rugged all-steel painted construction
- One Rice Lake Weighing Systems brand RL20000 series nickel-plated S-beam load cell and plated wire rope
- NTEP Certified models in sizes 24 in x 24 in (500 lb) through 72 in x 96 in up to 10,000 lb capacity

### Stainless Steel

- Unique flexure design filters motion and shock loading
- All 304 stainless steel construction
- Stainless flexures, hardware and load cell
- NTEP Certified models in sizes 24 in x 24 in (500 lb) through 72 in x 96 in up to 10,000 lb capacity

## Specifications

### End Loading Capacity:

100% of scale capacity

### Safe Overload Capacity:

150% of scale capacity

### Warranty:

Two-year limited warranty

### Approvals:

Painted Steel: NTEP CC 88-100, Class III 5000d

Stainless Steel: NTEP CC 88-100, Class III 3,000d



## APPROVALS



# RoughDeck® FXB

Painted Steel, Flexure Lever Floor Scale

## Part Number/Price

PART #	SIZE (L X W X H)	CAPACITY	EST. SHIP WEIGHT	PRICE
<b>Painted Steel</b>				
33134	18 in x 24 in x 6.5 in	500 lb (250 kg)	125 lb	\$4,175.00
33066	18 in x 24 in x 6.5 in	1,000 lb (500 kg)	125 lb	4,175.00
113566	18 in x 30 in x 6.5 in	500 lb (250 kg)	133 lb	4,175.00
33136	18 in x 30 in x 6.5 in	1,000 lb (500 kg)	133 lb	4,175.00
113567	18 in x 30 in x 6.5 in	1,500 lb (750 kg)	133 lb	4,175.00
33067	24 in x 24 in x 6.5 in	500 lb (250 kg)	151 lb	4,175.00
33068	24 in x 24 in x 6.5 in	1,000 lb (500 kg)	151 lb	4,175.00
33138	30 in x 30 in x 6.5 in	500 lb (250 kg)	191 lb	4,375.00
33069	30 in x 30 in x 6.5 in	1,000 lb (500 kg)	191 lb	4,375.00
33139	30 in x 30 in x 6.5 in	1,500 lb (750 kg)	191 lb	4,375.00
33070	30 in x 30 in x 8.25 in	2,000 lb (1000 kg)	281 lb	4,565.00
33140	36 in x 36 in x 8.25 in	1,000 lb (500 kg)	234 lb	4,565.00
33071	36 in x 36 in x 8.25 in	2,000 lb (1,000 kg)	234 lb	4,565.00
33072	36 in x 36 in x 8.25 in	5,000 lb (2,500 kg)	234 lb	4,565.00
33141	38 in x 46 in x 8.25 in	1,000 lb (500 kg)	610 lb	4,565.00
113569	38 in x 46 in x 8.25 in	2,000 lb (1,000 kg)	610 lb	4,565.00
113570	38 in x 46 in x 8.25 in	5,000 lb (2,500 kg)	610 lb	4,565.00
113572	48 in x 48 in x 8.25 in	1,000 lb (500 kg)	654 lb	5,265.00
33073	48 in x 48 in x 8.25 in	2,000 lb (1,000 kg)	654 lb	5,265.00
33074	48 in x 48 in x 8.25 in	5,000 lb (2,500 kg)	654 lb	5,265.00
33075	48 in x 48 in x 9.25 in	10,000 lb (5,000 kg)	735 lb	5,835.00
33078	48 in x 60 in x 9.25 in	10,000 lb (5,000 kg)	845 lb	6,700.00
33149	48 in x 72 in x 9.25 in	5,000 lb (2,500 kg)	1120 lb	7,130.00
33080	48 in x 72 in x 9.25 in	10,000 lb (5,000 kg)	1120 lb	7,130.00
<b>Stainless Steel</b>				
113582	24 in x 24 in x 6.5 in	1000 lb (500 kg)	151 lb	5,490.00
113586	30 in x 30 in x 8.25 in	2000 lb (1000 kg)	281 lb	8,310.00
113588	36 in x 36 in x 8.25 in	2000 lb (1000 kg)	450 lb	9,090.00
113595	48 in x 48 in x 8.25 in	5000 lb (2500 kg)	630 lb	12,110.00
33081	60 in x 60 in x 8.25 in	5,000 lb (2,500 kg)	967 lb	6,940.00
33082	60 in x 60 in x 9.25 in	10,000 lb (5,000 kg)	1180 lb	7,180.00
33152	60 in x 60 in x 13.25 in	20,000 lb (10,000 kg)	1674 lb	14,985.00

## Options/Accessories:

PART #	DESCRIPTION	PRICE
Consult	Forklift skid, Painted Steel FXB-3846 through FXB-6084 provides two 8-channels mounted on customer specified centers. Includes 4 leveling feet on base	\$520.00
Consult	Forklift skid with indicator column, Painted Steel FXB-3846 through FXB-6084 provides two 8-channel mounted on customer specified centers with one of the channels extended 12 inches and equipped with bolt on indicator column. Indicator display will be 54 inches above floor level	630.00

# Floor Scale and Indicator Package

## Specifications

### Summit 3000 Floor Scale

#### End Load Capacity

- 100% full scale at 5000 lb (2500 kg)
- 80% full scale at 10,000 lb (5000 kg)

#### Cable Length:

- 20 ft (6.1 m) (for connecting junction box to indicator)

#### Warranty:

- Summit 3000 weldment and load cells two years, all other components one year

#### Approvals:

- NTEP CC 92-001A9, Class III 5,000d
- Measurement Canada AM-5530, Class III 5,000d

### 120/120 Plus Digital Weight Indicator

#### Power:

#### 120/120 Plus:

- Line voltages: 115 or 230VAC
- Frequency: 50 or 60 Hz
- 120 Plus: (estimated battery life)
- 60 hours with 1 x 350 Ω
- 40 hours with 4 x 350 Ω
- Charge time 8 hours

#### Operating Temperature:

- Legal: 14°F to 104°F (-10°C to 40°C)
- Industrial: 14°F to 122°F (-10°C to 50°C)

#### Rating/Material:

- Enclosure: heavy gauge ABS

#### Warranty:

- One-year limited warranty

#### 120 Approvals:

- NTEP CC 03-059, Class III/IIIL 6,000d
- Measurement Canada AM-5517, Class III/IIHD 6,000d OIML TC7028 T 5692, 5,000d
- CE marked

#### 120 Plus Approvals:

- NTEP CC 03-059, Class III/IIIL 6,000d
- Measurement Canada AM 5517
- OIML TC 7626, T5692 5,000d Class III/IIHD 6,000d



Package is configured, corner-trimmed, and calibrated for 5,000 divisions before shipping

#### Floor Scale and Indicator Package

Package includes Summit® 3000 floor scale, 120 PLUS digital weight indicator with tilt stand, 20 ft load cell cable with quick disconnect, configured and calibrated

## INDICATOR APPROVALS



## Standard Features

### Summit® 3000 Floor Scale

- Four NTEP Certified alloy steel shear beam load cells
- Top access junction box
- Rugged diamond safety treadplate steel deck
- Four adjustable rigid polyurethane rubber feet, 3 in (76.2 mm) diameter
- Signal trim summing board housed in ABS enclosure
- Threaded eyebolt hole (1/2–20NF) located in the center of the deck for easy lifting
- 20 ft of EL147 load cell cable with quick disconnect
- Package configured and calibrated for 5,000 divisions

### 120 Digital Weight Indicator

- Large .8 in (20.3 mm) Light Emitting Diode (LED) display
- Five-button operation
- Full front panel digital calibration and configuration

### 120 PLUS Digital Weight Indicator

- Large .8 in backlit Liquid Crystal Display (LCD)
- 115 or 230VAC wall adapter with rechargeable battery



# Floor Scale and Indicator Package

## Part Number/Price

PART #	SIZE (W X L X H)	CAPACITY	EST. SHIP WEIGHT	PRICE
<b>Floor Scale and Indicator Package (Single Scale)</b>				
Package includes Summit® 3000 floor scale, 120/120 PLUS digital weight indicator with tilt stand, 20 ft load cell cable with quick disconnect, configured and calibrated				
115 VAC (120)				
78772	4 ft x 4 ft x 3.625 in	5,000 lb x 1 lb	315 lb	\$1,475.00
78773	4 ft x 4 ft x 3.625 in	10,000 lb x 2 lb	315 lb	1,475.00
115 VAC (120 PLUS)				
106913	4 ft x 4 ft x 3.625 in	5,000 lb x 1 lb	315 lb	1,625.00
106914	4 ft x 4 ft x 3.625 in	10,000 lb x 2 lb	315 lb	1,625.00
230 VAC (120)				
78780	4 ft x 4 ft x 3.625 in	5,000 lb x 1 lb	315 lb	1,475.00
78781	4 ft x 4 ft x 3.625 in	10,000 lb x 2 lb	315 lb	1,475.00
230 VAC (120 PLUS)				
106915	4 ft x 4 ft x 3.625 in	5,000 lb x 1 lb	315 lb	1,625.00
106916	4 ft x 4 ft x 3.625 in	10,000 lb x 2 lb	315 lb	1,625.00
115 VAC Canadian Weights and Measures (120)				
78776	4 ft x 4 ft x 3.625 in	2,500 kg x 0.5 kg	315 lb	1,475.00
78777	4 ft x 4 ft x 3.625 in	5,000 kg x 1 kg	315 lb	1,475.00
115 VAC Canadian Weights and Measures (120 PLUS)				
106917	4 ft x 4 ft x 3.625 in	2,500 kg x 0.5 kg	315 lb	1,625.00
106918	4 ft x 4 ft x 3.625 in	5,000 kg x 1 kg	315 lb	1,625.00
<b>Floor Scale and Indicator Package (5-Scale Package)</b>				
Packages include five Summit® 3000 floor scales, five 120/120 PLUS digital weight indicators with tilt stands, five 20 ft load cell cables with quick disconnect, configured and calibrated				
115 VAC (120)				
78774	4 ft x 4 ft x 3.625 in	5,000 lb x 1 lb	1665 lb	7,075.00
78775	4 ft x 4 ft x 3.625 in	10,000 lb x 2 lb	1665 lb	7,075.00
115 VAC (120 PLUS)				
106929	4 ft x 4 ft x 3.625 in	5,000 lb x 1 lb	1665 lb	7,825.00
106930	4 ft x 4 ft x 3.625 in	10,000 lb x 2 lb	1665 lb	7,825.00
230 VAC (120)				
78782	4 ft x 4 ft x 3.625 in	5,000 lb x 1 lb	1665 lb	7,075.00
78783	4 ft x 4 ft x 3.625 in	10,000 lb x 2 lb	1665 lb	7,075.00
230 VAC (120 PLUS)				
106931	4 ft x 4 ft x 3.625 in	5,000 lb x 1 lb	1665 lb	7,825.00
106932	4 ft x 4 ft x 3.625 in	10,000 lb x 2 lb	1665 lb	7,825.00
115 VAC Canadian Weights and Measures (120)				
78778	4 ft x 4 ft x 3.625 in	2,500 kg x 0.5 kg	1665 lb	7,075.00
78779	4 ft x 4 ft x 3.625 in	5,000 kg x 1 kg	1665 lb	7,075.00
115 VAC Canadian Weights and Measures (120 PLUS)				
106933	4 ft x 4 ft x 3.625 in	2,500 kg x 0.5 kg	1665 lb	7,825.00
106934	4 ft x 4 ft x 3.625 in	5,000 kg x 1 kg	1665 lb	7,825.00

## Options/Accessories

PART #	DESCRIPTION	PRICE
<b>Summit® 3000 Floor Scale</b>		
75819	Floor anchor plates, mild steel (set of two)	\$25.00
76012	Additional operating manual	10.00
<b>120 Digital Weight Indicator</b>		
77925	Revolution® Scale Software*	35.00
78611	Additional power supply, 115VAC	25.00
76699	Additional operating manual	30.00

\* Revolution® III can be downloaded for free from the distributor section of our website at [www.ricelake.com](http://www.ricelake.com)

Access ramps, pit frames, bumper guards and portability frames available, see end of section for details

# Summit® 3000

Low-Profile Floor Scale

## Specifications

### End Load Capacity:

- 100% full scale at 2,000 lb and 5,000 lb
- 80% full scale at 10,000 lb

### Cable Length:

- 20 ft (6.1 m) (for connecting junction box to indicator)

### Warranty:

- Summit 3000 weldment and load cells two years, all other components one year

### Approvals:

- NTEP CC 92-001A9, Class III 5,000d
- Measurement Canada AM-5530, Class III 5,000d

## Standard Features

- Four NTEP Certified alloy steel shear beam load cells
- Top access junction box
- Rugged diamond safety tread plate steel deck
- Four adjustable rigid polyurethane rubber feet, 3 in (76.2 mm) diameter
- Signal trim summing board housed in ABS enclosure
- Threaded eyebolt hole (1/2–20NF) located in center of the deck for easy lifting
- 20 ft of EL147 load cell cable



## APPROVALS



Measurement  
Canada  
Approved



*The load cell cable exits weldment toward the interior of scale, allowing flexibility to route it out any side of scale to digital weight indicator.*

# Summit® 3000

Low-Profile Floor Scale

## Part Number/Price

PART #	SIZE (W X L X H)*	CAPACITY	EST. SHIP WEIGHT	PRICE
<b>Single Scale</b>				
74715	3 ft x 3 ft x 3.625 in	2,000 lb	190 lb	\$1,150.00
74716	4 ft x 4 ft x 3.625 in	2,000 lb	305 lb	1,250.00
74717	4 ft x 4 ft x 3.625 in	5,000 lb	305 lb	1,250.00
74718	4 ft x 4 ft x 3.625 in	10,000 lb	305 lb	1,250.00
74719	4 ft x 5 ft x 3.625 in	5,000 lb	395 lb	1,350.00
74720	4 ft x 5 ft x 3.625 in	10,000 lb	445 lb	1,530.00
74721	4 ft x 6 ft x 3.625 in	5,000 lb	470 lb	1,440.00
74722	4 ft x 6 ft x 3.625 in	10,000 lb	525 lb	1,715.00
74723	5 ft x 5 ft x 3.625 in	5,000 lb	505 lb	1,455.00
74724	5 ft x 5 ft x 3.625 in	10,000 lb	575 lb	1,760.00
<b>Single Scale—Canadian Weights and Measures Certified</b>				
77440	3 ft x 3 ft x 3.625 in	1,000 kg	190 lb	1,150.00
77373	4 ft x 4 ft x 3.625 in	1,000 kg	305 lb	1,250.00
77346	4 ft x 4 ft x 3.625 in	2,500 kg	305 lb	1,250.00
77347	4 ft x 4 ft x 3.625 in	5,000 kg	305 lb	1,250.00
82880	4 ft x 5 ft x 3.625 in	2,500 kg	395 lb	1,350.00
82881	4 ft x 5 ft x 3.625 in	5,000 kg	445 lb	1,530.00
77348	5 ft x 5 ft x 3.625 in	2,500 kg	505 lb	1,455.00
77349	5 ft x 5 ft x 3.625 in	5,000 kg	575 lb	1,760.00
<b>5-Scale Package</b>				
75809	3 ft x 3 ft x 3.625 in	2,000 lb	850 lb	5,500.00
75810	4 ft x 4 ft x 3.625 in	2,000 lb	1,400 lb	6,000.00
75811	4 ft x 4 ft x 3.625 in	5,000 lb	1,400 lb	6,000.00
75812	4 ft x 4 ft x 3.625 in	10,000 lb	1,400 lb	6,000.00
75813	4 ft x 5 ft x 3.625 in	5,000 lb	1,870 lb	6,500.00
75814	4 ft x 5 ft x 3.625 in	10,000 lb	2,115 lb	7,400.00
75815	4 ft x 6 ft x 3.625 in	5,000 lb	2,210 lb	6,950.00
75816	4 ft x 6 ft x 3.625 in	10,000 lb	2,495 lb	8,325.00
75817	5 ft x 5 ft x 3.625 in	5,000 lb	2,325 lb	7,025.00
75818	5 ft x 5 ft x 3.625 in	10,000 lb	2,675 lb	8,550.00
<b>5-Scale—Canadian Weights and Measures Certified</b>				
77472	3 ft x 3 ft x 3.625 in	1,000 kg	850 lb	5,500.00
77473	4 ft x 4 ft x 3.625 in	1,000 kg	1,400 lb	6,000.00
77474	4 ft x 4 ft x 3.625 in	2,500 kg	1,400 lb	6,000.00
77475	4 ft x 4 ft x 3.625 in	5,000 kg	1,400 lb	6,000.00
82885	4 ft x 5 ft x 3.625 in	2,500 kg	1,870 lb	6,500.00
82886	4 ft x 5 ft x 3.625 in	5,000 kg	2,115 lb	7,400.00
77476	5 ft x 5 ft x 3.625 in	2,500 kg	2,325 lb	7,025.00
77477	5 ft x 5 ft x 3.625 in	5,000 kg	2,675 lb	8,550.00

## Options/Accessories

PART #	DESCRIPTION	EST. SHIP WEIGHT	PRICE
75819	Floor anchor plates, mild steel (set of two)	—	\$25.00
Consult	Top access foot adjust holes	—	40.00

\* For custom sizes or capacities please consult factory for RoughDeck® HP pricing

\*\* For use with DC-190 counting scales \*\*\*Not recommended for use with pallet jacks

# Floor Scale

Access Ramps



## RoughDeck

PART #	SIZE (W X †L X H)	EST. SHIP WEIGHT	PRICE
<b>RoughDeck HP: 1,000 lb–10,000 lb</b>			
69040*	2.5 ft x 3 ft x 3.5 in	115 lb	\$310.00
69041*	3 ft x 3 ft x 3.5 in	133 lb	330.00
69042*	4 ft x 3 ft x 3.5 in	177 lb	360.00
69043*	5 ft x 3 ft x 3.5 in	226 lb	410.00
69184	2.5 ft x 4 ft x 3.5 in	152 lb	360.00
69185	3 ft x 4 ft x 3.5 in	177 lb	385.00
69186	4 ft x 4 ft x 3.5 in	224 lb	430.00
69187	5 ft x 4 ft x 3.5 in	272 lb	460.00
<b>RoughDeck HP-H: 20,000 lb</b>			
69204	4 ft x 4 ft x 4 in	487 lb	765.00
69205	5 ft x 4 ft x 4 in	591 lb	870.00
69206	6 ft x 4 ft x 4 in	689 lb	920.00
69207	7 ft x 4 ft x 4 in	822 lb	1,065.00
69208	8 ft x 4 ft x 4 in	1005 lb	1,180.00
<b>RoughDeck HP-H: 30,000 lb</b>			
69210	4 ft x 5 ft x 5 in	666 lb	945.00
69211	5 ft x 5 ft x 5 in	806 lb	1,050.00
69212	6 ft x 5 ft x 5 in	942 lb	1,150.00
69213	7 ft x 5 ft x 5 in	1116 lb	1,305.00
69214	8 ft x 5 ft x 5 in	1337 lb	1,510.00
<b>RoughDeck SS and HE: 1,000 lb–10,000 lb</b>			
69178*	2.5 ft x 3 ft x 3.5 in	115 lb	945.00
69179*	3 ft x 3 ft x 3.5 in	133 lb	945.00
69180*	4 ft x 3 ft x 3.5 in	177 lb	1,155.00
69189	2.5 ft x 4 ft x 3.5 in	152 lb	1,050.00
69190	3 ft x 4 ft x 3.5 in	177 lb	1,155.00
69191	4 ft x 4 ft x 3.5 in	224 lb	1,570.00
69192	5 ft x 4 ft x 3.5 in	272 lb	1,770.00

## Summit

PART #	SIZE (W X †L X H)	EST. SHIP WEIGHT	PRICE
74953*	3 ft x 3 ft x 3.625 in	133 lb	330.00
74954*	4 ft x 3 ft x 3.625 in	177 lb	360.00
74955*	5 ft x 3 ft x 3.625 in	226 lb	410.00
74956	3 ft x 4 ft x 3.625 in	177 lb	385.00
74957	4 ft x 4 ft x 3.625 in	224 lb	430.00
74958	5 ft x 4 ft x 3.625 in	272 lb	460.00

\* Not recommended for use with pallet jacks

† Approach length (must match width of ramp with width of scale)

NOTE: Part numbered ramps are designed to fit scale on sides perpendicular to junction box. The junction box is always on longest side of scale unless specified differently.

# Floor Scale

Pit Frames

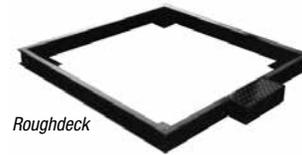

RoughDeck

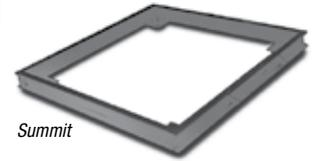

Summit

## RoughDeck

PART #	SIZE (W X L)	EST. SHIP WEIGHT	PRICE
<b>RoughDeck HP: 1,000 lb–10,000 lb</b>			
18757	2.5 ft x 2.5 ft	88 lb	\$285.00
18759	3 ft x 3 ft	102 lb	315.00
18761	4 ft x 4 ft	127 lb	405.00
18763	5 ft x 5 ft	154 lb	500.00
18765	4 ft x 5 ft	140 lb	455.00
18767	4 ft x 6 ft	157 lb	500.00
18769	5 ft x 6 ft	172 lb	550.00
18771	5 ft x 7 ft	185 lb	590.00
<b>RoughDeck HP-H: 20,000 lb</b>			
39595	4 ft x 4 ft	309 lb	495.00
39596	4 ft x 5 ft	352 lb	530.00
39597	4 ft x 6 ft	391 lb	575.00
39598	4 ft x 7 ft	459 lb	655.00
39599	5 ft x 5 ft	411 lb	600.00
39600	5 ft x 6 ft	460 lb	685.00
39601	5 ft x 7 ft	473 lb	715.00
39602	6 ft x 6 ft	583 lb	795.00
39603	6 ft x 7 ft	597 lb	825.00
39604	6 ft x 8 ft	610 lb	870.00
39605	7 ft x 9 ft	683 lb	925.00
39606	7 ft x 10 ft	781 lb	975.00
39607	8 ft x 10 ft	795 lb	1,015.00
<b>RoughDeck HP-H: 30,000 lb</b>			
39608	4 ft x 4 ft	356 lb	590.00
39609	4 ft x 5 ft	402 lb	620.00
39610	4 ft x 6 ft	444 lb	675.00
39611	4 ft x 7 ft	516 lb	745.00
39612	5 ft x 5 ft	464 lb	715.00
39613	5 ft x 6 ft	498 lb	755.00
39614	5 ft x 7 ft	533 lb	795.00
39615	6 ft x 6 ft	643 lb	920.00
39619	7 ft x 10 ft	850 lb	1,025.00
39620	8 ft x 10 ft	875 lb	1,065.00
<b>RoughDeck SS and HE: 1,000 lb - 10,000 lb</b>			
18758	2.5 ft x 2.5 ft	88 lb	910.00
18760	3 ft x 3 ft	102 lb	910.00
18762	4 ft x 4 ft	127 lb	1,210.00
18764	5 ft x 5 ft	154 lb	1,500.00
18766	4 ft x 5 ft	140 lb	1,355.00
18772	5 ft x 7 ft	185 lb	1,785.00

## Summit

PART #	SIZE (W X L)	EST. SHIP WEIGHT	PRICE
75036	3 ft x 3 ft	100 lb	\$315.00
75037	4 ft x 4 ft	125 lb	405.00
75040	5 ft x 5 ft	155 lb	500.00
75038	4 ft x 5 ft	140 lb	455.00
75039	4 ft x 6 ft	157 lb	500.00

# Bumper Guards

Option A

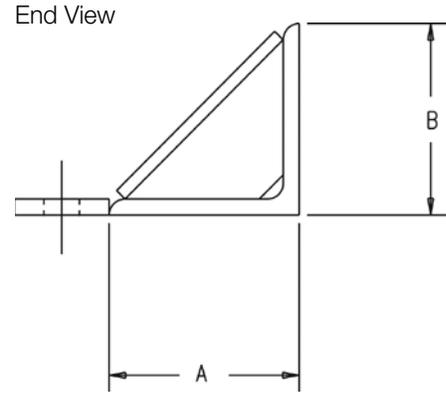
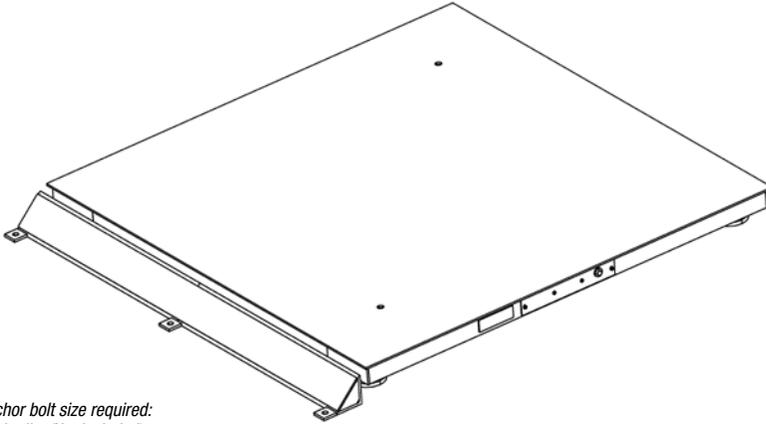

Anchor bolt size required:  
1/2 in dia. (Not Included)

Construction:  
RoughDeck® HP & HP-H versions  
(Mild steel, painted safety yellow)  
RoughDeck SS/HE  
(304 stainless steel)

DRAWING DIMENSIONS		
Model	A	B
RoughDeck HP	3 in	3 in
RoughDeck SS/HE	3 in	3 in
RoughDeck HP-H	4 in	4 in

## Part Number/Price

LENGTH	ROUGHDECK HP	PRICE EACH	ROUGHDECK SS/HE	PRICE EACH	ROUGHDECK HP-H	PRICE EACH
2.5 ft	86815	\$125.00	86824	\$215.00	86833	\$215.00
3.0 ft	86816	150.00	86825	255.00	86834	255.00
4.0 ft	86817	200.00	86826	340.00	86835	340.00
5.0 ft	86818	250.00	86827	425.00	86836	425.00
6.0 ft	86819	300.00	86828	510.00	86837	510.00
7.0 ft	86820	350.00	86829	595.00	86838	595.00
8.0 ft	86821	400.00	86830	680.00	86839	680.00
9.0 ft	86822	450.00	86831	765.00	86840	765.00
10.0 ft	86823	500.00	86832	850.00	86841	850.00

## Accessories

PART #	DESCRIPTION	PRICE
18777	Floor anchor plates, mild steel (set of two), RoughDeck HP	\$30.00
18778	Floor anchor plates, stainless steel (set of two), RoughDeck SS/HE	32.00
40387	Floor anchor plates, mild steel (set of two), RoughDeck HP-H 20k	42.00
40388	Floor anchor plates, mild steel (set of two), RoughDeck HP-H 30k	42.00

# Bumper Guards

## Option B

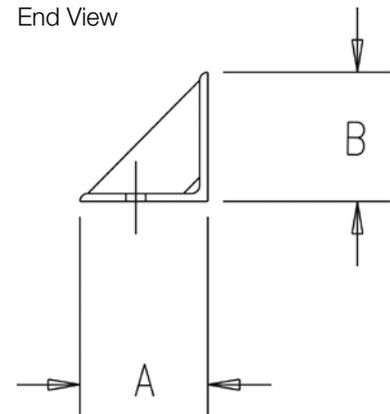
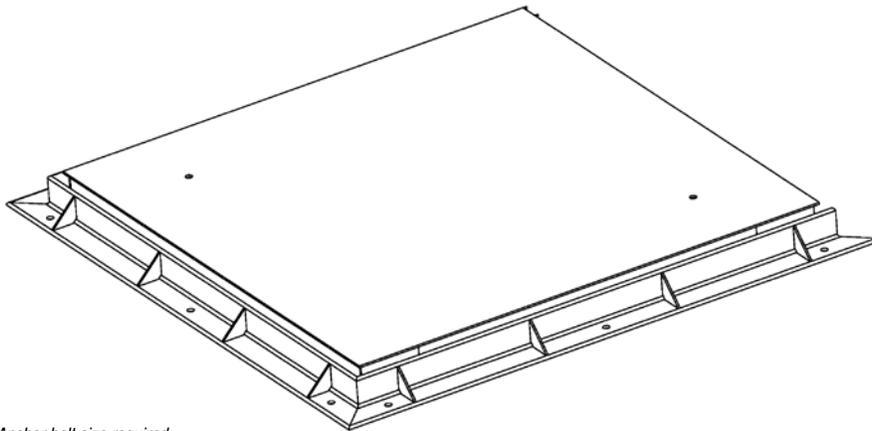

Anchor bolt size required:  
1/2 in dia. (Not Included)

Construction:  
RoughDeck® HP & HP-H versions  
(Mild steel, Painted safety yellow)

RoughDeck SS/HE  
(304 stainless steel)

Note: If you plan to surround scale on all four sides with bumper guards, option B, please contact factory as a special bumper guard must be made to accommodate the home run cable exit.

### DRAWING DIMENSIONS

Model	A	B
RoughDeck HP	3 in	3 in
RoughDeck SS/HE	3 in	3 in
RoughDeck HP-H	4 in	4 in

### Part Number/Price

LENGTH	ROUGHDECK HP	PRICE EACH	ROUGHDECK SS/HE	PRICE EACH	ROUGHDECK HP-H	PRICE EACH
2.5 ft	86843	\$120.00	86852	\$175.00	86861	\$175.00
3.0 ft	86844	145.00	86853	210.00	86862	210.00
4.0 ft	86845	195.00	86854	280.00	86863	280.00
5.0 ft	86846	240.00	86855	350.00	86864	350.00
6.0 ft	86847	290.00	86856	420.00	86865	420.00
7.0 ft	86848	340.00	86857	490.00	86866	490.00
8.0 ft	86849	385.00	86858	560.00	86867	560.00
9.0 ft	86850	435.00	86859	630.00	86868	630.00
10.0 ft	86851	480.00	86860	700.00	86869	700.00

### Accessories

PART #	DESCRIPTION	PRICE
18777	Floor anchor plates, mild steel (set of two), RoughDeck HP	\$30.00
18778	Floor anchor plates, stainless steel (set of two), RoughDeck SS/HE	32.00
40387	Floor anchor plates, mild steel (set of two), RoughDeck HP-H 20k	42.00
40388	Floor anchor plates, mild steel (set of two), RoughDeck HP-H 30k	42.00

# Bumper Guards

Option C

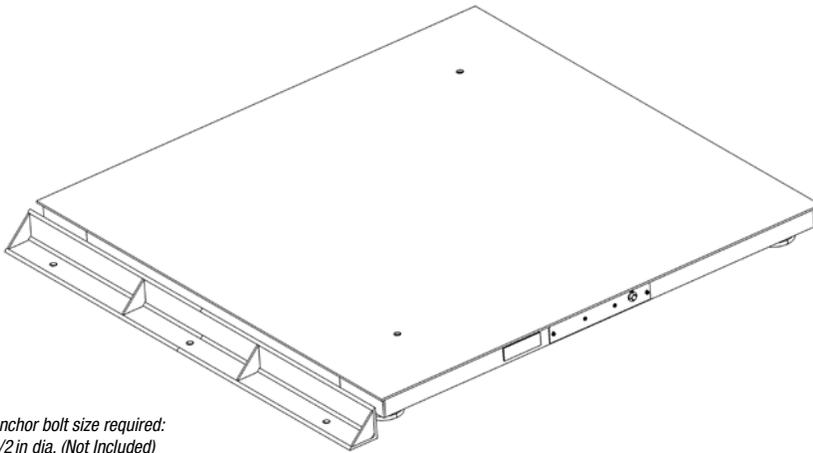

End View

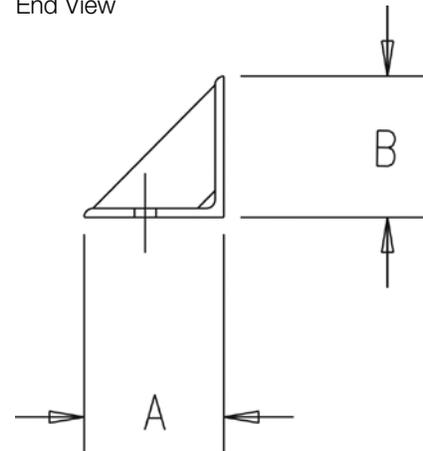

Anchor bolt size required:  
1/2 in dia. (Not Included)

Construction:  
RoughDeck® HP & HP-H versions  
(Mild steel, Painted safety yellow)

RoughDeck SS/HE  
(304 stainless steel)

DRAWING DIMENSIONS		
Model	A	B
RoughDeck HP	3 in	3 in
RoughDeck SS/HE	3 in	3 in
RoughDeck HP-H	4 in	4 in

## Part Number/Price

LENGTH	ROUGHDECK HP	PRICE EACH	ROUGHDECK SS/HE	PRICE EACH	ROUGHDECK HP-H	PRICE EACH
2.5 ft	86870	\$80.00	86879	\$155.00	86888	\$155.00
3.0 ft	86871	100.00	86880	190.00	86889	190.00
4.0 ft	86872	130.00	86881	250.00	86890	250.00
5.0 ft	86873	160.00	86882	310.00	86891	310.00
6.0 ft	86874	195.00	86883	375.00	86892	375.00
7.0 ft	86875	225.00	86884	435.00	86893	435.00
8.0 ft	86876	260.00	86885	500.00	86894	500.00
9.0 ft	86877	290.00	86886	560.00	86895	560.00
10.0 ft	86878	320.00	86887	620.00	86896	620.00

## Accessories

PART #	DESCRIPTION	PRICE
18777	Floor anchor plates, mild steel (set of two), RoughDeck HP	\$30.00
18778	Floor anchor plates, stainless steel (set of two), RoughDeck SS/HE	32.00
40387	Floor anchor plates, mild steel (set of two), RoughDeck HP-H 20k	42.00
40388	Floor anchor plates, mild steel (set of two), RoughDeck HP-H 30k	42.00



# RoughDeck® HP and SS

Portability Frames

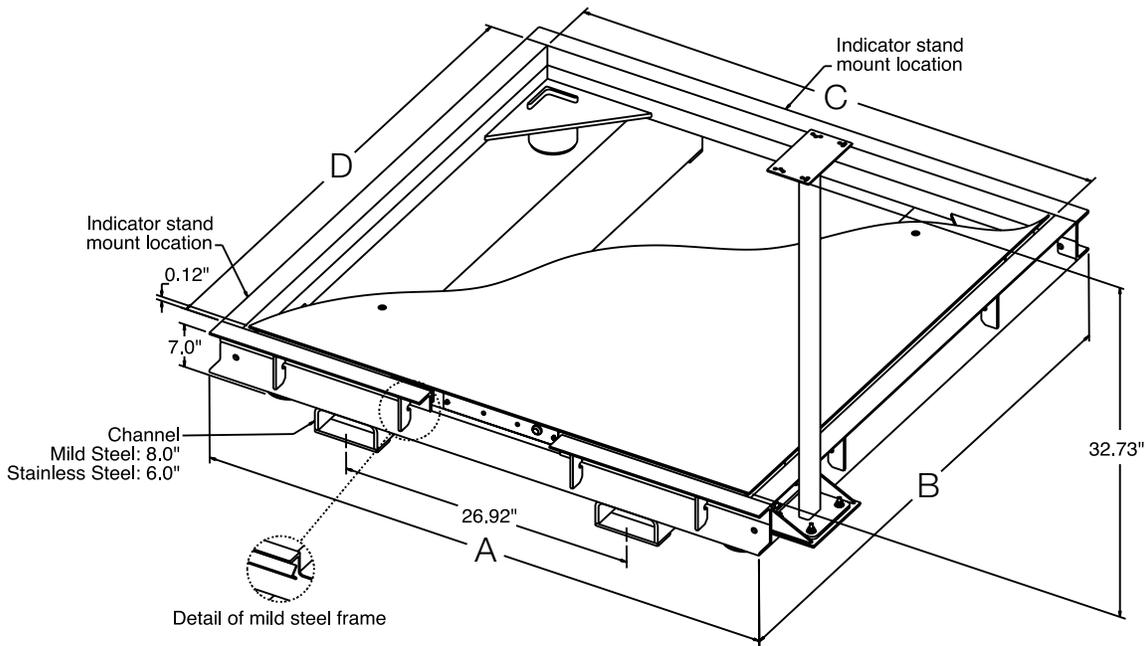

PORTABILITY FRAME DIMENSIONS		
<b>4 ft x 4 ft</b>		
A	Mild Steel: 51.92 in (1318 mm)	Stainless Steel: 52.75 in (1339 mm)
B	Mild Steel: 51.92 in (1318 mm)	Stainless Steel: 52.75 in (1339 mm)
C	48.75 in (1238 mm)	
D	48.75 in (1238 mm)	
<b>5 ft x 5 ft</b>		
A	63.92 in (1623 mm) Mild Steel	64.75 in (1644 mm) Stainless Steel
B	63.92 in (1623 mm) mild steel	64.75 in (1644 mm) stainless steel
C	60.75 in (1543 mm)	
D	60.75 in (1543 mm)	
<b>Distance from floor to inside of strap on the fork entry</b>		
	Mild Steel: 3/4 in	Stainless Steel: 1/2 in
<b>Distance from inside of strap to top of the fork entry</b>		
	Mild Steel: 2 in	Stainless Steel: 2 1/4 in

## Part Number/Price

PART #	SIZE (W X L)	EST. SHIP WEIGHT	PRICE
<b>RoughDeck HP Portability Frames</b>			
164492	4 ft x 4 ft, up to 10K capacity, floor stand for indicator 36.3 inches high, indicator stand mounting bracket		\$945.00
164493	5 ft x 5 ft, up to 10K capacity, floor stand for indicator 36.3 inches high, indicator stand mounting bracket		1,040.00
<b>RoughDeck SS Portability Frames</b>			
164494	4 ft x 4 ft, up to 10K capacity, floor stand for indicator 36.3 inches high, indicator stand mounting bracket		2,575.00
164495	5 ft x 5 ft, up to 10K capacity, floor stand for indicator 36.3 inches high, indicator stand mounting bracket		2,875.00

\* Works with 480, IQ plus 390 DC, 480, IQ plus 590 DC

† Floor stand for indicator is not included with frames.

NOTE: Consult factory if you intend on using with a pallet jack to confirm modifications are not required.

# RoughDeck® HP Caster

Portability Frames

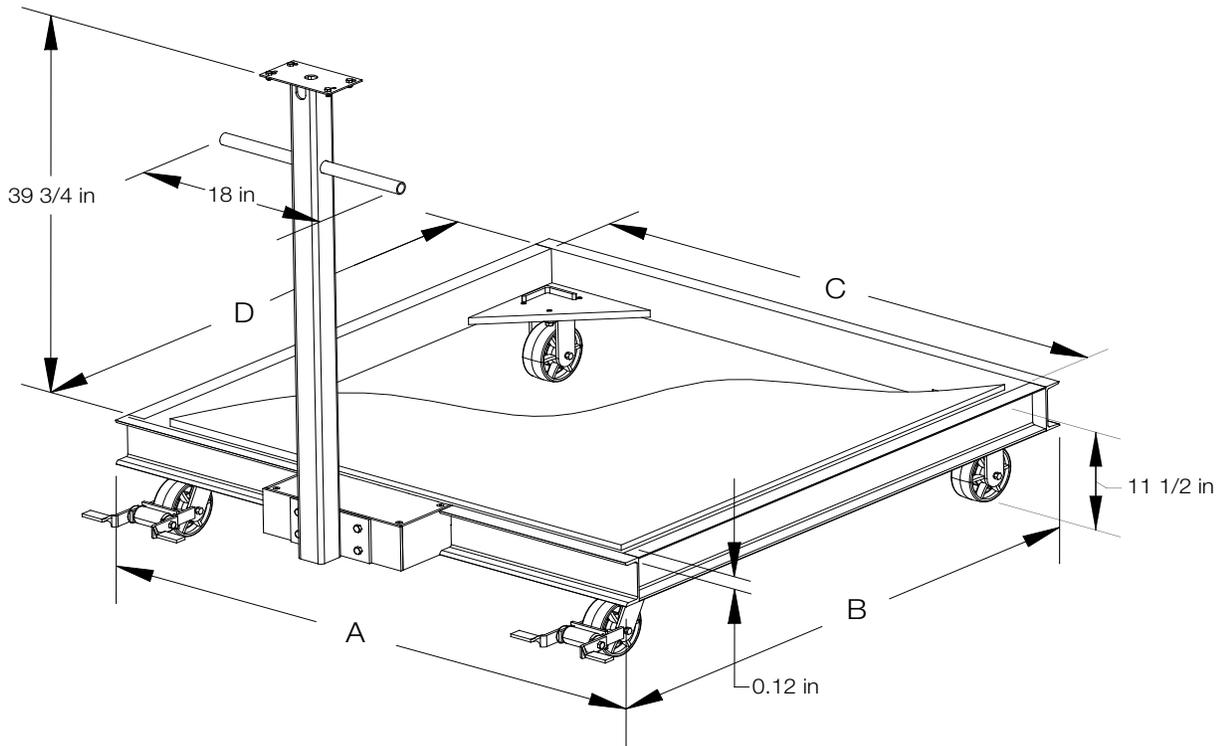

## Standard Features

- Painted mild steel
- Indicator stand fits IP +355, IQ +390, 420 Plus, IQ +590 and 480 Legend
- Two rigid forged steel casters, two swivel forged steel caster with lock on back
- Casters for scales 1 k-5 k are rated for 1500 pounds each. Casters for 10 k scale are rated for 4000 pounds each

## Part Number/Price

PART #	SIZE (W X L X H)	EST. SHIP WEIGHT	PRICE
<b>RoughDeck HP Caster Portability Frames</b>			
157785	2.5 x 2.5 ft, for RoughDeck HP 1 k to 5 k	220 lb	\$1,695.00
157791	3 x 3 ft, for RoughDeck HP 1 k to 5 k	240 lb	1,695.00
157792	4 x 4 ft, for RoughDeck HP 1 k to 5 k	260 lb	1,695.00
157793	4 x 4 ft, for RoughDeck HP 10k	260 lb	1,895.00

## CASTER PORTABILITY FRAME DIMENSIONS

2.5 ft x 2.5 ft (1 K-5 K)	
A	33.92
B	33.92
C	30.75
D	30.75
3 ft x 3 ft (1 K-5 K)	
A	39.92
B	39.92
C	36.75
D	36.75
4 ft x 4 ft (1 K-5 K)	
A	51.92
B	51.92
C	48.75
D	48.75
4 ft x 4 ft (10 K)	
A	51.92
B	51.92
C	48.75
D	48.75

# RoughDeck® HP, SS & HE

## Pit Frame Concrete Details\*

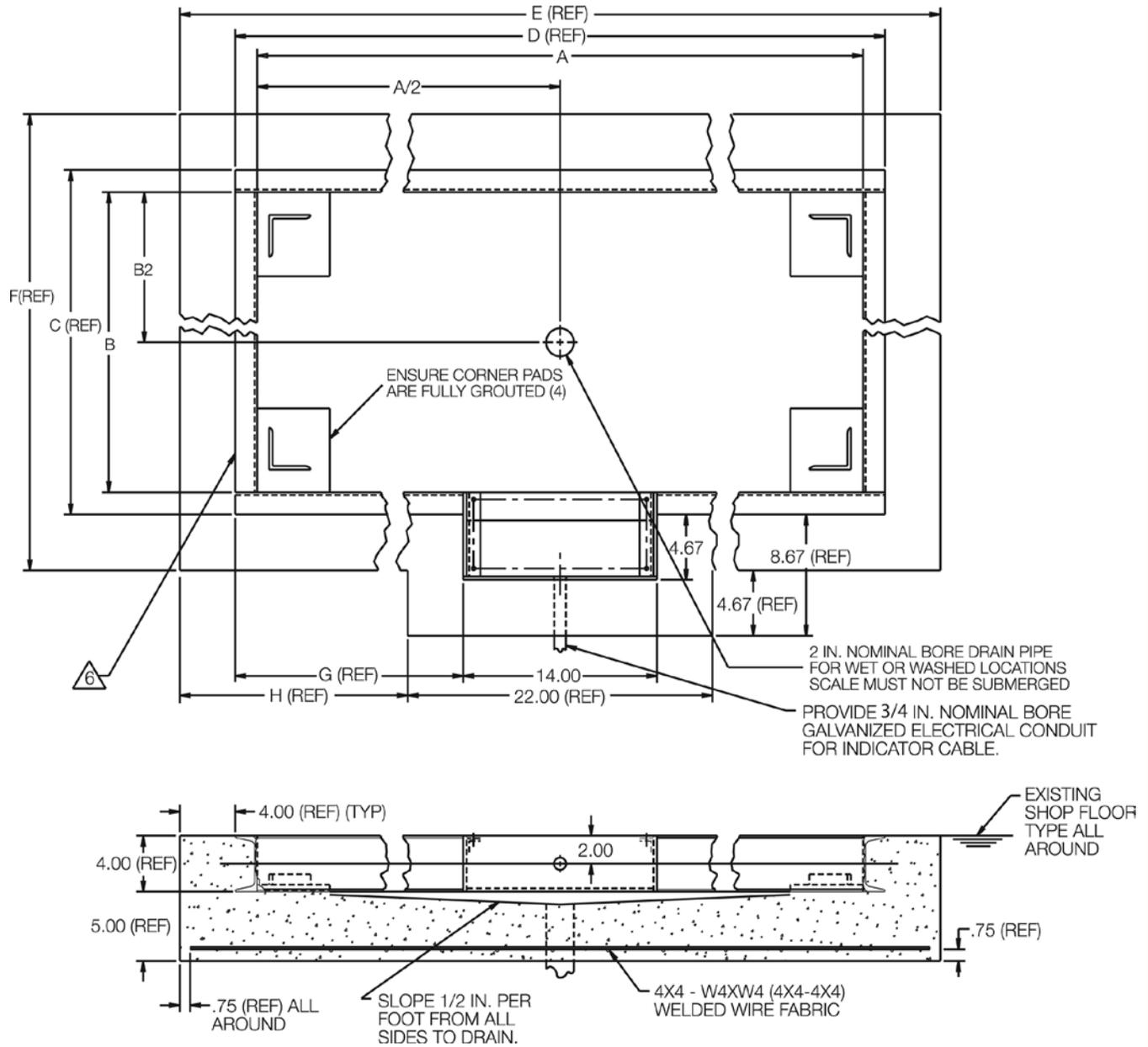

1. Use concrete of minimum yield strength 5,000 PSI or six-bag mix
  2. Allow seven days to cure (wet concrete periodically during this time).
  3. Dimensions shown assume firm, stable soil conditions. When soil conditions are not adequate, place foundation at sufficient depth.
  4. In wet or washdown applications, we recommend the use of hermetically sealed load cells, and that junction box be mounted remotely in a dry location.
  5. Wire mesh to have minimum 0.75 in cover bottom and sides.
- ⚠ On stainless steel versions, two pieces of 2 in angle will be substituted for 4 in channel.

DRAWING DIMENSIONS								
Scale Size	2.5 ft x 2.5 ft	3 ft x 3 ft	4 ft x 4 ft	5 ft x 5 ft	4 ft x 5 ft	4 ft x 6 ft	5 ft x 6 ft	5 ft x 7 ft
A	30.75	36.75	48.75	60.75	60.75	72.75	72.75	84.75
B	30.75	36.75	48.75	60.75	48.75	48.75	60.75	60.75
C	33.92	39.92	51.92	63.92	51.92	51.92	63.92	63.92
D	33.92	39.92	51.92	63.92	63.92	75.92	75.92	87.92
E	41.92	47.95	59.92	71.92	71.92	83.92	83.92	95.92
F	41.92	47.95	59.92	71.92	59.92	59.92	71.92	71.92
G	9.96	12.96	18.96	24.96	24.96	30.96	30.96	36.96
H	9.96	12.96	18.96	24.96	24.96	30.96	30.96	36.96

All dimensions are shown in inches. Drawing #S2944-Rev. D

\* Drawings are for standard catalog part numbered scales.

# RoughDeck® HP-H

Pit Frame Concrete Details\* - 20,000lb Capacity

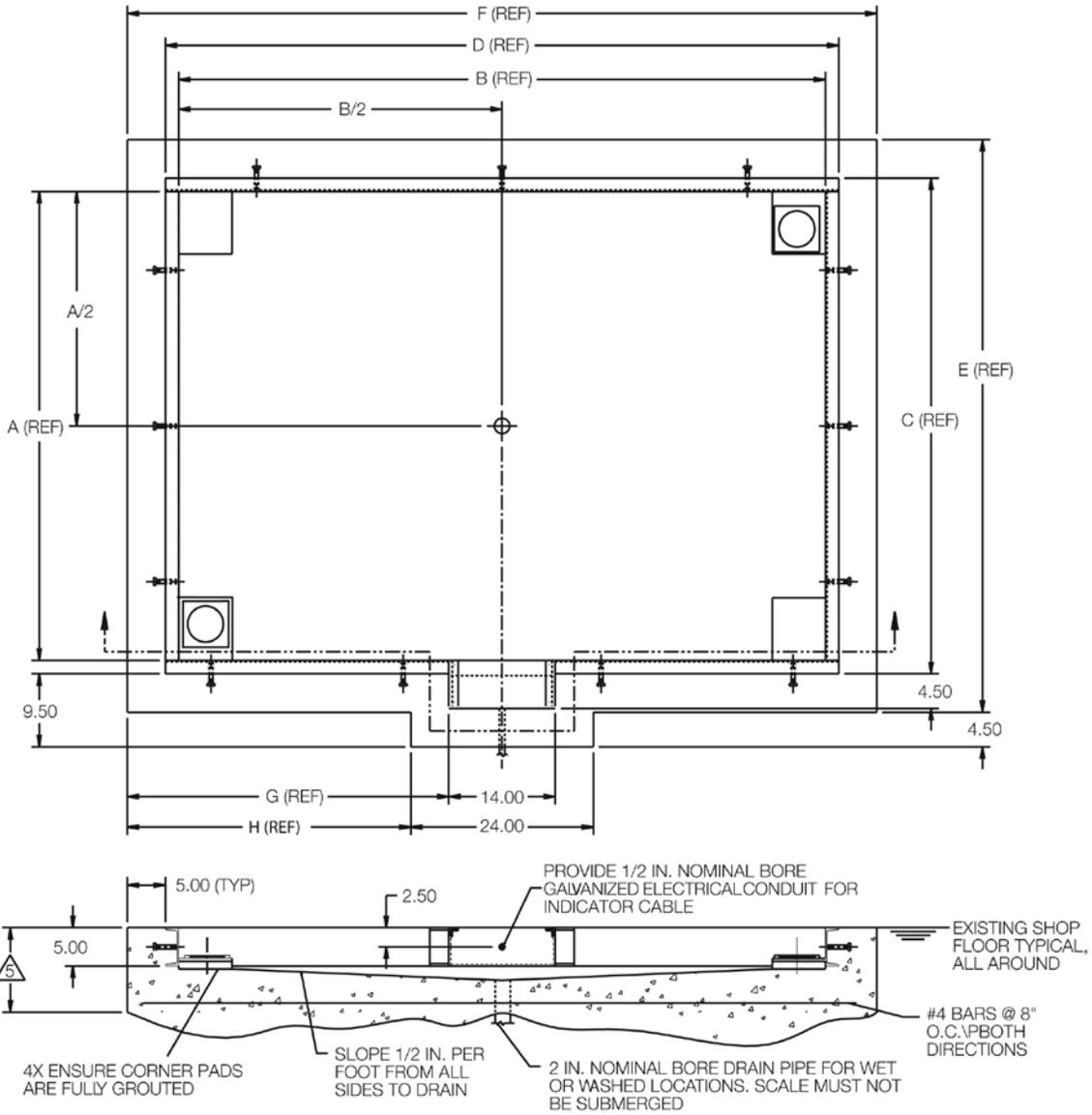

DRAWING DIMENSIONS							
Scale Size	4 ft x 4 ft	4 ft x 5 ft	4 ft x 6 ft	4 ft x 7 ft	5 ft x 5 ft	5 ft x 6 ft	5 ft x 7 ft
A	49.00	49.00	49.00	49.00	61.00	61.00	61.00
B	49.00	61.00	73.00	85.00	61.00	73.00	85.00
C	52.50	52.50	52.50	52.50	64.50	64.50	64.50
D	52.50	64.50	76.50	88.50	64.50	76.50	88.50
E	62.50	62.50	62.50	62.50	74.50	74.50	74.50
F	62.50	74.50	86.50	98.50	74.50	86.50	98.50
G	24.25	30.25	36.25	42.25	30.25	36.25	42.25
H	19.25	25.25	31.35	37.25	25.25	31.35	37.25

DRAWING DIMENSIONS						
Scale Size	6 ft x 6 ft	6 ft x 7 ft	6 ft x 8 ft	7 ft x 9 ft	7 ft x 10 ft	8 ft x 10 ft
A	73.00	73.00	73.00	85.00	85.00	97.00
B	73.00	85.00	97.00	109.00	121.00	121.00
C	76.50	76.50	76.50	88.50	88.50	100.50
D	76.50	88.50	100.50	112.50	124.50	124.50
E	86.50	86.50	86.50	98.50	98.50	110.50
F	86.50	98.50	110.50	122.50	134.50	134.50
G	36.25	42.25	48.25	54.25	60.25	60.25
H	31.25	37.25	43.25	49.25	55.25	55.25

1. Use concrete of minimum yield strength 5,000 PSI or six-bag mix.
2. Allow seven days to cure (wet concrete periodically during this time).
3. Before installing pit frame, ensure that proper sand (or soil) base is available under either existing concrete or new installation.
4. In wet or washdown applications, we recommend use of hermetically sealed load cells, and that junction box be mounted remotely in a dry location.
5. For required depth of slab, or rebar requirements specific to your application, proper engineering consultation is recommended.

All dimensions are shown in inches. Drawing #S2944A-Rev. A  
 \* Drawings are for standard catalog part numbered scales.

# RoughDeck® HP-H

Pit Frame Concrete Details\* - 30,000 lb Capacity

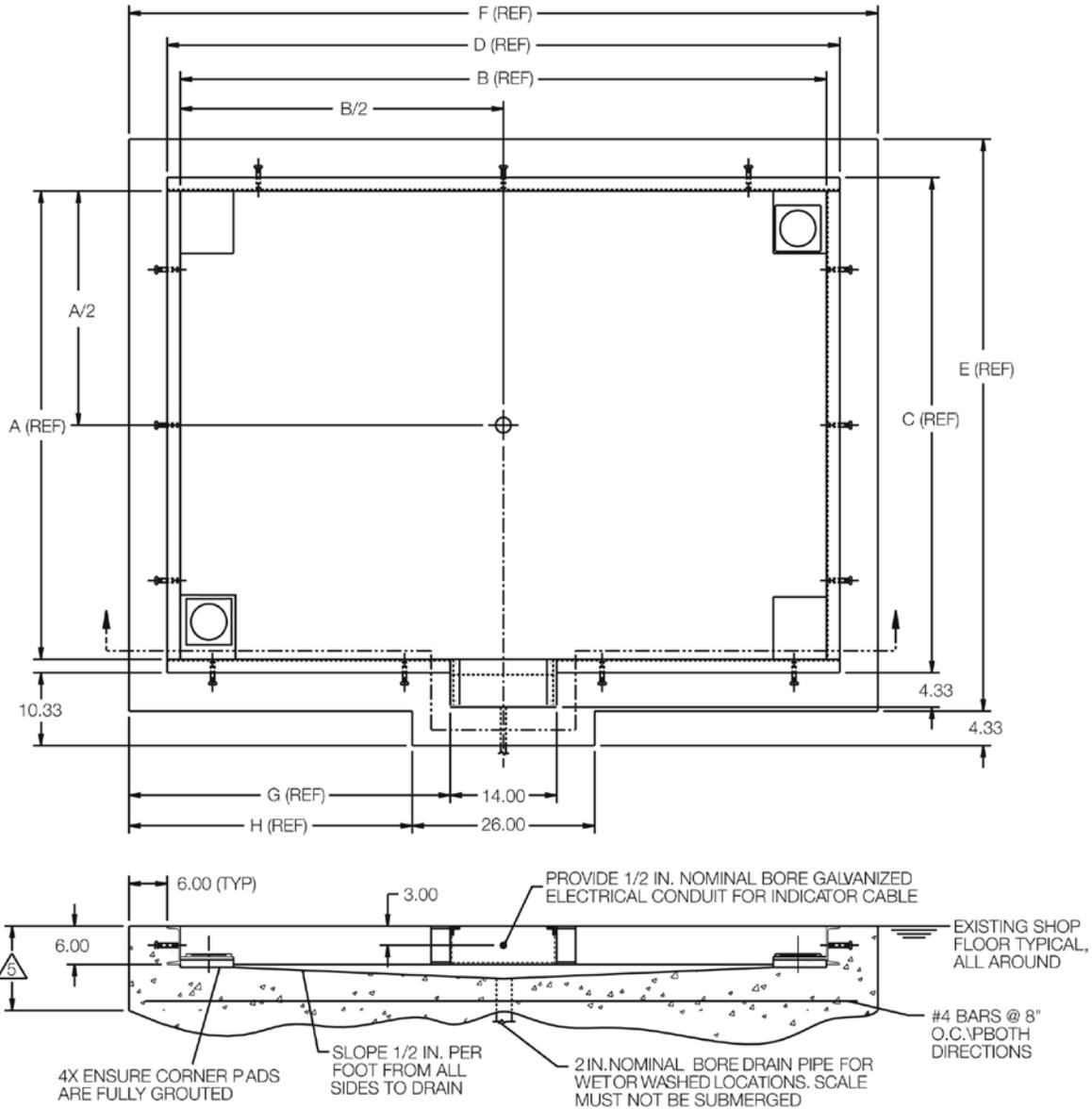

DRAWING DIMENSIONS							
Scale Size	4 ft x 4 ft	4 ft x 5 ft	4 ft x 6 ft	4 ft x 7 ft	5 ft x 5 ft	5 ft x 6 ft	5 ft x 7 ft
A	49.00	49.00	49.00	49.00	61.00	61.00	61.00
B	49.00	61.00	73.00	85.00	61.00	73.00	85.00
C	52.84	52.84	52.84	52.84	64.84	64.84	64.84
D	52.84	64.84	76.84	88.84	64.84	76.84	88.84
E	64.84	64.84	64.84	64.84	76.84	76.84	76.84
F	64.84	76.84	88.84	100.84	76.84	88.84	100.84
G	25.42	31.42	37.42	43.42	31.42	37.42	43.42
H	19.42	25.42	31.42	37.42	25.42	31.42	37.42

DRAWING DIMENSIONS						
Scale Size	6 ft x 6 ft	6 ft x 7 ft	6 ft x 8 ft	7 ft x 9 ft	7 ft x 10 ft	8 ft x 10 ft
A	73.00	73.00	73.00	85.00	85.00	97.00
B	73.00	85.00	97.00	109.00	121.00	121.00
C	76.84	76.84	76.84	88.84	88.84	100.84
D	76.84	88.84	100.84	112.84	124.84	124.84
E	88.84	88.84	88.84	100.84	100.84	112.84
F	88.84	100.84	112.84	112.84	136.84	136.84
G	37.42	43.42	49.42	55.42	61.42	61.42
H	31.42	37.42	43.42	49.42	55.42	55.42

1. Use concrete of minimum yield strength 5,000 PSI or six-bag mix.
  2. Allow seven days to cure (wet concrete periodically during this time).
  3. Before installing pit frame, ensure that proper sand (or soil) base is available under either existing concrete or new installation.
  4. In wet or washdown applications, we recommend the use of hermetically sealed load cells, and that junction box be mounted remotely in a dry location.
- △ For required depth of slab, or rebar requirements specific to your application, proper engineering consultation is recommended.

All dimensions are shown in inches. Drawing #S2944B-Rev. A  
 \* Drawings are for standard catalog part numbered scales.

# AutoLift HE

## Pit Frame Concrete Details\*

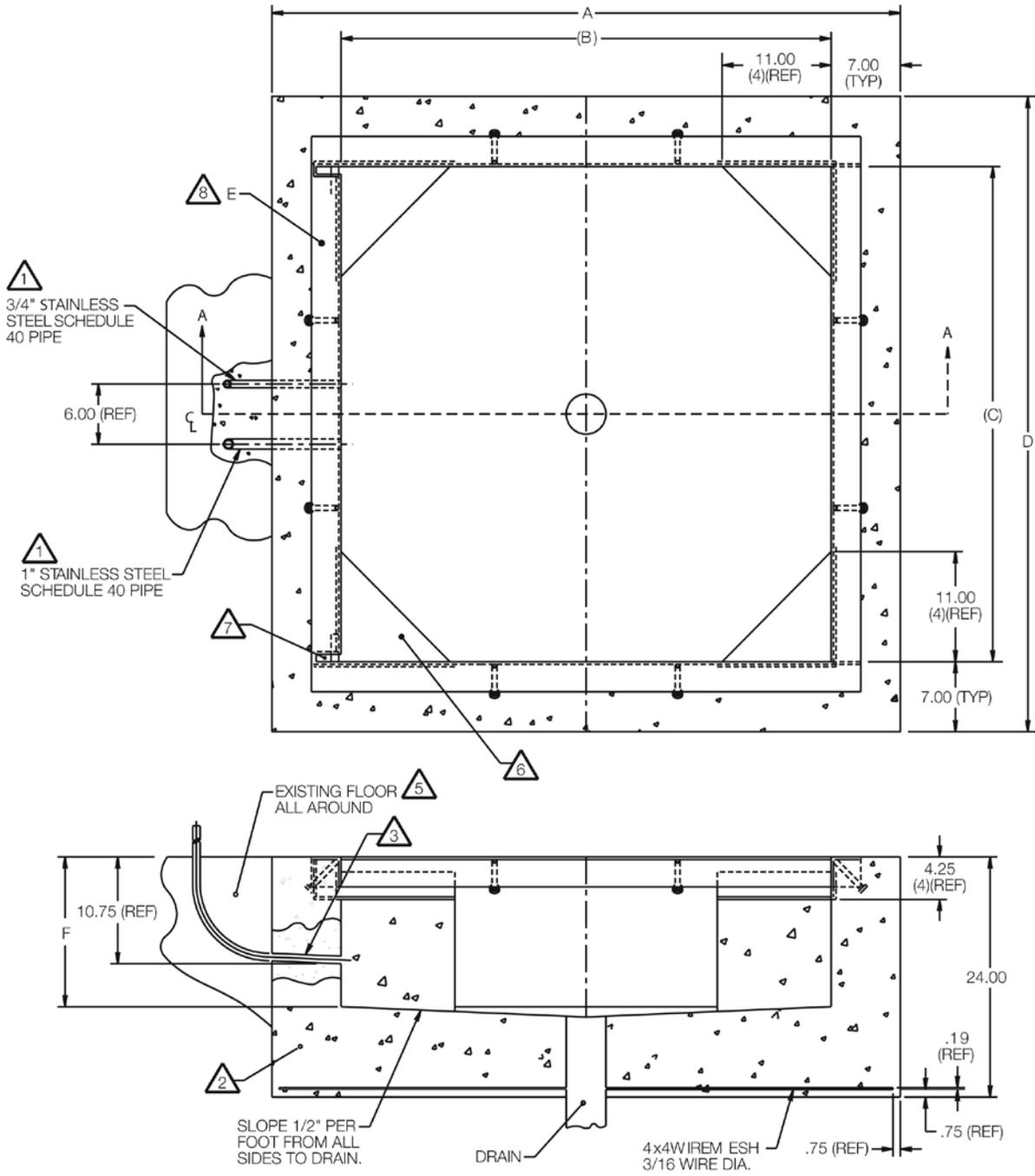

- ① Length of pipe is determined on site.
- ② Use concrete of minimum yield strength 5,000 PSI or six-bag mix.
- ③ Slope pipe slightly for water drainage.
- ④ Allow concrete seven days to cure (wet concrete periodically during this time).
- ⑤ Tie pit in with existing floor with rebar if required.
- ⑥ Ensure underside is supported with concrete or grout (plate is an integral part of frame).
- ⑦ Keep pocket free of concrete.
- ⑧ Coping must sit level in floor to allow proper operation of scale.

DRAWING DIMENSIONS		
Scale Size	4 ft x 4 ft	5 ft x 5 ft
A	63.06	75.06
B	49.06	61.06
C	49.00	61.06
D	63.00	75.00
E (PN)	41936	41397
F	15.00	16.75

All dimensions are shown in inches. Drawing #S5158-Rev. B  
 \* Drawings are for standard catalog part numbered scales.

# RoughDeck® QC

Pit Frame Concrete Details\*

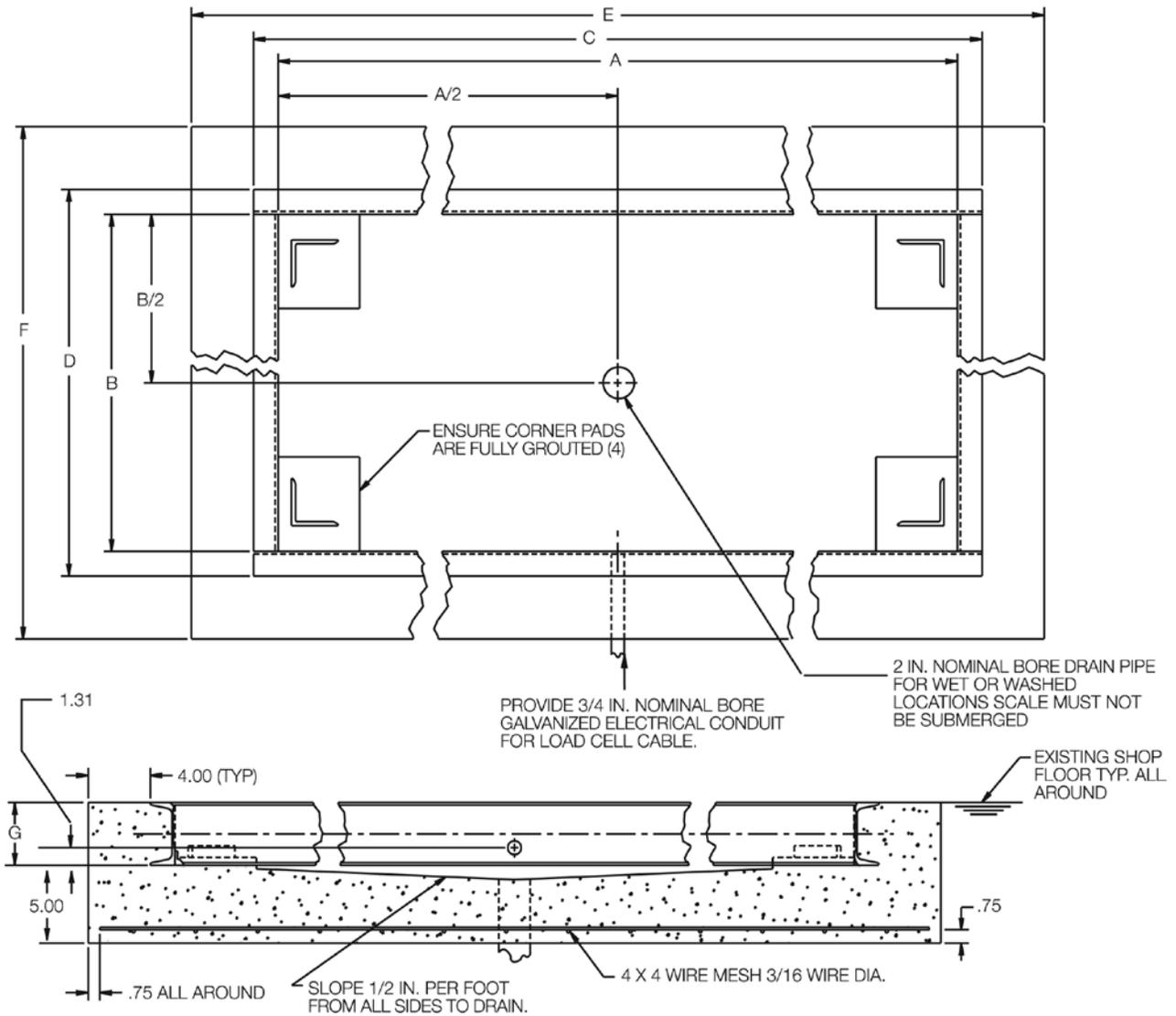

DRAWING DIMENSIONS							
Scale Size	A	B	C	D	E	F	G
2.5 ft x 2.5 ft - 2K	30.75	31.00	34.75	35.00	42.75	43.00	4.00
3 ft x 3 ft - 2K	36.75	37.00	40.75	41.00	48.75	49.00	4.00
4 ft x 4 ft - 2K	48.75	49.00	52.75	53.00	60.75	61.00	4.00
4 ft x 4 ft - 5K	48.75	49.00	52.75	53.00	60.75	61.00	4.00
4 ft x 4 ft - 10K	48.75	49.00	53.75	54.00	61.75	62.00	5.00
4 ft x 5 ft - 2K	60.75	49.00	64.75	53.00	72.75	61.00	4.00
4 ft x 5 ft - 5K	60.75	49.00	65.75	54.00	73.75	62.00	5.00
4 ft x 5 ft - 10K	60.75	49.00	65.75	54.00	73.75	62.00	5.00
4 ft x 6 ft - 2K	72.75	49.00	77.75	54.00	85.75	62.00	5.00

DRAWING DIMENSIONS							
Scale Size	A	B	C	D	E	F	G
4 ft x 6 ft - 5K	72.75	49.00	77.75	54.00	85.75	62.00	5.00
4 ft x 6 ft - 10K	72.75	49.00	78.75	55.00	86.75	63.00	6.00
5 ft x 5 ft - 2K	60.75	61.00	65.75	66.00	73.75	74.00	5.00
5 ft x 5 ft - 5K	60.75	61.00	65.75	66.00	73.75	74.00	5.00
5 ft x 5 ft - 10K	60.75	61.00	65.75	66.00	73.75	74.00	5.00
5 ft x 7 ft - 2K	84.75	61.00	90.75	67.00	98.75	75.00	6.00
5 ft x 7 ft - 5K	84.75	61.00	90.75	67.00	98.75	75.00	6.00
5 ft x 7 ft - 10K	84.75	61.00	90.75	67.00	98.75	75.00	6.00
6 ft x 6 ft - 5K	72.75	73.00	78.75	79.00	86.75	87.00	6.00
6 ft x 6 ft - 10K	72.75	73.00	78.75	79.00	86.75	87.00	6.00

All dimensions are shown in inches. Drawing #S6360A-Rev. D

1. Use concrete of minimum yield strength 5,000 PSI or six-bag mix.
2. Allow seven days to cure (wet concrete periodically during this time).
3. Dimensions shown assume firm, stable soil conditions. When soil conditions are not adequate, place foundation at sufficient depth.
4. In wet or washdown applications, we recommend the use of hermetically-sealed load cells, and that the junction box be mounted remotely in a dry location.
5. Wire mesh to have minimum 0.75 in cover bottom and sides.

\* Drawings are for standard catalog part numbered scales.

# Summit® 3000

## Pit Frame Concrete Details\*

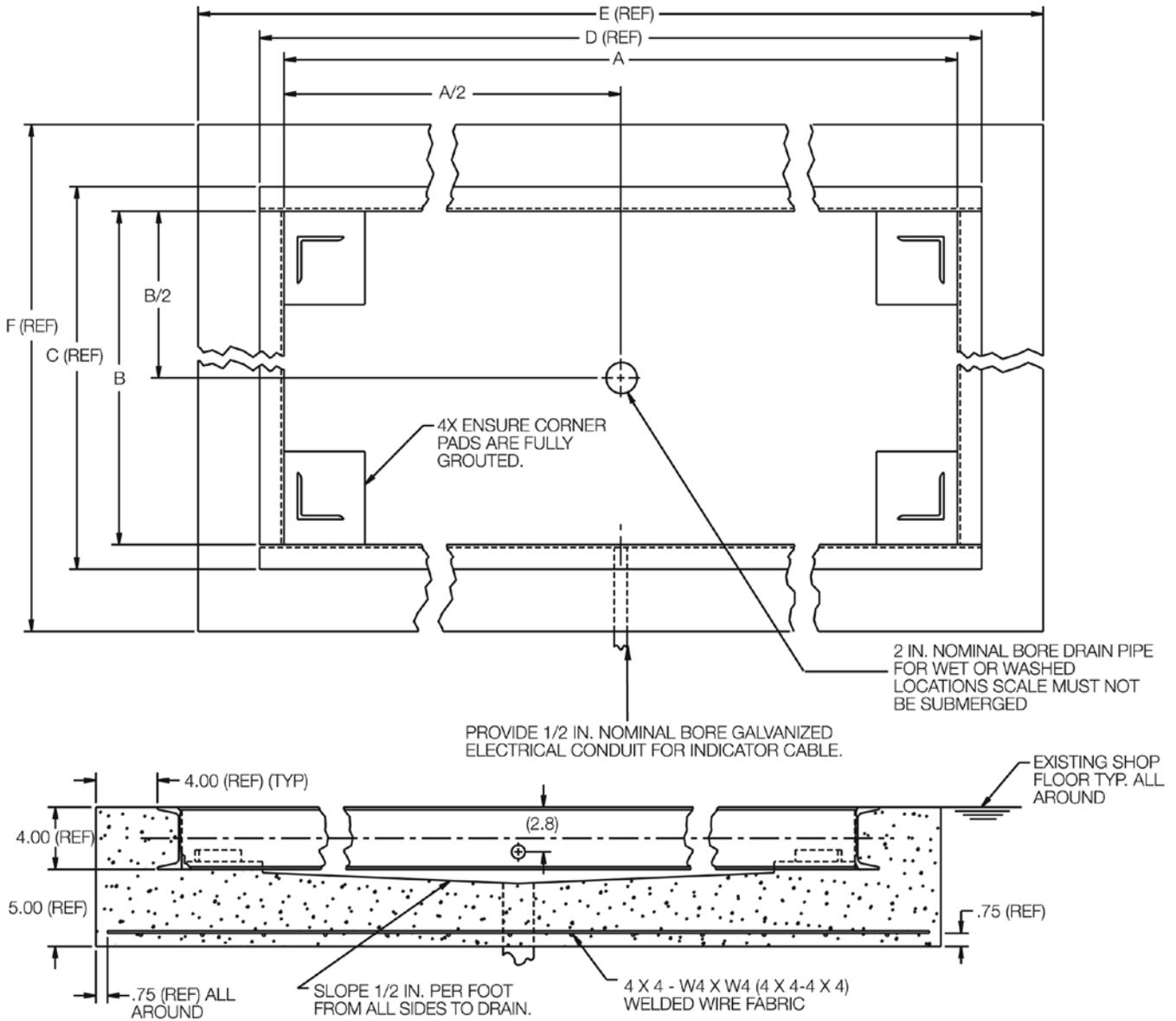

1. Use concrete of minimum yield strength 5,000 PSI or six-bag mix.
2. Allow seven days to cure (wet concrete periodically during this time).
3. Dimensions shown assume firm, stable soil conditions. When soil conditions are not adequate, place foundation at sufficient depth.
4. In wet or washdown applications we recommend the use of hermetically sealed load cells and that the junction box be mounted remotely in a dry location.
5. Wire mesh to have minimum 0.75 in cover bottom and sides.

### DRAWING DIMENSIONS

Scale Size	3 ft x 3 ft	4 ft x 4 ft	4 ft x 5 ft	4 ft x 6 ft	5 ft x 5 ft
A	36.75	48.75	60.75	72.75	60.75
B	36.75	48.75	48.75	48.75	60.75
C	39.92	51.92	51.92	51.92	63.92
D	39.92	51.92	63.92	75.92	63.92
E	47.92	59.92	71.92	83.92	71.92
F	47.92	59.92	59.92	59.92	71.92

All dimensions are shown in inches. Drawing #S77687

\* Drawings are for standard catalog part numbered scales.



# Forklift/Pallet Jack Scales

## Table of Contents

<b>CLS-420 Wired Version</b> .....	<b>300</b>
Cargo Lift Scale	
<b>CLS-420 Wireless Version</b> .....	<b>303</b>
Cargo Lift Scale	
<b>CLS-920i® Wired Version</b> .....	<b>306</b>
Cargo Lift Scale	
<b>CLS-920i® Wireless Version</b> .....	<b>309</b>
Cargo Lift Scale	
<b>Intercomp PW800™</b> .....	<b>312</b>
Pallet Truck Scale	

**ESPAÑOL** | Visit [ricelake.com/spanish](http://ricelake.com/spanish)  
to see all RLWS materials  
available in Spanish

Product names, logos, brands, and other trademarks featured or referred to within this publication are the property of their respective trademark holders.

# CLS-420 Wired Version

Cargo Lift Scale

## Standard Features

### Scale Carriage

- Compatible with Class II or III cleat type carriages
- Out of level NTEP tolerance at 7 degrees pitch and roll, 3 degrees side to side
- 1 1/2 in thick front and back painted steel plates coupled by four flexures
- Top cleats are welded, pinned and bolted
- Welded centering pin
- 6 in x 20 3/4 in viewing portal allows driver a clear view of forks
- Mechanical overload stops
- Two 5,000 pound S-Beam load cells
- iQUBE™2 j-box with inclinometer

### 420 Plus Indicator

- Six digit, 0.8 in red LED display
- Full numeric keypad for manual tare entry
- Accumulate weight function using the print key for multiple pallets
- Front panel calibration
- RS-232 port transmits time, date and weight for interface to PC
- 9-36 VDC power supply for use on propane forklifts
- Stainless steel enclosure
- Two piece top cage indicator mounting assembly with vibration mounts
- ON/OFF switch

### Factory Recommendations

- Rice Lake recommends using Zebra RW 220 or RW 420 portable thermal printer
- When installing a forklift scale on an electric forklift, static discharge protection must be installed on the forklift by a forklift service provider
- When installing a forklift scale, OSHA requires the end user to de-rate the lift capacity of the forklift
- Compatible with most Class II and Class III forklift attachments, consult factory
- Power conditioner installed when used on electric forklift scales



## APPROVALS



## Specifications

### Scale Capacity:

- 28 in & 34 in: 5,000 lb x 5 lb NTEP approved
- 5,000 lb x 1 lb non type approved
- 38 in: 8,000 lb x 5 lb non type approved

### Scale Power:

Supplied by indicator through coiled interface cable

### Scale Material/Finish:

Painted Steel

### 420 Plus Display:

0.8 in (20 mm), 6-digit Super Red Light Emitting Diode (LED), 7-segment digits

### 420 Power - DC:

Line voltages: 9-36VDC DC input  
Power consumption: 0.75A Max Fused at 5.0A

### 420 Status Annunciators:

Designators for: center of zero, stand still, gross, net, lb, kg, tare

### 420 Operating Temperature:

Legal: 14°F to 104°F (-10°C to 40°C)  
Industrial: 14°F to 122°F (-10°C to 50°C)

### Warranty:

Two-year limited warranty

### Approval:

NTEP CC 06-074 (5,000 lb only) per H-44 at 1,000 divisions

# CLS-420 Wired Version

Cargo Lift Scale

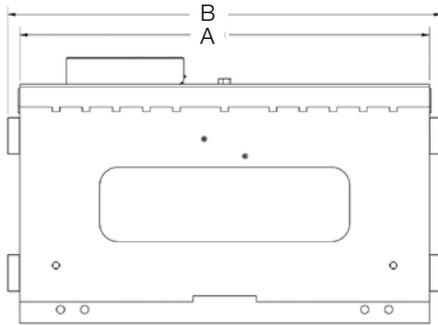

Front view

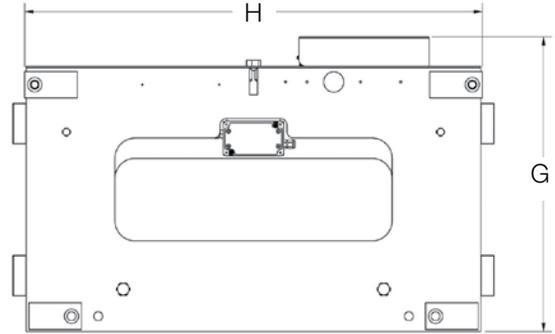

Rear view

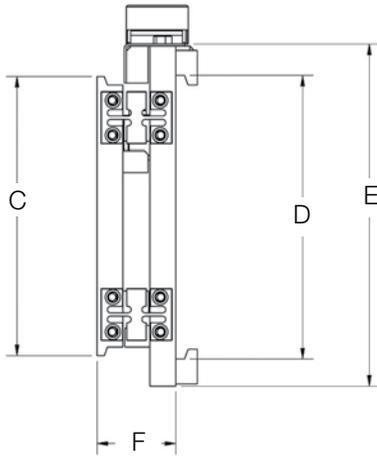

Side view

CLS DIMENSIONS			
<b>28 in, 5,000 lb</b>			
A	28 in (711.2 mm)	E	19.50 in (495.3 mm)
B	30 in (762.2 mm)	F	4.49 in (114 mm)
C	16 in (406.4 mm)	G	21.80 in (553.7 mm)
D	16.29 in (413.8 mm)	H	28.24 in (717.3 mm)
<b>34 in, 5,000 lb</b>			
A	34 in (863.6 mm)	E	19.50 in (495.3 mm)
B	36 in (914.4 mm)	F	4.49 in (114 mm)
C	16 in (406.4 mm)	G	21.80 in (553.7 mm)
D	16.29 in (413.8 mm)	H	34.24 in (869.7 mm)
<b>38 in, 8,000 lb</b>			
A	38 in (965.2 mm)	E	24.50 in (622.3 mm)
B	40 in (1016 mm)	F	6.04 in (153.4 mm)
C	20 in (508 mm)	G	26.68 in (677.7 mm)
D	20.15 in (511.8 mm)	H	38 in (965.2 mm)

Contact factory for 28in and 38in front plate dimensions if adding an attachment

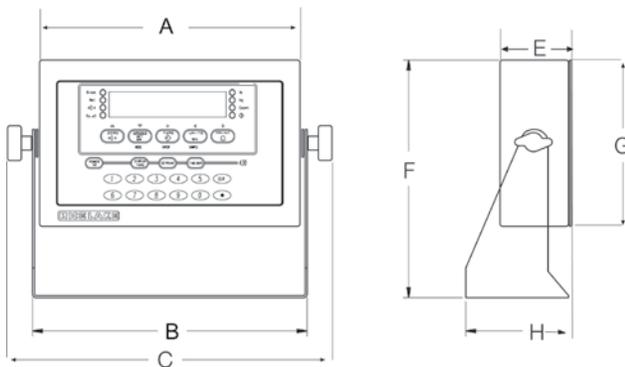

420 Plus Side view

420 PLUS DIMENSIONS			
A	9.50 in (24 mm)	F	8.57 in (217 mm)
B	10.02 in (254 mm)	G	6.00 in (152 mm)
C	11.80 in (299 mm)	H	3.25 in (82 mm)
E	3.12 in (79 mm)		3.0 in (76.2 mm)

# CLS-420 Wired Version

Cargo Lift Scale

## Part Number/Price

PART #	SIZE, CAPACITY	FORKLIFT COMPATIBILITY	WEIGHT	PRICE
<b>CLS Forklift Scale, 420 Wired Version with iQUBE2</b>				
162275	5,000 x 5 lb NTEP approved	28 in W, Class II 16 in forklift carriage (30 in W with flexures)	524 lb	\$6,550.00
162279	5,000 x 5 lb NTEP approved	34 in W, Class II 16 in forklift carriage (36 in W with flexures)	539 lb	6,550.00
162277	8,000 x 5 lb Non Legal for Trade	38 in W, Class III 20 in forklift carriage (40 in W with flexures)	1144 lb	8,150.00

*\*Non-NTEP*

*If used with an electric forklift, select the 10-60VDC option below*

## Options/Accessories

PART #	DESCRIPTION	PRICE
112986	Wireless LAN card 802.11 B/G, requires factory installation	\$638.00
	Bluetooth module, factory installed	Consult
162320	10-60VDC, CLS-420 indicator upgrade (factory installed)	395.00
<b>Replacement Parts</b>		
96196	Custom load cell box wrench	60.00
162310	CLS 420i replacement indicator, 9-36VDC	1,200.00
125395	Coiled cable (j-box to indicator)	295.00
96915	Power cable assembly with power fuse cable	90.00
130129	Power fuse cable assembly	20.95
125543	RL20000 FLS load cell 5K 1.5 mv/v 350 ohm (for use with 130826) with automotive quick disconnects	695.00
162645	CLS-420 iQUBE2 j-box assembly (for use on 162275 and 162279 only)	695.00
162291	CLS-420 iQUBE2 j-box assembly (for use on 162277)	695.00
<b>Manuals</b>		
96483	CLS-420 installation manual	20.00
96484	CLS-420 operator card	10.00

# CLS-420 Wireless Version

Cargo Lift Scale

## Standard Features

### Scale Carriage

- Compatible with Class II or III cleat type carriages
- Out of level NTEP tolerance at 7 degrees pitch and roll, 3 degrees side to side
- 1 1/2 inch thick front and back painted steel plates coupled by four flexures
- Top cleats are welded, pinned and bolted
- Welded centering pin
- 6 inch x 20 3/4 inch viewing portal allows driver a clear view of forks
- Mechanical overload stops
- Two 5,000 pound S-Beam load cells
- iQUBE™ j-box with inclinometer

### 420 Plus Indicator

- Six digit, 0.8 inch red LED display
- Full numeric keypad for manual tare entry
- Accumulate weight function using the print key for multiple pallets
- Front panel calibration
- RS-232 port transmits time, date and weight for interface to PC or 10-60 VDC power supply for use on propane forklifts
- Stainless steel enclosure
- Two piece top cage indicator mounting assembly with vibration mounts
- ON/OFF switch

### Optional Field Installed 802.15 Wireless Load Cell Kit

- Eliminates coiled cable from j-box to indicator
- Reinforced battery box welded onto cover plate to withstand harsh forklift environment
- On/Off switch to conserve battery life, with green LED
- 802.15 Wireless Load Cell Kit from scale to indicator
- Battery life, minimum 24 hours constant use with only 8 hours to fully charge
- Includes two lithium ion smart batteries and charger

### Factory Recommendations

- Rice Lake recommends using Zebra RW 220 or RW 420 portable thermal printer
- When installing a forklift scale on an electric forklift, static discharge protection must be installed on the forklift
- When installing a forklift scale, OSHA requires the end user to de-rate the lift capacity of the forklift
- Compatible with most Class II and Class III forklift attachments, consult factory
- Power conditioner installed when used on electric forklift scales



## APPROVALS



## Specifications

### Scale Capacity:

- 28 in & 34 in: 5,000 lb x 5 lb NTEP approved
- 5,000 lb x 1 lb non type approved
- 38 in: 8,000 lb x 5 lb non type approved

### Scale Power:

Supplied by indicator through coiled interface cable

### Scale Material/Finish:

Painted Steel

### 420 Plus Display:

0.8 in (20 mm), 6-digit Super Red Light Emitting Diode (LED), 7-segment digits

### 420 Power - DC:

Line voltages: 9-36VDC DC input  
Power consumption: 0.75A Max Fused at 5.0A

### 420 Status Annunciators:

Designators for: center of zero, stand still, gross, net, lb, kg, tare

### 420 Operating Temperature:

Legal: 14°F to 104°F (-10°C to 40°C)  
Industrial: 14°F to 122°F (-10°C to 50°C)

### Warranty:

Two-year limited warranty

### Approvals:

NTEP CC 06-074 (5,000 lb only) per H-44 at 1,000 divisions

# CLS-420 Wireless Version

Cargo Lift Scale

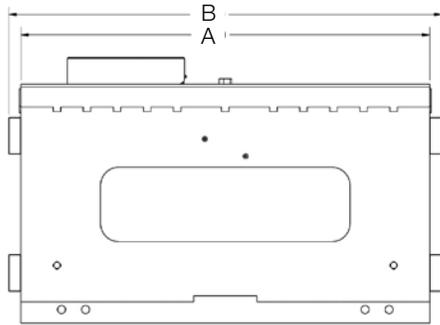

Front view

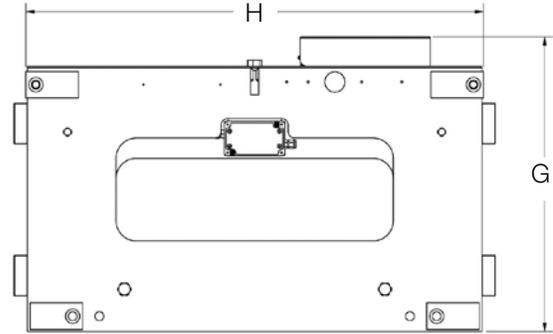

Rear view

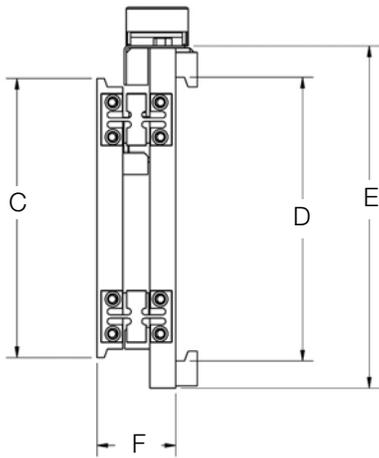

Side view

### CLS DIMENSIONS

#### 28 in, 5,000 lb

A	28	E	19.50
B	30	F	4.49
C	16	G	21.80
D	16.29	H	28.24

#### 34 in, 5,000 lb

A	34	E	19.50
B	36	F	4.49
C	16	G	21.80
D	16.29	H	34.24

#### 38 in, 8,000 lb

A	38	E	24.50
B	40	F	6.04
C	20	G	26.68
D	20.15	H	38

Contact factory for 28" and 38" front plate dimensions if adding an attachment

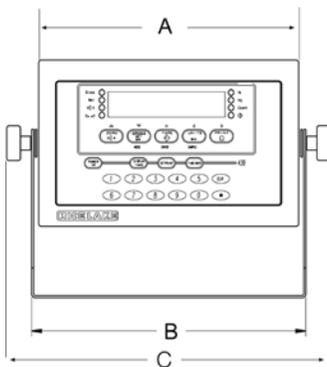

420 Plus Side view

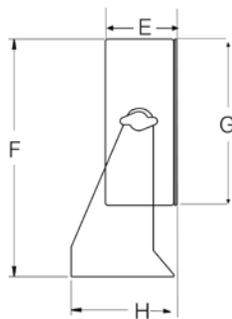

### 420 PLUS DIMENSIONS

A	9.50 in (24 mm)	F	8.57 in (217 mm)
B	10.02 in (254 mm)	G	6.00 in (152 mm)
C	11.80 in (299 mm)	H	3.25 in (82 mm)
E	3.12 in (79 mm)		3.0 in (76.2 mm)

# CLS-420 Wireless Version

Cargo Lift Scale

## Part number/Price

PART #	SIZE, CAPACITY	FORKLIFT COMPATIBILITY	WEIGHT	PRICE
<b>CLS Forklift Scale, 420 Wireless Version</b>				
111034	5,000 x 5 lb NTEP approved	28 in W, Class II 16 in forklift carriage (30 in W with flexures)	524 lb	\$7,950.00
130823	5,000 x 5 lb NTEP approved	34 in W, Class II 16 in forklift carriage (36 in W with flexures)	539 lb	7,950.00
151506*	8,000 x 5 lb Non Legal for Trade	38 in W, Class III 20 in forklift carriage (40 in W with flexures)	1144 lb	9,550.00

\*Non-NTEP

## Options/Accessories

PART #	DESCRIPTION	PRICE
112986	Wireless LAN card 802.11 B/G, requires factory installation	\$638.00
Consult	Bluetooth module, factory installed	Consult
<b>Replacement Parts</b>		
96196	Custom load cell box wrench	60.00
98413	CLS 420i replacement indicator	1,200.00
96915	Power cable assembly with power fuse cable	90.00
130129	Power fuse cable assembly	20.95
96198	RL 20000 FLS load cell 5K 1.5 mv/v 350 ohm (for use with 121014)	695.00
121014	iQUBE™ J-box assembly, (for use with 111034), Class II	575.00
121366	iQUBE J-box assembly, (for use with 130823), Class III	575.00
125543	RL20000 FLS load cell 5K 1.5 mv/v 350 ohm (for use with 130826) with automotive quick disconnects	695.00
130826	iQUBE j-box assembly (for use with 130823), Class II with automotive quick disconnects	575.00
96343	Battery, forklift lithium ion	295.00
96344	Battery charger, forklift	546.00
<b>Manuals</b>		
96483	CLS-420 installation manual	20.00
96484	CLS-420 operator card	10.00

# CLS-920i® Wired Version

Cargo Lift Scale

## Standard Features

### Scale Carriage

- Compatible with Class II or III cleat type carriages
- Out of level NTEP tolerance at 7 degrees pitch and roll, 3 degrees side to side
- 1 1/2 in thick front and back painted steel plates coupled by four flexures
- Top cleats are welded, pinned and bolted
- Welded centering pin
- 6 in x 20 3/4 in viewing portal allows driver a clear view of forks
- Mechanical overload stops
- Two 5,000 pound S-Beam load cells
- iQUBE™2 j-box with inclinometer

### 920 and Indicator

- 4.6 in W x 3.4 in H, back-lit LCD graphical display (320 x 420 pixels)
- Standard user program with data collection and transaction storage including: ID number, ID open/closed, operator ID, time and date, weight and accumulation
- Front panel calibration, with advanced diagnostics to indicate excessive drift, A/D failures, connection errors, excitation voltage shifts and more
- Internal memory of 1 MB for transaction records
- 9-36 VDC power supply for use on propane or electric forklifts
- On/Off switch to conserve forklift battery life
- Painted mild steel enclosure
- Two piece top cage indicator mounting assembly with vibration mounts

### Factory Recommendations

- Rice Lake recommends using Zebra RW 220 or RW 420 portable thermal printer
- When installing a forklift scale on an electric forklift, static discharge protection must be installed on the forklift by a forklift service provider
- When installing a forklift scale, OSHA requires the end user to de-rate the lift capacity of the forklift
- Compatible with most Class II and Class III forklift attachments, consult factory
- Power conditioner installed when used on electric forklift scales



## APPROVALS



## Specifications

### Scale Capacity:

- 28 in & 34 in: 5,000 lb x 5 lb NTEP approved
- 5,000 lb x 1 lb non type approved
- 38 in: 8,000 lb x 5 lb non type approved

### Scale Power:

Supplied by indicator through coiled interface cable

### Scale Material/Finish:

Painted Mild Steel

### 920i Power - DC:

Line voltages: 9-36VDC DC input  
Power consumption: 1.5A Max Fused at 5.0A

### 920i Operating Temperature:

Legal: 14°F to 104°F (-10°C to +40°C)  
Industrial: 14°F to 122°F (-10°C to +50°C)

### Wireless LAN Option:

Contains FCC ID: R68WIPORATG  
Range: Up to 328 ft indoors  
Operating Frequency: ISM 2.4 GHz

### Warranty:

Two-year limited warranty

### Approvals:

NTEP CC 06-074 (5,000 lb only) per H-44 at 1,000 divisions



# CLS-920i® Wired Version

Cargo Lift Scale

Front view

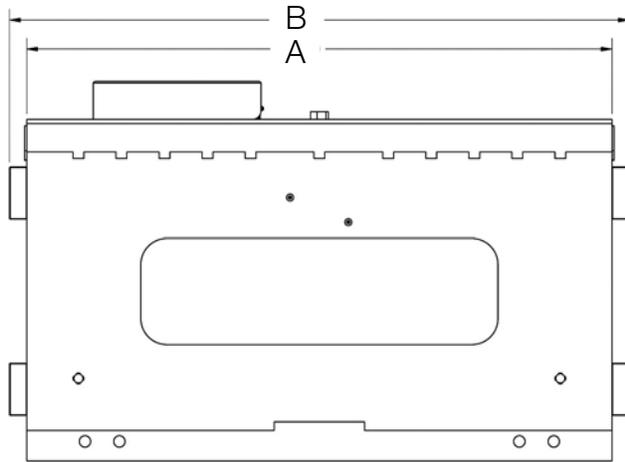

CLS DIMENSIONS			
<b>28 in, 5000 lb</b>			
A	28	E	19.50
B	30	F	4.49
C	16	G	21.80
D	16.29	H	28.24
<b>34 in, 5000 lb</b>			
A	34	E	19.50
B	36	F	4.49
C	16	G	21.80
D	16.29	H	34.24
<b>38 in, 8000 lb</b>			
A	38	E	24.50
B	40	F	6.04
C	20	G	26.68
D	20.15	H	38

Contact factory for 28" and 38" front plate dimensions if adding an attachment

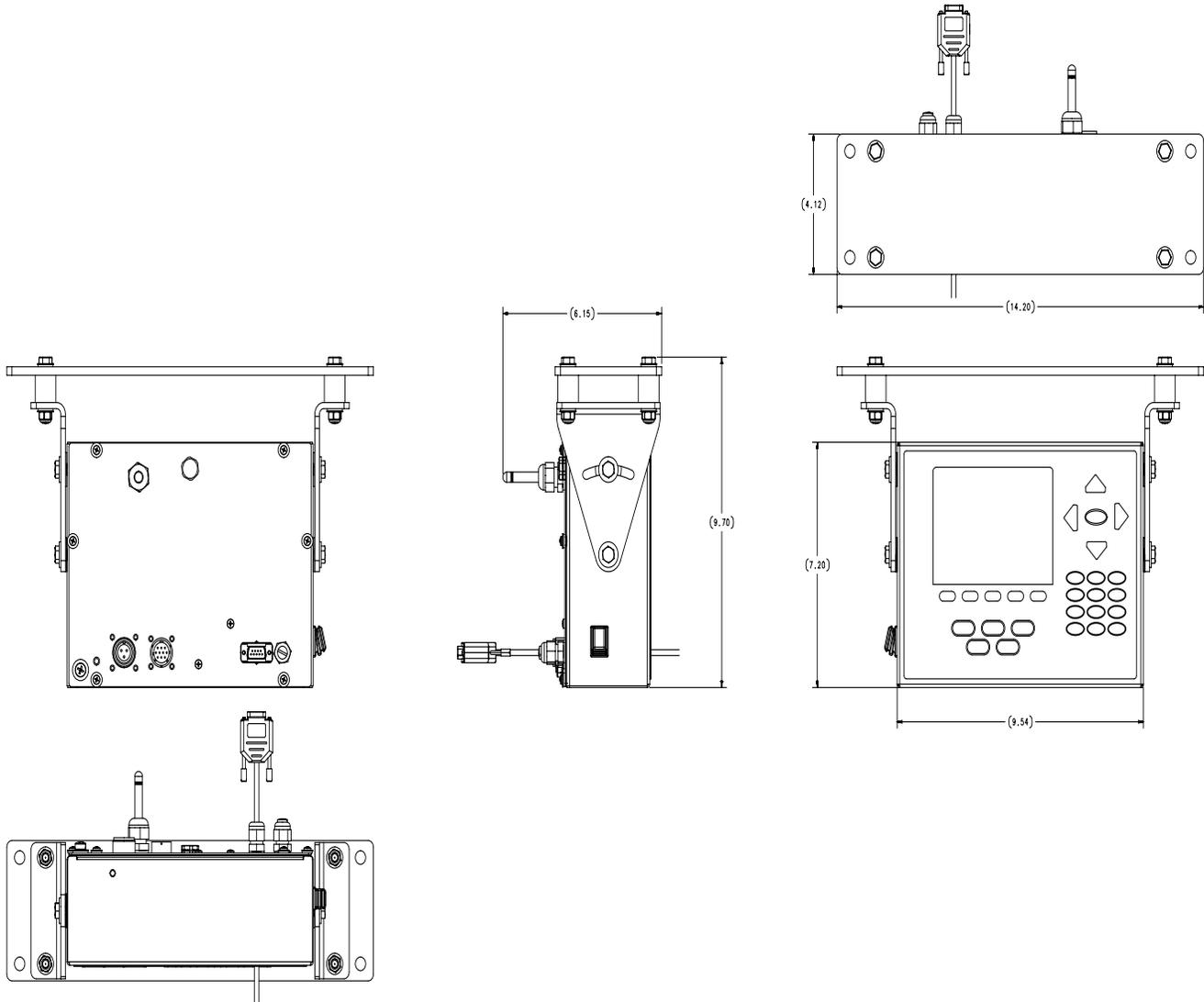

# CLS-920i® Wired Version

Cargo Lift Scale

## Part Number/Price

PART #	SIZE, CAPACITY	FORKLIFT COMPATIBILITY	WEIGHT	PRICE
<b>CLS Forklift Scale, 920i Wired Version</b>				
162281	5,000 x 5 lb NTEP approved	28 in W, Class II 16 in forklift carriage (30 in W with flexures) 9-36VDC	524 lb	\$7,200.00
162282	5,000 x 5 lb NTEP approved	34 in W, Class II 16 in forklift carriage (36 in W with flexures) 9-36VDC	539 lb	7,200.00
162283	8,000 x 5 lb Non Legal for Trade	38 in W, Class III 20 in forklift carriage (40 in W with flexures) 9-36VDC	1144 lb	8,800.00

*\*Non-NTEP*

*If used with electric forklift, select the 10-60VDC option below*

## Options/Accessories

PART #	DESCRIPTION	PRICE
96355	Wireless LAN card 802.11 B/G, requires factory installation	\$587.00
Consult	Bluetooth module, factory installed	Consult
162354	10-60VDC, CLS-920i indicator upgrade	395.00
<b>Replacement Parts</b>		
96196	Custom load cell box wrench	60.00
162112	CLS 920i replacement indicator, 9-36VDC	2,200.00
125395	Coiled cable (j-box to indicator)	295.00
96915	Power cable assembly with power fuse cable	90.00
130129	Power fuse cable assembly	20.95
159589	CLS-920i iQUBE2 j-box assembly (for use on 162281 and 162282)	695.00
165311	CLS-920i iQUBE2 j-box assembly (for use on 162283)	695.00
125543	RL20000 FLS load cell 5K 1.5 mv/v 350 ohm (for use with 130826) with automotive quick disconnects	695.00

# CLS-920i® Wireless Version

Cargo Lift Scale

## Standard Features

### Scale Carriage

- Compatible with Class II or III cleat type carriages
- Out of level NTEP tolerance at 7 degrees pitch and roll, 3 degrees side to side
- 1 1/2 inch thick front and back painted steel plates coupled by four flexures
- Top cleats are welded, pinned and bolted
- Welded centering pin
- 6 inch x 203/4 inch viewing portal allows driver a clear view of forks
- Mechanical overload stops
- Two 5,000 pound S-Beam load cells
- iQUBE™1 j-box with inclinometer

### 920 Plus Indicator

- 4.6in W x 3.4in H, back-lit LCD graphical display (320 x 420 pixels)
- Standard user program with data collection and transaction storage including: pro number, pro open/closed, employee ID, last transaction, time and date, actual weight and number of skids
- Front panel calibration, with advanced diagnostics to indicate excessive drift, A/D failures, connection errors, excitation voltage shifts and more
- Internal memory of 1 MB for transaction records
- 10-60 VDC power supply for use on propane or electric forklifts
- On/Off switch to conserve forklift battery life
- Stainless steel enclosure
- Two piece top cage indicator mounting assembly with vibration mounts

### Optional Field Installed 802.15 Wireless Load Cell Kit

- Eliminates coiled cable from j-box to indicator
- Reinforced battery box welded onto cover plate to withstand harsh forklift environment
- On/Off switch to conserve battery life, with green LED
- 802.15 Wireless Load Cell Kit from scale to indicator
- Battery life, minimum 24 hours constant use with only 8 hours to fully charge
- Includes two lithium ion smart batteries and charger

### Factory Recommendations

- Rice Lake recommends using Zebra RW 220 or RW 420 portable thermal printer
- When installing a forklift scale on an electric forklift, static discharge protection must be installed on the forklift by a forklift service provider
- When installing a forklift scale, OSHA requires the end user to de-rate the lift capacity of the forklift
- Compatible with most Class II and Class III forklift attachments, consult factory
- Power conditioner installed when used on electric forklift scales



## APPROVALS



## Specifications

### Scale Capacity:

- 28 in & 34 in: 5,000 lb x 5 lb NTEP approved
- 5,000 lb x 1 lb non type approved
- 38 in: 8,000 lb x 5 lb non type approved

### Scale Power:

Supplied by indicator through coiled interface cable

### Scale Material/Finish:

Stainless steel

### 920i Dimensions

10.5 x 11.2 x 4.5 in (266 x 217 x 114 mm)

### 920i Power - DC:

Line voltages: 10-60VDC DC input Power consumption: 1.5A Max Fused at 5.0A

### 920i Operating Temperature:

Legal: 14°F to 104°F (-10°C to +40°C)  
Industrial: 14°F to 122°F (-10°C to +50°C)

### Wireless LAN Option:

Contains FCC ID: R68WIPORATG  
Range: Up to 328 ft indoors  
Operating Frequency: ISM 2.4 GHz

### Warranty:

Two-year limited warranty

### Approvals:

NTEP CC 06-074 (5,000 lb only) per H-44 at 1,000 divisions

# CLS-920i® WirelessVersion

Cargo Lift Scale

Front view

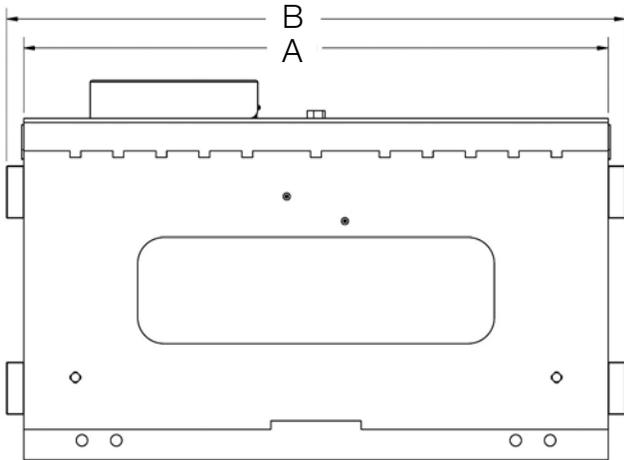

### CLS DIMENSIONS

#### 28 in, 5000 lb

A	28	E	19.50
B	30	F	4.49
C	16	G	21.80
D	16.29	H	28.24

#### 34 in, 5000 lb

A	34	E	19.50
B	36	F	4.49
C	16	G	21.80
D	16.29	H	34.24

#### 38 in, 8000 lb

A	38	E	24.50
B	40	F	6.04
C	20	G	26.68
D	20.15	H	38

Side view

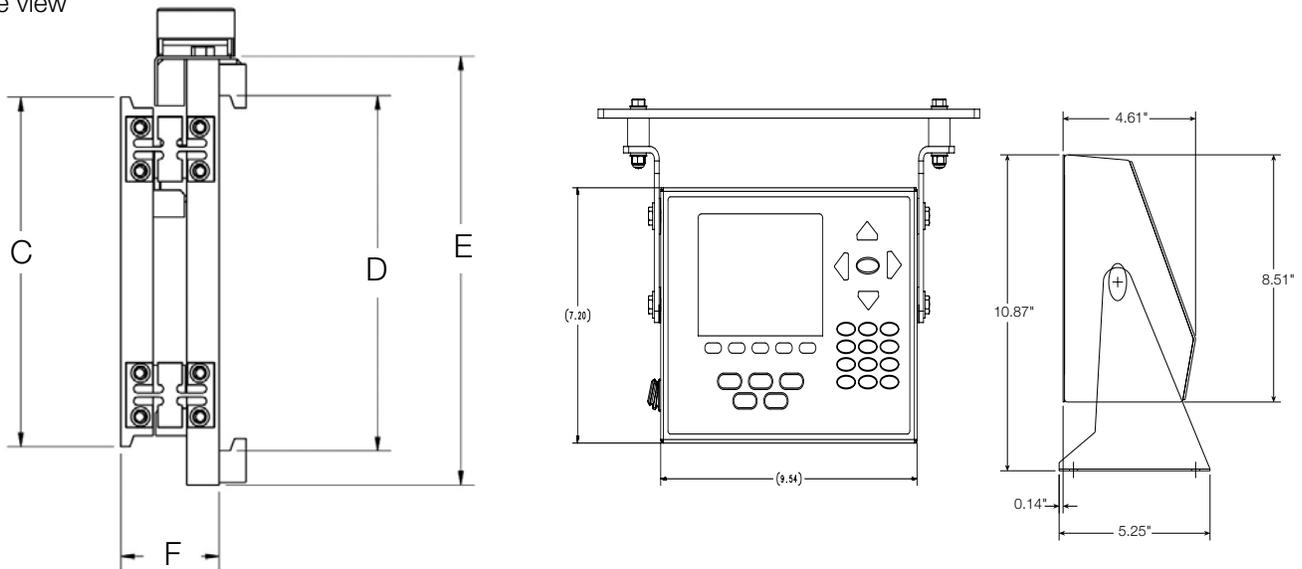

920i Universal

Rear view

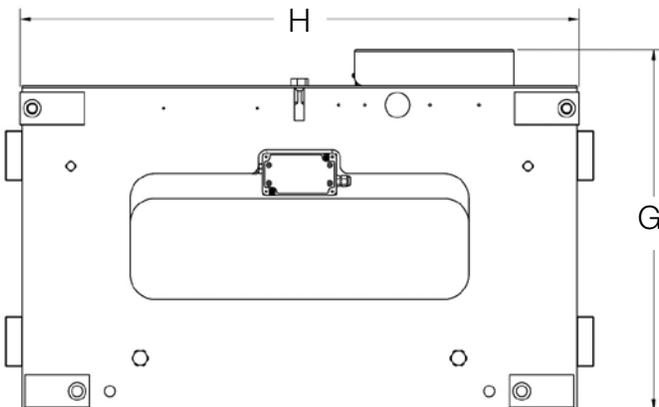

# CLS-920i® Wireless Version

Cargo Lift Scale

## Part Number/Price

PART #	SIZE, CAPACITY	FORKLIFT COMPATIBILITY	WEIGHT	PRICE
<b>CLS Forklift Scale, 920i Wireless Version</b>				
111036	5,000 x 5 lb NTEP approved	28 in W, Class II 16 in forklift carriage (30 in W with flexures) 10-60VDC	524 lb	\$8,600.00
130825	5,000 x 5 lb NTEP approved	34 in W, Class II 16 in forklift carriage (36 in W with flexures) 10-60VDC	539 lb	8,600.00
151490*	8,000 x 5 lb Non Legal for Trade	38 in W, Class III 20 in forklift carriage (40 in W with flexures) 10-60VDC	1144lb	10,200.00

\*Non-NTEP

## Options/Accessories

PART #	DESCRIPTION	PRICE
96355	Wireless LAN card 802.11 B/G, requires factory installation	\$587.00
Consult	Bluetooth module, factory installed	Consult
<b>Replacement Parts</b>		
96196	Custom load cell box wrench	60.00
97468	CLS 920i replacement indicator	2,200.00
96252	Coiled cable (j-box to indicator), black	295.00
96915	Power cable assembly with power fuse cable	90.00
130129	Power fuse cable assembly	20.95
96198	RL 20000 FLS load cell 5K 1.5 mv/v 350 ohm (for use with 121014)	695.00
121014	iQUBE™ J-box assembly, (for use with 96198), Class II	695.00
121366	iQUBE J-box assembly, (for use with 96198), Class III	695.00
125543	RL20000 FLS load cell 5K 1.5 mv/v 350 ohm (for use with 130826) with automotive quick disconnects	695.00
130826	iQUBE j-box assembly (for use with 125543), Class II with automotive quick disconnects	695.00
132960	iQUBE j-box assembly (for use with 125543), Class III with automotive quick disconnects	695.00
96343	Battery, forklift lithium ion	295.00
96344	Battery charger, forklift	546.00

# Intercomp PW800™

Pallet Truck Scale

## Standard Features

- Includes internal charger and 9 "D" size NiCad batteries
- Fast, low-cost parts counting for taking inventory
- Count totalization up to 1 million counts
- Accuracy of  $\pm 0.1\%$
- Tare: up to 100% of capacity
- Zero: up to 100% of capacity
- Units of measure: lb/kg
- 5,000 lb capacity in one-pound increments
- Push-button print for gross, net, tare, total and count total
- Displays gross, net and tare weight
- Weight totalization up to 100,000 lb
- Adjustable baud rates from 75 to 9600
- Quick verification of incoming/outgoing freight
- Instant check of truck loading by weight
- Large, easy-to-read 0.8 in six-digit LED display
- Adjustable display update/weight averaging
- Selectable AZT off, 0.6, 1, or 3 graduations
- Mild steel

## Specifications

**Capacity:**

5,000 lb (2,500 kg)

**Graduation:**

1 lb (.5 kg)

**Accuracy:**

$\pm 0.1\%$  of reading

**Battery Life:**

Up to 25 hours of continuous use on NiCad batteries (included) Up to 75 hours of continuous use on Alkaline batteries (not included)

**Batteries:**

Nine D size rechargeable nickel-cadmium cells

**Charge Time:**

16 hours

**Charge:**

Charger/power transformer—120/220VAC

**Low Battery Shut-Off:**

Unit automatically shuts off if batteries are low

**Auto Shut-Off:**

Shuts off after up to five minutes of non-use (variable up to 30 min)

**Display:**

0.8 in (20 mm) high—5 1/2-digit LED (Light Emitting Diode)

**Indicators:**

Six (lb, kg, net, tare, total, count)

**Control Switches:**

Eight (on, off, set mode, print, tare, zero, lb/kg)

**Humidity:**

10 to 95% non-condensing

**Temperature:**

Operating: -20°C to 60°C (-4°F to 140°F)

**Fork Dimensions:**

PW800-2748: 48 x 27 x 2.9 in (1219 x 686 x 74 mm)

**Est. Ship Weight:**

300 lb (136 kg)

**Warranty:**

One-year limited warranty



## Part Number/Price

PART #	MODEL	FORK SIZE	CAPACITY	EST. SHIP WEIGHT	PRICE
43659*	PW800-2748	48 in x 27 in x 2.9 in	5,000 lb	300 lb	\$3,350.00

## Options/Accessories

PART #	DESCRIPTION	PRICE
43946	RS-232 serial output	\$195.00

\*Includes pallet truck, 120V/220V charger, nine D size Nicads

# Hanging Scales

Table of Contents

Rice Lake On-Site OS-10/OS-25/ OS-45.....	314
Salter Model 235-6S.....	315
Salter Electro Samson.....	316

**ESPAÑOL** | Visit [ricelake.com/spanish](http://ricelake.com/spanish)  
to see all RLWS materials  
available in Spanish

The following product names, logos, brands, and other trademarks featured or referred to within this publication are the property of their respective trademark holders.

# Rice Lake On-Site OS-10/OS-25/OS-45

## Standard Features

- Hold function
- Units of measure kg/lb/lb-oz
- Adjustable automatic shutoff
- Ergonomic handheld design
- Battery operated, (2) AA batteries included
- Carrying case and top s-hook included
- Limited one-year warranty

## Part Number/Price

PART #	MODEL	CAPACITY	EST. SHIP WEIGHT	PRICE
130292	OS-10	10 x 0.01 kg/22 x 0.02 lb/22 lb x 1/4 oz	1.25 lb	\$75.00
130293	OS-25	25 x 0.02 kg/55 x 0.05 lb/55 lb x 1/2 oz	1.25 lb	75.00
130294	OS-45	45 x 0.05 kg/99 x 0.1 lb/99 lb x 1 oz	1.25 lb	75.00





# Salter Model 235-6S

## Standard Features

- Versatile
- Lightweight
- Maintenance free
- Corrosion resistant
- High-strength stainless steel fittings
- Thumbwheel zero adjustment (approx. ± 10%)
- Top and bottom hook supplied
- One-year limited warranty

## Part Number/Price

PART #	MODEL	CAPACITY	EST. SHIP WEIGHT	PRICE
43712	Model 235-6S-11	11 lb x 1 oz/5 kg x 20 g	4 lb	\$100.00
43713	Model 235-6S-22	22 lb x 2 oz/10 kg x 50 g	4 lb	100.00
43714	Model 235-6S-55	55 lb x 4 oz/25 kg x 100 g	4 lb	100.00
43715	Model 235-6S-110	110 lb x 8 oz/50 kg x 200 g	4 lb	100.00
43716	Model 235-6S-220	220 lb x 1 lb/100 kg x 500 g	4 lb	100.00



DIMENSIONS WITH HOOKS			
Capacity	L	W	D
11 lb x 1 oz/5 kg x 20 g	14.33 in (364 mm)	6.77 in (172 mm)	2.25 in (57 mm)
22 lb x 2 oz/10 kg x 50 g	14.33 in (364 mm)	6.77 in (172 mm)	2.25 in (57 mm)
55 lb x 4 oz/25 kg x 100 g	14.33 in (364 mm)	6.77 in (172 mm)	2.25 in (57 mm)
110 lb x 8 oz/50 kg x 200 g	16.29 in (414 mm)	6.77 in (172 mm)	2.25 in (57 mm)
220 lb x 1 lb/100 kg x 500 g	16.29 in (414 mm)	6.77 in (172 mm)	2.25 in (57 mm)

DIMENSIONS WITHOUT HOOKS			
Capacity	L	W	D
11 lb x 1 oz/5 kg x 20 g	14.5 in (368 mm)	6.77 in (172 mm)	2.25 in (57 mm)
22 lb x 2 oz/10 kg x 50 g	14.5 in (368 mm)	6.77 in (172 mm)	2.25 in (57 mm)
55 lb x 4 oz/25 kg x 100 g	14.5 in (368 mm)	6.77 in (172 mm)	2.25 in (57 mm)
110 lb x 8 oz/50 kg x 200 g	14.5 in (368 mm)	6.77 in (172 mm)	2.25 in (57 mm)
220 lb x 1 lb/100 kg x 500 g	14.5 in (368 mm)	6.77 in (172 mm)	2.25 in (57 mm)

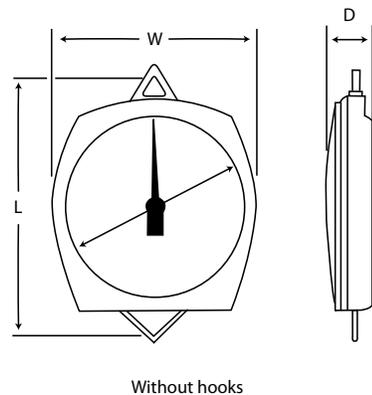
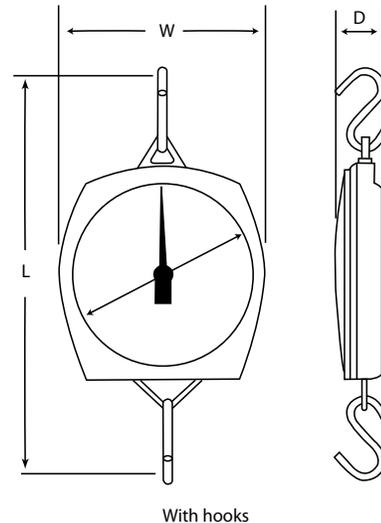

# Salter Electro Samson

## Standard Features

- Re-zero during weighing to create a tare weight, this allows weighing of container contents
- Automatic shut-off after two minutes inactivity
- "HOLD" key feature
- Units of measure: lb-oz, kg, decimal lb
- Lifting handle
- Calibration through front panel
- Battery-operated; 9V alkaline battery required
- Four digit Liquid Crystal Display (LCD), accurate to 0.5% of full range
- Dimensions: 13.4 x 3.7 x 2.2 in (340 x 95 x 55 mm)
- One-year limited warranty

## Part Number/Price

PART #	MODEL	CAPACITY	EST. SHIP WEIGHT	PRICE
43730	Electro Samson	22 lb x 0.02 lb/10 kg x 0.01 kg/22 lb x .25 oz	3 lb	\$102.00
43731	Electro Samson	55 lb x 0.05 lb/25 kg x 0.02 kg/55 lb x .50 oz	3 lb	102.00
75593	Electro Samson	100 lb x 0.1 lb/45 kg x 0.5 kg/100 lb x 2 oz	3 lb	135.00

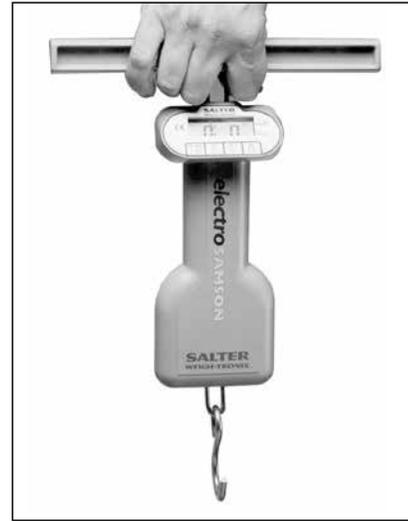

# Hardware

## Table of Contents

Load Cell Mounting Hardware Safety Guidelines.....	318	Complete Custom Cable Services .....	338
Mounting Assembly Component Identification.....	319	EL147RP Plus.....	339
Jam Nuts.....	319	Rodent Protection Cables	
Eye Nuts.....	320	Hostile Environment Load Cell Cable.....	340
Coupling Nuts.....	320	Standard Load Cell Cable.....	340
Clevis Mount Assemblies.....	321	EL147IS Hazardous Environment Blue Jacket Cable.....	341
Load Cell Eye Bolts.....	322	EL144 Communications Cable.....	341
Rod End Ball Joints.....	323	BCD Cable.....	341
Connecting Links.....	324	Fiber Optic Cable.....	342
Load Cell Isolators.....	324	SURVIVOR® EL620HE High Temperature Cable.....	342
Threaded Adapters.....	325	SURVIVOR® Cable Armor.....	342
ITCM - Isolated Tension Cell Mount Hardware Kits.....	326	EL148 HE Replacement Mettler Toledo® Power Cell® Cable.....	343
Grounding Strap.....	327	Load Cell Conduit Adapters.....	343
Load Receiver Plate.....	327	Cord Grip Assemblies.....	343
Ball Bearings.....	328	EL214 Cable Splicing Kit.....	344
Load Cups.....	328	EL214T Cable Splicing Kit.....	344
Cardinal® Wire Rope Replacement Assemblies.....	329	EL215 Cable Splicing Kit.....	344
Custom Wire Ropes.....	329	Flintec™ Load Cell Cable Replacement Kits.....	345
Wire Rope Assemblies.....	329	T-Grip Molding.....	347
Custom Wire Rope Definition.....	330	T-Strip Molding.....	347
Spherical Washer Sets.....	331	Electronic Scale Tickets.....	348
Weldless End Links.....	331	Mechanical Scale Tickets.....	349
Load Cell Spacers.....	332	Create Your Own Custom Ticket.....	349
Load Button.....	332	Scale Veils.....	350
Load Button Insert Kit.....	332	Cables.....	351
Surefoot™.....	333	Static Brushes.....	352
Flintec™ Adjustable Rubber Foot.....	333	Ionizing Strips.....	352
Bench Scale Feet.....	334	Ionizing Strips Accessories.....	352
Polyurethane Rubber Leveling.....	334	Desiccants.....	353
Captured Ball Floor Scale Leveling Feet.....	335	Industrial Corrosion Inhibitor.....	353
Leveling Pads.....	336	Crimper and Lead Seals.....	353
Leveling Mount.....	336	Static Control Table Mat and Floor Mat.....	354
Leveling Pad Stems.....	336	Static Control Wrist Strap.....	354
RoughDeck® Scale Base.....	337	Static Shielding Bags.....	354
Summit® 3000 Scale Base.....	337	Static-Safe Service Kit.....	355
Floor Scale.....	337	Portable Megometer.....	355

**ESPAÑOL** | Visit [ricelake.com/spanish](http://ricelake.com/spanish) to see all RLWS materials available in Spanish

The following product names, logos, brands, and other trademarks featured or referred to within this publication are the property of their respective trademark holders.

# Load Cell Mounting Hardware Safety Guidelines

Install only load cell mounting hardware and assemblies that have been specifically designed for use in tank, hopper or hanging scale applications. Often, the use of an inferior-grade product results in component failure which risks equipment damage and personal injury. These simple suggestions are provided to help minimize your exposure to vessel scale installation hazards.

## 1. Estimating Gross Load

To select the correct load cell or load cell hardware for a given application, it is necessary to know the total weight on the scale—including the net weight of product, the tare weight of the vessel and the weight of the platform, tank or hopper, as appropriate.

## 2. Safe Load

Do not exceed the safe load figures listed in Rice Lake Weighing Systems' catalog for any load cell hardware. Where shock loads are present, it may be necessary to derate these safe load figures depending on the severity of the shock load.

## 3. Load Distribution

In multiple load cell applications, the weight must be evenly distributed between all cells.

## 4. Threaded Connections

Check that all threads of a threaded connection are in engagement. For example, an eye bolt screwed into an S-type load cell should protrude slightly on the opposite side.

## 5. Jam Nuts

All threaded connections must be locked with jam nuts against inadvertent disassembly. If a load is suspended from a single load cell, it is critical that the load cannot rotate as this may loosen the jam nut.

## 6. Wire Rope Assemblies

With wire rope assemblies, do not twist the rope during assembly or disassembly. For example, do not remove a frozen nut from one end of a rope assembly by holding the opposite end.

## 7. Attachment Points of a Load Cell Hardware Assembly

The attachment points of a load cell hardware assembly must be aligned properly and the assembly should be essentially vertical.

## 8. Swaying in a Suspended Vessel Scale

If there is excessive swaying in a suspended vessel scale, apply horizontal checking to reduce the amplitude.

## 9. Safety Backup

If failure of one or more load cell hardware assemblies could cause injury or damage, a safety backup (safety chains, safety rods, etc.) must be used. The assemblies should be inspected routinely for damage, excessive wear or corrosion and replaced if necessary.

## 10. Hopper Scales: Guarding Against Contamination

With hopper scales, guard against contamination of the product being weighed in case of failure of the load cell or hardware assembly. For example, do not locate a wire rope assembly over a hopper scale where broken strands of wire could fall into the weighing vessel, contaminating the product being weighed.

## 11. Selecting Steel Rod or Any Other Weight-Bearing Components

Select steel rod or any other weight-bearing components so that their minimum tensile strength is at least four times the total weight carried by that component. Note that threaded rod is generally made from a low tensile-strength mild steel which should be checked for tensile strength before use in any suspended vessel scale.

# Mounting Assembly Component Identification

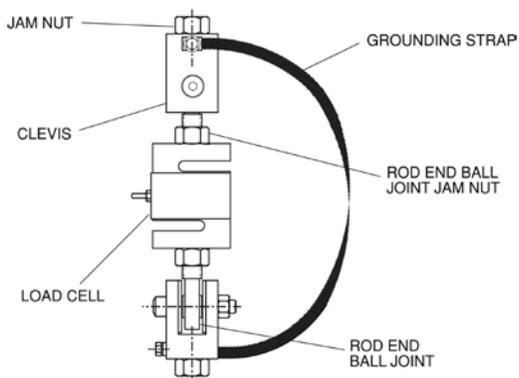

ITCM Isolated Tension Cell Mounting Assembly

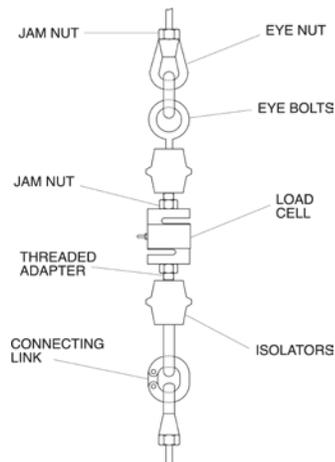

Conventional Tension Mounting Assembly

Our popular Isolated Tension Cell Mounting ITCM Assembly and other conventional suspended weighing system assemblies employ a variety of serviceable hardware components. Rice Lake Weighing Systems offers a comprehensive selection of these items for all of your suspended vessel service needs. These drawings are designed to enable you to quickly identify and differentiate components from both of these common designs. All corresponding replacement hardware is located on the following pages.

## Jam Nuts

### Standard Features

- Mild Steel/Stainless Steel
- Coarse or fine thread
- Zinc-plated mild steel or stainless steel



Important: Read "Load Cell Mounting Hardware Safety Guidelines" at the beginning of this section.

THREAD SIZE	PART #	PRICE
<b>Mild Steel, Fine Thread:</b>		
1/4-28 NF	14639	\$0.30
3/8-24 NF	14651	0.30
1/2-20 NF	14664	1.30
3/4-16 NF	14687	1.30
1-12 NF	14702	5.35
1-14 NF	14703	4.35
1 1/4-12 NF	14708	3.15
1 1/2-12 NF	14711	4.40
<b>Mild Steel, Coarse Thread:</b>		
1/4-20 NC	14636	0.30
3/8-16 NC	14649	1.80
1/2-13 NC	14661	0.30
5/8-11 NC	14676	1.80
3/4-10 NC	14686	0.80
1-8 NC	14701	0.95
1-1/4-7 NC	14707	2.85

THREAD SIZE	PART #	PRICE
<b>Stainless Steel, Fine Thread:</b>		
1/4-28 NF	14640	\$1.05
1/2-20 NF	14665	1.55
3/4-16 NF	14688	2.05
<b>Stainless Steel, Coarse Thread:</b>		
3/8-16 NC	14653	1.80
1/2-13 NC	14662	1.55
5/8-11 NC	14680	1.80
3/4-10 NC	14690	1.85

# Eye Nuts

## Standard Features

- Drop-forged steel, tapped NC right-hand threads

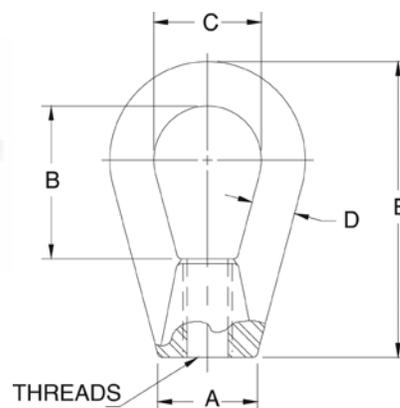

## Part Number/Price

PART #	A	B	C	D	E	THREAD SIZE	SAFE LOAD*	PRICE						
17772	0.50 in	12.7 mm	1.06 in	26.9 mm	0.75 in	19.1 mm	0.25 in	6.4 mm	1.68 in	42.7 mm	1/4-20 NC	500 lb	226.8 kg	\$37.00
17773	0.75 in	19.1 mm	1.18 in	30.0 mm	0.87 in	22.1 mm	0.31 in	7.9 mm	2.25 in	57.2 mm	3/8-16 NC	1800 lb	816.5 kg	22.00
17774	1.00 in	25.4 mm	1.56 in	39.6 mm	1.12 in	28.5 mm	0.43 in	10.9 mm	3.00 in	76.2 mm	1/2-13 NC	3600 lb	1632.9 kg	37.00
17775	1.25 in	31.8 mm	1.93 in	49.0 mm	1.37 in	34.8 mm	0.56 in	14.2 mm	3.75 in	95.3 mm	5/8-11 NC	5800 lb	2630.8 kg	42.00

\*Do not exceed the safe load

# Coupling Nuts

## Standard Features

- Heavy hex



## Part Number/Price

PART #	THREAD SIZE	LENGTH	FLAT	SAFE LOAD*	PRICE			
14638	1/4-20 NC	1.75 in	44.5 mm	0.44 in	11.2 mm	500 lb	226.8 kg	\$5.10
14650	3/8-16 NC	1.75 in	44.5 mm	0.62 in	15.8 mm	1500 lb	680.4 kg	5.65
14663	1/2-13 NC	1.75 in	44.5 mm	0.87 in	22.1 mm	3000 lb	1360.8 kg	5.65
14681	5/8-11 NC	2.12 in	53.8 mm	1.06 in	26.9 mm	7500 lb	3402.0 kg	8.25
14691	3/4-10 NC	2.25 in	57.1 mm	1.25 in	31.8 mm	10,000 lb	4535.9 kg	9.35

\*Do not exceed the safe load

Important: Read "Load Cell Mounting Hardware Safety Guidelines" at the beginning of this section.

# Clevis Mount Assemblies

## Standard Features

- Mild Steel
- Assembly used in the ITCM
- Adapts rod to rod-end ball joint
- Provides electrical isolation for load cell protection
- Elimination of unwanted side loads
- Optional stainless steel provides enhanced corrosion resistance

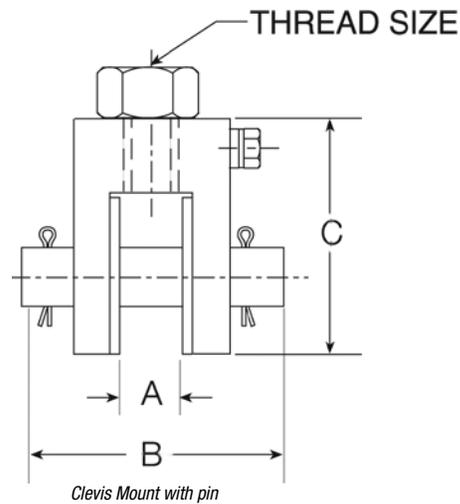
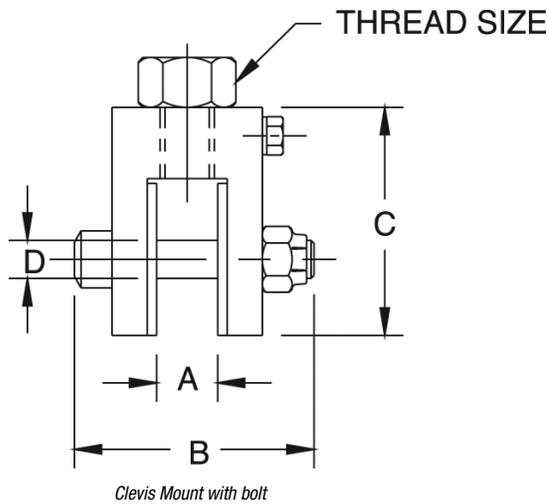

## Part Number/Price

PART #	A	B	C	D	THREAD SIZE	SAFE LOAD*	PRICE					
<b>Mild Steel with bolt:</b>												
17792	0.52 in	13.2 mm	2.38 in	60.5 mm	1.94 in	49.3 mm	0.38 in	9.5 mm	3/8-16 NC	300 lb	136.1 kg	\$75.00
17793	0.52 in	13.2 mm	2.38 in	60.5 mm	1.94 in	49.3 mm	0.38 in	9.5 mm	1/2-13 NC	300 lb	136.1 kg	75.00
17783	0.39 in	9.9 mm	1.81 in	46.0 mm	1.69 in	42.9 mm	0.25 in	6.4 mm	1/2-13 NC	500 lb	226.8 kg	78.00
17784	0.65 in	16.5 mm	2.68 in	68.1 mm	2.31 in	58.7 mm	0.50 in	12.7 mm	3/4-10 NC	4000 lb	1814.4 kg	78.00
17785	0.78 in	19.8 mm	3.37 in	85.6 mm	3.00 in	76.2 mm	0.62 in	15.8 mm	1-8 NC	10,000 lb	4535.9 kg	78.00
17786	0.39 in	9.9 mm	1.81 in	46.0 mm	1.69 in	42.9 mm	0.25 in	6.4 mm	3/8-16 NC	500 lb	226.8 kg	78.00
17787	0.65 in	16.5 mm	2.68 in	68.1 mm	2.31 in	58.7 mm	0.50 in	12.7 mm	1/2-13 NC	2000 lb	907.2 kg	78.00
17788	0.65 in	16.5 mm	2.68 in	68.1 mm	2.31 in	58.7 mm	0.50 in	12.7 mm	5/8-11 NC	2500 lb	1134.0 kg	78.00
17789	0.78 in	19.8 mm	3.37 in	85.6 mm	3.00 in	76.2 mm	0.62 in	15.8 mm	3/4-10 NC	5000 lb	2268.0 kg	78.00
<b>Mild Steel with Pin:</b>												
17790	1.39 in	35.3 mm	4.12 in	104.6 mm	4.50 in	114.3 mm	1.00 in	25.4 mm	1 1/4-7 NC	15,000 lb	6803.9 kg	295.00
17791	1.22 in	31.0 mm	4.12 in	104.6 mm	5.00 in	127.0 mm	1.25 in	31.8 mm	1 1/2-6 NC	20,000 lb	9071.9 kg	295.00
<b>Stainless Steel with Pin:</b>												
33644	0.52 in	13.2 mm	2.38 in	60.5 mm	1.94 in	49.3 mm	0.38 in	9.5 mm	1/2-13 NC	300 lb	136.1 kg	155.00
33643	0.39 in	9.9 mm	1.81 in	46.0 mm	1.69 in	42.9 mm	0.25 in	6.4 mm	1/2-13 NC	500 lb	226.8 kg	155.00
33641	0.39 in	9.9 mm	1.81 in	46.0 mm	1.69 in	42.9 mm	0.25 in	6.4 mm	3/8-16 NC	500 lb	226.8 kg	155.00
33658	0.52 in	13.2 mm	2.38 in	60.5 mm	1.94 in	49.3 mm	0.38 in	9.5 mm	3/8-16 NC	500 lb	226.8 kg	155.00
33642	0.65 in	16.5 mm	2.68 in	68.1 mm	2.31 in	58.7 mm	0.50 in	12.7 mm	3/4-10 NC	4000 lb	1814.4 kg	205.00
33640	0.65 in	16.5 mm	2.68 in	68.1 mm	2.31 in	58.7 mm	0.50 in	12.7 mm	1/2-13 NC	2000 lb	907.2 kg	205.00
33639	0.65 in	16.5 mm	2.68 in	68.1 mm	2.31 in	58.7 mm	0.50 in	12.7 mm	5/8-11 NC	2500 lb	1134.0 kg	205.00
33638	0.78 in	19.8 mm	3.37 in	85.6 mm	3.00 in	76.2 mm	0.62 in	15.8 mm	3/4-10 NC	5000 lb	2268.0 kg	205.00

\*Do not exceed the safe load

# Load Cell Eye Bolts

## Standard Features

- One jam nut included with each eye bolt

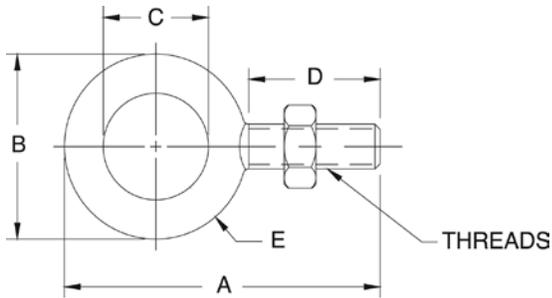

## Part Number/Price

PART #	A	B	C	D	E	THREAD SIZE	SAFE LOAD*	PRICE						
<b>Mild Steel:</b>														
17705	2.25 in	57.2 mm	1.25 in	31.8 mm	0.75 in	19.1 mm	1.00 in	25.4 mm	0.25 in	6.4 mm	1/4-28 NF	500 lb	226.8 kg	\$17.00
17707	2.91 in	73.9 mm	1.66 in	42.2 mm	1.00 in	25.4 mm	1.25 in	31.8 mm	0.33 in	8.4 mm	3/8-24 NF	1300 lb	589.7 kg	17.00
17709	3.56 in	90.4 mm	2.06 in	52.3 mm	1.19 in	30.2 mm	1.50 in	38.1 mm	0.44 in	11.2 mm	1/2-20 NF	2400 lb	1088.6 kg	20.00
17711	4.25 in	108.0 mm	2.50 in	63.5 mm	1.37 in	34.8 mm	1.75 in	44.5 mm	0.56 in	14.2 mm	5/8-18 NF	4000 lb	1814.4 kg	26.00
17713	4.81 in	122.2 mm	2.81 in	71.4 mm	1.50 in	38.1 mm	2.00 in	50.8 mm	0.66 in	16.8 mm	3/4-16 NF	5000 lb	2267.9 kg	57.00
17715	6.06 in	153.9 mm	3.56 in	90.4 mm	1.81 in	46.0 mm	2.50 in	63.5 mm	0.87 in	22.1 mm	1-12 NF	9000 lb	4082.3 kg	92.00
17716	6.06 in	153.9 mm	3.56 in	90.4 mm	1.81 in	46.0 mm	2.50 in	63.5 mm	0.87 in	22.1 mm	1-14 NS	9000 lb	4082.3 kg	92.00
17704	2.25 in	57.2 mm	1.25 in	31.8 mm	0.75 in	19.1 mm	1.00 in	25.4 mm	0.25 in	6.4 mm	1/4-20 NC	500 lb	226.8 kg	16.00
17706	2.91 in	73.9 mm	1.66 in	42.2 mm	1.00 in	25.4 mm	1.25 in	31.8 mm	0.33 in	8.4 mm	3/8-16 NC	1300 lb	589.7 kg	16.00
17708	3.56 in	90.4 mm	2.06 in	52.3 mm	1.19 in	30.2 mm	1.50 in	38.1 mm	0.44 in	11.2 mm	1/2-13 NC	2400 lb	1088.6 kg	18.00
17710	4.25 in	108.0 mm	2.50 in	63.5 mm	1.37 in	34.8 mm	1.75 in	44.5 mm	0.56 in	14.2 mm	5/8-11 NC	4000 lb	1814.4 kg	28.00
17712	4.81 in	122.2 mm	2.81 in	71.4 mm	1.50 in	38.1 mm	2.00 in	50.8 mm	0.66 in	16.8 mm	3/4-10 NC	5000 lb	2267.9 kg	46.00
17714	6.06 in	153.9 mm	3.56 in	90.4 mm	1.81 in	46.0 mm	2.50 in	63.5 mm	0.87 in	22.1 mm	1-8 NC	9000 lb	4082.3 kg	48.00
17717	7.44 in	189.0 mm	4.44 in	112.8 mm	2.19 in	55.6 mm	3.00 in	76.2 mm	1.12 in	28.4 mm	1 1/4-7 NC	15,000 lb	6803.9 kg	137.00

\*Do not exceed the safe load

Important: Read "Load Cell Mounting Hardware Safety Guidelines" at the beginning of this section.



# Rod End Ball Joints

## Standard Features

- Used in the ITCM assembly
- One jam nut included with each rod end ball joint
- Standard or PTFE-lined
- Optional stainless steel provides enhanced corrosion resistance for hostile environments



PTFE Lined Standard

## Part Number/Price

PART #	SAFE LOAD*	BREAKING STRENGTH	PTFE LINED	PRICE		
<b>Mild Steel:</b>						
17746	975lb	453.6 kg	3915lb	1913.3 kg	YES	\$28.00
17734	1200lb	544.3 kg	4916lb	2229.9 kg	NO	19.00
17736	4000lb	1814.4 kg	16,238lb	7365.5 kg	NO	55.00
17738	7000lb	3175.2 kg	28,081lb	12,737.4 kg	NO	93.00
17735	2000lb	907.2 kg	8075lb	3662.8 kg	NO	24.00
17737	3250lb	1474.2 kg	13,831lb	6273.7 kg	NO	36.00
17739	500lb	226.8 kg	2158lb	978.9 kg	YES	28.00
17740	4000lb	1814.4 kg	16,238lb	7365.5 kg	YES	49.00
17741	10,000lb	4535.9 kg	40,572lb	18,403.2 kg	YES	70.00
17742	10,500lb	4762.7 kg	43,541lb	19,749.9 kg	NO	135.00
26007	15,000lb	6803.9 kg	76,200lb	34,563.8 kg	YES	260.00
17747	19,000lb	8618.3 kg	76,200lb	34,563.8 kg	YES	325.00
17743	20,000lb	9071.9 kg	79,728lb	36,164.1 kg	NO	232.00
17744	24,000lb	10,886.2 kg	96,510lb	43,776.3 kg	NO	335.00
17745	55,000lb	24,947.7 kg	225,457lb	102,265.9 kg	NO	340.00
<b>Stainless Steel:</b>						
33506	1500lb	680.4 kg	7362lb	3339.4 kg	YES	125.00
33505	500lb	226.8 kg	2158lb	978.9 kg	YES	125.00
33507	3000lb	1360.8 kg	16,238lb	7365.5 kg	YES	135.00
33508	7,000lb	3175.2 kg	40,572lb	18,403.2 kg	YES	315.00

\*Do not exceed the safe load

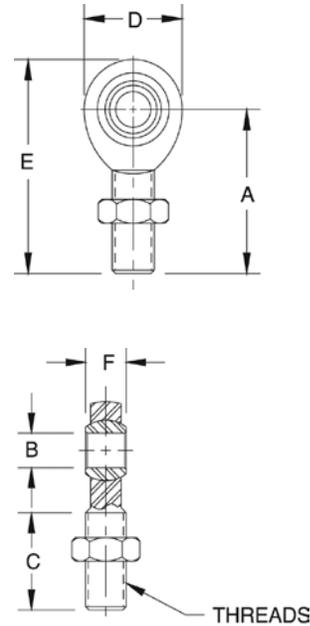

## Dimensions

PART #	A	B	C	D	E	F	THREAD SIZE
<b>Mild Steel:</b>							
17746	1.94 in	49.3 mm	0.37 in	9.4 mm	1.25 in	31.8 mm	1.00 in
17734	1.94 in	49.3 mm	0.37 in	9.4 mm	1.25 in	31.8 mm	1.00 in
17736	2.44 in	62.0 mm	0.50 in	12.7 mm	1.50 in	38.1 mm	1.31 in
17738	2.87 in	72.9 mm	0.75 in	19.1 mm	1.75 in	44.5 mm	1.75 in
17735	2.44 in	62.0 mm	0.50 in	12.7 mm	1.50 in	38.1 mm	1.31 in
17737	2.87 in	72.9 mm	0.75 in	19.1 mm	1.75 in	44.5 mm	1.75 in
17739	1.56 in	39.6 mm	0.25 in	6.4 mm	1.00 in	25.4 mm	0.75 in
17740	2.44 in	62.0 mm	0.50 in	12.7 mm	1.50 in	38.1 mm	1.31 in
17741	2.87 in	72.9 mm	0.62 in	15.8 mm	1.75 in	44.5 mm	1.75 in
17742	4.12 in	104.7 mm	1.00 in	25.4 mm	2.12 in	53.9 mm	2.75 in
26007	4.12 in	104.7 mm	1.00 in	25.4 mm	2.12 in	53.9 mm	2.75 in
17747	4.12 in	104.7 mm	1.00 in	25.4 mm	2.12 in	53.9 mm	2.75 in
17743	4.12 in	104.7 mm	1.25 in	31.8 mm	2.12 in	53.9 mm	2.75 in
17744	5.37 in	136.4 mm	1.50 in	38.1 mm	3.00 in	76.2 mm	3.50 in
17745	8.00 in	203.2 mm	2.00 in	50.8 mm	4.62 in	117.4 mm	5.00 in
<b>Stainless Steel:</b>							
33506	1.94 in	49.3 mm	.37 in	9.4 mm	1.25 in	31.8 mm	1.00 in
33505	1.56 in	39.6 mm	.25 in	6.4 mm	1.00 in	25.4 mm	.75 in
33507	2.44 in	62.0 mm	.50 in	12.7 mm	1.50 in	38.1 mm	1.31 in
33508	2.87 in	72.9 mm	.62 in	15.8 mm	1.75 in	44.5 mm	1.75 in

# Connecting Links

## Standard Features

- Drop-forged carbon steel, heat-treated, hot-dipped galvanized finish

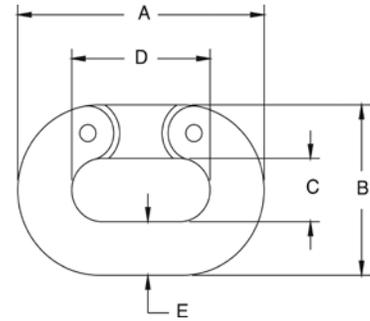

## Part Number/Price

PART #	A	B	C	D	E	SAFE LOAD*	PRICE						
17794	1.50 in	38.1 mm	1.00 in	25.4 mm	0.43 in	10.9 mm	0.87 in	22.1 mm	0.25 in	6.4 mm	1325 lb	601.6 kg	\$30.00
17795	2.06 in	52.3 mm	1.37 in	34.8 mm	0.56 in	14.2 mm	1.12 in	28.5 mm	0.37 in	9.4 mm	2750 lb	1247.4 kg	32.00
17796	2.65 in	67.3 mm	1.71 in	43.4 mm	0.65 in	16.5 mm	1.46 in	37.1 mm	0.50 in	12.7 mm	4750 lb	2154.6 kg	32.00
17797	3.31 in	84.1 mm	2.09 in	53.1 mm	0.78 in	19.8 mm	1.81 in	46.0 mm	0.62 in	15.8 mm	7250 lb	3288.6 kg	43.00
17798	3.87 in	98.3 mm	2.50 in	63.5 mm	0.93 in	23.6 mm	2.12 in	53.9 mm	0.75 in	19.1 mm	10,250 lb	4649.3 kg	60.00
17799	5.00 in	127.0 mm	3.31 in	84.1 mm	1.25 in	31.8 mm	2.75 in	69.9 mm	1.00 in	25.4 mm	15,500 lb	7030.7 kg	97.00

\*Do not exceed the safe load

# Load Cell Isolators

## Standard Features

- Power surges such as those caused by welding or electrical shorts frequently damage load cells and indicators. To PreVent such damage, these isolators electrically separate the mechanical assembly from its tension-type load cell.



## Part Number/Price

PART #	HEIGHT	THREAD SIZE	MAX. DIA	SAFE LOAD*	PRICE				
17722	3/8	16 NC	2.50	63.5 mm	2.50	63.5 mm	600 lb	272.2 kg	\$34.00
17724	1/2	13 NC	2.50	63.5 mm	2.50	63.5 mm	600 lb	272.2 kg	41.00
17726	1/2	20 NF	2.50	63.5 mm	2.50	63.5 mm	600 lb	272.2 kg	48.00
17725	1/2	13 NC	2.43	61.7 mm	2.00	50.8 mm	3000 lb	1360.8 kg	95.00
17723	3/8	24 NF	2.50	63.5 mm	2.50	63.5 mm	600 lb	272.2 kg	75.00
17728	1/2	13 NC x 1/2-20 NF	2.50	63.5 mm	2.50	63.5 mm	600 lb	272.2 kg	52.00
17732	1/4	20 NC	1.00	25.4 mm	1.12	28.4 mm	250 lb	113.4 kg	38.00

\*Do not exceed the safe load

# Threaded Adapters

## Standard Features

- For coupling isolators with load cells and steelyard rods
- Supplied with jam nuts
- Now in stronger, more durable stainless steel

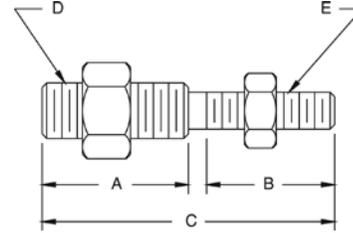

## Part Number/Price

PART #	A		B		C		D	E	SAFE LOAD*		PRICE
33561	—	—	—	—	2.00 in	50.8 mm	1/4-28 NF	1/4-28 NF	300 lb	136.1 kg	\$20.00
33562	0.94 in	23.9 mm	0.94 in	23.9 mm	2.00 in	50.8 mm	1/4-28 NF	1/4-20 NC	300 lb	136.1 kg	21.00
33563	0.92 in	23.3 mm	1.02 in	25.9 mm	2.06 in	52.3 mm	1/4-28 NF	3/8-24 NF	300 lb	136.1 kg	20.00
33564	0.94 in	23.9 mm	0.94 in	23.9 mm	2.00 in	50.8 mm	1/4-28 NF	3/8-16 NC	300 lb	136.1 kg	20.00
33565	1.06 in	26.9 mm	1.06 in	26.9 mm	2.25 in	57.2 mm	1/4-20 NC	3/8-16 NC	300 lb	136.1 kg	22.00
33567	1.06 in	26.9 mm	1.06 in	26.9 mm	2.25 in	57.2 mm	1/4-28 NF	1/2-13 NC	300 lb	136.1 kg	22.00
33568	—	—	—	—	2.00 in	50.8 mm	3/8-24 NF	3/8-24 NF	500 lb	226.8 kg	31.00
33569	0.91 in	23.1 mm	0.91 in	23.1 mm	2.00 in	50.8 mm	3/8-16 NC	3/8-24 NF	500 lb	226.8 kg	25.00
33570	1.06 in	26.9 mm	1.06 in	26.9 mm	2.25 in	57.2 mm	3/8-24 NF	1/2-13 NC	500 lb	226.8 kg	22.00
33571	1.31 in	33.3 mm	1.31 in	33.3 mm	2.75 in	69.9 mm	1/2-13 NC	5/8-11 NC	3000 lb	1360.8 kg	22.00
33572	0.87 in	22.0 mm	0.87 in	22.0 mm	2.00 in	50.8 mm	1/2-13 NC	1/2-20 NF	3000 lb	1360.8 kg	25.00
33573	—	—	—	—	2.06 in	52.3 mm	1/2-20 NF	1/2-20 NF	3000 lb	1360.8 kg	25.00
33574	1.31 in	33.3 mm	1.31 in	33.3 mm	2.75 in	69.9 mm	1/2-20 NF	5/8-11 NC	3000 lb	1360.8 kg	27.00
33575	1.31 in	33.3 mm	1.31 in	33.3 mm	3.00 in	76.2 mm	3/4-16 NF	3/4-10 NC	7000 lb	3175.2 kg	29.00

\*Do not exceed the safe load

Important: Read "Load Cell Mounting Hardware Safety Guidelines" at the beginning of this section.

## ITCM - Isolated Tension Cell Mount Hardware Kits

The Isolated Tension Cell Mount ITCM is a mounting assembly designed for tension mounting S-beam load cells in suspended hopper assemblies and mechanical scale conversions. The ITCM incorporates clevis and unique rod end ball joint assemblies to reduce the overall length to less than half of the traditional tension cell mounts, while providing correct load alignment. In addition, the load cell is completely electrically isolated from stray currents, a major cause of load cell failure. To complete the design, a grounding strap connects the two clevis assemblies to further guarantee safety to your load cells.

### Applications

- Suspended hoppers
- Mechanical scale conversions
- Replaces traditional eye bolt, isolator configurations
- Standard Features

### Standard Features

- Provides greater safety than traditional/suspension configurations
- Complete package for ease of installation
- Built-in electrical isolation without having to use isolators (not available on 20,000 lb/9071.9 kg version)
- Provides correct load cell loading even in difficult installations
- Dramatically reduces overall length
- Capacities from 100 lb/45.4 kg to 20,000 lb/9071.9 kg
- Clevis mounts with nylon insulating washers
- PTFE-lined rod end ball joints (not available on 20,000 lb/9071.9 kg version)
- Completely isolates load cell from stray currents
- Grounding strap for electrical continuity
- Zinc plated clevis

### Part Number/Price

PART #	LOAD RATING		CLEVIS THREAD	ROD END THREAD	*SAFELOAD		PRICE
<b>Mild Steel:</b>							
17968	300 lb	136.1 kg	3/8-16	3/8-24	300 lb	136.1 kg	\$185.00
17969	300 lb	136.1 kg	1/2-13	3/8-24	300 lb	136.1 kg	185.00
17894	500 lb	226.8 kg	3/8-16	1/4-28	500 lb	226.8 kg	185.00
17895	500 lb	226.8 kg	1/2-13	1/4-28	500 lb	226.8 kg	185.00
17896	2000 lb	907.2 kg	1/2-13	1/2-20	2000 lb	907.2 kg	210.00
17897	2500 lb	1134.0 kg	5/8-11	1/2-20	2500 lb	1134.0 kg	210.00
17898	4000 lb	1814.4 kg	3/4-10	1/2-20	4000 lb	1814.4 kg	210.00
17899	5000 lb	2268.0 kg	3/4-10	3/4-16	5000 lb	2268.0 kg	270.00
17900	10,000 lb	4535.9 kg	1-8	3/4-16	10,000 lb	4535.9 kg	270.00
17958	†15,000 lb	6803.9 kg	1 1/4-7	1-12	15,000 lb	6803.9 kg	1,015.00
63166	††15,000 lb	6803.9 kg	1 1/4-7	1-14	15,000 lb	6803.9 kg	955.00
17959	**20,000 lb	9071.9 kg	1 1/2-6	1 1/4-12	20,000 lb	9071.9 kg	915.00
<b>Stainless Steel:</b>							
33630	500 lb	226.8 kg	3/8-16	3/8-24	500 lb	226.8 kg	415.00
33631	300 lb	136.1 kg	1/2-13	3/8-24	300 lb	136.1 kg	415.00
33632	500 lb	226.8 kg	3/8-16	1/4-28	500 lb	226.8 kg	415.00
33633	500 lb	226.8 kg	1/2-13	1/4-28	500 lb	226.8 kg	415.00
33634	2000 lb	907.2 kg	1/2-13	1/2-20	2000 lb	907.2 kg	515.00
33635	2500 lb	1134.0 kg	5/8-11	1/2-20	2500 lb	1134.0 kg	515.00
33636	3000 lb	1360.8 kg	3/4-10	1/2-20	3000 lb	1360.8 kg	515.00
33637	5000 lb	2268.0 kg	3/4-10	3/4-16	5000 lb	2268.0 kg	915.00

Hardware kits do not include load cell

\*Do not exceed the safe load \*\* Not electrically isolated

† For use with RL20000-15,000 lb load cell †† For use with RL20001-15,000 lb load cell

Important: Read "Load Cell Mounting Hardware Safety Guidelines" at the beginning of this section.

Note: Replacement parts for mounts can be in the Replacement Parts Catalog.



Mount only - does not include load cell

# Grounding Strap

## Standard Features

- Used in the ITCM assembly
- Tinned copper braid
- Crimped sleeve on ends with .25in (6.4 mm) hole
- Available in 12 in (304.8 mm), 14 in (355.6 mm), 16 in (406.4 mm), 24 in (609.6 mm) or 32 in (812.8 mm) lengths

## Part Number/Price

PART #	LENGTH		PRICE
17778	12 in	(304.8 mm)	\$10.25
17779	14 in	(355.6 mm)	12.00
17780	16 in	(406.4 mm)	13.00
17781	24 in	(609.6 mm)	13.25
17782	32 in	(812.8 mm)	21.50



Important: Read "Load Cell Mounting Hardware Safety Guidelines" at the beginning of this section.

# Load Receiver Plate

## Standard Features

- Design offers accurate point loading
- Self-centering effect built in
- Ease of manufacture for custom applications
- Use with load cup and ball bearings to build a custom scale
- Ball and cup load introduction provides point loading for maximum accuracy
- Stainless steel construction

## Part Number/Price

PART #	DESCRIPTION	PRICE
18832	Load receiver plate	\$45.00 each

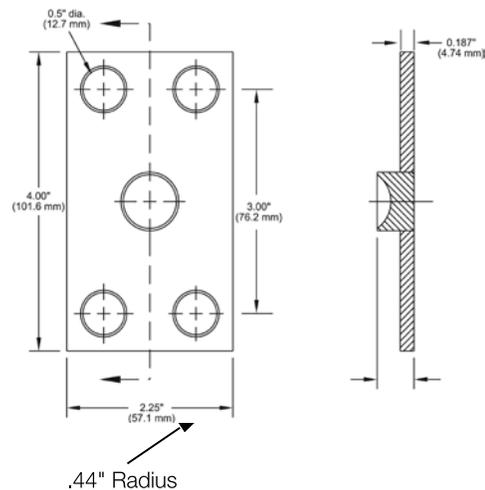
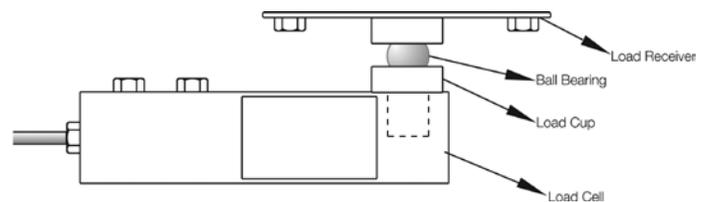
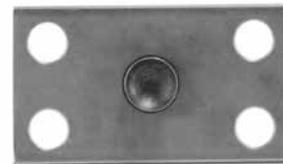

# Ball Bearings

## Standard Features

- Use with load cup and load receiver to build a custom scale
- 52100 chrome alloy steel

## Part Number/Price

PART #	DRAWING DIMENSIONS	PRICE
18815	5/8 in diameter crush strength 32,000 lbs	\$14.00
18816	7/8 in diameter crush strength 59,000 lbs	16.00
65841	1.25 in diameter crush strength 100,00 lbs	27.00



# Load Cups

## Standard Features

- Ball and cup load introduction provides point loading for maximum accuracy
- For use with most popular single-ended beams

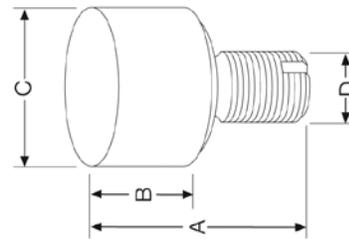

## Part Number/Price

PART #	A		B		C		D		PRICE
31911	1.70 in	43.2 mm	0.54 in	13.7 mm	1.07 in	27.2 mm	1/2-20 NF	\$45.00	
33654	1.12 in	28.4 mm	0.54 in	13.7 mm	0.78 in	19.8 mm	1/2-20 NF	31.00	
33653	1.50 in	38.1 mm	0.80 in	20.3 mm	1.12 in	28.4 mm	3/4-16 NF	33.00	
33652	2.00 in	50.8 mm	0.85 in	21.6 mm	1.75 in	44.5 mm	1-12 NF	80.00	
33651	2.85 in	72.4 mm	0.85 in	21.6 mm	1.75 in	44.5 mm	1-12 NF	115.00	
33650	2.85 in	72.4 mm	0.85 in	21.6 mm	1.75 in	44.5 mm	1-14 NF	115.00	
33647	2.75 in	69.9 mm	0.50 in	12.7 mm	0.75 in	19.1 mm	1/2-20 NF	39.00	
72364	1.78 in	45.2 mm	0.53 in	13.4 mm	0.78 in	19.8 mm	1/2-20 NF	55.00	
69431	Replacement cup for Cardinal SCA-50 K load cell								54.00

# Cardinal® Wire Rope Replacement Assemblies

## Standard Features

- EL208 Cardinal wire rope assembly. Used on 7500 lb (3402.0 kg) capacity FH model and 8000 lb (3628.7 kg) capacity EP model.
- EL209 Cardinal wire rope assembly. Used on 20,000 lb (9071.9 kg) capacity FH and EP models. May also be used on 15,000 lb (6803.9 kg) capacity FH and EP models.

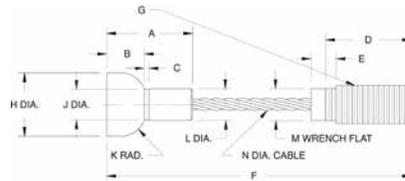

Part # 17767 EL209



## Custom Wire Ropes

### Standard Features

- Custom wire ropes are available for your specific applications
- When ordering, please supply us with the specifications listed at right, a sample if possible, the required tension rating and total capacity

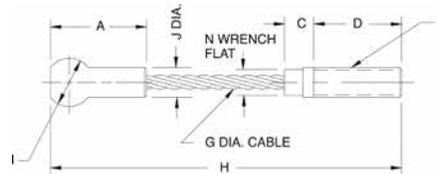

Part # 17763 EL208



### Part Number/Price

PART #	A	B	C	D	E	F	G	H	I	J	K	L & M	N	PRICE
17763	1.50 in	-	0.50 in	1.50 in	-	1/2-13NC in	0.25 in	6.00 in	0.81 in	0.43 in	-	-	0.43 in	\$65.00
	38.1 mm	-	12.7 mm	38.1 mm	-	-	6.4 mm	152.4 mm	20.6 mm	10.9 mm	-	-	10.9 mm	
17767	1.71 in	0.75 in	0.09 in	2.00 in	0.43 in	6.31 in	3/4-10 UNC-2A in	1.25 in	-	0.60 in	0.50 in	0.625 in	0.375 in	95.00
	43.4 mm	19.1 mm	2.3 mm	50.8 mm	10.9 mm	160.3 mm		31.8 mm	-	15.2 mm	12.7 mm	15.9 mm	9.5 mm	

Important: Read "Load Cell Mounting Hardware Safety Guidelines" at the beginning of this section.

## Wire Rope Assemblies

### Standard Features

- Wire rope assemblies provide better alignment and greatly increase load cell repeatability. In addition, they act as natural vibration dampeners.

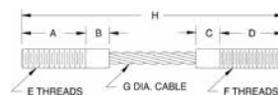
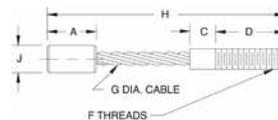

### Part Number/Price

PART #	A	B & C	D	E	F	G	H	SAFE LOAD*	PRICE
17760	0.87 (22.1)	0.50 (12.7)	0.87 (22.1)	1/4-20 NC-2A	1/4-28 NF-2A	0.12 (3.1)	4.00 (101.6)	400 lb (181.4 kg)	\$45.00
17762	1.25 (31.8)	0.50 (12.7)	1.25 (31.8)	3/8-16 NC-2A	3/8-24 NF-2A	0.18 (4.6)	5.00 (127.0)	850 lb (385.6 kg)	53.00
17766	1.62 (41.1)	0.50 (12.7)	1.62 (41.1)	1/2-13 NC-2A	1/2-20 NF-2A	0.25 (6.4)	6.50 (165.1)	1400 lb (635.0 kg)	56.00
17765	1.62 (41.1)	0.50 (12.7)	1.62 (41.1)	1/2-13 NC-2A	1/2-20 NF-2A	0.25 (6.4)	5.50 (139.7)	1400 lb (635.0 kg)	65.00
17764	1.00 (25.4)	-	1.37 (34.8)	1/2-20 NF-2A	1/2-20 NF-2A	0.25 (6.4)	4.00 (101.6)	1400 lb (635.0 kg)	85.00
17768	2.00 (50.8)	-	2.50 (63.5)	3/8-24 NF-2A	3/8-24 NF-2A	0.12 (3.1)	5.50 (139.7)	400 lb (181.4 kg)	125.00
17769**	1.25 (31.8)	-	0.75 (19.1)	1/4-28 NF-2A	1/4-28 NF-2A	0.12 (3.1)	3.00 (76.2)	400 lb (181.4 kg)	78.00
17771**	1.25 (31.8)	-	0.75 (19.1)	1/2-20 NF-2A	1/2-20 NF-2A	0.25 (6.4)	3.00 (76.2)	1400 lb (635.0 kg)	60.00
115292***	1.25 (31.8)	-	0.75 (19.1)	1/4-28 NF-2A	1/4-28 NF-2A	0.12 (3.1)	3.00 (76.2)	400 lb (181.4 kg)	80.00
33084****	1.31 (33.2)	-	1.00 (25.4)	1/2-20NF	1/2-20NF	0.125 (3.1)	3.00 (76.2)	850 lb (385.6 kg)	75.00

\*Do not exceed the safe load

\*\*Used with Rice Lake Weighing Systems Flexure Bases

\*\*\*Stainless Steel

\*\*\*\*Used with Rice Lake Weighing Systems FXB Flexure Bases

# Custom Wire Rope Definition

Customer's Name: \_\_\_\_\_

Contact Person: \_\_\_\_\_

Date: \_\_\_\_\_

Application: \_\_\_\_\_

WIRE ROPE*		
A Thread Length	F Threads	K Safe Load
B Shank Length	G Rope Diameter	L Environment
C Shank Length	H Overall Length	M Application
D Thread Length	I Ball Diameter	
E Threads	J Shank Diameter	

\*Use drawings below for reference

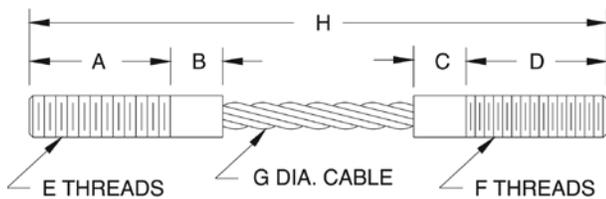
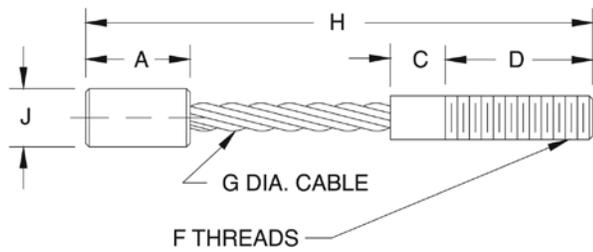
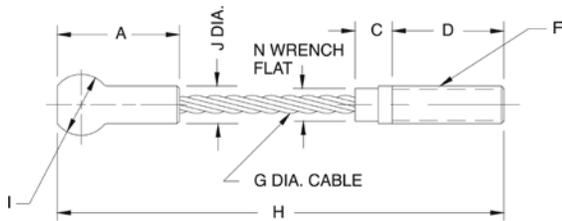
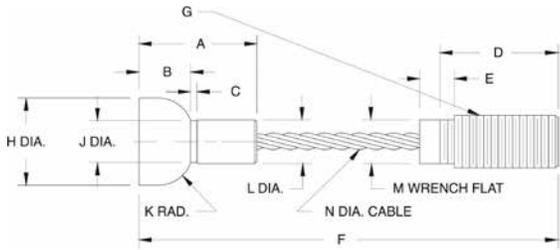



# Spherical Washer Sets

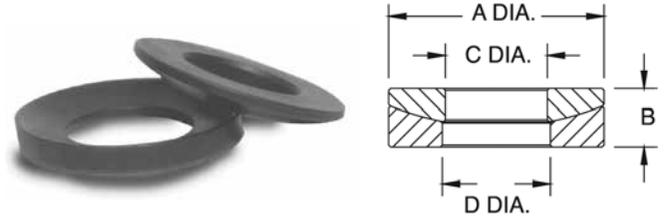

## Part Number/Price

PART #	BOLT SIZE	A	B	C	D	PRICE
<b>Mild Steel:</b>						
15196	0.25 in	6.4 mm	0.62 in	15.8 mm	0.20 in	5.1 mm
15197	0.38 in	9.7 mm	0.88 in	22.4 mm	0.25 in	6.4 mm
15198	0.50 in	12.7 mm	1.12 in	28.5 mm	0.31 in	7.9 mm
15199	0.62 in	15.8 mm	1.38 in	35.1 mm	0.31 in	7.9 mm
15200	0.75 in	19.1 mm	1.62 in	41.1 mm	0.38 in	9.7 mm
15201	1.00 in	25.4 mm	2.00 in	50.8 mm	0.50 in	12.7 mm
15202	1.25 in	31.8 mm	2.62 in	66.6 mm	0.50 in	12.7 mm
15203	1.50 in	38.1 mm	2.88 in	73.2 mm	0.53 in	13.5 mm
15205	2.00 in	50.8 mm	3.88 in	98.6 mm	0.81 in	20.6 mm
<b>Stainless Steel:</b>						
33218	0.50 in	12.7 mm	1.12 in	28.5 mm	0.31 in	7.9 mm
33220	0.75 in	19.1 mm	1.62 in	41.1 mm	0.38 in	9.7 mm

# Weldless End Links

## Standard Features

- Self colored or hot-dip galvanized
- Forged carbon steel—quenched and tempered

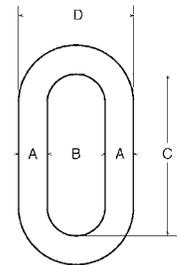

## Part Number/Price

PART #	A	B	C	D	SAFE LOAD*	PRICE
F312L	0.625 in	15.9 mm	1.00 in	25.4 mm	3.25 in	82.6 mm
17810	0.875 in	22.2 mm	2.00 in	50.8 mm	5.13 in	130.3 mm
21911	1.00 in	22.2 mm	2.25 in	57.2 mm	5.75 in	146.1 mm
65430	1.25 in	31.8 mm	2.50 in	63.5 mm	7.00 in	177.8 mm
21912	1.375 in	34.9 mm	2.75 in	69.9 mm	7.75 in	196.9 mm

\*Do not exceed the safe load

# Load Cell Spacers

## Standard Features

- Use with most popular single-ended beams
- Provides flat mounting surface required for optimum load cell performance
- Zinc-plated mild steel or stainless steel

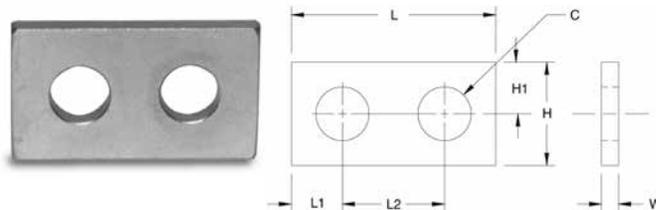

## Part Number/Price

PART #	C	H	H1	L	L1	L2	W	PRICE
<b>Mild Steel:</b>								
17754	0.53 in	13.4 mm	1.25 in	31.8 mm	0.62 in	15.7 mm	2.25 in	\$22.00
17755	0.78 in	19.8 mm	1.50 in	38.1 mm	0.75 in	19.1 mm	3.00 in	22.00
17756	1.03 in	26.2 mm	2.00 in	50.8 mm	1.00 in	25.4 mm	4.00 in	23.00
18260	0.53 in	13.4 mm	1.25 in	31.8 mm	0.62 in	15.7 mm	2.25 in	25.00
<b>Stainless Steel:</b>								
17757	0.78 in	19.8 mm	1.50 in	38.1 mm	0.75 in	19.1 mm	3.00 in	30.00
18383	0.53 in	13.4 mm	1.25 in	31.8 mm	0.62 in	15.7 mm	2.25 in	26.00
18411	0.53 in	13.4 mm	1.25 in	31.8 mm	0.62 in	15.7 mm	2.25 in	25.00

# Load Button

## Standard Features

- Suitable for use with compression mounting assemblies, canisters, S-beams and single-ended beams
- Hardened alloy steel

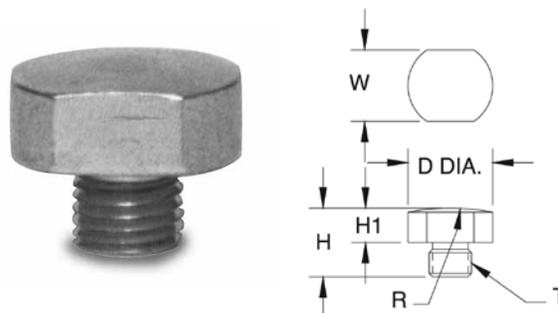

## Part Number/Price

PART #	T	D	H	H1	R	W	PRICE					
17750	3/8-24 UNF	0.75 in	19.1 mm	0.60 in	15.2 mm	0.30 in	7.6 mm	2.00 in	50.8 mm	0.63 in	16.0 mm	\$30.00
17751	1/2-20 UNF	0.75 in	19.1 mm	0.70 in	17.8 mm	0.30 in	7.6 mm	4.00 in	101.6 mm	0.63 in	16.0 mm	24.00
17752	3/4-16 UNF	1.50 in	38.1 mm	0.90 in	22.9 mm	0.30 in	7.6 mm	6.00 in	152.4 mm	1.25 in	31.8 mm	41.00

# Load Button Insert Kit

## Standard Features

- To be used with RLSSB and RTISSB load cells (1 k-5 k)
- Hardened alloy steel

## Part Number/Price

PART #	DESCRIPTION	PRICE
26112	Load button insert kit	\$30.00

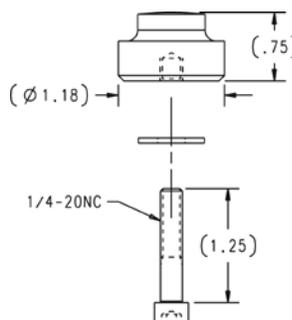

### Standard Features

- Replacement foot, adapts to most floor scales
- Use with single-ended beams to provide large, flat, adjustable introduction surface
- Special neoprene rubber sandwich base gives high accuracy, linearity and repeatability



### Part Number/Price

PART #	MATERIAL	THREAD SIZE	BASE HT.		TOTAL HT.		DIAMETER		PRICE
18756	Stainless Steel	1/2-20 UNF	0.75 in	19.1 mm	2.62 in	66.5 mm	3.47 in	88.1 mm	\$45.00
39021	Mild Steel	3/4-16 UNF-2B	0.875 in	22.3 mm	3.25 in	82.3 mm	4.40 in	111.76 mm	86.00
39022	Mild Steel	3/4-16 UNF-2B	0.875 in	22.3 mm	4.06 in	103.1 mm	5.40 in	137.16 mm	125.00
110930	Mild Steel	1-14 UNF	1.0 in	25.4 mm	4.06 in	103.1 mm	5.40 in	137.16 mm	180.00
42130	Stainless Steel	M12			2.62 in	67 mm	3.47 in	88.1 mm	95.00

## Flintec™ Adjustable Rubber Foot

### Standard Features

- Designed for platform scales containing Flintec SLB load cell
- Blind hole introduction
- Low profile
- Height adjustable by rotation
- Including spacer
- Stainless Steel



### Part Number/Price

PART #	FOOT DIAMETER		LOAD CELL CAPACITY	PRICE
<b>Flintec SLB, SB4, SB5, SB14 and SB6</b>				
46230	2.36 in	60 mm	200-500 lb	\$56.00
77561	3.14 in	80 mm	1000-5000 lb	56.00
<b>Flintec BK2</b>				
87096	3.140 in	80 mm	200 kg-2000 kg	56.00

# Bench Scale Feet

## Standard Features

*Rubber Pad*

- 1/4-20NC threads

*Stainless Steel*

- 3/8-16 threads



## Part Number/price

PART #	DESCRIPTION	PRICE
<b>Rubber Pad</b>		
35128	Bench Scale Feet	\$12.75
107476	CW 90/CW 90X Feet	19.00
<b>Stainless Steel</b>		
19141	Bench Scale Feet	5.50

# Polyurethane Rubber Leveling

## Standard Features

- 3 in (76.2mm) overall height, all diameters
- Stainless steel stem for corrosion resistance
- Heavy-duty construction, low cost replacement feet
- Four standard diameters all with 1/2-20 UNF SS stud, slotted for top-access applications
- Zinc plated carbon steel jam nut provided
- Top of stud is machined undersize 10% for easy alignment into load cell



## Part Number/Price

PART #	FOOT DIAMETER	HEIGHT	PRICE
74585	1.87 in	3 in	\$28.00
74586	2.00 in	3 in	28.00
74587	2.50 in	3 in	28.00
73801	3.00 in	3 in	28.00

# Captured Ball Floor Scale Leveling Feet

## Standard Features

### Carbon Steel

- Bright zinc and clear chromate plating for corrosion-resistance
- Active ball suspension provides ideal load cell loading with maximum side load protection
- Hardened alloy steel with plated finish
- Includes two jam nuts, one for wrench access
- Top of stud is machined undersize 10% for easy alignment into load cell plus slotted for top-access applications

### Stainless Steel

- Provides outstanding accuracy, repeatability and performance
- Active ball suspension provides optimum load cell performance
- Hardened stainless steel material, welded, with polished finish
- Includes two stainless steel jam nuts, one for wrench access
- Top of stud is machined undersize 10% for easy alignment into load cell plus slotted for top-access applications



Carbon



Stainless Steel

## Part Number/Price

PART #	FOOT DIA.	THREAD SIZE INCHES	HEIGHT	PRICE
<b>Carbon Steel</b>				
74578	1.87 in	1/2-20 UNF	3.5 in	\$40.00
74579	2.00 in	1/2-20 UNF	3.5 in	40.00
74580	2.50 in	1/2-20 UNF	3.5 in	40.00
74581	3.00 in	1/2-20 UNF	3.5 in	40.00
74582	3.00 in	3/4-16 UNF	4.5 in	50.00
74583	3.00 in	1-12 UNF	4.5 in	60.00
74584	3.00 in	1-14 UNF	4.5 in	60.00
<b>Stainless Steel</b>				
74572	1.87 in	1/2-20 UNF	3.5 in	58.00
74573	2.00 in	1/2-20 UNF	3.5 in	58.00
73800	2.50 in	1/2-20 UNF	3.5 in	58.00
74574	3.00 in	1/2-20 UNF	3.5 in	58.00
74575	3.00 in	3/4-16 UNF	4.5 in	68.00
74576	3.00 in	1-12 UNF	4.5 in	88.00
74577	3.00 in	1-14 UNF	4.5 in	88.00
*92380	2.50 in	1/2-20 UNF	3.5 in	58.00

\*Stem is fully threaded

# Leveling Pads

## Standard Features

- Replacement feet, adapt to most floor scales
- Available in cadmium-plated steel or stainless steel
- Simple “swivel” design
- Use with single-ended shear beams or bending beams to provide a large, flat load introduction surface



## Part Number/Price

PART #	THREAD SIZE	HEIGHT	DIAMETER	PRICE
<b>Mild Steel:</b>				
18817	1/2-13 NC	1.12 in	1.87 in	\$25.00
18820	3/4-10 NC	1.50 in	3.00 in	44.00
<b>Stainless Steel:</b>				
18818	1/2-13 NC	1.12 in	1.87 in	59.00
18833	3/4-10 NC	1.50 in	3.00 in	103.00

Used in conjunction with Leveling Pad Stems

# Leveling Mount

## Standard Features

- Designed for use with some floor scales or machinery platforms.
- Can be used as a replacement foot on the “SP” floor scale to limit vibrations transmitted to the scale through the floor
- Provides vibration isolation on most portable platforms



## Part Number/Price

PART #	THREAD SIZE	HEIGHT	DIAMETER	PRICE
18819	1/2-13 NC	1.81 in	5.00 in	\$100.00

# Leveling Pad Stems

## Standard Features

- For use with leveling pads
- One jam nut included

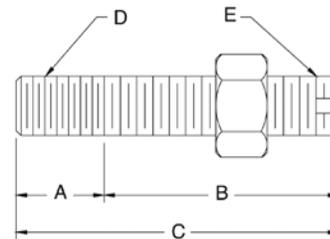

## Part Number/Price

PART #	A	B	C	D	E	SLOT	MATERIAL	PRICE
<b>Mild Steel:</b>								
17693	0.75 in	19.1 mm	2.00 in	50.8 mm	2.75 in	69.9 mm	3/4-10 NC 3/4-16 NF NO	1045 \$16.00
<b>Stainless Steel:</b>								
17689	0.50 in	12.7 mm	1.50 in	38.1 mm	2.00 in	50.8 mm	1/2-13 NC 1/2-20 NF YES	SS 16.00
17695	0.75 in	19.1 mm	2.00 in	50.8 mm	2.75 in	69.9 mm	3/4-10 NC 3/4-16 NF NO	SS 30.00

Used in conjunction with Leveling Pad

Warning: Do not use to suspend a load

# RoughDeck® Scale Base

## Standard Features

- Secures RoughDeck® and other popular floor scales
- PreVents movement in horizontal plane
- Useful with Surefoot™ and other load cell foot assemblies
- Available in stainless steel and mild steel

## Part Number/Price

PART #	MTL.	C	C1	H	H1	H2	PRICE
19075	MS	3.62 in	0.56 in	4.50 in	2.25 in	0.50 in	\$15.00
19076	SS	3.62 in	0.56 in	4.50 in	2.25 in	0.50 in	18.00

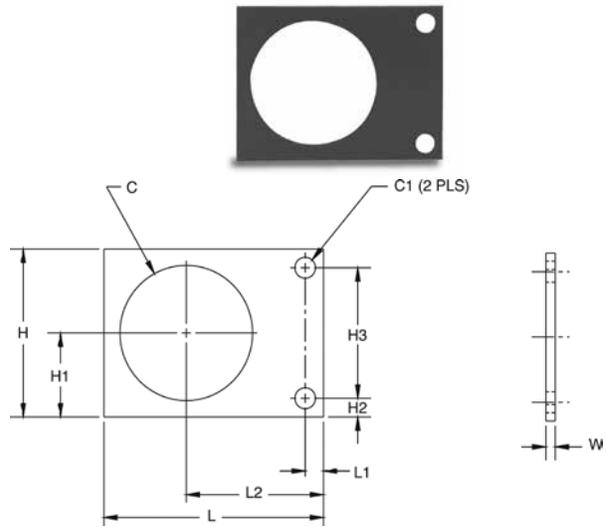

# Summit® 3000 Scale Base

## Standard Features

- Mounting plate for Summit® 3000 floor scales
- Available in mild steel painted green

## Part Number/Price

PART #	MTL.	C	C1	H	H1	PRICE
76149	MS	3.19 in	0.56 in	4.50 in	2.25 in	\$15.00

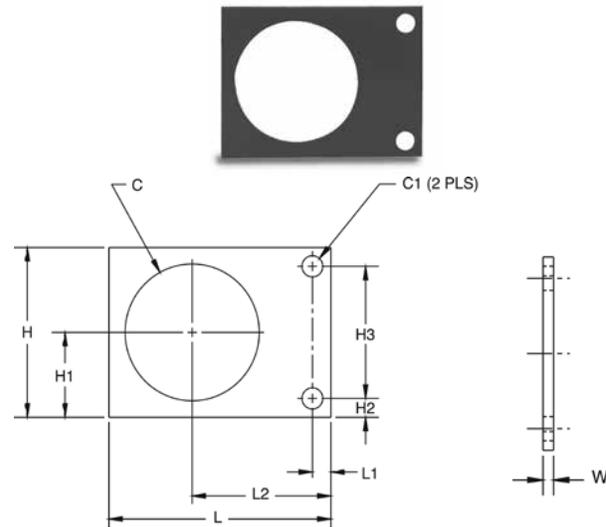

# Floor Scale

## Standard Features

- Suitable for use with leveling pads
- Generic mounting plate for popular floor scales
- Fits most floor scale foot assemblies
- Available in stainless steel and mild steel (mild steel parts are zinc plated/painted)

## Part Number/Price

PART #	C	C1	H	H1	H2	H3	PRICE
<b>Mild Steel:</b>							
18737	2.00 in	0.53 in	4.00 in	2.00 in	0.50 in	3.00 in	\$8.00
18738	3.25 in	0.81 in	5.00 in	2.50 in	0.75 in	3.50 in	9.00
<b>Stainless Steel:</b>							
18751	2.00 in	0.53 in	4.00 in	2.00 in	0.50 in	3.00 in	32.00

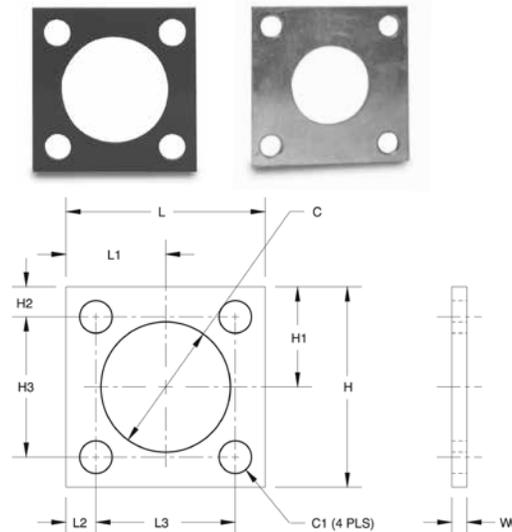

# Complete Custom Cable Services

## Standard Features

- Special cable requirements
- Custom-built cable designed specifically for your application.
- Choose from the following design elements and Rice Lake Weighing Systems will build a cable to your specifications.
- Quick turnaround
- Competitively priced
- 5000 ft minimum purchase

## Specifications

### Jacket Material:

- PVC
- Polyurethane
- Double-jacketed

### Conductors:

- Unlimited number
- Twisted pairs
- Color code
- Gauge

### Shielding:

- Braided
- Foil

### Jacket Colors:

- Black, brown, green, orange, red, blue, yellow, gray, natural

### Ink Colors:

- Black, white, silver, orange
- Custom logos

### Approvals:

- UL listed
- CSA

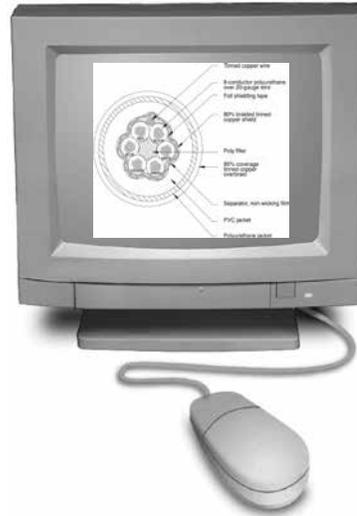



# EL147RP Plus

## Rodent Protection Cables

### Standard Features

- Tinned copper overbraid provides superior rodent and abrasion deterrent
- Enhanced EMI/RFI protection
- 6-conductor industry-standard color code
- Ideal for truck and railroad-track scales
- Diameter: 0.33 in (8.38 mm)
- Temperature rating -22°F to 126°F (-30°C to 80°C)
- Jacket coating enhanced with a chemical coating "NAW" that is distasteful to rodents

### Part Number/Price

PART #	CONTINUOUS ROLL	DESCRIPTION	PRICE
31475	Custom length	6-Conductor Hostile Environment Cable	\$3.50/ft
131964	100 ft 30.5 m	6-Conductor Hostile Environment Cable	325.00
131965	250 ft 76.2 m	6-Conductor Hostile Environment Cable	810.00
131966	500 ft 152.4 m	6-Conductor Hostile Environment Cable	1,615.00
131967	1000 ft 304.8 m	6-Conductor Hostile Environment Cable	2,995.00

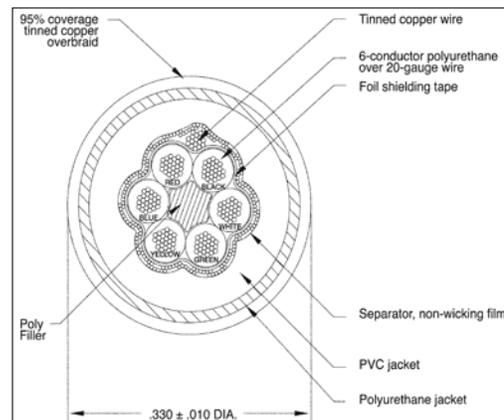
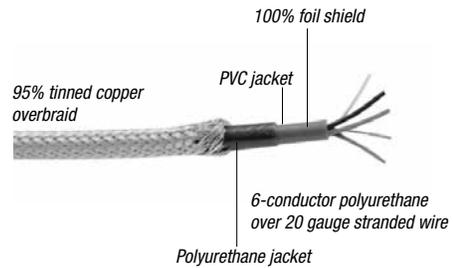

EL147RP Plus

# Hostile Environment Load Cell Cable

## Standard Features

- EL146HE—4-Wire Load Cell Cable
- EL147HE—6-Wire Load Cell Cable
- Designed for use in hostile environments
- Polyurethane jacketing provides superior chemical and abrasion resistance
- RFI and EMI protected with foil overbraid shield
- Unmatched durability, yet extremely flexible
- All conductors are industry-standard color coded
- Diameter—EL146HE: 0.28 in (7.1 mm); EL147HE: 0.32 in (8.1 mm)
- The 6-wire cable is best suited for longer runs where remote sense lines can be used
- Use the 4-wire cable for repairing or extending existing cable
- Temperature rating: -22°F to 126°F (-30°C to 80°C)
- 500V rating

## Part Number/Price

PART #	CONTINUOUS ROLL	DESCRIPTION	PRICE
15510	100 ft 30.5 m	4-Conductor Hostile Environment Cable	\$150.00
15511	250 ft 76.2 m	4-Conductor Hostile Environment Cable	375.00
15512	500 ft 152.4 m	4-Conductor Hostile Environment Cable	725.00
15513	1000 ft 304.8 m	4-Conductor Hostile Environment Cable	1,395.00
15494	Custom Length	4-Conductor Hostile Environment Cable	1.55/ft
15520	100 ft 30.5 m	6-Conductor Hostile Environment Cable	225.00
15521	250 ft 76.2 m	6-Conductor Hostile Environment Cable	550.00
15522	500 ft 152.4 m	6-Conductor Hostile Environment Cable	1,050.00
15523	1000 ft 304.8 m	6-Conductor Hostile Environment Cable	1,895.00
15496	Custom Length	6-Conductor Hostile Environment Cable	2.35/ft

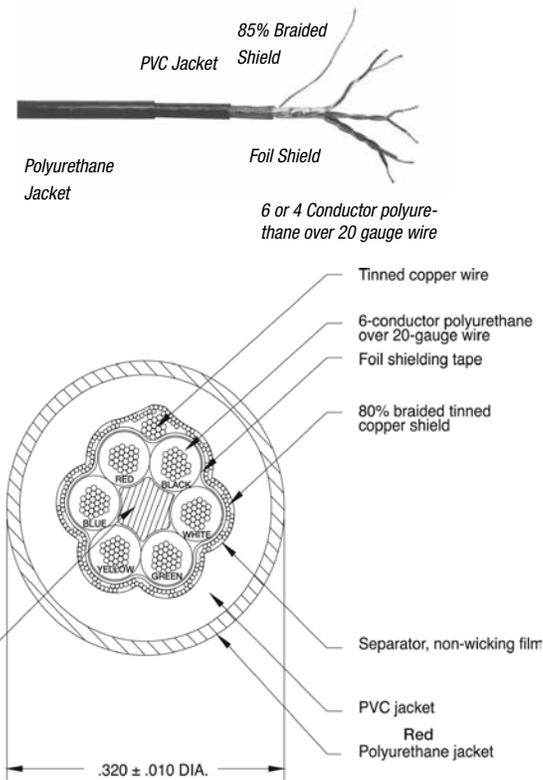

# Standard Load Cell Cable

## Standard Features

- EL146—4-Wire Load Cell Cable
- EL147—6-Wire Load Cell Cable
- 20 AWG tinned copper wire stranded for flexibility
- Braided shielding is encased in red PVC
- All conductors are industry-standard color coded
- Diameter—EL146: 0.25 in (6.4 mm); EL147: 0.29 in (7.4 mm)
- The 6-wire cable is best suited for longer runs where remote sense lines can be used
- Use the 4-wire cable for repairing or extending existing cable
- Temperature rating: -22°F to 126°F (-30°C to 80°C)

## Part Number/Price

PART #	CONTINUOUS ROLL	DESCRIPTION	PRICE
15505	100 ft 30.5 m	4-Conductor Cable	\$120.00
15506	250 ft 76.2 m	4-Conductor Cable	275.00
15507	500 ft 152.4 m	4-Conductor Cable	550.00
15508	1000 ft 304.8 m	4-Conductor Cable	895.00
15493	Custom Length	4-Conductor Cable	1.25/ft
15515	100 ft 30.5 m	6-Conductor Cable	185.00
15516	250 ft 76.2 m	6-Conductor Cable	435.00
15517	500 ft 152.4 m	6-Conductor Cable	825.00
15518	1000 ft 304.8 m	6-Conductor Cable	1,595.00
15495	Custom Length	6-Conductor Cable	1.95/ft

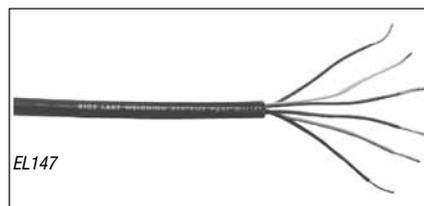
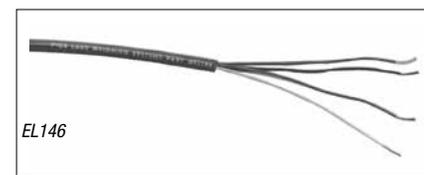

## APPROVALS



# EL147IS Hazardous Environment Blue Jacket Cable

## Standard Features

- Designed for intrinsically safe applications (must be wired according to Factory Mutual System-approved diagram)
- Polyurethane over PVC double jacketing provides superior chemical and abrasion resistance
- Both foil and braided wire shields for added RFI and EMI protection
- 6 conductors are industry-standard color coded (Also available 3 conductor)
- Diameter - 0.32in (8.1 mm)
- Suited for longer runs where remote sense lines can be used
- Temperature rating: -22°F to 126°F (-30°C to 80°C)

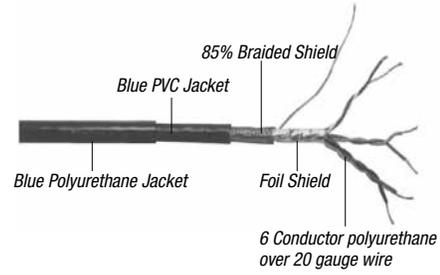

## Part Number/Price

PART #	DESCRIPTION	PRICE
32817	EL147IS, 6 conductor	\$2.85/ft
72241	HE blue jacket, shielded 3 conductor	2.25/ft

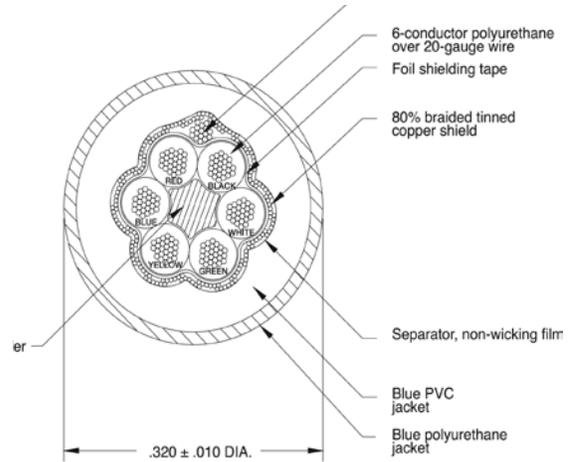

# EL144 Communications Cable

## Standard Features

- 2-conductor with bare ground
- RFI/EMI protected with foil shield
- 20 gauge conductors
- Perfect for RS-232, 2-wire RS-485, and 20 mA current loop communications
- Diameter: 0.19in(4.8mm)

## Part Number/Price

PART #	DESCRIPTION	PRICE
32803	EL144	\$0.85/ft
72691	100 ft	75.00
72072	EL144, 500 ft	395.00
72693	EL144, 1000 ft	695.00



# BCD Cable

## Standard Features

- Sheathed in gray PVC
- Mylar aluminum foil shield with stranded tinned copper drain wire
- Diameter: 0.375in (9.5 mm)

## Part Number/Price

PART #	DESCRIPTION	PRICE
15497	BCD, 24 AWG, 30-conductor	\$21.00/ft

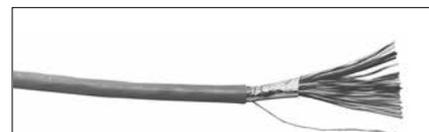

## Fiber Optic Cable

### Standard Features

- Duplex cable polyethylene black jacket material
- 4.4 + 0.10 mm outer diameter of duplex cable
- 2.2 + 0.007 mm single cable outer diameter
- Operating temperature: 32°F to 158°F (-55°C to 70°C)

### Part Number/Price

PART #	DESCRIPTION	PRICE
78910	Custom length	\$1.35/ft
78026	100 ft cable (30.48 m)	135.00
78027	200 ft cable (60.96 m)	270.00
78028	300 ft cable (91.44 m)	405.00
83052*	Fiber optic connector	40.00
80892	Fiber optic cable cutter	9.00
85548	Fiber optic hot knife	48.00

\*Duplex fiber cable requires two connectors

\*Maximum guaranteed transmission distance when used with the 320IS/IO Module is 240'



Color Code: Black-TXD, Blue-RXD

## SURVIVOR® EL620HE High Temperature Cable

### Standard Features

- Multiconductor overall foil and braid shield
- Suitable for temperatures from -40°C to 200°C (392°F)
- Insulation thickness - 0.010 in (0.25 mm)
- Jacket thickness - 0.017 in (0.43 mm)
- 18 gauge, tinned copper conductors
- 6 wire or 6 conductor
- FEP jacket, resistant to chemical corrosion and high temperature
- Aluminum-polyester shield with 85% tinned copper braid shield
- 150V NEC 725 Class 2 classified for use in an airplenum non-conduit
- 0.24 in diameter cable

### Part Number/Price

PART #	DESCRIPTION	PRICE
15605	EL620HE	\$9.75/ft



## SURVIVOR® Cable Armor

### Standard Features

- Flexible all metal protective armor
- Ideal for protecting load cell cable from mechanical abrasion or rodents
- Available in stainless steel and galvanized steel
- 0.5 in (12.7 mm) internal diameter, 2.0 in (50.8 mm) minimum bend radius
- Optional end fitting with 1/2 in male pipe thread

### Part Number/Price

PART #	DESCRIPTION	PRICE
17808	Galvanized steel	\$3.55/ft
17806	Stainless steel	4.30/ft
17807	Optional end fitting	1.95 each

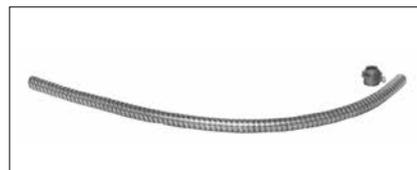

# EL148 HE Replacement Mettler Toledo® Power Cell® Cable

## Standard Features

- 100% stainless steel military connector-electro deposited nickel plating with stainless banding and epoxy heat-shrink strain relief
- Stainless steel artic ring precision cut for improved connection
- Textured rubber boot for additional grip
- Standard Mettler Toledo color code
- Custom lengths available including standard lengths listed below cables



## Part Number/Price

PART #	CABLE LENGTH EACH	PRICE
100268	8 ft	\$325.00
101102	12 ft	335.00
104164	15 ft	338.00
100269	26 ft	375.00
100270	35 ft	385.00

## Load Cell Conduit Adapters

### Standard Features

- Used to adapt conduit to load cells
- 303 stainless steel

### Dimensions

PART #	A	B	PRICE
<b>Thread-On:</b>			
31533	3/8-24 UNF	—	\$30.00
31534	—	1/4-18 NPT	30.00
31535	5/8-18 UNF	1/2-14 NPT	30.00

Note: 31533 and 31534 are used together to form male-to-male adapter

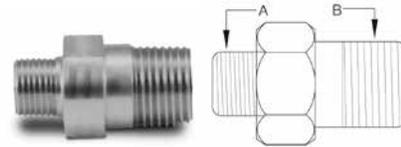

## Cord Grip Assemblies

### Standard Features

- Assemblies include cord grip, locknut, "O"-ring seal, gray and black reducer glands
- Fittings are made of weather- and corrosion-resistant nylon

### Part Number/Price

GLAND CABLE RANGES								
Part #	Thread	Panel Hole Diameter		Regular (Black)		Reducer (Gray)		Price
15669	PCN9	0.625 in	15.9 mm	.157-.314 in	4.0-8.0 mm	.118-.236 in	3.0-6.0 mm	\$4.50
15670	3/8 NPT	0.687 in	17.4 mm	.157-.314 in	4.0-8.0 mm	.118-.236 in	3.0-6.0 mm	4.25
15671	1/2 NPT	0.844 in	21.4 mm	.236-.472 in	6.0-12.0 mm	.200-.354 in	5.1-9.0 mm	4.85

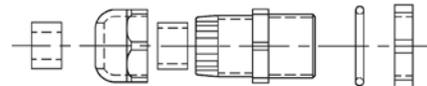

## EL214 Cable Splicing Kit

### Standard Features

- Designed for a complete, professional transducer cable splice
- PreVents moisture from entering the load cell through the cable connector

*Each kit contains a high-impact plastic splicing box, liquid-tight cable fittings, circuit card, PTFE sleeving, pre-measured potting compound and complete instructions*

### Specifications

**Dimensions:**

3.00 W x 1.00 H x 1.50 in D (76.2 W x 25.4 H x 38.1 mm D)

**Mounting Centers:**

2.50 in (63.5 mm)

**Number of Connections:**

7

**Cable Diameter:**

0.187 in-0.312 in (4.7 mm-7.9 mm)

**Cure Time For Potting:**

Epoxy-Polyamide resin cures in 2 hours at 73°F (23°C)



### Part Number/Price

PART #	DESCRIPTION	PRICE
15485	EL214	\$115.00

## EL214T Cable Splicing Kit

### Standard Features

- Designed to accommodate cables larger than the EL214; all other dimensions and performance features are the same

### Specifications

**Dimensions:**

3.00 W x 1.00 H x 1.50 in D (76.2 W x 25.4 H x 38.1 mm D)

**Mounting Centers:**

2.50 in (63.5 mm)

**Number of Connections:**

7

**Cable Diameter:**

0.270 in-0.480 in (6.9 mm-12.2 mm)

**Cure Time For Potting:**

Epoxy-Polyamide resin cures in 2 hours at 73°F (23°C)



### Part Number/Price

PART #	DESCRIPTION	PRICE
15486	EL214T	\$125.00

## EL215 Cable Splicing Kit

### Standard Features

- Designed for use in weather-exposed or direct-burial locations
- Each kit contains plastic splicing tube, circuit board, insulating resin and instructions

### Specifications

**Dimensions:**

1.375 in dia x 6.0 in long (34.9 mm dia x 152.4 mm long)

**Number of Connections:**

7

**Cable Diameter:**

up to .75 in (19.1 mm)

**Cure Time For Potting:**

2 hours at 70°F (21°C)



### Part Number/Price

PART #	DESCRIPTION	PRICE
15612	EL215	\$65.00

# Flintec™ Load Cell Cable Replacement Kits

## Standard Features

- Each kit includes cable for four Flintec SB4 or UB1 load cells as listed

## Part Number/Price

PART #	DESCRIPTION	CABLE LENGTH EA. FEET (M)		PRICE
18412	For SB4, 225-5200 lb (102.1-2358.7 kg)	10 ft	3.1 m	\$325.00
18413	For SB4, 11250-22,500 lb	15 ft	4.6 m	355.00



### 5-POSITION CONNECTORS, SHELL PLUGS, RECEPTACLES

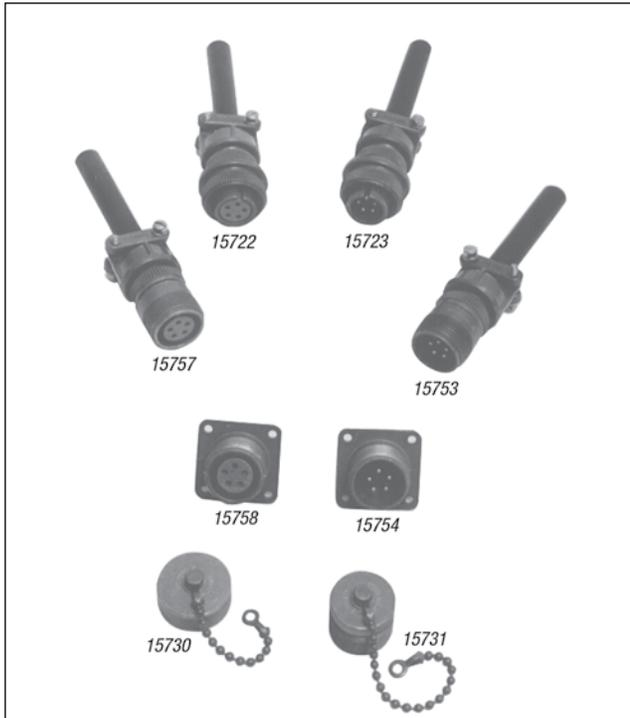

### 6-POSITION CONNECTORS, SHELL PLUGS, RECEPTACLES

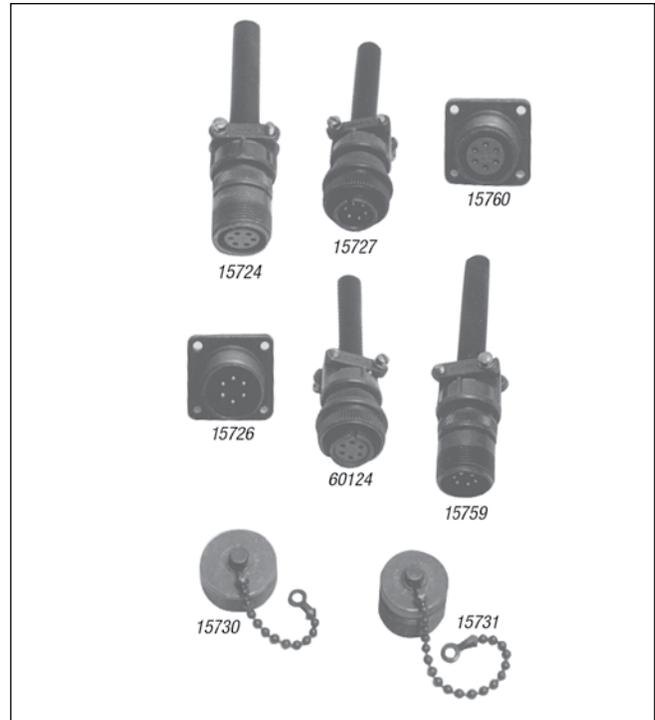

### 7-POSITION CONNECTORS, SHELL PLUGS, RECEPTACLES

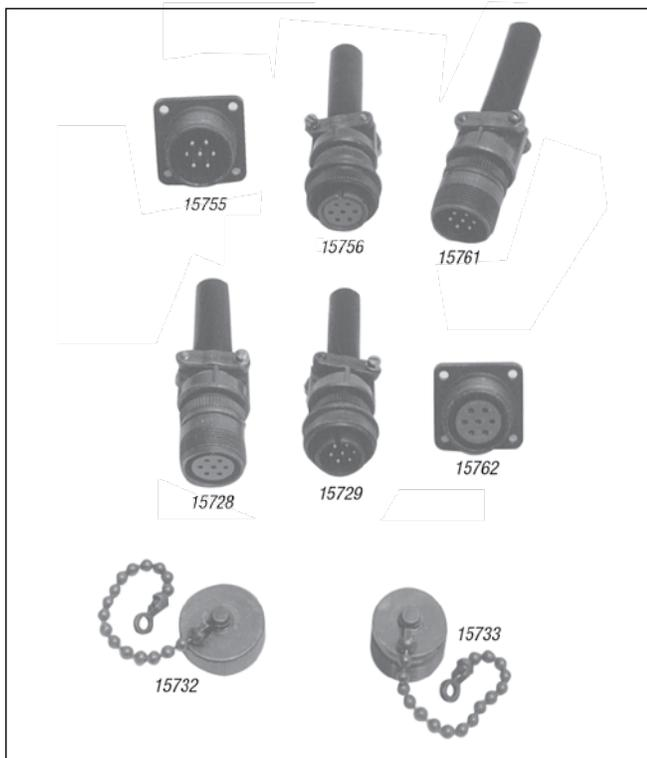

#### Part Number/Price

PART #	DESCRIPTION	PRICE
15753	5-Pin, external thread	\$28.00
15722	5-socket, internal thread	29.00
15723	5-Pin, internal thread	28.00
15757	5-socket, external thread	34.00
15754	5-Pin chassis mount, external thread	20.00
15758	5-socket chassis mount, external thread	20.00
15730	Dust cap for ext. thread 5-position connector	11.00
15731	Dust cap for int. thread 5-position connector	15.00
15759	6-Pin, external thread, male	28.00
60124	6-socket, internal thread connector, female fits Toledo load cells, Condec indicators	24.00
15727	6-Pin, internal thread, male	27.00
15724	6-socket, external thread	31.00
15726	6-Pin chassis mount, external thread	20.00
15760	6-socket chassis mount, external thread	19.00
15730	Dust cap for ext. thread 6-position connector	11.00
15731	Dust cap for int. thread 6-position connector	15.00
15761	7-Pin, external thread	29.00
15756	7-socket, internal thread	31.00
15729	7-Pin, internal thread	31.00
15728	7-socket, external thread	31.00
15755	7-Pin chassis mount, external thread	20.00
15762	7-socket chassis mount, external thread	23.00
15732	Dust cap for ext. thread 7-position connector	16.00
15733	Dust cap for int. thread 7-position connector	20.00



# T-Grip Molding

## Standard Features

- Designed for use in truck scale applications to PreVent spill-over into the pit
- Impact, tear, and weather-resistant EPDM rubber
- Barbed web to hold molding in place
- Web thickness .22 in (5.6 mm)
- Available by the foot or in 10.0 ft (3.1 m), 11.0 ft (3.4 m), 70.0 ft (21.34 m), 80.0 ft (24.4 m) and 100.0 ft (30.5 m) lengths. Maximum continuous length is 450 ft (137 m)



## Part Number/Price

PART #	H	W	W1	LENGTH	PRICE			
18799	2.56 in	65.0 mm	5.75 in	146.1 mm	0.22 in	5.6 mm	Sold by the foot	\$7.25/ft
18800	2.56 in	65.0 mm	5.75 in	146.1 mm	0.22 in	5.6 mm	10 ft 3.05 m	72.50
18801	2.56 in	65.0 mm	5.75 in	146.1 mm	0.22 in	5.6 mm	11 ft 3.35 m	79.75
18802	2.56 in	65.0 mm	5.75 in	146.1 mm	0.22 in	5.6 mm	70 ft 21.34 m	475.00
33219	2.56 in	65.0 mm	5.75 in	146.1 mm	0.22 in	5.6 mm	80 ft 24.4 m	515.00
33222	2.56 in	65.0 mm	5.75 in	146.1 mm	0.22 in	5.6 mm	100 ft 30.5 m	650.00

\*Maximum continuous length is 450 ft Call for price and availability

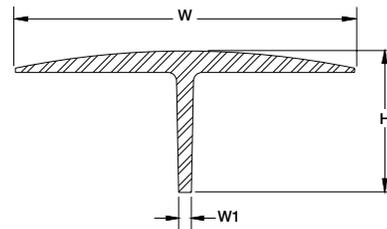

# T-Strip Molding

## Standard Features

- Designed for use in truck scale applications to PreVent spill-over into the pit
- Impact, tear, and weather-resistant SBR rubber
- Web thickness .25 in (6.4 mm)
- Available by the foot or in 10.0 ft (3.1 m), 11.0 ft (3.4 m), 70.0 ft (21.34 m), 80.0 ft (24.4 m) and 100.0 ft (30.5 m) lengths. Maximum continuous length is 450 ft (137 m)



## Part Number/Price

PART #	H	W	W1	LENGTH	PRICE			
18736	2.00 in	50.8 mm	4.50 in	114.3 mm	0.25 in	6.4 mm	Sold by the foot	\$6.75/ft
18776	2.00 in	50.8 mm	4.50 in	114.3 mm	0.25 in	6.4 mm	10 ft/3.05 m	67.50
18797	2.00 in	50.8 mm	4.50 in	114.3 mm	0.25 in	6.4 mm	11 ft/3.35 m	74.25
18798	2.00 in	50.8 mm	4.50 in	114.3 mm	0.25 in	6.4 mm	70 ft/21.34 m	435.00
33223	2.00 in	50.8 mm	4.50 in	114.3 mm	0.25 in	6.4 mm	80 ft/24.4 m	485.00
33224	2.00 in	50.8 mm	4.50 in	114.3 mm	0.25 in	6.4 mm	100 ft/30.5 m	585.00

\*Maximum continuous length is 450 ft Call for price and availability

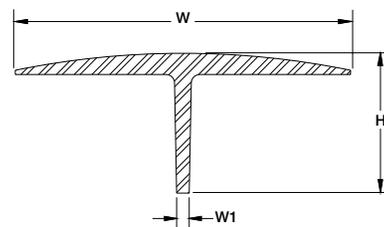

# Electronic Scale Tickets

## Hecon® Printers, EL522 & EL516 - 20266

### Standard Features

- Carbon triplicate interleaved
- Size: 4.25 in W x 7.875 in L (127 x 200 mm)
- Order quantity: 500 per package

20266

## SP2200, SP2000, RL250 & EL500 - 20265

### Standard Features

- Carbon triplicate interleaved, perforated and glued on one end
- Size: 5.5 in W x 9 in L (139.7 x 228.6 mm)
- Order quantity: 500 per package

20265

## Rice Lake Scales - 71630 or 105182

### Standard Features

- Carbonless duplicate or triplicate
- Size: 4.25 in x 7 in (107 mm x 177.8 mm) attached at 4.25 side
- Order quantity: 500 per package
- Custom (Duplicate):
  - Add company name (min. order 5 packs - \$48.00 ea)
  - Custom (Triplicate):
    - Add company name (min. order 5 packs - \$68.00 ea)

## Blank Scale Ticket - 22263

### Standard Features

- 3-part carbonless
- White, canary yellow, and pink
- Size: 4.25 in W x 5.5 in L (108 mm x 140 mm)
- Attached at 4.25 edge
- Custom - Add company name (min. order of 2500 - \$0.20 ea)



## Part Number/Price

PART #	DESCRIPTION	PRICE
20266	Hecon Printers, EL522 & EL516, 500/pack	\$92.00
20265	SP2200, SP2000, EL250 & EL500, 500/pack	95.00
71630	Rice Lake ticket, 2 part, 500/pack	50.00
105182	Rice Lake ticket, 3 part, 500/pack white, canary yellow, pink	72.00
22263	Blank scale ticket, each	0.22 each

# Mechanical Scale Tickets

## Fairbanks™ Scales - 20260

### Standard Features

- Carbon triplicate with 2 in (50.8 mm) tear-off flap
- Size: 1.875 in W x 4.75 in L (47.6 x 120.7 mm)
- Order quantity: 500 per package

WEIGHED ON A FAIRBANKS SCALE				No. _____
Load _____			Date _____	Received by _____
From _____				
Gross _____	lbs.	To _____		
Tare _____	lbs.	Address _____		
Net _____	lbs.	Price _____	Amt. _____	
_____ On _____	Off	Weigher _____		
Form 333A				Printed in U.S.A.

## Howe™ Scales - 20261

### Standard Features

- Carbon triplicate with 2 in (50.8 mm) tear-off flap
- Size: 1.75 in W x 5.5 in L (44.5 x 139.7 mm)
- Order quantity: 500 per package

Weight obtained by using THE HOWE PATENTED RECORDING BEAM				No. _____
From _____			To _____	Received by _____
Gross _____	Load of _____			
Tare _____	Driver { On _____			
Fees _____	Off _____	Date _____	20 _____	
Net _____			Weigher _____	
Form 3A				

# Create Your Own Custom Ticket

### Standard Features

- Send us a copy of the existing custom format or drawing of a completely new one. Please specify number of carbon copies, dimensions, colors and text. Minimum order quantity may apply.



### Part Number/Price

PART #	DESCRIPTION	PRICE
20260	Fairbanks Scales, 500/pack	\$65.00
20261	Howe Scales, 500/pack	65.00

## Scale Veils

Protect your electronic scales, weight indicators and printers with a scale veil. Reduce costly repairs and down time due to moisture penetrating through instrument enclosures during cleanup or operation.

### Standard Features

- Tough, flexible transparent vinyl, constructed with heavy-duty stitching
- Loose fit allows for operation of switches or controls through the scale veil
- Available for most types of scale equipment



### Part Number/Price

PART #	MODEL	PRICE
<b>RICE LAKE</b>		
21210	SP2000/SP2200	\$75.00
<b>EPSON</b>		
29582	TM290/295	55.00
35666	TM-U200 TM-U220	60.00
111840	TM-U590	65.00
<b>OKIDATA</b>		
21208	Okidata 184 Turbo Printer	65.00
21226	Okidata 320/390	65.00

*Custom veils and specials available; consult factory.*

# Cables



## Part Number/Price

PART #	DESCRIPTION	PRICE
<b>Interface Cables for SP-2200, TM-U295, TM-U590 and Star® Printers</b>		
15547	Blunt end, 25-Pin D-sub male RS-232 serial interface cable	\$65.00
15548	25-Pin D-sub male to 25-Pin D-sub male 20 mA serial interface cable (SP2200 only)	65.00
15568	25-Pin D-sub male to 25-Pin D-sub male RS-232 serial interface cable	65.00
Consult	Custom 20 mA/RS-232 serial interface cable	110.00
<b>Interface Cables for I-Class</b>		
15547	Blunt end, 25-Pin D-sub male RS-232 serial interface cable	65.00
Consult	Custom RS-232 interface cable	110.00
<b>Interface Cables for Eltron Desktops, E-4203 and M-4206</b>		
41276	DB9 male RS-232 cable to blunt end	65.00
<b>Straight Cable</b>		
50749	DB9 female to DB9 female	55.00
41279	DB25 male to DB9 male	65.00
70056	DB9M to DB9F	35.00
<b>Null Modem Cable</b>		
66535	DB9F to DB9 female, Null modem	45.00
64794	DB9F to DB9M, Null modem, 6ft	65.00
<b>USB Cable</b>		
79074	USB-A to USB-B	30.00
153603	USB to 9-Pin Male RS-232 adapter	85.00
156806	USB 2.0 A to A, 1 m	30.00
156807	USB 2.0 A to A, 3 m	45.00
156808	USB 2.0 A to A, 5 m	55.00
156809	USB 2.0 to USB-B male type A	45.00
156815	USB 2.0 to USB-B male type A to male type B micro, 3 m	50.00
156811	USB 2.0 to USB-B male type A to male type B micro, 5 m	65.00
156817	EtherNet TCP/IP CAT.5E RJ45 1 m	30.00
156818	EtherNet TCP/IP CAT.5E RJ45 3 m	37.00
156821	EtherNet TCP/IP CAT.5E RJ45 5 m	45.00
<b>Ethernet Cable/RJ45</b>		
72697	RJ45 to RJ45, 7 ft	35.00
78860	RJ45 to RJ45, cross over 7 ft	35.00
75594	RJ45 to 9-Pin female	65.00

Blunt-end cables interface to: UMC444, UMC555, UMC600, IQ700, IQ plus® 310A, IQ plus® 355, IQ plus® 390-DC, IQ plus® 510, IQ plus® 590-DC, IQ plus® 710, IQ plus® 800, and IQ plus® 810, 520 and 920i

Custom cables are designed to interface with your specific equipment. Please specify equipment model number and connector type. Standard cable length is 5 ft (1.5 m).



156809 (1 m)  
156811 (3 m)  
156815 (5 m)



156817 (1 m)  
156818 (3 m)  
156821 (5 m)



156806 (1 m)  
156807 (3 m)  
156808 (5 m)

## Static Brushes

PART #	STATICMASTER PART #	DESCRIPTION	PRICE
76669	1C200	Static Brush 1 in	\$131.00
76670	1C200R	Replacement cartridge	85.00



## Static Brushes

PART #	STATICMASTER PART #	DESCRIPTION	PRICE
76671	3C500	Static Brush 3 in	\$199.00
76672	3C500R	Replacement cartridge	134.00



## Ionizing Strips

PART #	STATICMASTER PART #	DESCRIPTION	PRICE
76677	1U400	Ionizing unit 1 in x 1 in	\$134.00
76678	1U200	Ionizing unit 1 in x 1 in	85.00



## Ionizing Strips

PART #	STATICMASTER PART #	DESCRIPTION	PRICE
76676	2U500	Ionizing unit 1 in x 3 in	\$134.00

## Ionizing Strips Accessories

PART #	STATICMASTER PART #	DESCRIPTION	PRICE
76679	BF1	Ionizer Positioner	\$69.00
76680	BF2	Ionizer Positioner Only - C Bracket	98.00



## Desiccants

### Standard Features

- Packets
- Bagged desiccants to protect your enclosed electronic components from moisture and humidity
- Useful in junction boxes, indicators and all scale electronics

### Part Number/Price

PART #	DESCRIPTION	PRICE
16038	Mini Pax® 7 g	\$1.10
16039	NatraSorb® 20 g	2.00
92240	3 g	1.10



## Industrial Corrosion Inhibitor

### Standard Features

- Our Best Indicator Protection
- Special chemical combination provides superior protection
- Protects 5 cubic feet/1.4 cubic meters of enclosure volume for approximately one year
- Dimensions: 2.5 in dia. x 1.5 in H (63.5 mm dia. x 38.1 mm H)

### Part Number/Price

PART #	DESCRIPTION	PRICE
16037	Corrosion Inhibitor	\$28.00



## Crimper and Lead Seals

### Standard Features

#### Crimper

- 5.0 in (127.0 mm) seal press with two .5 in (12.7 mm) engraving dies
- Chrome finish
- Compound leverage
- Quick delivery on custom dies

#### Lead Seals

- 25 in (6.4 mm) heavy duty seal with galvanized steel wire. Length-16.0 in (406.4 mm)

### Part Number/Price

PART #	DESCRIPTION	PRICE
21111	Crimper and 2 Die Blanks	\$130.00
15318	Crimper Die Blank (replacements)	55.00
15317	100 Seals/pkg	45.00

Maximum number of characters that can be engraved on die is 9



## Static Control Table Mat and Floor Mat

An absolute must for every workbench, this kit includes a 3-layer 2 ft x 4 ft table mat, 4 ft x 6 ft floor mat, ground cord and adjustable wrist strap. Designed specifically for energized circuit work, the static control table and floor mat provide superior protection against ESD.



### Part Number/Price

PART #	DESCRIPTION	PRICE
34265	Static Control Table Mat & Floor Mat	\$825.00

## Static Control Wrist Strap

The single most important personal accessory for protecting ESD-sensitive components and circuits, this wrist strap protects against charges from the body. The wrist strap consists of a comfortable elastic cuff or band and a detachable conductive cord for grounding the wrist band.



### Part Number/Price

PART #	DESCRIPTION	PRICE
34263	Static Control Wrist Strap	\$50.00

## Static Shielding Bags

This static shield bag offers total ESD protection, whether you're transporting ESD-susceptible products across the room or across the country. The outer layer of the bag consists of an abrasion-resistant polyester, while the antistatic polyethylene inner layer retards triboelectric static charging from inside the bag.



### Part Number/Price

PART #	DESCRIPTION	PRICE
16150	Static Shielding Bags, 8 in x 10 in	\$1.10 each
16151	Static Shielding Bags, 12 in x 18 in	3.25 each



# Static-Safe Service Kit

## Standard Features

- Eliminates static for safe board replacement
- Connects a field service technician and the static-safe work surface to the same ground point
- Harmlessly drains static charges from the body and from any conductive objects placed on the mat
- Folds into a compact unit for transport and storage

## Part Number/Price

PART #	DESCRIPTION	PRICE
32818	Static-Safe Service Kit	\$185.00



# Portable Megometer

## Standard Features

- Load cell insulation tester
- Easy to use, accurate and reliable
- Designed for strain gauge transducer testing

## Part Number/Price

PART #	DESCRIPTION	PRICE
36253	Portable Megometer	\$695.00





# Indicators/Controllers

## Table of Contents

<b>120/120 Plus</b> .....	<b>360</b>	<b>SCT-10</b> .....	<b>400</b>
Digital Weight Indicator		Signal Conditioning Transmitter/Indicator	
<b>IQ plus® 210</b> .....	<b>362</b>	<b>SCT-20</b> .....	<b>401</b>
Digital Weight Indicator		Signal Conditioning Transmitter/Indicator	
<b>IQ plus® 390-DC</b> .....	<b>363</b>	<b>SCT-30</b> .....	<b>402</b>
Battery Powered Digital Weight Indicator		Signal Conditioning Transmitter/Indicator	
<b>SURVIVOR® 390HE</b> .....	<b>364</b>	<b>Relays and Racks</b> .....	<b>403</b>
Hostile Environment Digital Weight Indicators		Input/Output Components	
<b>420 Plus</b> .....	<b>365</b>	Grayhill Relays and Racks	
HMI Digital Weight Indicator		<b>Input and Output Components/ Grayhill and OPTO 22 Relays and Racks</b> .....	<b>404</b>
<b>SURVIVOR® 420HE</b> .....	<b>367</b>	<b>Explosive Environment Equipment Policy</b> .....	<b>405</b>
Hostile Environment Digital Weight Indicators		<b>Hazardous Area Classification</b> .....	<b>406</b>
<b>480/480 Plus Legend™ Series</b> .....	<b>368</b>	<b>Explosive Environment Solutions</b> .....	<b>407</b>
Digital Weight Indicator		<b>Hazardous Atmospheres</b> .....	<b>408</b>
<b>482/482 Plus Legend™ Series</b> .....	<b>370</b>	<b>320IS</b> .....	<b>409</b>
Digital Weight Indicator		Intrinsically Safe Digital Weight Indicator	
<b>IQ plus® 590-DC</b> .....	<b>372</b>	<b>320IS Plus</b> .....	<b>411</b>
Battery Powered Digital Weight Indicator		Intrinsically Safe Digital Weight Indicator	
<b>720i™</b> .....	<b>374</b>	<b>EL232 XPCD</b> .....	<b>413</b>
Programmable HMI Indicator/Controller		Explosion Proof Remote Serial Display	
<b>820i®</b> .....	<b>376</b>	<b>Intrinsic Safety Barriers</b> .....	<b>414</b>
Programmable HMI Indicator/Controller		<b>Profibus® DP Interface</b> .....	<b>416</b>
<b>880/880 Plus Performance™ Series</b> .....	<b>378</b>	720i/820i/920i	
Digital Weight Indicator/Controller		<b>Profibus® DP Interface</b> .....	<b>417</b>
<b>920i®</b> .....	<b>380</b>	880	
Programmable HMI Indicator/Controller		<b>ProfiNet® Interface</b> .....	<b>418</b>
<b>920i® USB</b> .....	<b>384</b>	880	
Programmable HMI Indicator/Controller		<b>Allen-Bradley® Remote I/O</b> .....	<b>419</b>
<b>920i® User Programs</b> .....	<b>386</b>	720i®/820i®/920i®	
<b>920i® FlexWeigh Systems</b> .....	<b>387</b>	<b>DeviceNet™ Interface</b> .....	<b>420</b>
Fillers/Batchers		720i®/820i®/920i®	
<b>920i® FlexWeigh Systems</b> .....	<b>389</b>	<b>DeviceNet™ Interface</b> .....	<b>421</b>
Bulkweighers		880	
<b>920i® FlexWeigh Systems</b> .....	<b>391</b>	<b>ControlNet™ Interface</b> .....	<b>422</b>
Flow Rate Controllers		820i®/920i®	
<b>920i® FlexWeigh Systems</b> .....	<b>393</b>	<b>MODBUS-TCP® Interface</b> .....	<b>423</b>
Hand Batching		880	
<b>MSI-8000HD</b> .....	<b>394</b>	<b>EtherNet/IP® Protocol Card for AB PLC</b> .....	<b>424</b>
Digital Weight Indicator		720i®/820i®/920i®	
<b>CW-90</b> .....	<b>395</b>	<b>EtherNet/IP® for AB PLC</b> .....	<b>425</b>
Checkweigher Indicator Only		880	
<b>CW-90X</b> .....	<b>397</b>	<b>Ethernet TCP/IP Interface</b> .....	<b>426</b>
Checkweigher Indicator Only		720i®/820i®/920i®	
<b>VIRTUi2®</b> .....	<b>399</b>	<b>TranSend®</b> .....	<b>427</b>
PC-Based HMI for iQUBE2®		Wireless Load Cell Interface System	

**ESPAÑOL** | Visit [ricelake.com/spanish](http://ricelake.com/spanish) to see all RLWS materials available in Spanish

Product names, logos, brands, and other trademarks featured or referred to within this publication are the property of their respective trademark holders.

# Indicators/Controllers

## Table of Contents

<b>SendIt® Wireless Load Cell Interface System</b> .....	<b>429</b>
<b>ConnexLink™</b> .....	<b>430</b>
Wireless Radio 900 MHZ Transceivers	
<b>Industrial Broadband Wireless Ethernet</b> .....	<b>431</b>
<b>XTend-PKG™ RF Modems</b> .....	<b>432</b>
<b>QWERTY Style Keyboards and Aluminum Keypads</b> .....	<b>433</b>
<b>X-Purge</b> .....	<b>434</b>
<b>Tripp-Lite USB to Serial Converters</b> .....	<b>435</b>
Serial Adapters	
<b>437 Bridgesensor</b> .....	<b>436</b>
Signal Conditioner	
<b>463 Bridgesensor</b> .....	<b>437</b>
Signal Conditioner	
<b>API 4058G - 441/442 Bridgesensors</b> .....	<b>438</b>
Load Cell Signal Conditioners	
<b>Amphenol® RJF 544</b> .....	<b>440</b>
Harsh Environment Ethernet Connection System	
<b>AbleCable®</b> .....	<b>441</b>
RS 232/USB Serial Smart Cable Direct, Keyboard Input Direct	
<b>go-between</b> .....	<b>442</b>
Data Capture and Storage	



# 120/120 Plus

## Digital Weight Indicator

### Specifications

#### Power:

##### 120/120 Plus:

Line voltages: 115 or 230VAC

Frequency: 50 or 60 Hz

##### 120 Plus: (estimated battery life)

60 hours with 1 x 350Ω

40 hours with 4 x 350Ω

Charge time 8 hours

#### Excitation Voltage:

5VDC, 4 x 350Ω or 8 x 700Ω load cells

#### Analog Signal Input Range:

-0.6 mV/V - 3.0 mV/V

#### Analog Signal Sensitivity:

0.3 μV/graduation minimum,

1.5 μV/grad recommended

#### Resolution:

Internal resolution: 1 million internal graduations

Display resolution: 10,000 displayed graduations

#### Measurement Rate:

120: 30, 15, 7, 3 per second

120 Plus: 30 per second

#### System Linearity:

Within 0.01% of full scale

#### Circuit Protection:

RFI, EMI, ESD protected

#### Load Cell Connection:

Cord grip entry

Detachable plug (optional)

#### Serial Output:

EDP port: Full duplex RS-232

Printer port: Output-only RS-232 or active 20 mA current loop

Both ports: 9600, 4800, 2400, 1200, 600, 300 bps; 7 or 8 data bits; even, odd or no parity

#### Display:

##### 120:

0.8 in (20 mm), 6-digit Red Light Emitting Diode (LED) display, 7-segment digits

##### 120 Plus:

0.8 in (20 mm) 6-digit LCD with backlight, 7-segment digits

#### Status Annunciators:

Designators for: center of zero, stand still, gross, net, lb, kg, oz, g

##### 120 Plus:

Battery, setpoint 1 & 2, Hold

#### Keyboard:

##### 120:

5-key flat membrane panel, tactile feel

##### 120 Plus:

Zero, tare, present tare, hold, gross/net, units, numeric 0-9, clear, enter/print

#### Digital I/O:

120 Plus: Requires option card

24 volt source

3 digital inputs

2 digital outputs

#### Operating Temperature:

Legal: 14°F to 104°F (-10°C to 40°C)

Industrial: 14°F to 122°F (-10°C to 50°C)

#### Weight:

2.6 lb (1.2 kg)

#### Rating/Material:

Enclosure: heavy gauge ABS

#### Warranty:

One-year limited warranty

#### Approvals:

NTEP CC 03-059, Class III/III 10,000d

Measurement Canada AM-5517, Class III/IIIHD 10,000d

OIML TC 7028, TC7628; T 5692 10,000 Divisions

CE marked



120



120 Plus

### APPROVALS



Measurement  
Canada  
Approved



### Standard Features

#### 120

- Large .8 in (20.3 mm) Light Emitting Diode (LED) Display
- Configurable analog to digital measurement rate
- Power for four 350 Ohms load cells
- Primary/secondary units configuration: lb, kg, ounces, grams
- Five-button operation
- Two independent communication ports: (1) full duplex, (1) unidirectional or active 20 mA current loop
- Standardized EDP command sets
- Programmable ticket format up to two 180-character printout
- Full front-panel digital calibration and configuration
- Tilt stand
- Three-stage digital filtering
- Consecutive transaction numbering
- Time and date (volatile)

#### 120 Plus

- Large .8 in backlit LCD display
- Rechargeable battery and wall adapter
- Power save feature for 700 hours of battery life
- Ten stored tare values
- Display hold (based on 3 second average)
- Time and date
- Configurable with Revolution software

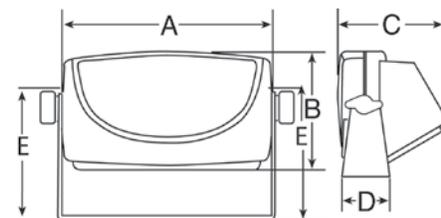

#### DIMENSIONS

A	7.32 in (183 mm)	D	1.65 in (42 mm)
B	6.06 in (154 mm)	E	4.76 in (121 mm)
C	3.74 in (95 mm)		

# 120/120 Plus

## Digital Weight Indicator

### Part Number/Price

PART #	DESCRIPTION	EST. SHIP WEIGHT	PRICE
<b>120</b>			
131923**	Desktop 115VAC/230VAC	3 lb	\$325.00
<b>120 Plus</b>			
103632**	Desktop 115/230 VAC	3 lb	450.00
107619**	Desktop 115/230 VAC with digital I/O option	3 lb	510.00

### Options/Accessories

PART #	DESCRIPTION	PRICE
93205	Load cell connector with 6 meter length pigtail (requires 103507)	\$45.00
82505	6-Pin socket external load cell connector (requires 103507)	10.50
103507	External load cell plug replaces cord grip (requires 82505 or cable 93205)	31.00
107620	Digital I/O card for 120 Plus	65.00
105670	15-Pin connector for 120 Plus	10.50
106705	15-Pin Interface cable for 120 Plus, 2-meter length	31.00
76699	Additional operating manual for 120	30.00
105914	Additional operating manual for 120 Plus	25.00
77925*	Revolution® Scale software	35.00
<b>Primary Component Parts for 120</b>		
131924	Board assembly for use with internal LC connector	245.00
78610	Overlay membrane switch	50.00
131925**	Power supply, 115VAC/230VAC	36.00
<b>Primary Component Parts for 120 Plus</b>		
103634	CPU/Display board assembly	349.00
103635	Overlay membrane switch	50.00
103636	Power supply, 115VAC/230VAC	36.00
103637	Rechargeable Battery	78.00

\*Revolution can be downloaded for FREE at [www.ricelake.com](http://www.ricelake.com)



CEE 7/7 plug



NEMA 5-15 plug

\*\*Both plugs included with power adapter

# IQ plus® 210

Digital Weight Indicator

## Specifications

**Display:**

6-digit Light Emitting Diode (LED) display  
7-segment, 0.8 in (20 mm) digits

**Excitation:**

10VDC 4 x 350Ω load cells

**Measurement Rate:**

15, per second

**Display Resolution:**

10,000 dd maximum

**Power Consumption:**

115VAC at 70 mA,  
or 230VAC at 35 mA, 50-60 Hz

**Digital Inputs:**

Two inputs, TTL or switch closure, active-low

**Serial Communications:**

Full duplex RS-232, 9600, 4800, 2400, 1200 bps; 7 or 8 databits, even, off, or no parity

**Operating Temperature:**

14°F to 104°F (-10°C to 40°C)

**Storage Temperature:**

14°F to 122°F (-10°C to 50°C)

**Enclosure Dimensions:**

9.5 x 6.0 x 2.75 in  
(241 x 152 x 70 mm)

**Weight:**

10 lb (4.5 kg)

**Rating Material:**

NEMA 4X/IP66, stainless steel

**Warranty:**

Two-year limited warranty

**Approvals:**

NTEP CC 00-045, Class III/III 10,000d



## APPROVALS



## Standard Features

- Piezo switch technology with stainless steel buttons (zero and units)
- Large, bold 0.8 in LED display
- NEMA 4X stainless steel enclosure
- Status annunciators: lb, kg, oz, g, negative, motion, center of zero
- Displays units in decimals lb, kg, oz, lb & oz and grams
- One full duplex RS-232 port
- Two digital inputs for remote zero, print and units
- PreVent™ breather vent
- Configurable with Revolution software

## IQ plus 210

PART #	DESCRIPTION	EST. SHIP WEIGHT	PRICE
65137	IQ plus 210, 115VAC	10 lb	\$565.00
65138	IQ plus 210, 230VAC	10 lb	565.00

## Options/Accessories

PART #	DESCRIPTION	PRICE
64640	Additional operating manual	\$31.00

If ordering the two non-tactile buttons or column without a scale, refer to the replacement parts catalog for part number and pricing

DIMENSIONS			
A	9.50 in (241 mm)	E	6.00 in (152 mm)
B	10.03 in (254 mm)	F	8.58 in (217 mm)
C	11.67 in (296 mm)	G	3.75 in (95 mm)
D	2.69 in (68 mm)		

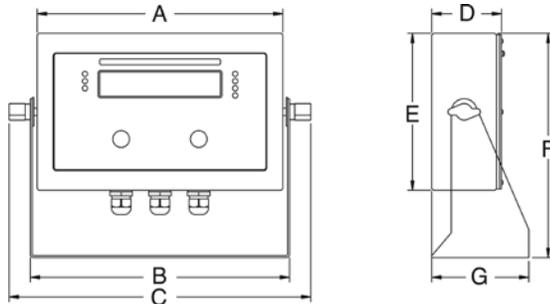



# IQ plus® 390-DC

Battery Powered Digital Weight Indicator

## Specifications

### Power:

9VDC, provided by 6 "C" cell alkaline batteries or AC adapter  
 Power consumption: (Estimated battery life)  
 100 mA (100 hours with 4 x 350Ω load cells),  
 25 mA typical (300 hours with 1 load cell)

### Excitation Voltage:

5VDC, 4 x 350Ω or 8 x 700Ω load cells

### Analog Signal Input Range:

-2.5 mV – 22.5 mV or -5 mV/V – 4.5 mV/V

### Analog Signal Sensitivity:

0.3 μV/graduation minimum  
 1.5 μV/grad recommended

### Resolution:

Internal resolution: 1 million counts  
 Display resolution: 100,000dd  
 Counting capacity: 100,000

### Measurement Rate:

30, 15, 7 1/2, 3 3/4 per second

### System Linearity:

Within 0.01% of full scale

### Serial Communications:

EDP/Printer port: Full duplex RS-232

### Display:

1.0 in (24.5 mm) 6-digit Liquid Crystal Display (LCD), 7 segment, digits

### Circuit Protection:

RFI, EMI, ESD protection

### Status Annunciators:

Designators for: center of zero, standstill, gross, net, lb, kg, piece count

### Keyboard:

6-key flat membrane panel, tactile feel

### Operating Temperature:

Legal: 14°F to 104°F (-10°C to 40°C)  
 Industrial: 14°F to 122°F (-10°C to 50°C)

### Weight:

3 lb (1.4 kg)

### Rating/Material:

NEMA 4X/IP66, stainless steel

### Warranty:

Two-year limited warranty

### Approvals:

NTEP CC 98-203, Class III/IIIL 10,000d  
 Measurement Canada AM-5300, Class IIII 10,000d and IIIHD 20,000d  
 CE marked  
 UL & CUL listed

## DIMENSIONS

A	11.04 in (280 mm)	E	1.62 in (41 mm)
B	9.0 in (228 mm)	F	3.24 in (82 mm)
C	5.52 in (140 mm)	G	4.09 in (104.9 mm)
D	6.42 in (163 mm)	H	3.0 in (76 mm)

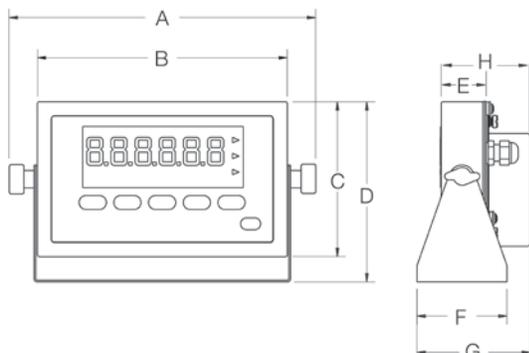

## APPROVALS



Measurement  
Canada  
Approved



## Standard Features

- NEMA 4X/IP66-rated stainless steel enclosure
- Large 1 in (24.5 mm), six-digit Liquid Crystal Display (LCD)
- Six button operation
- Power for four 350 Ohms load cells or eight 700 Ohms load cells
- Configurable units multiplier
- Supports 4- and 6-wire load cell connections
- EDP port for full duplex, RS-232 communications
- Powered by 6 "C" cell alkaline batteries for complete portability (batteries not included)
- AC adapter for 115 or 230VAC power
- Configurable standby mode that saves battery life
- RATTLETRAP® three-stage digital filtering
- Piece count mode
- Configurable with Revolution software

## Part Number/Price

PART #	DESCRIPTION	WEIGHT	PRICE
48815 †	IQ plus 390-DC battery powered with 115VAC wall adapter	6 lb	\$750.00
50064 ††	IQ plus 390-DC battery powered with 230VAC wall adapter	6 lb	750.00
66727	IQ plus 390-DC CE marked (voltage adapter sold separately)	6 lb	725.00
53629 †	IQ plus 390-DC with 115 VAC wall adapter with quick connect	6 lb	800.00
53634 ††	IQ plus 390-DC with 230 VAC wall adapter with quick connect	6 lb	800.00

## Options/Accessories

PART #	DESCRIPTION	PRICE
65738	Livestock weighing option, AW 1.02 (not NTEP Certified)	\$95.00
77925*	Revolution® scale software	35.00
48820	Additional operating manual	25.00
92777	Filter, PreVent™ vent kit	25.00
91895	Quick Connect, female connector and cable, 17 in	21.00
53640	Quick Connect, male connector and cable, 20 ft	36.00

### Primary Component Parts

PART #	DESCRIPTION	PRICE
49978	Power supply, 115VAC	25.00
130185	Power supply, 230VAC (2-Pin Europe)	35.00
48790	Overlay membrane panel	55.00
49954	Board assembly	495.00

\* Revolution can be downloaded for FREE at [www.ricelake.com](http://www.ricelake.com)



†† CEE 7/7 plug



† NEMA 5-15 plug

# SURVIVOR® 390HE

Hostile Environment Digital Weight Indicators

## Specifications

### Excitation Voltage:

5VDC

Load current: 60 mA maximum (4 x 350 Ω load cells)

### Analog Signal Input Range:

0.5 mV/V - 3.5 mV/V

### Analog Signal Sensitivity:

0.3 microvolts/graduations minimum

### Measurement Rate:

30, 15, 7 1/2, 3 3/4 updates second

### System Linearity:

Within 0.01% of FS

### Resolution:

Internal resolution: 1 million counts

Display: selectable up to 100,000 dd

### Display:

1 in (25 mm) LCD Display,

Decimal point available at each digit

### Status Annunciators:

Tare, entered tare, standstill, net, gross, center of zero, minus sign, lb, kg

### Front-Panel:

5-button rubber-booted watertight switches

### Circuit Protection:

ESD, EMI, RFI protected

### Serial Output:

Printer port: RS-232 full duplex 7 or 8 data bits; even, odd or no parity

Baud rates: 300 to 19200

### Power:

Line voltages: 115 or 230VAC

Frequency: 50/60 Hz

Power consumption: 25W maximum

### Operating Temperature:

14°F to 104°F (-10°C to 40°C)

### Rating/Material:

NEMA 4X FRP

### Weight:

Approximately 17 lb (7.2 kg)

### Warranty:

Two-year limited warranty

### Approvals:

NTEP CC 98-203, Class III/IIIL 10,000d

Measurement Canada AM-5300 Class III/IIHD 10,000d



## APPROVALS



Measurement  
Canada  
Approved

## Standard Features

- NEMA 4X Fiberglass-Reinforced Polyester (FRP) enclosure
- Bold 1 in LCD
- Universal mounting tabs (replaceable)
- Up to 30 updates/second
- Selectable display update rate
- Five button operation, environmentally protected mechanical switches
- Selectable units
- One communication port, full duplex RS-232
- RATTLETRAP® vibration control
- Configurable with Revolution software

## Part Number/Price

PART #	DESCRIPTION	WEIGHT	PRICE
53517	SURVIVOR® 390HE 115VAC	17 lb	\$950.00

## Options/Accessories

PART #	DESCRIPTION	PRICE
30911	Additional mounting tabs (set of 4)	\$30.00
92777	Filter, PreVent™ vent kit	25.00

### Primary Component Parts

76205	Board assembly, CPU/display	495.00
100065	AC power supply	89.00

## DIMENSIONS

A	10.50 in (267 mm)	D	10.00 in (254 mm)
B	8.50 in (216 mm)	E	8.00 in (203 mm)
C	6.00 in (152 mm)		

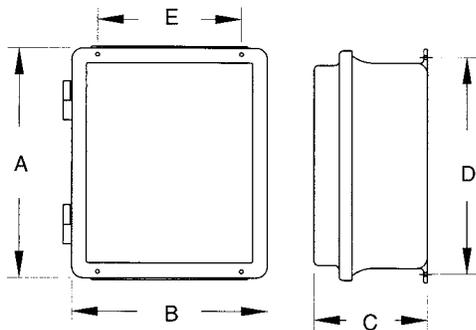

# 420 Plus

## HMI Digital Weight Indicator

### Specifications

#### Power - AC:

Line voltages: 115/230VAC  
 Frequency: 50 or 60 Hz  
 Power consumption: 1.5A at 115VAC (8W)  
 0.75A at 230VAC (8W)

#### Power - DC:

Line voltages: 9-36VDC DC input  
 Power consumption: 1.5A Max

#### Excitation Voltage:

+5VDC 8 x 350Ω or 16 x 700Ω load cells

#### Analog Signal Input Range:

-0.5 mV/V - 4.5 mV/V

#### Analog Signal Sensitivity:

0.3 μV/graduation minimum,  
 1.5 μV/grad recommended

#### Resolution:

Internal resolution: 8 million internal graduations  
 Display resolution: 100,000 displayed graduations

#### Measurement Rate:

60, 30, 15, 7 1/2, per second

#### System Linearity:

Within 0.01% of full scale

#### Digital Inputs:

2 inputs with 8 functions  
 2 outputs, 250 mA max sink

#### Circuit Protection:

RFI, EMI, ESD protection

#### Serial Output:

EDP port: Full duplex RS-232  
 Printer port: Full duplex RS-232 or simplex active 20 mA current loop  
 Both ports: 38400, 19200, 9600, 4800, 2400, 1200, 600, 300 bps; 7 or 8 data bits; even, odd, or no parity

#### Display:

0.8 in (20 mm), 6-digit Super Red Light Emitting Diode (LED) display, 7-segment, digits

#### Status Annunciators:

Designators for: center of zero, stand still, gross, net, lb, kg, count, tare

#### Keyboard:

21-key flat membrane panel

#### Operating Temperature:

Legal: 14°F to 104°F (-10°C to 40°C)  
 Industrial: 14°F to 122°F (-10°C to 50°C)

#### Weight:

6.1 lb (2.8 kg)

#### Rating/Material:

Enclosure: NEMA 4X/IP66, heavy gauge stainless steel

#### Warranty:

Two-year limited warranty

#### Approvals:

NTEP CC 04-076, Class III/IIIL 10,000d  
 Measurement Canada AM-5554, Class III/IIHD 10,000d  
 OIML TC7004, 10,000d,  
 UL & CUL listed  
 CE marked



### APPROVALS



### Standard Features

- Large .8 in (20.3 mm) LED Display
- Full numeric keypad
- NEMA 4X/IP66 stainless steel washdown enclosure
- Power for eight 350 ohms load cells or 16, 700 ohms load cells
- Configurable analog to digital measurement rate
- Primary/secondary units configuration: lb, kg, ounces, short tons, metric tons, grams or none
- Two independent communication ports:  
 (2) full duplex, (1) unidirectional active 20 mA current loop
- Standardized EDP command sets
- Programmable ticket formats up to three 300-character printouts
- Full front-panel digital calibration and configuration
- Universal mounting stand
- Three-stage digital filtering
- Consecutive transaction numbering
- Two digital inputs, two digital outputs
- Time and date
- Count mode
- Two setpoints
- Keyed tare
- Accumulator
- Configurable with Revolution software

### DIMENSIONS

A	9.50 in (24 mm)	F	8.57 in (217 mm)
B	10.02 in (254 mm)	G	6.00 in (152 mm)
C	11.80 in (299 mm)	H	3.25 in (82 mm)
E	3.12 in (79 mm)		

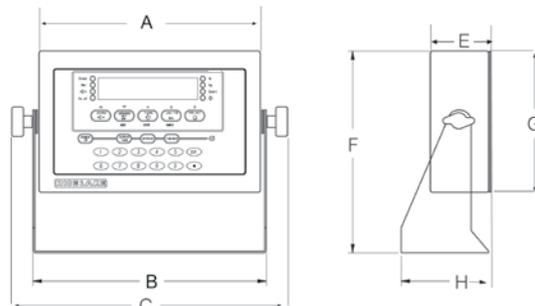

# 420 Plus

HMI Digital Weight Indicator

## Part Number/Price

PART #	DESCRIPTION	WEIGHT	PRICE
85124 †	420, 115VAC	10 lb	\$775.00
85125 †	420, 230VAC	10 lb	775.00
85126 ††	420, 230VAC CE marked/OIML approved	10 lb	775.00
85656	420, 9-36VDC nominal	10 lb	875.00
88652	420 Plus, 115VAC w/quick connect	10 lb	825.00
88653	420 Plus, 230VAC w/quick connect	10 lb	825.00

## Options/Accessories

PART #	DESCRIPTION	PRICE
85659	Analog output: selectable 0-10V, 4-20 mA	\$300.00
52948**	Panel mount kit	125.00
77925*	Revolution® scale software	35.00
85127	Additional operating manual	26.00
92777	Filter, PreVent™ vent kit	25.00
91895	Quick Connect, female connector and cable, 17 in	21.00
53640	Quick Connect, male connector and cable, 20 ft	36.00
<b>Primary Component Parts</b>		
88835	Board assembly	495.00
84397	Overlay membrane panel	60.00
76556	Power supply, auto switching	50.00
97475	DC/DC converter, 9-36 VDC	155.00
85791	Fuse, 2.5A, 5 x 20 mm	3.15

\* Revolution can be downloaded for FREE at [www.ricelake.com](http://www.ricelake.com)

\*\* Panel mount kit is not NEMA rated, consult factory for modifications.



†† CEE 7/7 plug



† NEMA 5-15 plug

# SURVIVOR® 420HE

Hostile Environment Digital Weight Indicators

## Specifications

### Excitation Voltage:

5VDC

Load current: 115 mA maximum (8 x 350 Ω load cells)

### Analog Signal Input Range:

0.5 mV/V - 3.5 microvolts/V

### Analog Signal Sensitivity:

0.3 mV/V/graduations minimum

### Measurement Rate:

60,30,15,7 1/2 updates second

### System Linearity:

Within 0.01% of FS

### Resolution:

Internal resolution: 8 million counts

Display resolution: Selectable up to 100,000dd

### Display:

2 in (50 mm) LED Display,

Decimal point available at each digit

### Status Annunciators:

Tare, entered tare, standstill, net, gross, center of zero, minus sign, lb, kg

### Front-Panel:

5-button rubber-booted watertight switches

### Circuit Protection:

ESD, EMI, RFI protected

### Serial Output:

Printer port: RS-232 full duplex 20 mA simplex

EDP Port: RS-232 full duplex

Baud rates: 300 to 38,400 7 or 8 data bits; even, odd or no parity

### Power:

Line voltages: 115 or 230VAC

Frequency: 50/60 Hz

Power consumption: 25W maximum

### Digital Inputs:

2 inputs, TTL or switch closure, active low

### Digital Outputs:

2 outputs, 250 mA max sink

### Operating Temperatures:

14°F to 104°F (-10°C to 40°C)

### Rating/Material:

NEMA 4X FRP

### Weight:

Approximately 18 lb (8.2 kg)

### Warranty:

Two-year limited warranty

### Approvals:

NTEP CC 04-076, Class III/IIIL 10,000d

Measurement Canada AM-5554, Class III/IIHD 10,000d

## DIMENSIONS

A	12.50 in (318 mm)	D	14.94 in (379 mm)
B	10.50 in (267 mm)	E	10.00 in (254 mm)
C	8.28 in (210 mm)		

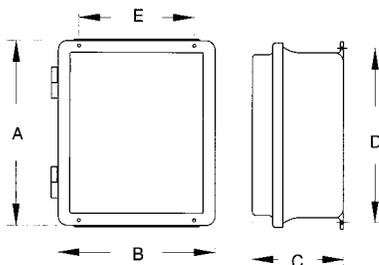

## APPROVALS



Measurement  
Canada  
Approved

## Standard Features

- NEMA 4X Fiberglass-Reinforced Polyester (FRP) enclosure
- Bright, 2 in LED display
- Universal mounting tabs (replaceable)
- Up to 60 updates/second
- Selectable display update rate
- Five button operation, environmentally protected mechanical switches
- Two communication ports, full duplex RS-232
- RATTLETRAP® vibration control
- Configurable with Revolution software

## Part Number/Price

PART #	DESCRIPTION	WEIGHT	PRICE
87959 †	SURVIVOR 420HE 115VAC	18 lb	\$1,600.00
87960 †	SURVIVOR 420HE 230VAC	18 lb	1,600.00

## Options/Accessories

PART #	DESCRIPTION	PRICE
30911	Additional mounting tabs (set of 4)	\$30.00
92777	Filter, PreVent™ vent kit	25.00
87972	Additional operating manual	25.00

### Primary Component Parts

87958	Board assembly, CPU	520.00
72996	AC power supply	90.00
87808	Board display, 2 in LED	375.00
87971	Switch assembly, 6 push button	125.00
87968	Front panel overlay	55.00



† NEMA 5-15 plug

# 480/480 Plus Legend™ Series

## Digital Weight Indicator

### Specifications

#### Power:

Line voltages: 115 - 230VAC  
 Frequency: 50 or 60 Hz  
 Power consumption: 70 mA at 115VAC,  
 35 mA at 230VAC with (10) 350Ω load cells

#### Excitation Voltage:

5VDC, 10 x 350Ω load cells

#### Analog Signal Input Range:

±7 mV/V

#### Analog Signal Sensitivity:

0.1μV/graduation minimum,  
 0.5μV/graduation recommended

#### Resolution:

Internal: 523,000 counts

#### Display:

100,000 displayed graduations

#### Measurement Rate:

Selectable 5, 10, 20, 40 Hz

#### System Linearity:

Within 0.01% of full scale

#### Circuit Protection:

Immunity 10V/m  
 ESD ± 10 KV air ± 6 KV contact

#### RFI Protection:

Capacitor bypass and ESD suppressors

#### Serial Output:

Com 1: RS-232 full duplex  
 Com 2: RS-232 full duplex or 20 mA simplex  
 Both ports 1200, 2400, 4800, 9600, 19200, 38400 baud 7 or 8 data bits, even, odd or no parity

#### Display:

0.8 in (20 mm), 6-digit super red LED display, 7-segment digits

#### Status Annunciators:

Gross, Net, Center of Zero, Standstill, lb, kg, Tare, Preset Tare

#### Keyboard:

Flat membrane panel, embossed keys, tactile feel

#### Analog Output Option:

16-bit resolution, Voltage Output 0-10VDC, current output 0-20 mA / 4-20 mA

#### Relay Board Option:

(2) Opto-isolated, 5 to 24VDC, active high inputs  
 (4) 30VDC, 2 Amp dry-contact relays,

#### Operating Temperature:

Legal: 14°F to 104°F (-10°C to 40°C)  
 Industrial: 14°F to 122°F (-10°C to 50°C)

#### Weight:

6.4 lb (2.9 kg)

#### Rating/Material:

Enclosure: NEMA 4X/IP66, heavy gauge stainless steel

#### Warranty:

Two-year limited warranty

#### Approvals:

Measurement Canada AM-5892, Accuracy Class III/II/HD, 10 000d  
 NTEP CC 12-123, Accuracy Class III/II/LL, 10 000d  
 OIML R76/2006-NL1-12.48, T5692, TC8322 Accuracy Class III, 10 000d  
 CE Marked  
 UL Marked



### APPROVALS



Measurement  
Canada  
Approved



### Standard Features

- Large 0.8 in LED display
- Time and Date, battery backed
- Nema 4X/IP66 stainless steel washdown enclosure
- Password protection for user and configuration changes
- Operator functions through menu key for Audit Trail, Preset Tare, Unit ID, Accumulator, Time & Date, Setpoints, Serial Communications, and Print Formats.
- Two independent serial ports, RS-232 and 20 mA
- Programmable ticket formats for Gross, Net, Accumulator, and Setpoints
- Local/Remote operation
- Hardware or Audit Trail sealed
- Filter settings for light, medium and heavy noise
- Selectable Conversion Rate and Display Update Rate
- Eight Setpoints, sequenced batch engine
- Configurable with Revolution software
- Numeric keypad
- Keyed entries for Tare and Setpoint values

### Options

- Analog Output, 0-10VDC, 4-20 mA, selection for 20% Offset
- Relay output, two digital inputs, four dry contact relays (supports two boards)
- Battery, rechargeable Lithium Ion
- Ethernet TCP/IP and USB Interface

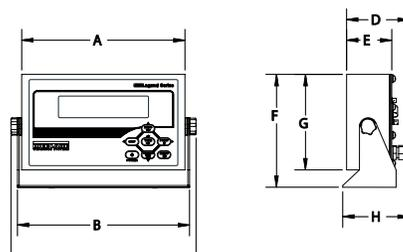

#### DIMENSIONS

A	9.50 in (241 mm)	E	2.75 in (70 mm)
B	10.00 in (254 mm)	F	7.00 in (177 mm)
C	11.00 in (279 mm)	G	6.00 in (152 mm)
D	3.65 in (92 mm)	H	3.75 in (95 mm)

# 480/480 Plus Legend Series

Digital Weight Indicator

## Part Number/Price: 480

PART #	DESCRIPTION	WEIGHT	PRICE
<b>480 115 VAC †</b>			
126564	480 LED	8 lb	\$625.00
130338	480 LED, with Analog Output	8 lb	950.00
130340	480 LED, with Relay Output	8 lb	800.00
<b>480 90-264 VAC ††</b>			
126565	480 LED	8 lb	625.00
130339	480 LED, with Analog Output	8 lb	950.00
130341	480 LED, with Relay Output	8 lb	800.00

## Part Number/Price: 480 Plus

PART #	DESCRIPTION	WEIGHT	PRICE
<b>480 Plus 115 VAC †</b>			
164588	480 Plus LED,	8 lb	625.00
164589	480 Plus LED, with Analog Output	8 lb	950.00
164590	480 Plus LED, with Relay Output	8 lb	800.00
<b>480 Plus 90-264 VAC ††</b>			
164591	480 Plus LED,	8 lb	625.00
164592	480 Plus LED, with Analog Output	8 lb	950.00
164593	480 Plus LED, with Relay Output	8 lb	800.00



†† CEE 7/7 plug  
Euro plug



† NEMA 5-15 plug

## Options/Accessories

PART #	DESCRIPTION	WEIGHT	PRICE
131340	Mounting bracket for option boards	1 lb	\$25.00
131341	Analog output, 0-10VDC, 4-20mA (requires 131340)	1 lb	300.00
131342	Relay board, 2 digital inputs, 4 dry contact outputs (requires 131340)	1 lb	150.00
164600	USB and Ethernet TCP/IP (requires 131340)		300.0
164604	Ethernet cable with cord grip, 6 feet		50.00
164602	USB cable with cord grip, Type A plug, 6 inches		50.00
164650	Battery kit, Rechargeable Litium Ion		200.00
151100	A/D sealing kit, used with Audit Trail Tracking	1 lb	30.00
151099	Panel mount bezel (not NEMA rated)	4 lb	130.00
83564	Clear protective overlay (package of five)	1 lb	65.00
77925*	Revolution scale software	1 lb	35.00
119201	Installation manual	1 lb	25.00
<b>Primary Replacement Components</b>			
131345	Overlay, 6-Key, red window	1 lb	55.00
131346	Display board, LED	1 lb	130.00
131316	Power supply, 85-265VAC	1 lb	52.00
131318	CPU board	1 lb	235.00
131319	A/D board	1 lb	180.00
159612	Overlay, 480Plus with numeric keys	1 lb	55.00

\* Revolution can be downloaded for FREE at [www.ricelake.com](http://www.ricelake.com)

# 482/482 Plus Legend™ Series

Digital Weight Indicator

## Specifications

### Power:

Line voltages: 115 - 230VAC  
Frequency: 50 or 60 Hz  
Estimated battery life: 40 hours (350 ohm load)

### Excitation Voltage:

5VDC, 8 x 350Ω load cells

### Analog Signal Input Range:

±7 mV/V

### Analog Signal Sensitivity:

0.1uV/graduation minimum,  
0.5uV/graduation recommended

### Resolution:

Internal: 523,000 counts

### Display:

100,000 displayed graduations

### Measurement Rate:

Selectable 5, 10, 20, 40 Hz

### System Linearity:

Within 0.01% of full scale

### Digital Inputs:

2 inputs (requires relay output option). Primary keys, Pseudo functions, Batching functions

### Circuit Protection:

Immunity 10V/m  
ESD ± 10KV air ± 6KV contact

### RFI Protection:

Capacitor bypass and ESD suppressors

### Serial Output:

Com 1: RS-232 full duplex  
Com 2: RS-232 full duplex or 20 mA simplex  
Both ports 1200, 2400, 4800, 9600, 19200, 38400 baud 7 or 8 data bits, even, odd or no parity

### Display:

0.8 in (20 mm), 6-digit LCD with back light  
7-segment digits

### Status Annunciators:

Gross, Net, Center of Zero, Standstill, lb, kg, Tare, Preset Tare

### Keyboard:

Flat membrane panel, embossed keys, tactile feel

### Analog Output Option:

16-bit resolution, Voltage Output 0-10VDC, current output 0-20 mA / 4-20 mA

### Relay Board Option:

(2) Opto-isolated, 5 to 24VDC, active high inputs  
(4) 30VDC, 2 Amp dry-contact relays,

### Operating Temperature:

Legal: 14°F to 104°F (-10°C to 40°C)  
Industrial: 14°F to 122°F (-10°C to 50°C)

### Weight:

6.4 lb (2.9 kg)

### Rating/Material:

Enclosure: NEMA 4X/IP66, heavy gauge stainless steel

### Warranty:

Two-year limited warranty

### Approvals:

Measurement Canada AM-5892,  
Accuracy Class III/IIHD, 10 000d  
NTEP CC 12-123,  
Accuracy Class III/IIIL, 10 000d  
OIML R76/2006-NL1-12.48, T5692, TC8322  
Accuracy Class III, 10 000d  
CE Marked



## APPROVALS



Measurement  
Canada  
Approved



## Standard Features

- Large 0.8 in LCD display
- Rechargeable battery
- Power for 40 hours of battery life on (1) ohn load
- Power sleep and wake-up threshold
- Time and date
- Two independent serial ports, RS-232 and 20 mA
- Nema 4X/IP66 stainless steel washdown enclosure
- Password protection for user and configuration changes
- Selectable Conversion Rate and Display Update Rate
- Hardware or Audit Trail sealed
- Programmable ticket formats for Gross, Net, Accumulator, and Setpoints
- Adapter filter or rolling average filter
- Numeric keypad
- Keypad entries for Tare and Setpoint values
- Configurable with Revolution software

## Options

- Analog Output, 0-10VDC, 4-20 mA, selection for 20% Offset
- Relay output, two digital inputs, four dry contact relays (supports two boards)
- Battery, rechargeable Lithium Ion

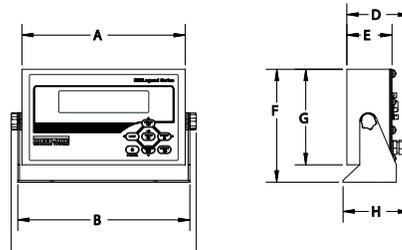

## DIMENSIONS

A	9.50 in (241 mm)	E	2.75 in (70 mm)
B	10.00 in (254 mm)	F	7.00 in (177 mm)
C	11.00 in (279 mm)	G	6.00 in (152 mm)
D	3.65 in (92 mm)	H	3.75 in (95 mm)



# 482/482 Plus Legend Series

Digital Weight Indicator

## Part Number/Price: 482

PART #	DESCRIPTION	WEIGHT	PRICE
<b>482 115 VAC †</b>			
164581	482 LCD	8 lb	\$725.00
164582	482 LCD with internal battery	8 lb	925.00
<b>482 90-264 VAC ††</b>			
164672	482 LCD	8 lb	725.00
164583	482 LCD with internal battery	8 lb	925.00

## Part Number/Price: 482 Plus

PART #	DESCRIPTION	WEIGHT	PRICE
<b>482 Plus 115 VAC †</b>			
164584	482 Plus LCD,	8 lb	725.00
164585	482 Plus LCD, with internal battery	8 lb	925.00
<b>482 Plus 90-264 VAC ††</b>			
164673	482 Plus LCD,	8 lb	725.00
164586	482 Plus LCD, with internal battery	8 lb	925.00

## Options/Accessories

PART #	DESCRIPTION	WEIGHT	PRICE
131340	Mounting bracket for option boards	1 lb	\$25.00
131341	Analog output, 0-10VDC, 4-20mA (requires 131340)	1 lb	300.00
131342	Relay board, 2 digital inputs, 4 dry contact outputs (requires 131340)	1 lb	150.00
164650	Battery kit, Rechargeable Litium Ion	1 lb	200.00
151100	A/D sealing kit, used with Audit Trail Tracking	1 lb	30.00
151099	Panel mount bezel (not NEMA rated)	4 lb	130.00
83564	Clear protective overlay (package of five)	1 lb	65.00
*77925	Revolution scale software	1 lb	35.00
165124	Installation manual	1 lb	25.00
<b>Primary Replacement Components</b>			
161048	Overlay, 6-Key, clear window	1 lb	55.00
161049	Overlay with numeric keys, clear window	1 lb	55.00
153776	Display board, LCD	1 lb	125.00
131316	Power supply, 85-265VAC	1 lb	52.00
131318	CPU board	1 lb	235.00
131319	A/D board	1 lb	180.00

\* Revolution can be downloaded for FREE at [www.ricelake.com](http://www.ricelake.com)



†† CEE 7/7 plug  
Euro plug



† NEMA 5-15 plug

# IQ plus® 590-DC

Battery Powered Digital Weight Indicator

## Specifications

### Power:

9VDC, provided by 6 C-cell alkaline batteries  
or AC adapter

### Power Consumption:

100 mA (100 hours with 4 load cells)  
25 mA (300 hours with 1 load cell)

### Excitation Voltage:

5VDC, 4 x 350Ω or 8 x 700Ω load cells

### Analog Signal Input Range:

-2.5 mV – 22.5 mV

### Analog Signal Sensitivity:

0.3 μV/graduation minimum  
1.5 μV/grad recommended

### Resolution:

Internal resolution: 1 million counts  
Display resolution: 100,000 dd

### Counting Capacity:

100,000 pieces

### Measurement Rate:

30, 15, 7 1/2, 33/4 per second

### System Lin

Within 0.01% of full scale

### Serial Communications:

EDP/Printer port: Full duplex RS-232

### Display:

1 in (24.5 mm) 6-digit Liquid Crystal Display (LCD)

### Circuit Protection:

RFI, EMI, ESD protection

### Annunciators:

Units (lb/kg), piece count mode (PC), gross, net, standstill, center of zero, tare, low battery

### Keyboard:

19-key flat membrane panel, tactile feel

### Operating Temperature:

Legal: 14°F to 104°F (-10°C to 40°C)  
Industrial: 14°F to 122°F (-10°C to 50°C)

### Weight:

6.5 lb (2.95 kg)

### Rating/Material:

NEMA 4X/IP66, stainless steel

### Warranty:

Two-year limited warranty

### Approvals:

NTEP CC 98-203, Class III/IIIL 10,000d  
Measurement Canada AM-5300, Class III 10,000d, Class IIIHD 20,000d  
CE marked  
UL & C-UL listed



## APPROVALS



Measurement  
Canada  
Approved



## Standard Features

- Full numeric keypad
- Keyboard entry of piece weight, tare weight, calibration and sample size
- Display tare button
- Powered by 6 "C" cell alkaline batteries for complete portability (batteries not included)
- Three 300-character print ticket formats
- Power for four 350 Ohms load cells or eight 700 Ohms load cells
- Supports 4- and 6-wire load cell connections
- EDP port for full duplex, RS-232 communications
- NEMA 4X/IP66-rated stainless steel enclosure
- Large 1 in (24.5 mm), six-digit Liquid Crystal Display (LCD)
- AC adapter for 115 or 230VAC power
- Configurable standby mode to prolong battery life
- RATTLETRAP® three-stage digital filtering
- Configurable units multiplier
- Configurable analog-to-digital measurement rate
- Self-resetting thermal fuse
- Configurable with Revolution software

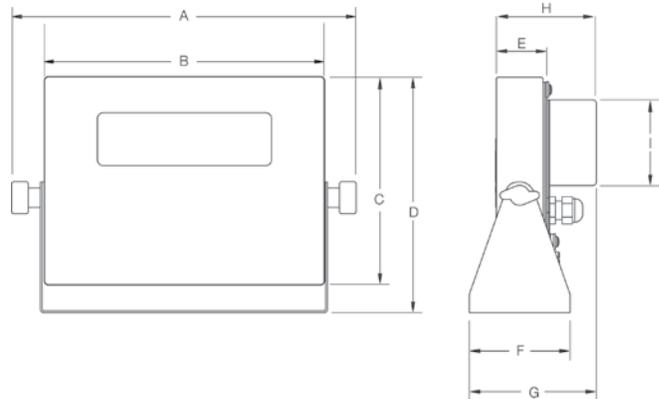

## DIMENSIONS

A	11.0 in (280 mm)	F	3.2 in (82 mm)
B	9.0 in (229 mm)	G	4.1 in (104 mm)
C	6.5 in (166 mm)	H	2.9 in (73 mm)
D	7.5 in (190 mm)	I	2.9 in (73 mm)
E	1.6 in (41 mm)		

# IQ plus® 590-DC

Battery Powered Digital Weight Indicator

## Part Number/Price

PART #	DESCRIPTION	EST. SHIP WEIGHT	PRICE
52486 †	IQ plus 590-DC, battery powered w/115VAC wall adapter	6.5 lb	\$800.00
52485 ††	IQ plus 590-DC battery powered w/230VAC wall adapter	6.5 lb	800.00
66728	IQ plus 590-DC, CE marked (voltage adapter sold separately)	6.5 lb	775.00
53630 †	IQ plus 590-DC with 115 VAC wall adapter with quick connect	6.5 lb	850.00
53633 ††	IQ plus 590-DC with 230 VAC wall adapter with quick connect	6.5 lb	850.00

## Options/Accessories

PART #	DESCRIPTION	PRICE
77925*	Revolution® scale software	\$35.00
51778	Additional operating manual	25.00
83566	Clear protective overlay (package of five)	60.00
92777	Filter, PreVent™ vent kit	25.00
<b>Primary Component Parts</b>		
49978	Power supply, 115VAC	25.00
130185	Power supply, 230VAC (2-Pin Europe)	35.00
51972	Overlay membrane panel	60.00
52469	Board assembly	495.00

\* Revolution can be downloaded for FREE at [www.ricelake.com](http://www.ricelake.com)



†† CEE 7/7 plug



† NEMA 5-15 plug

# 720i™

## Programmable HMI Indicator/Controller

### Specifications

**Power:**

Line voltages: 115 or 230VAC,  
Frequency: 50 or 60 Hz  
Power consumption: 25 watts maximum

**Excitation Voltage:**

10VDC, 16 x 350Ω or 32 x 700Ω load cells

**Analog Signal Input Range:**

-10 mV to +45 mV

**Analog Signal Sensitivity:**

0.3 μV/graduation minimum at 7.5 Hz  
1.0 μV/graduation typical at 120 Hz  
4.0 μV/graduation typical at 960 Hz

**A/D Sample Rate:**

7.5 to 960 Hz, software selectable

**Resolution:**

Internal resolution: 8 million counts/8,000,000 23 bit  
Weight display resolution: 9,999,999

**System Linearity:**

± 0.01% full scale

**Digital I/O:**

Eight channels on CPU board; optional 24-channel I/O

**Circuit Protection:**

RFI, EMI, ESD protection

**Serial Ports:**

Two ports on CPU board support up to 115,200 bps; optional dual-channel serial expansion boards available

Port 2: Full duplex RS-232 with handshaking

Port 4: Full duplex RS-232, simplex 20 mA output

PS-2 Keyboard port hard wired (Scan Code 1)

**Optional Communication:**

Ethernet TCP/IP

RS-485-4 wire

Fiber optic

USB

**Display:**

Viewable area:

Panel mount 3.8 x 1.2 in (96 x 30 mm)

Universal 5.3 x 1.5 in (133 x 39 mm)

240 x 64 pixel, Transflective VGA Liquid Crystal Display (LCD) module with adjustable contrast

**Keyboard:**

10-key (panel mount) membrane panel,

22-key (universal mount) membrane panel tactile feel,

720i will support an external keyboard

**Operating Temperature:**

Legal: 14°F to 104°F (-10°C to 40°C)

Industrial: 14°F to 122°F (-10°C to 50°C)

**Weight:**

Universal enclosure: 9.5 lb (4.3 kg)

Panel Mount enclosure: 8.5 lb (3.9 kg)

**Rating/Material:**

NEMA 4X/IP66, stainless steel

**Warranty:**

Two-year limited warranty

**Approvals:**

NTEP CC 08-022, Class III/IIIL 10,000d

Measurement Canada AM 5426 10,000d Class III/IIHHD

OIML UK 2893 6,000/10,000d

CE marked

UL /CUL listed (universal)

UL recognized (panel mount)

ROHS compliant



Universal



Panel Mount



CPU Enclosure

### APPROVALS



Measurement  
Canada  
Approved



### Standard Features

- LCD display size: panel mount (3.8 in x 1.2 in), universal (5.3 x 1.5 in)
- Four soft keys
- Truck in/out, 1,000-ID memory
- Process control engine ProAction PCE define conditions and actions
- Data storage onboard, ProAction DBE user-defined
- Eight Digital I/O (expandable)
- One option slot for pluggable options
- (20) Auxiliary print formats
- Time & date
- Audit trail tracking and alibi storage
- Peak hold
- Rate of change
- Accumulator
- Multi-range/interval
- Local/remote
- Two full duplex serial ports
- One PS-2 keyboard port
- Header for fiber optic, Ethernet or USB
- Configurable with Revolution software

# 720i™

Programmable HMI Indicator/Controller

## Part Number/Price

PART #	DESCRIPTION	EST. SHIP WEIGHT	PRICE
<b>PCE Software</b>			
101230 †	720i Universal 115/230VAC	12 lb	\$1,200.00
103459 ††	720i Universal 115/230VAC, CE/OIML marked	12 lb	1,200.00
107708	720i Universal, 9-36VDC	12 lb	1,300.00
101229**	720i Panel Mount 115/230 VAC	12 lb	1,200.00
119116**	720i Panel Mount 115/230 VAC, CE/OIML marked	12 lb	1,200.00
107710	720i Panel Mount, 9-36VDC	12 lb	1,300.00
<b>Batch Software</b>			
115447 †	720 Universal 115/230 VAC	12 lb	1,200.00
115448 ††	720 Universal 115/230 VAC CE/OIML marked	12 lb	1,200.00
115449	720i Panel Mount 115/230 VAC	12 lb	1,200.00

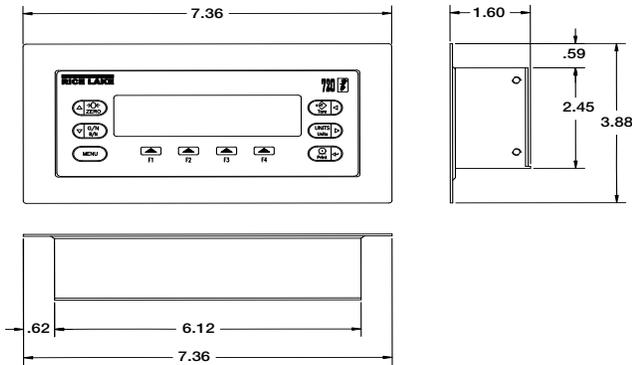

720i Panel Mount Display

NOTE: Panel Mount CPU enclosure measures 12.75 in (L) x 6.05 in (W) x 2.14 in (H)

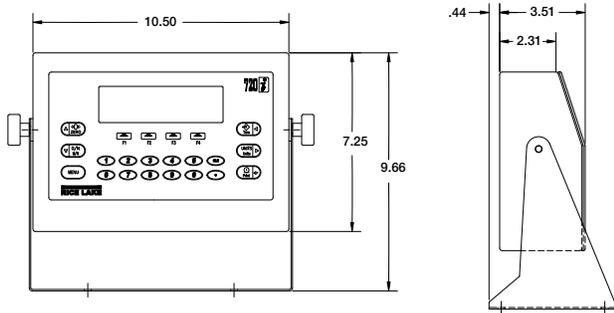

720i Universal

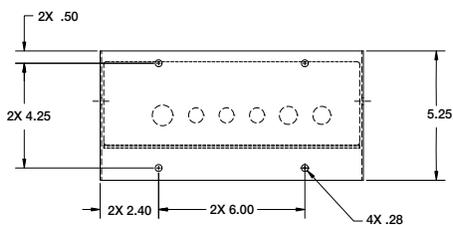

## Options/Accessories

PART #	DESCRIPTION	PRICE
<b>Option Cards</b>		
67601	Digital I/O, 24-channel	\$260.00
67602	Analog output: selectable 0-10V, 0-20 mA	300.00
67604	Serial, dual channel	310.00
93245	USB Port (PC connection only-replaces serial port 2)	160.00
<b>Network Cards</b>		
77142	Ethernet TCP/IP Port (replaces serial port 2)	400.00
71986	Ethernet TCP/IP module (installed in option slot)	400.00
87803	Ethernet IP (specifically for A-B PLC)	800.00
108671	Wireless LAN Card 802.11 A/B	570.00
68539	Allen-Bradley Remote I/O interface (limited supply)	650.00
68540	Profibus™ DP interface	650.00
68541	DeviceNet™ interface	650.00
<b>Hardware</b>		
15436	Power cord for panel mount NEMA 5-15 plug	17.00
105382	Power cord for panel mount CEE 7/7 plug	17.00
96736	Fiber optic board (replaces serial port 2)	200.00
93359	PS/2 Keyboard	45.00
92777	Filter PreVent™ vent kit	25.00
19369	Start/stop switch box	300.00
83570	Clear protective overlay (package of five)	65.00
118975	Panel mount kit, for Universal	150.00
30549	Relay rack	150.00
<b>Manuals &amp; Software</b>		
103121	Installation manual	25.00
104033	720i toolkit CD	35.00
107622	720i ProAction Simulator CD	295.00
<b>Primary Component Parts</b>		
106788	CPU board assembly	780.00
101244	LCD Display (panel mount) transfective	130.00
102888	LCD Display (universal) transfective	130.00
101239	Display board (with display for panel mount)	300.00
102887	Display board (w/o display for universal)	260.00
67613	AC power supply	135.00
97474	DC/DC converter 9-36 nominal, 25 watt	160.00
101256	Switch membrane for panel mount	55.00
101257	Switch membrane for universal	65.00

\*DC/DC converter installed option, requires serial tag charge, not UL approved

\*\*Power cord sold separately



# 820i®

## Programmable HMI Indicator/Controller

### Specifications

**Power:**

Line voltages: 115 or 230 VAC,  
Frequency: 50 or 60 Hz  
Power consumption: 25 watts maximum

**Excitation Voltage:**

10 VDC, 16 x 350 Ω or 32 x 700 Ω load cells  
Analog Signal Input Range:  
-10 mV to +45 mV

**Analog Signal Sensitivity:**

0.3 μV/graduation minimum at 7.5 Hz  
1.0 μV/graduation typical at 120 Hz  
4.0 μV/graduation typical at 960 Hz

**A/D Sample Rate:**

7.5 to 960 Hz, software selectable

**Resolution:**

Internal resolution: 8 million counts/8,000,000 23 bit  
Weight display resolution: 9,999,999

**System Linearity:**

± 0.01% full scale

**Digital I/O:**

Eight channels on CPU board; optional  
24-channel I/O expansion boards available

**Circuit Protection:**

RFI, EMI, ESD protection

**Serial Ports:**

Two ports on CPU board support up to 115,200 bps; optional dual-channel serial expansion boards available  
Port 2: Full duplex RS-232 with handshaking  
Port 4: Full duplex RS-232, 2-wire, RS-485, 20 mA output  
External keyboard port

**Optional Communication:**

Ethernet TCP/IP  
RS-485-4 wire  
Fiber optic  
USB

**Display (W x H):**

Viewable area: 4.6 in x 2.2 in (116 mm x 55 mm), 320 x 156 pixel VGA Liquid Crystal Display (LCD) module with adjustable contrast.  
Transmissive display- standard  
Transflective display - option

**Keyboard:**

28-key membrane panel, tactile feel, 820i will support an external keyboard connection

**Operating Temperature:**

Legal: 14°F to 104°F (-10°C to 40°C)  
Industrial: 14°F to 122°F (-10°C to 50°C)

**Dimensions (W x H x D):**

Universal: 10.5 x 11.2 x 4.5 in  
(266 x 217 x 114 mm)  
Panel Mount: 11.6 x 9.2 x 5.2 in  
(294 x 231 x 127 mm)

**Weight:**

Universal enclosure: 9.5 lb (4.3 kg)  
Panel Mount enclosure: 8.5 lb (3.9 kg)

**Rating/Material:**

NEMA 4X/IP66, stainless steel

**Warranty:**

Two-year limited warranty

**Approvals:**

NTEP CC 01-088, Class III/IIL 10,000d  
Measurement Canada AM-5426 Class III/IIHD 10,000d  
OIML UK 2658, 6,000/10,000d  
CE marked  
UL /CUL listed (universal)  
UL recognized (panel mount)  
ROHS compliant



Universal



Panel Mount

### APPROVALS



Measurement  
Canada  
Approved



### Standard Features

- Large (4.6 in W x 2.2 in H, 320 x 156 pixel) back-lit LCD display
- Weight display from .5 in to .75 in
- Display up to two scales (scale 1, scale 2 and total)
- Five user-defined soft keys
- Weight or millivolt calibration with linearization and geographical compensation
- NEMA 4X/IP66 stainless steel enclosure
- Selectable A-D measurement rate up to 960/second
- Power for 16, 350 ohm load cells
- 100 setpoints, latched or free-running
- Multi-range/Internal
- Peak Hold, Rate of Change
- Audit Trail Tracking and Alibi Software
- One option slot for pluggable options
- 1000 - ID truck register for in/out weighing
- User programmable 256K flash memory
- Onboard data storage 190K
- Downloadable programs
- Visual programming for easily creating custom programs
- Eight digital I/O (expandable)
- Configurable with Revolution software

# 820i™

Programmable HMI Indicator/Controller

## Part Number/Price

PART #	DESCRIPTION	EST. SHIP WEIGHT	PRICE
<b>Single Channel</b>			
91995 †	820i Universal, 115VAC	10 lb	\$1,530.00
91996 †	820i Universal, 230VAC	10 lb	1,530.00
91997 ††	820i Universal, 230VAC CE/OIML	10 lb	1,530.00
107711	820i Universal, 9-36VDC nominal	10 lb	1,600.00
93424 †	820i Panel Mount, 115VAC	9 lb	1,530.00
98280 ††	820i Panel Mount, 230VAC, CE/OIML	9 lb	1,530.00
107712	820i Panel Mount, 9-36VDC nominal	9 lb	1,600.00
<b>Dual Channel</b>			
93011 †	820i Universal, 115VAC	10 lb	1,630.00
93012 †	820i Universal, 230VAC	10 lb	1,630.00
93013 ††	820i Universal, 230VAC CE/OIML	10 lb	1,630.00
93425 †	820i Panel Mount, 115VAC	9 lb	1,630.00
98281 ††	820i Panel Mount, 230VAC, CE/OIML	9 lb	1,630.00

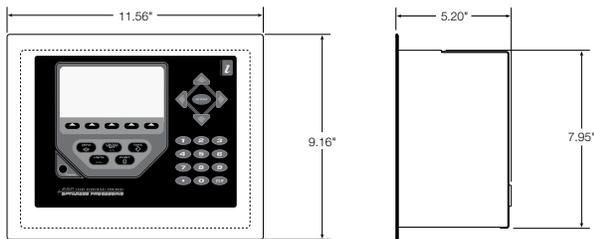
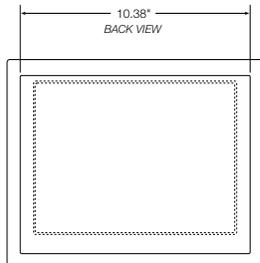

820i Panel Mount



820i Universal Mount

## Options/Accessories

PART #	DESCRIPTION	PRICE
<b>Option Cards</b>		
67601	Digital I/O, 24-channel	\$260.00
67602	Analog output: selectable 0-10V, 0-20 mA	300.00
103138	Analog output, dual channel 0-10V, 0-20 mA (requires version 1.04)	525.00
67604	Serial, dual channel	310.00
87697	Analog input +/-10VDC, 0-20 mA & thermocouple	585.00
93245	USB Port (PC connection only-replaces serial port)	160.00
<b>Network Cards</b>		
77142	Ethernet TCP/IP Port (serial port 2 header)	400.00
65383	Ethernet thin server (external)	295.00
71986	Ethernet TCP/IP module (installed in option slot)	400.00
98057	Wireless LAN card 802.11 B/G (installed in option slot)	650.00
108671	Wireless LAN card 802.11 A/B (serial port 2 header)	570.00
68539	Allen-Bradley Remote I/O interface (limited supply)	650.00
68540	Profibus® DP interface	650.00
68541	DeviceNet™ interface	650.00
87803	EtherNet/IP (specifically for A-B PLC)	800.00
103136	ControlNet interface	1,000.00
<b>Hardware</b>		
154077	Scanner, DS457-SR, RS-232, requires power source	600.00
96736	Fiber optic board	200.00
93359	PS/2 keyboard	45.00
83569	Clear protective overlay (package of five)	65.00
92777	Filter PreVent™ vent kit	25.00
19369	Start/stop switch box	300.00
100758	Sunlight viewable display, transfective installed option, replaces transmissive display	275.00
<b>Manuals and Software</b>		
93018	Installation manual	25.00
77925	Revolution® scale software	35.00
93019	IRITE IDE software (version 1.0 included with indicator)	95.00
<b>Primary Component Parts</b>		
102331	CPU board assembly-single channel	895.00
102333	CPU board assembly-dual channel	995.00
93246	Display board assembly	265.00
67613	Power supply assembly, 25 watt	135.00
97474	DC/DC converter, 9-36VAC, nominal, 25 watt	160.00
93247	Switch panel membrane	68.00

Relay products can be found on page 403



†† CEE 7/7 plug



† NEMA 5-15 plug

# 880/880 Plus Performance™ Series

Digital Weight Indicator/Controller



## Specifications

### Power:

Input voltages: 100-240 VAC; 9-36 VDC Input frequency: 47-63 Hz

### Power Consumption:

AC: 15 watts; DC: 20 watts

### Excitation Voltage:

10 VDC 8 x 350 Ω (16 x 700 Ω) load cells

### Analog Signal Input Range:

-45 mV to 45 mV

### Analog Signal Sensitivity:

0.3 μV/graduation minimum at 7.5 Hz; 1.0 μV/graduation typical at 120 Hz

4.0 μV/graduation typical at 960 Hz; A/D Sample Rate:

7.5 to 960 Hz, software selectable

### Resolution:

Internal: 8 million counts/8,000,000 23 bit, Weight display: 100,000

### System Linearity:

± 0.01% Full Scale

### Digital I/O:

Four I/O Onboard Primary keys, pseudo functions, batching functions

### Circuit Protection:

18 KV, 10V/meter

### Communication Ports:

RS-232 Full Duplex or RS-485 Half Duplex; USB Type A Connector 2.0 (firmware update required); USB Micro A/B Connector 2.0; Ethernet TCP/IP

### Display:

LED, Six 0.56 inch (14 mm), 14 Segment with Decimal or Comma

### Status Annunciators:

Gross, Net, Center of Zero, Standstill, lb, kg, Tare, Preset Tare, Range 1/2/3

### Keyboard:

Flat membrane panel, tactile feel

## OPTIONS

### Analog Output:

16-bit resolution, Voltage Output 0-10VDC, Current Output 0-20 mA, 4-20 mA

### Relay Board:

(4) Dry Contact Relays; DC Max: 30VDC at 3 Amps per contact

AC Max: 250VAC at 3 Amps per contact

### EtherNet/IP Interface:

According to EN 50325-2

### ProfiNet Interface:

According to IEC 61784 (CPF-3/3)

### Modbus/TCP Interface:

Up to eight bytes of I/O data, 100 Mbps full duplex Ethernet

### DeviceNet Interface:

According to EN 50325-2

### Profibus DP Interface:

According to EN 50170

### Operating Temperature:

Legal: 14°F to 104°F (-10°C to 40°C) Industrial: 14°F to 122°F (-10°C to 50°C)

### Dimensions (W x H x D):

Panel: 6 x 4 x 4.95 in (152 x 102 x 126 mm)

Universal: 9.87 x 9.38 x 4.33

### Weight:

Panel: 2.5 lb (1.2 kg); Universal: 12 lb (5.4 kg)

### Rating:

Display Bezel NEMA 4X, IP69K

### Material:

Panel Display: Stainless Steel

Universal: Stainless Steel

Controller: Aluminum

### Warranty:

Two-year limited warranty

### Approvals:

NTEP CC 13-080 Accuracy Class III/III-L, 10,000d

Measurement Canada (Pending) Accuracy Class III/IIIHD, 10,000d

OIML

CE Mark

UL listed (panel mount)

UL pending (universal)

## APPROVALS



Measurement  
Canada  
Approved

## Standard Features

- LED Display, 0.56 inch (14 mm), 14 segment
- RS-232 or RS-485 Serial Port
- USB Device
- Ethernet TCP/IP
- AC or DC models
- Built-in DIN-rail clips on controller box
- Display and controller can be separated up to 250 ft
- Hardware slot for one option card
- Operator functions through Menu key for Audit Trail, Preset Tare, Accumulator, Time & Date and Setpoints
- Audit trail tracking for configuration and calibration changes. Password protection for user and configuration changes.
- 20 Setpoints with latched batch engine or unlatched outputs
- Four onboard digital I/O
- Programmable ticket formats up to 1000 characters for Header Text, Gross, Net, Accumulator, and Setpoints
- Local/Remote operation
- Multi range or multi interval weighing
- Filter settings for light, medium and heavy noise
- Configurable with Revolution software

## Options/Accessories

- Analog output, 0-10VDC, 0-20 mA, 4-20 mA
- Relay output, four dry contact relays normally open (SPST)
- Interface for ProfiNet®, Profibus®, Modbus TCP®, EtherNet/IP®, and DeviceNet® protocols
- Metrological hardware sealing kit
- Adapter plate for converting 310A and 520 panel mounts



# 880/880 Plus Performance™ Series

Digital Weight Indicator/Controller

## Part Number/Price

PART #	DESCRIPTION	EST. SHIP WEIGHT	PRICE
<b>Panel Mount AC Powered*</b>			
150678	880, 115-230VAC with display	4 lb	\$995.00
151672	880 controller only 115-230VAC	4 lb	700.00
157989	880, 115-230VAC with Analog Output	4 lb	1,295.00
157990	880, 115-230VAC with Relay Board	4 lb	1,295.00
157991	880, 115-230VAC with EtherNet/IP	4 lb	1,545.00
157992	880, 115-230VAC with ProfiNet	4 lb	1,545.00
157994	880, 115-230VAC with Modbus/TCP	4 lb	1,545.00
157993	880, 115-230VAC with Profibus DP	4 lb	1,545.00
157995	880, 115-230VAC with DeviceNet	4 lb	1,545.00
<b>Panel Mount DC Powered*</b>			
150679	880, 9-36VDC with display	4 lb	1,095.00
151673	880 Controller only 9-36VDC	4 lb	800.00
<b>Universal Models AC Powered</b>			
163984†	880 Plus, 115 VAC	8 lb	1,195.00
165142††	880 Plus, 115-230VAC	8 lb	1,195.00

\*Power cable not included



†† CEE 7/7 plug



† NEMA 5-15 plug

## Options/Accessories

PART #	DESCRIPTION	EST. SHIP WEIGHT	PRICE
151674	880 Display only	2 lb	\$315.00
156964	Analog output, 0-10VDC, 0-20mA, 4-20mA	1 lb	300.00
156965	Relay board, 4 dry contact outputs	1 lb	300.00
156554	EtherNet/IP Interface	1 lb	550.00
156555	ProfiNet Interface	1 lb	550.00
156557	Modbus/TCP Interface	1 lb	550.00
156558	DeviceNet Interface	1 lb	550.00
156556	Profibus DP Interface	1 lb	550.00
153660	Metrological sealing kit	1 lb	10.00
158404	Adapter plate for IQ310 and 520 replacement	1 lb	45.00
77925	Revolution™ scale software	1 lb	35.00
152240	Operators manual	1 lb	25.00
158387	Technical manual	1 lb	25.00
<b>Cables</b>			
15436	Power cord, pigtail	1 lb	17.00
105382	Power cord, 230 VAC	1 lb	17.00
152434	Cable, USB A to micro A Shielded, 2 Meters L	1 lb	35.00
156817	Cable, Ethernet TCP/IP CAT.5E Shielded RoHS compliant Blue RJ45 connectors 1 meter	1 lb	30.00
156818	Cable, Ethernet TCP/IP CAT.5E Shielded RoHS compliant Blue RJ45 connectors 3 meter	1 lb	37.00
156821	Cable, Ethernet TCP/IP CAT.5E Shielded RoHS compliant Blue RJ45 connectors 5 meter	1 lb	45.00
<b>Primary Component Parts</b>			
131740	Overlay, Panel Mount, 6-Key	1 lb	55.00
163986	Overlay, Universal 880 Plus		65.00
131598	Display Board	1 lb	200.00
131599	Power Supply, 85-265 VAC	1 lb	155.00
153510	Power Supply, 9-36VDC	1 lb	255.00
131597	CPU Board	1 lb	515.00

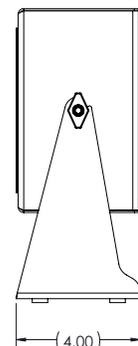
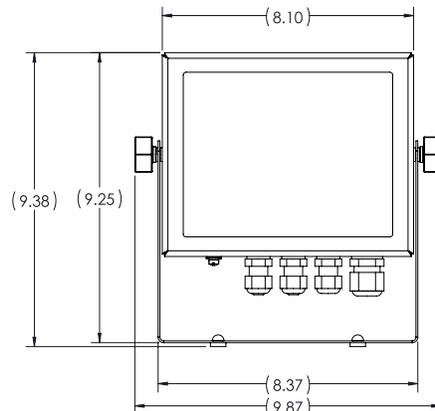
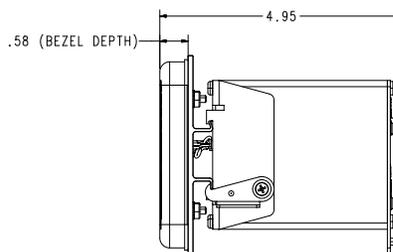
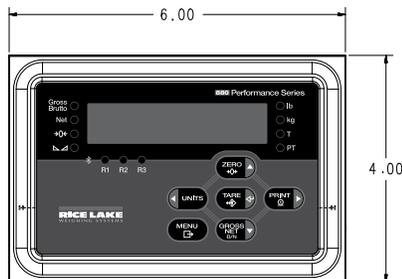

# 920i<sup>®</sup>

## Programmable HMI Indicator/Controller

### Specifications

**Power:**

Line voltages: 115 or 230VAC  
Frequency: 50 or 60 Hz  
Power consumption: 340 mA, maximum at 115VAC (26W) 240 mA at 230VAC (26W)

**Excitation Voltage:**

10 ± VDC, 16 x 350 Ω or 32 x 700 Ω load cells per A/D card

**Analog Signal Input Range:**

-10 mV to +45 mV

**Analog Signal Sensitivity:**

0.3 μV/graduation minimum at 7.5 Hz  
1.0 μV/graduation typical at 120 Hz  
4.0 μV/graduation typical at 960 Hz

**A/D Sample Rate:**

7.5 to 960 Hz, software selectable

**Resolution:**

Internal resolution: 8 million counts  
Weight display resolution: 9,999,999

**System Linearity:**

± 0.01% full scale

**Digital I/O:**

Six I/O channels on CPU board; optional 24-channel I/O expansion boards available

**Circuit Protection:**

RFI, EMI, ESD protection

**Serial Ports:**

Four ports on CPU board support up to 115,200 bps; optional dual-channel serial expansion boards available  
Port 1: Full duplex RS-232  
Port 2: RS-232 with CTS/RTS; PS/2 keyboard interface via DB-9 connector  
Port 3: Full duplex RS-232, 20 mA output  
Port 4: Full duplex RS-232, 2-wire RS-485, 20 mA output

**Display (W x H):**

4.6 in x 3.4 in (116 W x 86 mm H), 320 x 240 pixel VGA Liquid Crystal Display (LCD) module with adjustable contrast. Transmissive display, standard. Transflective display, option.

**Keyboard:**

27-key membrane panel, tactile feel, PS/2 port for external keyboard connection

**Operating Temperature:**

Legal: 14°F to 104°F (-10°C to +40°C)  
Industrial: 14°F to 122°F (-10°C to +50°C)

**Weight:**

Universal enclosure: 9.5 lb (4.3 kg)  
Wall Mount enclosure: 23.0 lb (10.4 kg)  
Panel Mount enclosure: 8.5 lb (3.9 kg)  
Deep Universal: 11 lb (5.0 kg)

**Rating/Material:**

NEMA 4X/IP66, stainless steel

**Warranty:**

Two-year limited warranty

**Approvals:**

NTEP CC 01-088, Class III/III 10,000d  
Measurement Canada AM-5426, Class III/III HD 10,000d  
OIML approved 6,000/10,000, UK 2658  
CE marked  
UL & C-UL listed (Universal, Deep and Wall Mount Enclosure)  
Custom Wall Mount approved for 508A (Optional)  
Panel Mount UL recognized



### APPROVALS



### Standard Features

- Large (4.6 W x 3.4 in H, 320 x 240 pixel) backlit LCD graphical display
- Selectable character sizes from 0.25 to 1.2 in
- 60 configurable operator prompts
- Display up to four scale channels per screen with required Legal for Trade information
- 32 scale accumulators
- Five soft keys with 10 user-defined, 14 preset functions per screen
- Ten programmable display screens
- Millivolt calibration, 5-point linearization and geographical calibration
- NEMA 4X/IP66 stainless steel enclosure
- Selectable A/D measurement rate up to 960/second
- 100 setpoints, 30 configurable setpoint types
- Two slots for option cards
- 1,000-ID truck register for in/out weighing
- 64K user on-board NV RAM
- User programmable 128K flash memory
- Reflash memory to upgrade firmware
- Power for 16, 350 Ohms load cells per A/D board
- Local-remote indicators
- Multi range/interval
- Alibi storage
- Audit trail tracking
- Peak hold
- Rate of change

# 920i<sup>®</sup>

Programmable HMI Indicator/Controller

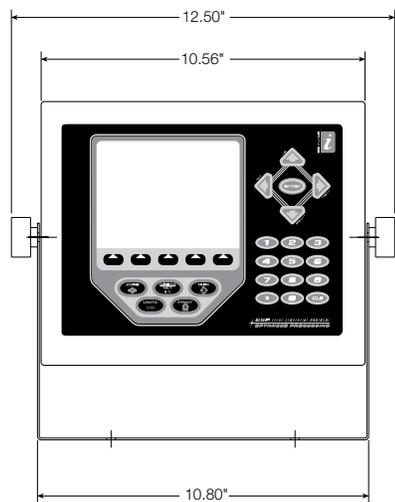

920i Universal

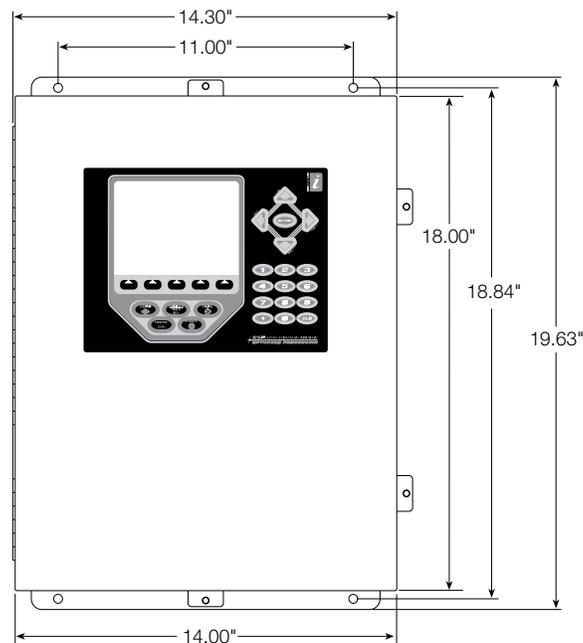
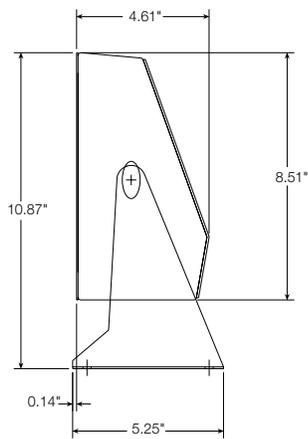

920i Deep Enclosure

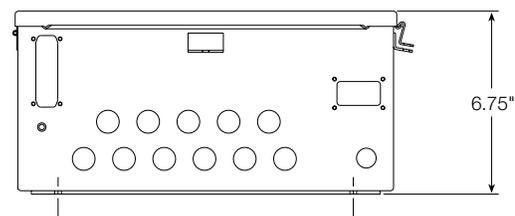
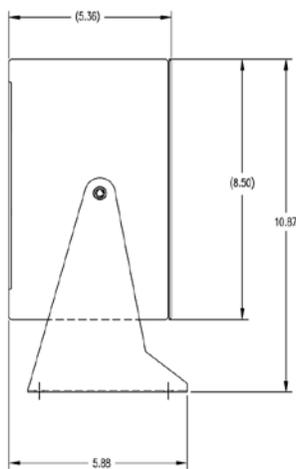

920i Wall Mount

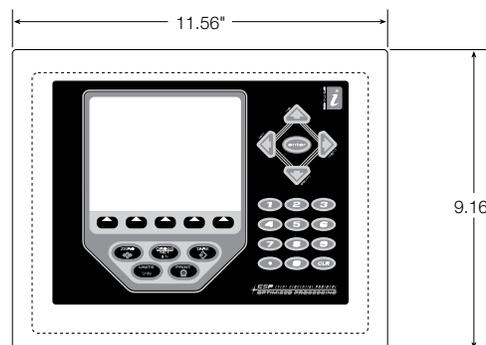

920i Panel Mount

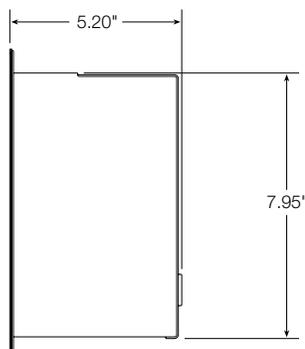

**Part Number/Price**

PART #	DESCRIPTION	EST. SHIP WEIGHT	PRICE
<b>Single Channel - 115 VAC†</b>			
67527	920i Universal	10 lb	\$1,900.00
82455	920i Deep Universal	12 lb	2,100.00
69763	920i Wall Mount, stainless steel	23 lb	2,500.00
69764	920i Panel Mount, stainless steel bezel	9 lb	1,900.00
<b>Single Channel - 230 VAC†</b>			
67615	920i Universal	10 lb	1,900.00
82457	920i Deep Universal	12 lb	2,100.00
69765	920i Wall Mount	23 lb	2,500.00
69766	920i Panel Mount	9 lb	1,900.00
<b>Single Channel - 230 VAC with Euro plug ††</b>			
69522	920i Universal	10 lb	1,900.00
82459	920i Deep Universal	12 lb	2,100.00
72133	920i Wall Mount	23 lb	2,500.00
72137	920i Panel Mount	9 lb	1,900.00
<b>Single Channel - 9-36 VDC</b>			
107713	920i Universal, 25 watt	10 lb	2,000.00
107714	920i Deep Universal, 25 watt	12 lb	2,200.00
107715	920i Wall Mount, 25 watt	23 lb	2,600.00
107716	920i Panel Mount, 25 watt	9 lb	2,000.00
<b>Dual Channel - 115 VAC†</b>			
69767	920i Universal	10 lb	2,000.00
82456	920i Deep Universal	12 lb	2,200.00
69770	920i Wall Mount	23 lb	2,600.00
69771	920i Panel Mount	9 lb	2,000.00
<b>Dual Channel - 230 VAC†</b>			
69772	920i Universal	10 lb	2,000.00
82458	920i Deep Universal	12 lb	2,200.00
69776	920i Wall Mount	23 lb	2,600.00
69777	920i Panel Mount	9 lb	2,000.00
<b>Dual Channel - 230 VAC with Euro plug††</b>			
69774	920i Universal	10 lb	2,000.00
82460	920i Deep Universal	12 lb	2,200.00
72134	920i Wall Mount	23 lb	2,600.00
72138	920i Panel Mount	9 lb	2,000.00
<b>No A-D Channel - 115 VAC†</b>			
77790	920i Universal, without A/D channel	10 lb	1,750.00
93243	920i Deep Universal, without A/D channel	12 lb	1,950.00
77794	920i Wall Mount, without A/D channel	23 lb	2,350.00
77792	920i Panel Mount, without A/D channel	9 lb	1,750.00
<b>No A-D Channel - 230 VAC††</b>			
77791	920i Universal, without A/D channel	10 lb	1,750.00
93244	920i Deep Universal, without A/D channel	12 lb	1,950.00
77795	920i Wall Mount, without A/D channel	23 lb	2,350.00
77793	920i Panel Mount, without A/D channel	9 lb	1,750.00



†† CEE 7/7 plug



† NEMA 5-15 plug

**Options/Accessories**

PART #	DESCRIPTION	PRICE
<b>Option Cards</b>		
68532	A/D, single channel	\$260.00
68533	A/D, dual channel	410.00
67600	Memory, 1 MB NV RAM	260.00
67601	Digital I/O, 24-channel TTL output	260.00
67602	Analog output: selectable 0-10V, 0-20 mA	300.00
103138	Analog output, dual channel 0-10V, 0-20 mA	525.00
67603	Pulse input, single channel	260.00
67604	Serial port card, dual channel, RS-232 and RS-485	310.00
87697	Analog input +/-10VDC, 0-20 mA and thermocouple	585.00
<b>Network Cards</b>		
65383	Ethernet Thin Server (external)	295.00
71986	Ethernet TCP/IP 10/100 Base-T module (internal)	400.00
98057	Ethernet TCP/IP, wireless LAN card 802.11 B/G	650.00
87803	Ethernet IP (specifically for A-B PLC)	800.00
68539	Allen-Bradley Remote I/O interface (limited supply)	650.00
68540	Profibus® DP interface	650.00
68541	DeviceNet™ interface	650.00
103136	ControlNet interface	1,000.00
<b>Expansion Cards</b>		
69782	Two-slot expansion board (wall mount)	260.00
71743	Two-slot expansion board (panel mount & deep universal)	260.00
69783	Six-slot expansion board (wall mount)	385.00
<b>Hardware</b>		
154077	Scanner, DS457-SR, RS-232, requires power source	600.00
83569	Clear protective overlay (package of five)	65.00
70056	Cable, DB9M to DB9F, Straight Cable	35.00
93359	PS/2 Keyboard	45.00
77788	Fiber optic board, installed in 920i	200.00
92777	Filter, PreVent™ vent kit PG 7 cord grip	25.00
19368	Start/stop controls without box, for use on wall mount	300.00
19369	Start/stop switch with FRP box	300.00
100759	Sunlight viewable display, transreflective installed option, replaces transmissive display	275.00
<b>Manuals and Software</b>		
69781	iRev™ Scale Software	95.00
72809	920i interchange® database software	295.00
67887	Additional installation manual	30.00
67888	Additional programming reference	30.00
<b>Primary Component Parts</b>		
117930	CPU board assembly	875.00
164371	Display board assembly Transmission Blue	265.00
164375	Display board assembly, Transflective Gray, sunlight viewable	265.00
67613	Power supply assembly, 25 watt	135.00
71333	Power supply, 65 watt used in Deep, Panel Mount and Wall Enclosures	165.00
97474	DC/DC converter 9-36 nominal, 25 watt	160.00
66502	Switch panel membrane	68.00

## Grayhill Relays and Racks

PART #	DESCRIPTION	PRICE
52332	2-channel input relay, 2.5-28VDC	\$45.00
52318	2-channel input relay, 120VAC	45.00
52319	2-channel input relay, 240VAC	45.00
52331	2-channel input relay, 10-32VDC	45.00
52316	2-channel output relay, 120-140VAC at 2 amp	45.00
52317	2-channel output relay, 240-280VAC at 7 amp	45.00
71376	2-channel output relay, 3-60VDC at 1 amp	65.00
71377	2-channel output relay, 0-200VDC/VAC at 1.5A/10W (dry contact)	85.00
84698	2-channel output relay, inductive load, 120-140VAC at 2A	65.00
84699	2-channel output relay, inductive load, 240-280VAC at 2A	65.00
52312	8-channel relay rack, panel mount and wall mount, requires 50-Pin flat or round ribbon cable - 4 slots	135.00
52314	16-channel relay rack, panel mount and wall mount, requires 50-Pin flat or round ribbon cable - 8 slots	185.00
52315	24-channel relay rack, panel mount and wall mount, requires 50-Pin flat or round ribbon cable - 12 slots	285.00
76644	8-channel relay rack, DIN rail mount, requires 50-Pin flat or round ribbon cable - 4 slots	155.00
76645	16-channel relay rack, DIN rail mount, requires 50-Pin flat or round ribbon cable - 8 slots	235.00
76646	24-channel relay rack, DIN rail mount requires 50-Pin flat or round ribbon cable - 12 slots	525.00
46189	Jumper strap, 10 position for Grayhill	5.00
108396	Digital input 5VDC, 15-30 VAC/10-32VDC	35.00
108397	Digital output 5VDC, 3-60VDC	35.00
70780	Cable, 50-Pin flat ribbon for digital I/O	50.00
70779	Cable, 50-Pin round ribbon for digital I/O with cord grip	150.00
72442	Cable, 50-Pin round ribbon for digital I/O without cord grip	145.00

## OPTO 22 Relays and Racks

PART #	DESCRIPTION	PRICE
15969	G4IDC5 10-32VDC Input relay module, white (N/O)	\$30.00
15970	G40DC5R Dry contact 100VDC/1.5A output, red (N/O)	35.00
22848	G40DC5R5 Dry contact 100VDC/1.5A output, red (N/C)	35.00
15971	G40AC5 115VAC Output relay module, black (N/O)	35.00
15972	G4IAC5 115VAC Input relay module, yellow (N/O)	35.00
22847	G40AC5A5 115/230VAC Output relay module, black (N/C)	35.00
36632	G40AC5A 115/230VAC Output relay module, black (N/O)	35.00
36631	G4IAC5A 230VAC Input relay module, yellow (N/O)	30.00
16478	Quencharc arc suppressor	11.00
101923	FRP Enclosure with Opto 4-channel rack	235.00
15973	4-channel relay rack, 3.25 x 3.25 in	100.00
45408	4-channel relay rack 6.1 x 1.2 in	150.00
99032	Adapter plate, for 4-channel Opto rack 33490	5.00
54215	Fuse, 3.15 amp, Grayhill	3.00
26834	Fuse, 1 amp, OPTO 22	7.50
21735	Fuse, 4 amp, OPTO 22	5.00

# 920i® USB

Programmable HMI Indicator/Controller

## Specifications

### Power:

Line voltages: 115 or 230VAC  
 Frequency: 50 or 60 Hz  
 Power consumption: 340 mA, maximum at 115VAC (26W) 240 mA at 230VAC (26W)

### Excitation Voltage:

10 ± VDC, 16 x 350 Ω or 32 x 700 Ω load cells per A/D card

### Analog Signal Input Range:

-10 mV to +45 mV

### Analog Signal Sensitivity:

0.3 μV/graduation minimum at 7.5 Hz  
 1.0 μV/graduation typical at 120 Hz  
 4.0 μV/graduation typical at 960 Hz

### A/D Sample Rate:

7.5 to 960 Hz, software selectable

### Resolution:

Internal resolution: 8 million counts  
 Weight display resolution: 9,999,999

### System Linearity:

± 0.01% full scale

### Digital I/O:

Six I/O channels on CPU board; optional 24-channel I/O expansion boards available

### Circuit Protection:

RFI, EMI, ESD protection

### Serial Ports:

Four ports on CPU board support up to 115,200 bps; optional dual-channel serial expansion boards available  
 Port 1: Full duplex RS-232  
 Port 2: USB Type A and Type B connectors  
 Port 3: Full duplex RS-232, 20 mA output  
 Port 4: Full duplex RS-232, 2-wire RS-485, 20 mA output

### Display (W x H):

4.6 x 3.4 in (116 W x 86 mm H), 320 x 240 pixel VGA Liquid Crystal Display (LCD) module with adjustable contrast.  
 Transmissive display - standard  
 Transflective display - option

### Keyboard:

27-key membrane panel, tactile feel

### Operating Temperature:

Legal: 14°F to 104°F (-10°C to +40°C)  
 Industrial: 14°F to 122°F (-10°C to +50°C)

### Weight:

Universal enclosure: 9.5 lb (4.3 kg)  
 Wall Mount enclosure: 23.0 lb (10.4 kg)  
 Panel Mount enclosure: 8.5 lb (3.9 kg)  
 Deep Universal: 11 lb (5.0 kg)

### Rating/Material:

NEMA 4X/IP66, stainless steel

### Warranty:

Two-year limited warranty

### Approvals:

NTEP CC 01-088, Class III/IIIL 10,000d  
 Measurement Canada AM-5426, Class III/III HD 10,000d  
 OIML UK 2658, 6,000/10,000  
 CE marked  
 UL & C-UL listed (Universal, Deep and Wall Mount Enclosure)  
 Custom Wall Mount approved for 508A (Optional)  
 Panel Mount UL recognized



## APPROVALS



Measurement  
Canada  
Approved



## Standard Features

- The 920i USB shares the same hardware as the 920i
- USB interface card on Port 2
- The USB card is supported on Rev L CPU boards or later
- The 920i for USB interface requires firmware version 5.0 or higher

### Connector Types:

- Standard Type A: 920i connects to keyboard, printers\* and flash drives
- Standard Type B: 920i connects to PC

### USB Interface Functions:

- Supports weigh mode and configuration mode functions
- Supports upload of databases and .920 configuration file
- Supports download of databases, .920 configuration file, iRite, COD file, and firmware file
- Sanity checks for command errors

### Flash Drives:

- Supports USB 2.0
- Create sub directories by unit ID and database name
- Use the root directory for generic files

### Optional Washdown Connectors (see below)

- Sealed receptacle
- Connectors - cables
- USB cover - flash drive and receptacle

\* ASCII font label and ticket printers

# 920i® USB

Programmable HMI Indicator/Controller

## Part Number/Price

PART #	DESCRIPTION	EST. SHIP WEIGHT	PRICE
<b>Single Channel - 115 VAC †</b>			
115003	920i Universal	10 lb	\$2,000.00
115004	920i Deep Universal	12 lb	2,200.00
115005	920i Wall Mount, stainless steel	23 lb	2,600.00
115006	920i Panel Mount, stainless steel bezel	9 lb	2,000.00
<b>Single Channel - 230 VAC †</b>			
120062	920i Universal	10 lb	2,000.00
120064	920i Deep Universal	12 lb	2,200.00
120066	920i Wall Mount	23 lb	2,600.00
120069	920i Panel Mount	9 lb	2,000.00
<b>Single Channel - 230 VAC with Euro plug ††</b>			
120074	920i Universal	10 lb	2,000.00
120075	920i Deep Universal	12 lb	2,200.00
120078	920i Wall Mount	23 lb	2,600.00
120079	920i Panel Mount	9 lb	2,000.00
<b>Single Channel - 9-36 VDC</b>			
120080	920i Universal, 25 watt	10 lb	2,100.00
120081	920i Deep Universal, 25 watt	12 lb	2,300.00
120082	920i Wall Mount, 25 watt	23 lb	2,700.00
120083	920i Panel Mount, 25 watt	9 lb	2,100.00
<b>Dual Channel - 115 VAC †</b>			
120086	920i Universal	10 lb	2,100.00
120087	920i Deep Universal	12 lb	2,300.00
120088	920i Wall Mount	23 lb	2,700.00
120089	920i Panel Mount	9 lb	2,100.00
<b>Dual Channel - 230 VAC †</b>			
120090	920i Universal	10 lb	2,100.00
120092	920i Deep Universal	12 lb	2,300.00
120093	920i Wall Mount	23 lb	2,700.00
120095	920i Panel Mount	9 lb	2,100.00
<b>Dual Channel - 230 VAC with Euro plug ††</b>			
120096	920i Universal	10 lb	2,100.00
120097	920i Deep Universal	12 lb	2,300.00
120098	920i Wall Mount	23 lb	2,700.00
120099	920i Panel Mount	9 lb	2,100.00
<b>No A-D Channel - 115 VAC †</b>			
120100	920i Universal, without A/D channel	10 lb	1,850.00
120101	920i Deep Universal, without A/D channel	12 lb	2,050.00
120102	920i Wall Mount, without A/D channel	23 lb	2,450.00
120103	920i Panel Mount, without A/D channel	9 lb	1,850.00
<b>No A-D Channel - 230 VAC with Euro plug ††</b>			
120104	920i Universal, without A/D channel	10 lb	1,850.00
120105	920i Deep Universal, without A/D channel	12 lb	2,050.00
120106	920i Wall Mount, without A/D channel	23 lb	2,450.00
120107	920i Panel Mount, without A/D channel	9 lb	1,850.00

## Options/Accessories

PART #	DESCRIPTION	CONNECTOR TYPE				PRICE
		Sealed		Unsealed		
USB Options						
Note: connector is a male plug, receptacle is a socket						
		A	B	A	B	
79074	Cable, unsealed connectors USB-A to USB-B, 6 feet			X	X	\$30.00
126478	IP68 Cable with sealed connectors, USB-A to USB-A, 3 meters	X	X			55.00
124700	IP68 Cable with sealed connectors, USB-A to USB-B, 3 meters	X	X			55.00
126477	IP68 Cable with USB-A sealed connector, unsealed USB-A connector	X		X		55.00
124701	IP68 Cable with USB-A sealed connector, unsealed USB-B connector, 3 meters	X			X	55.00
124702	IP68 Cable with USB-B sealed connector, unsealed USB-A connector, 3 meters		X	X		55.00
126476	Receptacle USB-A sealed to unsealed USB-A connector, 0.5 meter	X		X		55.00
124703	Receptacle USB-A sealed to unsealed USB-B connector, 0.5 meter	X			X	55.00
124704	Receptacle USB-B sealed to unsealed USB-B connector, 0.5 meter		X		X	55.00
125998*	Receptacle USB-A sealed to 5 Pin connector, 0.28 meter (internal to 920i)	X				55.00
125999*	Receptacle USB-B sealed to 5 Pin Connector, 0.28 meter (internal to 920i)	X				55.00
124694	Cover for sealed receptacles					5.00
124689	Cover for flash driver mounts on sealed receptacle					15.00
124695	Panel Plug 1.125 in diameter					5.00
125077	Rice Lake USB flash drive, 1 GB					20.00
111109	USB Interface Card					160.00
99149	Keyboard, QWERTY 109-key USB, flexible, washable					135.00

Ethernet Options		Sealed	Unsealed	
126353*	Ethernet RJ-45 receptacle sealed, 0.28 meter internal to 920i (Requires Ethernet TCP/IP option installed)	X		75.00
124706	Ethernet cable with sealed connectors, 3 meters	X		70.00
124707	Ethernet cable sealed connector to unsealed connector, 3 meters	X	X	70.00

\*These options require a milled back plate which has two cutouts. If ordering only one receptacle, a plug (PN 124695) is required for the second cutout. USB enclosure parts with cutout: Part Numbers; Universal 119891, Universal Deep 115118, Wall Mount 126585



†† CEE 7/7 plug



† NEMA 5-15 plug

# 920i® User Programs

## Standard Features

- Pre-programmed software to carry out specific weighing functions
- Utilize Rice Lake's iRite™ programming language
- For use with all Rice Lake 920i models (hardware requirements may apply)
- Available pre-installed with purchase of new equipment, or via iRev™ for installation on existing 920i models.
- Fully customizable

### Dual Kiosk Truck In/Out Single Scale PN 156959:

System consists of a bidirectional single platform truck scale, an inbound truck kiosk, and an outbound truck kiosk. Inbound (if 2 outbound kiosks are used) and outbound tickets with transaction storage of each weighment.

#### Suggested Hardware:

- (2) PN 119687 Inbound/Outbound kiosk
- PN 119689 A/D kiosk option

### Grain Program with Shrink Calculator PN 156886:

This custom application for the 920i supports weighing trucks of grain. Up to 200-grain types, associated divisors and accumulator can be stored. Up to 500 accounts and 1000 trucks can be stored.

#### Suggested Hardware:

- PN 67527 920 single channel A/D
- PN 67600 1Meg memory card
- PN 23113 Epson TM-U295 ticket printer
- PN 93359 PS2 keyboard.

### Truck In/Out with Products/Customers/Trucks and Reports PN 77297:

This program supports truck in/out weighing program for manual truck transactions using Rice Lake Weighing Systems' 920i digital weight indicator. Stored IDs let you keep a database of truck IDs, customer, product, project information, and weigh-in weights in the indicator's memory. Parameters are accessed by simply scrolling through the Supervisor main menu using the down arrow on the 920i. The 920i can automatically store up to 100 truck ID's and tare weights, 950 customers, 1000 products, and 1000 projects.

#### Suggested Hardware:

- PN 67527 920 single channel A/D
- PN 67600 1Meg memory card
- PN 23113 Epson TM-U295 ticket printer
- PN 93359 PS2 keyboard



### Short Axle Weighing Program PN 153146:

920i custom program will interface to a short axle scale and will direct each axle across the scale using traffic lights.

#### Suggested Hardware:

- PN 67527 920 single channel A/D
- PN 23113 Epson TM-U295 ticket printer
- PN 101923 FRP box with 4 channel relay rack, for traffic light control
- PN 23146 Traffic-light kit
- PN 15971 AC output relays for above (2 needed)
- PN 103181 LaserLight remote display (optional)

### Truck In/Out with Report PN SZ99999:

920i program allows trucks to weigh in and out (saves inbound weight after weighing out and has value swapping) and stores the transaction after each weigh out with Truck ID, Gross, Tare, Net. Transactions may be printed or cleared at any time through the Setup Menu. An HID scanner is available as a peripheral piece of hardware.

#### Suggested Hardware:

- PN 119687 Outbound kiosk
- PN 119689 A/D kiosk option
- PN 119743 HID kiosk option

## Part Number/Price

PART #	DESCRIPTION	PRICE
153146	Short axle weighing program	\$595.00
SZ99999	Truck In/Out with report	395.00
77297	Truck In/Out with products/customers/trucks and reports	495.00
156886	Grain program with shrink calculation	395.00
156959	Dual kiosk truck In/Out single scale	595.00



# 920i® FlexWeigh Systems

Fillers/Batchers

## Standard Features

- Wallmount stainless steel enclosure
- Application program 101, 102, 103, 104, 201, 202
- Front panel switches E-Stop, Reset/Resume, Start
- Softkeys for presets, CN#, ID#, formula#, totals
- Accumulating subtotal & total registers
- Transmitted audit trail
- Digital I/O Board
- Relay rack and SSR relay outputs



**Manufacturer-Approved**  
DIRECT REPLACEMENT FOR FLEXWEIGH'S DWM-IV

## APPROVALS



## Specifications

STANDARD SWITCHES	101/103/104	102	201	202
E-Stop mushroom	X	X	X	X
Reset/Resume	X	X	X	X
Start	X	X	X	X
Discharge	-	X	-	X

OUTPUTS	101	102	103	104	201	202
Fast fill**	X	X	X	X	X	X
Slow fill***	X	X	X	X	X	X
Fill complete*	Opt	Opt	X	X	Opt	Opt
Zero tolerance	Opt	Opt	-	-	Opt	Opt
Discharge	-	X	-	-	-	X
Refill	-	-	X	-	-	-
Refill complete	-	-	Opt	-	-	-
Slow cycle	-	-	Opt	X	-	-

\* Dispense for 103 and 104

\*\* Fast Fill Ingredient 1 201/202

\*\*\* Fast Fill Ingredient 2 201/202

### 101 Basic Filler

Place an empty container on the scale. Automatically fill the container to a preset weight. Remove the container from the scale. Replace it on the scale with an empty and repeat the process.

### 102 Automatic Fill, Automatic Discharge

Place an empty container under the scale. Automatically fill the scale to a preset weight. Discharge the scale into the container. Remove the container from under the scale. Replace it under the scale with another empty container and repeat the process.

### 103 Loss-In-Weight Filler

Dispense preset net weight quantities from the scale until either low level or less-than-preset gross weight is achieved. Then refill to high level.

### 104 Loss-In-Weight Filler

Product supply containers are placed on the scale. Net weight quantities are dispensed from the containers until empty. When containers empty in the middle of a dispense cycle, the cycle is paused and allowed to resume where it left off when the empty containers are replaced on the scale with filled ones.

### 201 Four Ingredient Dual Speed or Eight Ingredient Single Speed Batcher

Place empty container on scale, automatically fill multiple ingredients in a sequential order to preset formula weights. Remove the container, replace with empty and repeat

### 202 Four Ingredient Dual Speed or Eight Ingredient Single Speed With Discharge

Fill tank or hopper with multiple ingredients in a sequential order then empty into a vessel below.

# 920i® FlexWeigh Systems

Fillers/Batchers

INDICATORS / CONTROLLERS

## Part Number/Price

PART #	DESCRIPTION	EST. SHIP WEIGHT	PRICE
120320	920i FlexWeigh Systems 101	23 lb	\$3,200.00
120321	920i FlexWeigh Systems 102	23 lb	3,300.00
120322	920i FlexWeigh Systems 103	23 lb	3,250.00
120323	920i FlexWeigh Systems 104	23 lb	3,200.00
—	920i FlexWeigh Systems 201	23 lb	3,300.00
—	920i FlexWeigh Systems 202	23 lb	3,500.00
<b>Relays</b>			
52312	8-channel relay rack (4 slots)		135.00
52316	2-channel output relay, 120 - 140 VAC at 2A		45.00
52317	2-channel output relay, 240-280 VAC at 2A		45.00

## Options/Accessories

PART #	DESCRIPTION	PRICE
120491	920i FlexWeigh Systems 101 manual	\$25.00
120493	920i FlexWeigh Systems 102 manual	25.00
124473	920i FlexWeigh Systems 103 manual	25.00
120496	920i FlexWeigh Systems 104 manual	25.00
152146	920i FlexWeigh Systems 201/202 manual	25.00

## Optional Switches

Installed price \$150.00

SWITCH PART #		LEGEND PART #	101	102	103/104	201	202
Selector 3 position	94296						
Manual / Off / Auto		121035	X	X	X	X	X
Manual Ingredient Select						X	X
Push-button	94276						
Fill		121036	X	X		X	X
Discharge		121037		X			X
Dispense		121038			X		
Refill		121039			X		
Maintained/Off/Spring Return	94299						
Fill On/-/Jog		121040	X	X		X	X
Fill Fast-/Slow		121041	X	X		X	X
Discharge On/-/Jog		121043		X			X
Discharge Fast-/Slow		121044		X			X
Dispense On/-/Jog		121046			X		
Dispense Fast-/Slow		121048			X		
Refill On/-/Jog		121049			X		
Manual Feed		—				X	X

## Optional Front Panel Lights

Installed price \$150.00

LAMP		LEGEND	101/102	103	104		
Ready	94289 Green	121051	X			X	X
Fill Complete	94290 Red	121052	X			X	X
Filling	98760 Amber	121053	X				
Filling Fast	98760 Amber	121054	X				
Filling Slow	98760 Amber	121055	X				
Discharging	94292 Blue	121056	X			X	X
Discharging Fast	94292 Blue	121057	X				
Discharging Slow	94292 Blue	121058	X				
Dispensing	98760 Amber	121059		X	X		
Dispensing Fast	98760 Amber	121060		X	X		
Dispensing Slow	98760 Amber	121061		X	X		
Dispensing Complete	94290 Red	121062		X	X		
Refilling	94292 Blue	121063		X			
Refill Complete	94290 Red	121064		X			
Low Supply	94290 Red	121065		X	X		
Fill Time Alarm	94290 Red	121066		X	X		
Feeding (1-4)	98760 Amber	—				X	X

www.ricelake.com | Phone: 800-472-6703

RICE LAKE

# 920i® FlexWeigh Systems

Bulkweighers

## Standard Features

- Wall mount stainless steel enclosure
- Application program 107,108,109
- Front panel switches E-Stop, Start/Resume, End Cycle, Ship/Recv (only 109)
- Softkeys for presets, ID1 and ID2
- Accumulating weight streaming
- Fill and discharge sequence controls
- Fill and discharge gate monitoring
- Printer online checking
- Weigh and surge hopper overflow monitoring
- Transmitted audit trail
- Digital I/O Board
- Relay rack and SSR relay outputs

## Options

- Pilot lights for error indication
- Manual override switches

### 107 Shipping Bulkweigher

The 920i FlexWeigh 107 is designed for basic shipping-mode bulkweighing applications. In shipping mode, a scale is loaded and discharged repetitively until the accumulated weight meets the overall target value.

### 108 Receiving Bulkweigher

The 920i FlexWeigh 108 is designed for basic receiving mode bulkweighing applications. In receiving mode, a scale is loaded and discharged until there is no more product to receive. To end the cycle the End Cycle button is pressed.

### 109 Ship/Receive Bulkweigher

The 920i FlexWeigh 109 allows the user to select which mode of operation to use. This is done with a three-position locking key switch.



**Manufacturer-Approved**  
DIRECT REPLACEMENT FOR FLEXWEIGH'S DWM-IV

## APPROVALS



## Specifications

STANDARD SWITCHES	107	108	109
E-Stop mushroom	X	X	X
Start/resume	X	X	X
End Cycle	X	X	X
Ship/Recv	-	-	X

OUTPUTS	107	108	109
Fill Gate closed*	X	X	X
Discharge Gate closed*	X	X	X
Surge hopper not full*	X	X	X
Weigh hopper not full*	X	X	X
Printer online*	X	X	X
Slow cycle alarm	OPT	OPT	OPT
Gate alarm	OPT	OPT	OPT
Scale over fill alarm	OPT	OPT	OPT
Lower surge alarm	OPT	OPT	OPT
Printer alarm	OPT	OPT	OPT
Open fill gate	X	X	X
Open discharge gate	X	X	X

\* Denotes input

# 920i® FlexWeigh Systems

Bulkweighers

INDICATORS / CONTROLLERS

## Part Number/Price

PART #	DESCRIPTION	EST. SHIP WEIGHT	PRICE
Consult	920i FlexWeigh Systems 107	23 lb	\$4,700.00
Consult	920i FlexWeigh Systems 108	23 lb	4,700.00
Consult	920i FlexWeigh Systems 109	23 lb	5,000.00

## Options/Accessories

PART #	DESCRIPTION	PRICE
151848	920i FlexWeigh Systems 107/108/109 manual	\$25.00

## Optional Switches

**Installed price \$150.00**

TYPE		107	108	109
Manual / Off / Auto	3 position key selector	X	X	X
Man Fill	On/-/Jog		X	X
Man Disch	On/-/Jog		X	X
	Maintained/Off/Spring Return			

## Optional Front Panel Lights

**Installed price \$150.00**

LAMP			101/102	103	104
Slow Cycle	94290	Red	X	X	X
Gate Fault	94290	Red	X	X	X
Scale Overfill	94290	Red	X	X	X
Surge Backup	94290	Red	X	X	X
Printer	94290	Red	X	X	X

www.ricelake.com | Phone: 800-472-6703

**RICELAKE**

# 920i® FlexWeigh Systems

## Flow Rate Controllers

### Standard Features

- Wall mount stainless steel enclosure
- Application program 105, 106, 205
- Front panel switches E-Stop, Reset/Resume, Start
- Softkeys for presets, CN#, ID#, formula#, totals
- Accumulating subtotal & total registers
- Transmitted audit trail
- Digital I/O Board
- Relay rack and SSR relay outputs

#### 105 Basic Flow-Rate Controller

Dispense preset net weight quantities at preset flow rate values.

#### 106 Loss-In-Weight with Flow-Rate Control and Automatic Refill

Dispense preset net weigh quantities at preset flow rate values with automatic refill when gross weight drops below threshold.

#### 205 Eight Ingredient Batcher with Flow-Rate Control Discharge

Batch up to eight ingredients in sequential order to preset formula weights. Discharge to net quantities via preset flow- rate control.



**Manufacturer-Approved**  
DIRECT REPLACEMENT FOR FLEXWEIGH'S DWM-IV

### APPROVALS



### Specifications

STANDARD SWITCHES	105	106	205
E-Stop mushroom	X	X	X
Reset/resume	X	X	X
Start	X	X	X
Discharge	-	-	X

OUTPUTS	105	106	205
Fast fill**	X	-	X
Slow fill***	X	-	X
Fill complete*	X	-	X
Zero tolerance	Opt	-	Opt
Discharge	X	X	X
Refill	-	X	-
Refill complete	-	Opt	--
Slow cycle	Opt	Opt	Opt

\* Dispense for 105 and 106

\*\* Fast Fill Ingredient 1 205

\*\*\* Fast Fill Ingredient 2 205

# 920i® FlexWeigh Systems

Flow Rate Controllers

INDICATORS / CONTROLLERS

## Part Number/Price

PART #	DESCRIPTION	EST. SHIP WEIGHT	PRICE
Consult	920i FlexWeigh Systems 105	23 lb	\$3,500.00
Consult	920i FlexWeigh Systems 106	23 lb	3,500.00
Consult	920i FlexWeigh Systems 205	23 lb	3,750.00
<b>Relays</b>			
52312	8-channel relay rack (4 slots)		135.00
52316	2-channel output relay, 120 - 140 VAC at 2A		45.00
52317	2-channel output relay, 240-280 VAC at 2A		45.00

## Options/Accessories

PART #	DESCRIPTION	PRICE
Consult	920i FlexWeigh Systems 105 manual	\$25.00
Consult	920i FlexWeigh Systems 106 manual	25.00
Consult	920i FlexWeigh Systems 205 manual	25.00

www.ricelake.com | Phone: 800-472-6703

**RICE LAKE**

# 920i® FlexWeigh Systems

Hand Batching

## Standard Features

- Stainless deep universal mount enclosure
- Application program 211
- Soft keys for presets ID#, Formulas, Totals Accumulating Subtotal and Total Registers
- Switch for manual confirmation
- 20 ingredient database
- 100 formula database
- Audit trail data output
- Ingredient usage totals

## 211 Manual Batching System

Prompts the user through manual weight additions based on a pre-entered formula



**Manufacturer-Approved**  
DIRECT REPLACEMENT FOR FLEXWEIGH'S DWM-IV

## APPROVALS



## Part Number/Price

PART #	DESCRIPTION	EST. SHIP WEIGHT	PRICE
Consult	920i Flexweigh Systems 211	13 lb	\$2,250.00

# MSI-8000HD

## Digital Weight Indicator

### Specifications

**Enclosure:**

NEMA 4, IP68 milled anodized aluminum with O-ring gaskets

**Keypad:**

On/Off, Zero (100%), Tare, Print, and Two user-defined keys for the following functions: peak hold, high resolution, total, view total, net/gross, units switching

**Display:**

Six-digit 1.0 in (26.4 mm) LCD

**Units Displayed:**

Pounds, kilograms, tons, metric tons, kilonewtons

**Annunciators:**

Stable, COZ, peak, M, kg, kN, lb, ton, setpoint, function LEDs. Channels: 1, 2, 3, 4, TTL

**Power:**

90-247VAC, 9-36VDC, 18-72VDC, 120-300VDC

**Operating Temperature:**

-4°F to 140°F (-20°C to 60°C)

**RF Remote Channels:**

Up to four remote sensors, monitored individually, in pairs, or sum all (non-A/D version only)

**Service Counters**

A/D version only

**A/D Inputs:**

Two independent or summing load cell inputs

**Excitation:**

4.8V current limited and over-voltage protected

**Filtering:**

Off, Low, Hi-1, Hi-2

**RF Radio Link:**

2.4 GHz 802.15.4

**RF Effective Range:**

Typically 100 or more feet (33 m)

**Data I/O:**

Dual RS-232 comm ports

**Warranty:**

One-year limited

**Approvals:**

Pending



### Standard Features

- Indicator or Handheld RF remote display with six-digit 1.0 in (26.4 mm) LCD screen
- IP68 rugged milled aluminum enclosure
- Membrane keypad for remote control functionality
- User definable function keys for added versatility

### Part Number/Price

PART #	DESCRIPTION	EST. SHIP WEIGHT	PRICE
158425	MSI-8000HD RF digital weight indicator, two A/D inputs, FHSS RF out, AC powered	5 lb	1,480.00
158426	MSI-8000HD digital weight indicator, two A/D inputs, FHSS RF out, battery powered	5 lb	1,580.00

### Options/Accessories

PART #	DESCRIPTION	PRICE
155173	MSI-8000HD tilt stand option kit	\$61.00
155193	MSI-8000HD Ethernet TCP/IP option kit	360.00
155269	MSI-8000HD serial RS-232 cable	95.00
158779	MSI-8000HD coil relay option kit, 250 VAC/30 VDC 5A or 100 VDC 0.4A	Consult
158780	MSI-8000HD solid state relay option kit, 60 Vpk 2.7A	Consult
158781	MSI-8000HD solid state relay option kit, 200 Vpk 0.9A	Consult
149549	Universal 115/230 VAC 50/60 Hz (NA plug standard) battery charger for MSI-8000HD battery powered device	120.00



# CW-90

Checkweigher Indicator Only

## Specifications

### Power - AC:

Line voltages: 115/230VAC  
Frequency: 50/60Hz

### Power Consumption:

1.5A at 115VAC (8W),  
0.75A at 230VAC (8W)

### Excitation Voltage:

+5VDC 8 x 350Ω or  
16 x 700Ω load cells

### Analog Signal Input Range:

-0.5mV/V - 4.5mV/V

### Analog Signal Sensitivity:

0.3uV/graduation minimum, 1.5uV/ graduation recommended

### Measurement Rate:

960,480, 240, 120, 60, 30, 15, 7.5 per second

### System Linearity:

+/- 0.01% full scale

### Circuit Protection:

RFI, EMI, ESD protection

### Digital I/O:

4 channels on CPU board

### Display:

Large 0.8 in 14 segment, 6 digit high-intensity red LED display

### Status Annunciators:

Designators for %, kg, gm, lb, oz, center of zero, G/B, N, T, PT, neg, motion

### Operating Temperature:

Legal: 14°F to 104°F (-10°C to 40°C)

### Rating/Material:

IP66, stainless steel

### Keyboard:

Membrane keypad, 23 keys with International symbols

### Display Resolution:

100,000 graduations maximum

### Warranty:

Two-year limited warranty

### Approvals:

NTEP CC 08-092  
Measurement Canada AM-5710  
OIML R76/2006-GBI-10.02  
TC GB-1385  
TAC UK2900  
UL & CUL listed  
CE marked



## APPROVALS



Measurement  
Canada  
Approved



## Standard Features

- Membrane keypad consisting of ZERO, UNITS, PRINT, TARE, OVER, UNDER, ID, TARGET, 0-9, CLEAR, DECIMAL, ENTER, MENU, POWER
- 304 stainless steel, IP66 rated
- PreVent breather vent
- Storage for up to 50 IDs
- Unit of measure: kg, gm, lb, oz, lb/oz
- High intensity LED display
- Time and date
- Two full duplex serial ports
- Configurable print formats
- Audit trail tracking
- Optional communications: Ethernet, USB or Fiber Optic
- Four configurable digital I/O
- Reflash memory to upgrade firmware

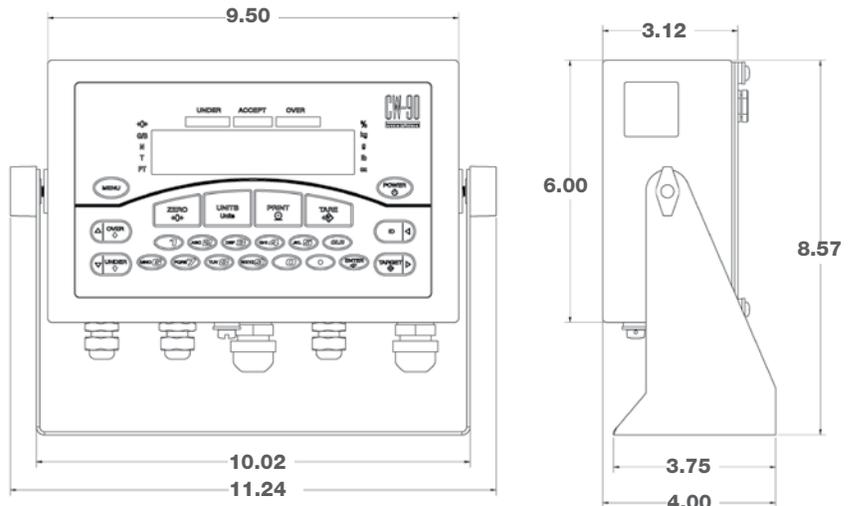

# CW-90

Checkweigher Indicator Only

## Part Number/Price

PART #	DESCRIPTION	EST. SHIP WEIGHT	PRICE
105970†	CW-90, 115VAC	7 lb	\$775.00
105971††	CW-90, 230VAC, CE marked/OIML approved	7 lb	775.00
118888†	CW-90, 230VAC	7 lb	775.00

## Options/Accessories

PART #	DESCRIPTION	PRICE
77142	Ethernet TCP/IP	\$400.00
108671	Wireless LAN card WiFi 802.11 A/B	570.00
93245	USB Port (PC connection only)	160.00
95357	USB cable, Type A to mini-B, 1 meter	5.00
96736	Fiber optic board	200.00
78026	Fiber optic, duplex cable 100 ft	135.00
80892	Fiber optic cutter	9.00
117358	WeighVault™ (requires part number 77142 or 108671)	200.00



† NEMA 5-15 plug



†† CEE 7/7 plug

# CW-90X

Checkweigher Indicator Only

## Specifications

### Power - AC:

Line voltages: 115/230VAC  
Frequency: 50/60 Hz

### Power Consumption:

1.5A at 115VAC (8W),  
0.75A at 230VAC (8W)

### Excitation Voltage:

+5VDC 8 x 350 Ω or  
16 x 700 Ω load cells

### Analog Signal Input Range:

-0.5 mV/V - 4.5 mV/V

### Analog Signal Sensitivity:

0.3 uV/graduation minimum, 1.5 uV/ graduation recommended

### Measurement Rate:

960, 480, 240, 120, 60, 30, 15, 7.5 per second

### System Linearity:

+/- 0.01% full scale

### Digital I/O:

4 channels on CPU board

### Circuit Protection:

RFI, EMI, ESD protection

### Display:

Large 0.8 in 14 segment, 6 digit high-intensity red LED display

### Status Annunciators:

Designators for %, kg, gm, lb, oz, center of zero, G/B, N, T, PT, neg, motion

### Operating Temperature:

Legal: 14°F to 104°F (-10°C to 40°C)

### Rating/Material:

IP69K, stainless steel

### Display Resolution:

100,000 graduations maximum

### Keyboard:

Piezo keypad, 11 keys with International symbols

### Warranty:

Three-year limited warranty

### Approvals:

NTEP CC 08-092, Class III/IIIL 10,000d  
Measurement Canada AM-5710  
OIML R76/2006-GBI-10.02  
TC GB-1385  
TAC UK2900  
UL & CUL listed  
CE marked



## APPROVALS



Measurement  
Canada  
Approved



## Standard Features

- Piezo keypad consisting of ZERO, UNITS PRINT, TARE, UNDER, ID, TARGET, ENTER, MENU, POWER
- 304 stainless steel, IP69K rated
- PreVent™ breather vent
- Storage for up to 50 IDs
- Unit of measure: kg, gm, lb, oz, lb/oz
- High intensity LED display
- Battery backed time and date
- Two full duplex serial ports
- Configurable print formats
- Audit trail tracking and alibi storage
- Optional communications: Ethernet, USB or Fiber Optic
- Four configurable digital I/O
- Reflash memory to upgrade firmware

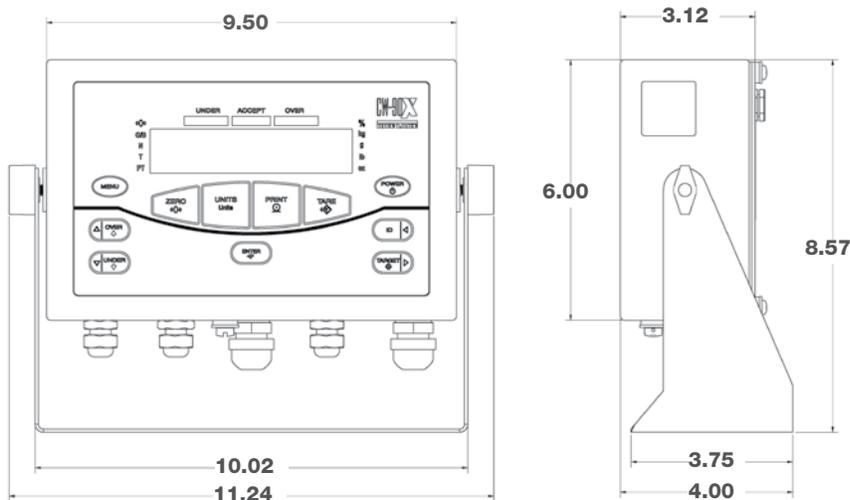

# CW-90X

Checkweigher Indicator Only

## Part Number/Price

PART #	DESCRIPTION	EST. SHIP WEIGHT	PRICE
105972†	CW-90X, 115VAC	7 lb	\$820.00
105973††	CW-90X, 230VAC, CE marked/OIML approved	7 lb	820.00
118889†	CW-90X, 230VAC	7 lb	820.00

## Options/Accessories

PART #	DESCRIPTION	PRICE
77142	Ethernet TCP/IP	\$400.00
108671	Wireless LAN card WiFi 802.11 A/B	570.00
93245	USB Port (PC connection only)	160.00
95357	USB cable, Type A to mini-B, 1 meter	5.00
96736	Fiber optic board	200.00
78026	Fiber optic, duplex cable 100 ft	135.00
80892	Fiber optic cutter	9.00
117358	WeighVault™ (requires part number 77142 or 108671)	200.00



† NEMA 5-15 plug



†† CEE 7/7 plug

# VIRTUi2®

PC-Based HMI for iQUBE2®

VIRTUi2 is a Windows®-based desktop application that works with iQUBE2 to replicate simple indicator functionality ideal for system integrators and OEMs wanting to provide a PC-based solution. Load cells are individually monitored and calibrated, making setup easy.

## Specifications

### Minimum System Requirements:

- Windows® XP™ or greater
- Internet Explorer 6.0 SP1
- .NET Framework 1.1
- 128 MB Ram
- 30 MB free hard drive space
- Serial port for connection to iQUBE
- Additional serial ports are required for connections to printers/remote displays

### Status Annunciators:

Units (lb, kg, short tons (tn), metric tons (t), NONE) Gross/Net, Motion, Center of Zero

### Approvals:

NTEP CC 04-058 Classes III and IIII at 10,000d

## Standard Features (virtui2)

- Web browser-based iQUBE® cell status
- Configurable display options
- Up to four scale systems and one total scale
- Virtual front panel consists of display and five button keypad
- Up to four digital I/O (provided by iQUBE2)
- Primary/secondary units configuration (lb, kg, short tons, metric tons, none)
- RS-232 communications at up to 460 Kbps
- Electronic Data Processing (EDP) port over RS-232 and TCP/IP
- Printer port for output-only, simplex communications
- Two print formats
- Provides for iQUBE2 configuration
- Supports iQUBE2 diagnostics with configurable error reporting
- Peak weight history
- Recalibration notification
- Provides local and remote reporting of diagnostics and error conditions
- Concentrated load capacity (CLC)
- Section capacity



# VIRTUi2

## APPROVALS



Load Cell Configuration



Scale Configuration

## Part Number/Price

PART #	DESCRIPTION	PRICE
108435	VIRTUi2 Virtual Indicator DEMO CD	N/C
108436	Activation Part Number Requires Machine ID and Customer's email address	\$500.00

# SCT-10

Signal Conditioning Transmitter/Indicator

## Specifications

### Power:

Input: 12 -24 VDC  
Power consumption: 5 watts

### Excitation Voltage:

5VDC, 120mA, 8 x 350Ω

### Analog Signal Input Range:

+/- 19.5mV

### Analog Signal Sensitivity:

0.1 μV/graduation minimum  
1.0 μV/graduation recommended

### A/D Sample Rate:

80 Hz

### Resolution:

Internal resolution: 16 million counts  
Weight display resolution: 999,999  
System Linearity: ± 0.01% full scale

### Digital Inputs/Outputs:

2 inputs 5-24VDC, 2 outputs 24VDC/60mA N.O. or N.C. (solid state)

### Serial Port:

RS-485 or RS-232 simplex supports up to 115,200 bps

### Analog Output:

Optoisolated, 16 bit  
0-20mA, 4-20mA (max 300 ohm)  
0-10VDC, 0-5VDC, -10 to 10VDC, 5 to 5VDC, (min 10k ohm)

### Display:

0.3 in (8 mm), six digit, 7 segment LED  
Annunciators: Net, center of zero, stability, KG, G, LB  
Annunciators test status of inputs/outputs

### Keyboard:

4-key membrane panel, tactile feel  
Zero, Tare, Print, Menu, Escape, Left and Up Navigation, Enter

### Operating Temperature & Humidity:

Working Temperature: -4°F to 140°F (-20°C to 60°C)  
Humidity: 85% non-condensing

### Dimensions (WxHxD):

DIN Rail Mount: 4.84 x 3.62 x 1.96 in (123 x 92 x 50 mm)  
IP67 Enclosure: 6.69 x 5.51 x 3.74 in (170 x 140 x 95 mm)

### Weight:

1 lb (0.5 kg)

### Rating/Material:

DIN Rail Mount: NEMA 1  
Sealed enclosure: NEMA 4X/IP67, plastic enclosure, clear cover, six PG 9 cord grips

### Warranty:

One-year limited warranty

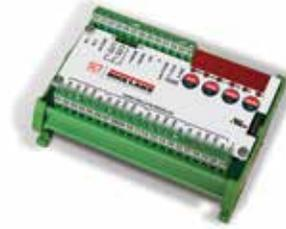

Din Rail Mount



IP67 Enclosure

## APPROVALS



## Standard Features

- Converts digital weight to analog output
- Sums 4 input channels in parallel
- Theoretical calibration, real-weigh calibration, linearity calibration
- Push button or preset tare
- Full-scale analog output with zero setting and PLC correction of analog signal
- Displays weight, configuration, calibration and error conditions
- DIN rail mounting, suitable for back panel
- Two digital inputs, two digital outputs
- One serial port, RS-232 simplex and RS-485 connection
- Supports ASCII or MODBUS-RTU protocols
- CD manual

## Part Number/Price

PART #	DESCRIPTION	WEIGHT	PRICE
129393	SCT Converter with analog output	1 lb	\$400.00
129394	SCT Converter with analog output in enclosure	1 lb	550.00
88792	12VDC 1.2 A DIN Rail Mounted power supply	1 lb	130.00
119244	24VDC 1.3 A DIN Rail Mounted power supply	1 lb	130.00
131129	Installation manual		25.00

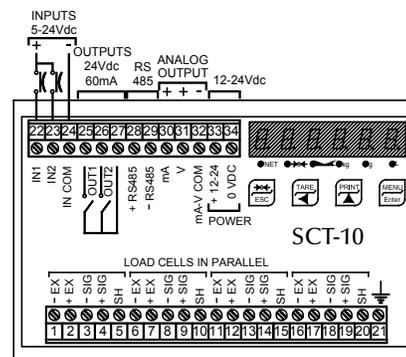

# SCT-20

## Signal Conditioning Transmitter/Indicator

### Specifications

**Power:**

Input: 12 -24 VDC  
Power consumption: 5 watts

**Excitation Voltage:**

5VDC, 120mA, 8 x 350Ω

**Analog Signal Input Range:**

+/- 39mV

**Analog Signal Sensitivity:**

0.1 μV/graduation minimum  
1.0 μV/graduation recommended

**A/D Sample Rate:**

300 Hz

**Resolution:**

Internal resolution: 16 million counts  
Weight display resolution: 999,999  
System linearity: ± 0.01% full scale

**Digital Inputs/Outputs:**

2 inputs 5-24VDC, 3 outputs 115VAC/150mA N.O. or N.C. (dry contact)

**Serial Port:**

RS-485 or RS-232 simplex supports up to 115,200 bps

**Analog Output:**

Optoisolated, 16 bit  
0-20mA, 4-20mA (max 300 ohm)  
0-10VDC, 0-5VDC (min 10k ohm)

**Display:**

0.3 in (8 mm), six digit, seven segment LED  
Annunciators: Net, center of zero, stability, KG, G, LB

**Keyboard:**

4-key membrane panel, tactile feel  
Zero, Tare, Print, Menu, Escape, Left & Up Navigation, Enter

**Operating Temperature & Humidity:**

Working Temperature: -4°F to 140°F (-20°C to 60°C)  
Humidity: 85% non-condensing

**Dimensions (W x H x D):**

SCT converter: 0.98 x 4.52 x 4.72 in (25 x 115 x 120 mm)

**Weight:**

1 lb (0.5 kg)

**Rating/Material:**

SCT enclosure: NEMA 1 plastic pluggable connectors

**Warranty:**

One-year limited warranty



### APPROVALS



Shown with DeviceNet Connection

### Standard Features

- Space saving, vertical shape with DIN rail mounting
- Displays weight, configuration, calibration and error conditions
- DIN rail mounting
- Theoretical calibration, real-weigh calibration, linearity calibration
- Push button or preset tare
- Converts digital weight to analog output or optional DeviceNet™ or Profibus® or EtherNet/IP Protocol
- Supports ASCII or MODBUS-RTU protocols
- Full-scale analog output with zero setting and PLC correction of analog signal
- Bit swapping selection for little endian and big endian format
- Two digital inputs, three digital outputs
- One serial port, RS-232 simplex and RS-485 connection
- CD manual

### Part Number/Price

PART #	DESCRIPTION	WEIGHT	PRICE
129396	SCT converter with Analog output	1 lb	\$400.00
129397	SCT converter with DeviceNet output	1 lb	600.00
129558	SCT converter with Profibus DP	1 lb	600.00
129398	SCT converter with EtherNet/IP	1 lb	750.00
132534	SCT converter with TCP/IP	1 lb	750.00
156903	SCT converter with Modbus/TCP	1 lb	750.00
88792	12VDC 1.2 A DIN Rail Mounted power supply	1 lb	130.00
119244	24VDC 1.3 A DIN Rail Mounted power supply	1 lb	130.00
131128	Installation manual	1 lb	25.00

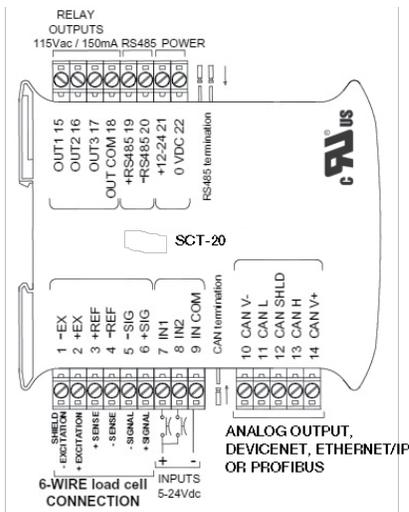

Dimensions: 25 x 115 x 120mm

# SCT-30

Signal Conditioning Transmitter/Indicator

## Specifications

**Power:**

Input: 12 -24 VDC  
Power consumption: 3 watts

**Excitation Voltage:**

5VDC, 120mA, 8 x 350Ω

**Analog Signal Input Range:**

+/- 39mV

**Analog Signal Sensitivity:**

0.1 μV/graduation minimum  
1.0 μV/graduation recommended

**A/D Sample Rate:**

300 Hz

**Resolution:**

Internal resolution: 16 million counts  
System linearity: ± 0.01% full scale

**Serial Port:**

RS-485

**Analog Output:**

Optoisolated, 16 bit  
0-20mA, 4-20mA (max 300 ohm)  
0-10VDC, 0-5VDC (min 10k ohm)

**Display:**

Eight-digit alphanumeric tow line LCD, 5 mm high

**Operating Temperature & Humidity:**

Working Temperature: -4°F to 140°F (-20°C to 60°C)  
Humidity: 85% non-condensing

**Dimensions (W x H x D):**

SCT converter: 3.54 x 3.74 x 2.36 in  
(90 x 95 x 60 mm)  
IP67 enclosure: 6.69 x 5.51 x 3.74 in  
(170 x 140 x 95 mm)

**Weight:**

1 lb (0.5 kg)

**Rating/Material:**

DIN rail mount: NEMA 1  
Sealed enclosure: NEMA 4/IP67, plastic enclosure, clear cover, six PG9 cord grips

**Warranty:**

One-year limited warranty



SCT converter with analog output

## APPROVALS



## Standard Features

- Powers up to eight (350Ω) load cells in parallel (with a 24-bit A/D converter)
- A/D converter 24-bit (16000000 points) 4.8 kHz
- 16-bit analog output: 0-20 mA, 4-20 mA, 0-5 V, 0-10 V, ±5 V, and ±10 V
- Mounting on Omega/DIN rail for back panel or junction box
- IP67-rated enclosed versions
- Diagnostic message for load cell disconnect and over capacity errors

## Part Number/Price

PART #	DESCRIPTION	WEIGHT	PRICE
156794	SCT converter with analog output	1 lb	\$325.00
156834	SCT converter with analog output in enclosure	1 lb	475.00
88792	12VDC 1.2A DIN Rail Mount power supply	1 lb	130.00
119244	24VDC 1.3A DIN Rail Mount power supply	1 lb	130.00
131129	Installation manual	1 lb	25.00



# Intrinsically Safe Relays and Racks

## Input/Output Components



OPTO 22 G4 PN-45408

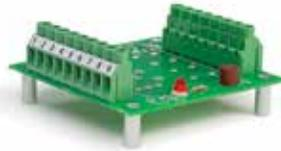

OPTO 22 G4 PN-15973



Dayton multi-function relay



Allen-Bradley® multi-function relay with digital display

## Grayhill Relays and Racks



8-channel relay rack

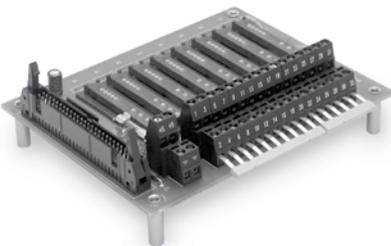
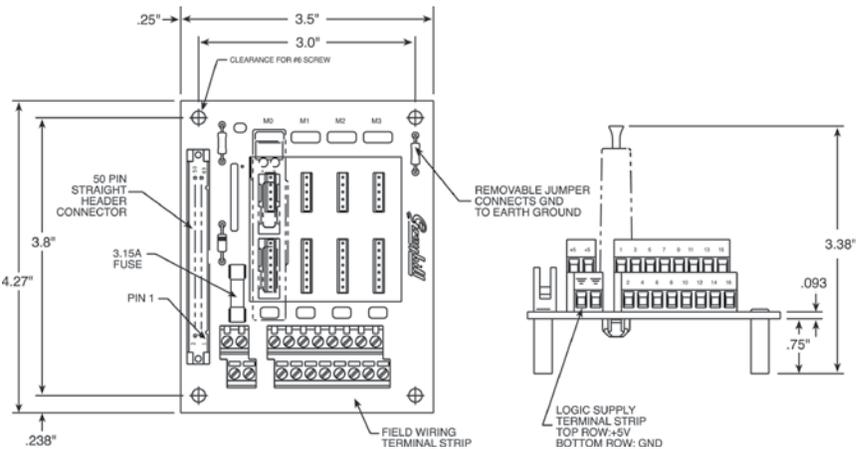

16-channel relay rack

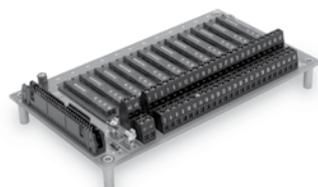
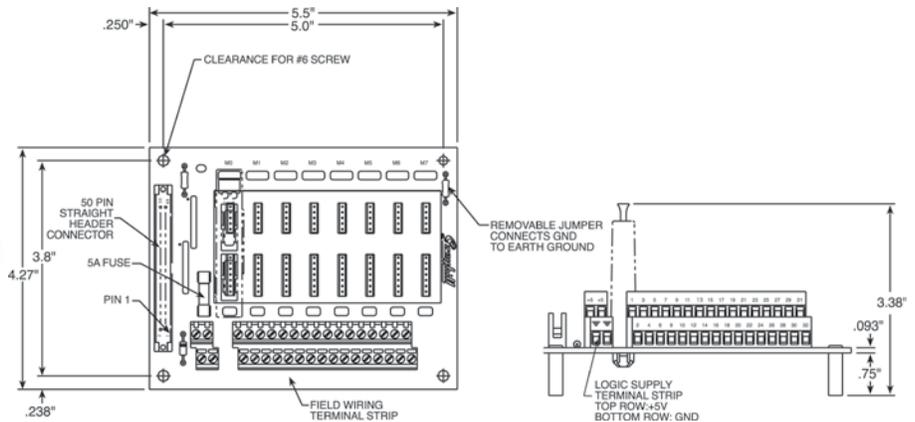

24-channel relay rack

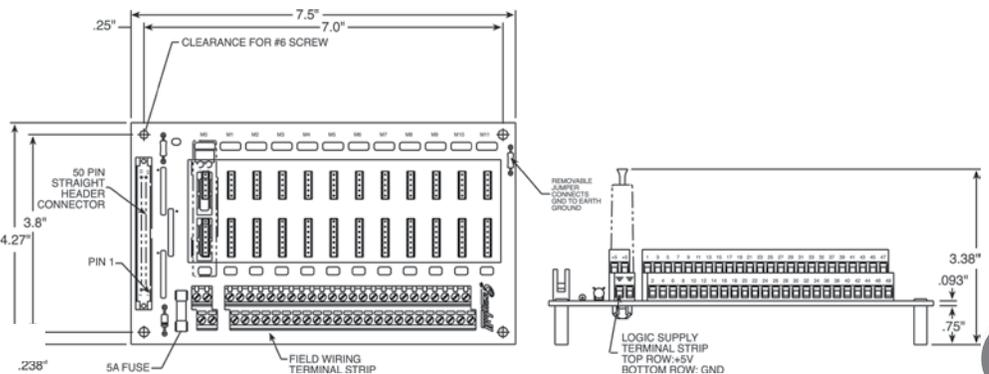

Intrinsically Safe

# Input and Output Components/ Grayhill and OPTO 22 Relays and Racks

INDICATORS / CONTROLLERS

## Part Number/Price

PART #	DESCRIPTION	PRICE
<b>Input/Output Component</b>		
43942	Allen-Bradley® multi-function relay with digital display	\$415.00
29616	Dayton multi-function relay	205.00
<b>Other Relays</b>		
15952	8-Pin octal relay, AC/DC output, 10A, 120VAC coil	54.00
15960	8-Pin octal relay, AC/DC output, 10A, 6VDC coil	30.00
15961	8-Pin octal socket	20.00
<b>Grayhill Relays and Racks</b>		
52332	2-channel input relay, 2.5-28VDC	45.00
52318	2-channel input relay, 120VAC	45.00
52319	2-channel input relay, 240VAC	45.00
52331	2-channel input relay, 10-32VDC	45.00
52316	2-channel output relay, 120-140VAC at 2 amp	45.00
52317	2-channel output relay, 240-280VAC at 7 amp	45.00
71376	2-channel output relay, 3-60VDC t 1 amp	65.00
71377	2-channel output relay, 0-200VDC/VAC at 1.5A/10W (dry contact)	85.00
52331	2-channel input relay, 10-32 VDC	45.00
84698	2-channel output relay, inductive load, 120-140VAC at 2A	65.00
84699	2-channel output relay, inductive load, 240-280VAC t 2A	65.00
52312	8-channel relay rack, 920i panel mount, wall mount requires 50-Pin connector (4 slots)	135.00
52314	16-channel relay rack, 920i panel mount, wall mount requires 50-Pin connector (8 slots)	185.00
52315	24-channel relay rack, 920i panel mount, wall mount requires 50-Pin connector (12 slots)	285.00
76644	8-channel relay rack, DIN rail mount, requires 50-Pin connector (4 slots)	155.00
76645	16-channel relay rack, DIN rail mount, requires 50-Pin connector (8 slots)	235.00
76646	24-channel relay rack, DIN rail mount, requires 50-Pin connector (12 slots)	525.00
46189	Jumper strap, 10 position for Grayhill	5.00
108396	Digital input 5VDC, 15-30 VAC/10-32VDC	35.00
108397	Digital output 5VDC, 3-60VDC	35.00
70780	Cable, 50-Pin flat ribbon for digital I/O	50.00
70779	Cable, 50-Pin round ribbon for digital I/O with cord grip	150.00
72442	Cable, 50-Pin round ribbon for digital I/O without cord grip	145.00
155253	Board assembly, MWM IV, 8-channel, OPTO 22 GU Series compatible	125.00

## OPTO 22 Relays and Racks

PART #	DESCRIPTION	PRICE
15969	G4IDC5 10-32VDC Input relay module, white (N/O)	\$30.00
15970	G40DC5R Dry contact 100VDC/1.5A output, red (N/O)	35.00
22848	G40DC5R5 Dry contact 100VDC/1.5A output, red (N/C)	35.00
15971	G40AC5 115VAC Output relay module, black (N/O)	35.00
15972	G4IAC5 115VAC Input relay module, yellow (N/O)	35.00
22847	G40AC5A5 115/230VAC Output relay module, black (N/C)	35.00
36632	G40AC5A 115/230VAC Output relay module, black (N/O)	35.00
36631	G4IAC5A 230VAC Input relay module, yellow (N/O)	35.00
16478	Quencharc arc suppressor	11.00
101923	FRP Enclosure with Opto 4-channel rack	235.00
15973	4-channel relay rack, 3.25 x 3.25 in	100.00
45408	4-channel relay rack 6.1 x 1.2 in	150.00
99032	Adapter plate, for 4-channel OPTO rack 33490	5.00
<b>Relay Boards Fixed Dry Contact Relay</b>		
30549	2-channel 120-240VAC or 30VDC/5A	150.00
15959	4-channel 120-240VAC or 30VDC/5A	250.00
29615	Board, Relay mounting I channel (requires din rail for mounting)	65.00

www.ricelake.com | Phone: 800-472-6703

RICE LAKE

# Explosive Environment Equipment Policy



Caution The equipment contained within this Explosive Environment section requires greater attention to specification and installation guidelines. Improper specification, installation or service of these products can result in loss of equipment or serious injury.

Rice Lake Weighing Systems has assembled the very best in Intrinsically Safe and Explosion-Proof equipment. In order to properly specify, install and service this equipment, it is necessary that our distributors understand and appreciate the possible risks involved.

**In an effort to educate our customers on some of the precautions required, we created an Explosive Environment Review. Available upon request, this booklet reviews the following:**

- Explosive environment designations: Class, Division and Group
- Standards and Codes applicable to hazardous environment equipment
- Equipment liability
- Theory of Intrinsically Safe, Explosion-Proof and Purged systems
- Equipment specification guidelines
- Proper installation procedures
- Service precautions

**The Explosive Environment Product Review booklet also includes the resource information listed below:**

- NFPA 70, "National Electrical Code (NEC) Handbook"
- NFPA 496, "Classification of Gases, Vapors, and Dusts for Electrical Equipment in Hazardous (Classified) Locations"
- ANSI/UL 913, "Standard for Intrinsically Safe Apparatus and Associated Apparatus for use in Class I, II and III, Division 1 Hazardous Locations"
- ANSI/ISA RP 12.6, "Installation of Intrinsically Safe Instrument Systems for Hazardous (Classified) Locations"
- FM Approval Standard 3610, "Approval Standard, Intrinsically Safe Apparatus and Associated Apparatus for use in Class I, II and III, Division 1 Hazardous Locations"
- FM Approval Standard 3615, "Approval Standards, Explosion Proof Electrical Equipment"
- "Electrical Installations in Hazardous Locations"

**Plant Safety Engineers and Certified Electricians should always be involved in the specification and installation of any Explosive Environment Equipment.**

**Please see the next page for assistance in selecting Hazardous Area Control Equipment for your application requirements.**

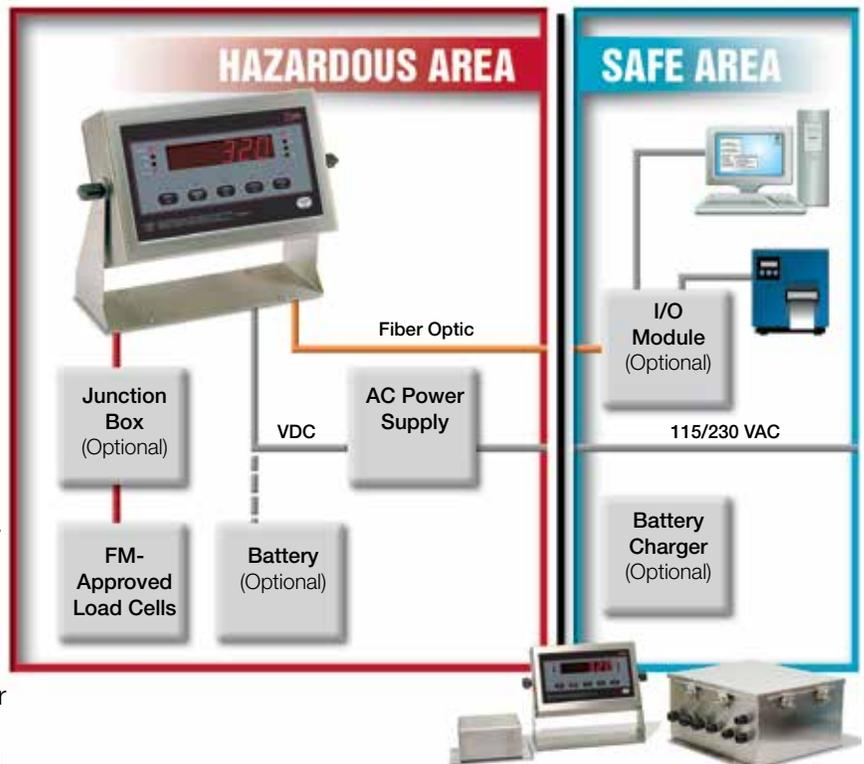

Intrinsically Safe

# Hazardous Area Classification

For assistance in selecting Hazardous Area Control Equipment for your application requirements, please complete this form and submit, along with a description of the application, to:



### Rice Lake Weighing Systems

Attn: Hazardous Environment  
230 West Coleman Street  
Rice Lake, WI 54868  
Telephone: 715-234-9171 • Fax: 715-234-6967

INDICATORS / CONTROLLERS

RLWS File #: _____	Date: _____	<b>For RLWS Office Use Only</b>
Sales Order #: _____	Checked By: _____	
Equipment PN#(s) & Serial Number(s): _____		
Factory Mutual Not Applicable _____	(International Orders Only) _____	

### RLWS CUSTOMER INFORMATION:

**RLWS Customer Name:** \_\_\_\_\_ **Customer Number:** \_\_\_\_\_

Address: \_\_\_\_\_

City: \_\_\_\_\_ State: \_\_\_\_\_ Zip: \_\_\_\_\_

Telephone: ( \_\_\_\_\_ ) \_\_\_\_\_ Fax: ( \_\_\_\_\_ ) \_\_\_\_\_

Contact Name: \_\_\_\_\_  
(Printed name) (Signature) (Date)

Authorized Signature: \_\_\_\_\_  
(Printed name) (Signature) (Date)

### END USER INFORMATION:

End User Company Name: \_\_\_\_\_

Address: \_\_\_\_\_

City: \_\_\_\_\_ State: \_\_\_\_\_ Zip: \_\_\_\_\_

Telephone: ( \_\_\_\_\_ ) \_\_\_\_\_ Fax: ( \_\_\_\_\_ ) \_\_\_\_\_

Contact Name: \_\_\_\_\_  
(Printed name) (Signature) (Date)

Authorized Signature: \_\_\_\_\_  
(Printed name) (Signature) (Date)

Title: \_\_\_\_\_

(The following information is to be defined and completed by the END USER'S Plant Safety Engineer or other authorized party)

Hazardous Area Classification: Class \_\_\_\_\_, Division \_\_\_\_\_, Group \_\_\_\_\_

Specific Hazard/Material (please print): \_\_\_\_\_

Defining Individual: \_\_\_\_\_  
(Printed name) (Signature) (Date)

Defining Authority (Title): \_\_\_\_\_

Please retain a copy of this completed form for your records.

www.ricelake.com | Phone: 800-472-6703

RICE LAKE



Caution The equipment contained within this Explosive Environment section requires greater attention to specification and installation guidelines. Improper specification, installation or service of these products can result in loss of equipment or serious injury.

### EXPLOSION PROOF SYSTEM

What is an explosion-proof indicator?

It's simply a digital weight indicator enclosed in a special case. The purpose of an explosion-proof indicator is not, as the name suggests, to protect the indicator. Instead, the case PreVents any explosion WITHIN the case from causing subsequent fire or explosion in the surrounding atmosphere.

For example, in a grain elevator application, combustible dusts (Class II hazardous atmosphere) may be present. A spark in a non-explosion-proof indicator could ignite an elevator-wide explosion. However, with an explosion-proof indicator, the spark (or even an explosion) is contained within the case. The hazardous atmosphere cannot be ignited, and the elevator is protected.

#### ADVANTAGES

- Explosion containment
- Requires low maintenance
- No electronics
- No moving parts

#### DISADVANTAGES

- Cannot indicate failure of containment capability
- Cost of protection per cubic foot increases with enclosure size
- Promotes condensation
- Cumbersome, limited access
- Causes harmful heat build-up
- Limited sizes
- Bulky designs
- Excessive weight

### PURGE SYSTEM

Purged systems are ideal for hazardous environments and use positive pressure to PreVent particles, gases and fibers from entering the controller enclosure. As an added safeguard, a differential pressure switch automatically cuts off power when the pressure falls below the acceptable level. Type X, Y and Z purging hardware is available that meets National Fire Protection Association (NFPA) article 496 guidelines. The three configurations are as follows:

**Type X Pressurizing:** Reduces the classification within the protected enclosure from Division 1 to Safe.

**Type Y Pressurizing:** Reduces the classification within the protected enclosure from Division 1 to Division 2.

**Type Z Pressurizing:** Reduces the classification within the protected enclosure from Division 2 to Safe.

#### ADVANTAGES

- Reduces heat build-up
- Inhibits metal corrosion
- Requires low maintenance
- Increases equipment longevity
- Allows fast access to equipment
- Reduces moisture and dust build-up
- Reduces classification within enclosure
- Continuous system status indication
- Protects enclosures up to 450 cubic feet
- Allows use of any enclosure shape
- Cost of protection per cubic foot decreases with enclosure size

#### DISADVANTAGES

- Contains moving parts
- Requires instrument air supply

- Some systems contain electronics
- Some systems require electrical power

### INTRINSICALLY SAFE SYSTEM

Intrinsically safe load cells and safety barriers take the explosion proof principle a step further. Intrinsic safety ensures that the indicator's electrical wiring and components are, by design, incapable of releasing enough energy to ignite flammable or combustible atmospheric mixtures in their most easily ignitable concentrations. In short, an intrinsically safe device eliminates the conditions for an explosion, no matter what the circumstances.

#### ADVANTAGES

- Limits energy to device
- Requires low maintenance
- No moving parts
- Ideal for sensors

#### DISADVANTAGES

- One barrier is required for each conductor
- Project cost increases with number of conductors
- Offers no protection against heat, moisture and dust
- Requires protection or installation in nonclassified area
- 24 VDC, 50 mA maximum power and signal strength limit

## Hazardous Atmospheres (for reference only)

Hazardous atmospheres are divided into three general classes and two divisions:

**CLASS I:** Flammable Gases or Vapors

**CLASS II:** Combustible Dusts

**CLASS III:** Ignitable Fibers or Flyings

**DIVISION 1:** Hazard exists under normal conditions.

**DIVISION 2:** Hazardous material is handled, processed or stored. Hazard is not normally present, but may be released due to accident or equipment malfunction.

### CLASS I:

Flammable Gases or Vapors

**CLASS I, GROUP A:** (d)  
acetylene

### CLASS I, GROUP B:

 (d)

acrolein (inhibited)  
arsine  
butadiene  
ethylene oxide  
hydrogen  
manufactured gases containing more than 30% hydrogen by volume  
propylene oxide  
propyl nitrate

### CLASS I, GROUP C:

 (c, d)

acetaldehyde  
allyl alcohol  
n-butyraldehyde  
carbon monoxide  
crotonaldehyde  
cyclopropane  
diethyl ether  
diethylamine  
epichlorohydrin  
ethylene  
ethylenimine  
ethyl mercaptan  
ethyl sulfide  
morpholine  
2-nitropropane  
tetrahydrofuran  
unsymmetrical dimethyl hydrazine (UMDH 1, 1-dimethyl hydrazine)

### CLASS I, GROUP D:

 (c, d)

acetic acid  
acetone  
acrylonitrile  
ammonia  
benzene  
butane  
1-butanol (butyl alcohol)  
2-butanol (secondary butyl alcohol)  
n-butyl acetate  
isobutyl acetate  
di-isobutylene  
ethane  
ethanol (ethyl alcohol)  
ethyl acetate  
ethyl acrylate (inhibited)  
ethylene diamine (anhydrous)  
ethylene dichloride  
ethylene glycol monomethyl ether  
gasoline  
heptanes  
hexanes  
isoprene  
isopropyl ether  
mesityl oxide  
methane (natural gas)  
methanol (methyl alcohol)  
3-methyl 1-butanol (isoamyl alcohol)  
methyl ethyl ketone  
2-methyl 1-propanol (isobutyl alcohol)  
2-methyl 2-propanol (tertiary butyl alcohol)  
petroleum naphtha  
pyridine  
octanes  
pentanes  
1-pentanol (amyl alcohol)  
propane  
1-propanol (propyl alcohol)  
2-propanol (isopropyl alcohol)  
propylene  
styrene  
toluene  
vinyl acetate  
vinyl chloride  
xylenes

### CLASS II:

**Combustible Dusts** (c)

### CLASS II, GROUP E

 (c, d)

Atmospheres containing metal dust, including aluminum, magnesium, and their commercial alloys, as well as other metals of similarly hazardous characteristics with a resistivity of 100 ohms per centimeter.

### CLASS II, GROUP F

 (c, d)

Atmospheres containing carbon black, charcoal, coal or coke dusts that have more than 8 percent total volatile material, or atmospheres containing these dusts sensitized by other materials so that they present an explosion hazard. They will also have a resistivity greater than 100 ohms per centimeter and equal to or less than 100 megohms per centimeter.

### CLASS II, GROUP G

 (c, d)

Atmospheres containing flour, starch or grain as well as combustible plastics or chemical dusts having resistivity greater than 1 megohm per centimeter.

### CLASS III:

**Ignitable Fibers or Flyings** (c, d)

Atmospheres containing parts of rayon, cotton and other textiles. Combustible fiber manufacturing and processing plants such as cotton gins, cottonseed mills, flax processing plants, clothing manufacturing plants, sawmills and other woodworking locations.

Easily ignitable fibers including rayon, cotton (including cotton linters and cotton wastes), sisal or henequen, istle, jute, hemp, tow, cocoa, oakum, baled waste kapok, Spanish moss, excelsior, sawdust, wood chips and other similar materials.

Intrinsically Safe

# 320IS

Intrinsically Safe Digital Weight Indicator

## Specifications

### Load Cell Excitation:

3.0VDC at 87.5 Ω  
4.6VDC at 700 Ω

### Load Cell Current:

34 mA (4 x 350 Ω load cells) or (8 x 700 Ω load cells)

### Load Cell Cabling:

4 and 6-wire with remote sensing (recommended)

### Analog Signal Input Range:

0.6 mV/V - 4.0 mV/V

### Analog Signal Sensitivity:

0.2 μV/graduation minimum  
1.5 μV/graduation recommended

### Conversion Rate:

60 updates/second

### Resolution:

10,000 displayed graduations (NTEP),  
100,000 expanded

The maximum number of allowed graduations will vary by application

### Display Increments:

1, 2, 5

### Display:

Six-digits, Light Emitting Diode (LED);  
16-segment, 0.8 in (20 mm) digits

### Decimal Point:

Configurable with dead zeros

### Unit Switching:

Configurable for two units of measurement with front panel operation with conversion for tare and setpoint values

### Front Panel Control Switches:

Zero, Gross/Net, Tare, Print, Units Conv

### Front Panel:

6-button flat membrane panel

### Front Panel LED Annunciators:

Center Zero, Gross, Net, Motion, lb, kg, oz, g

### Motion Band:

Configurable to ±1 or ±3 graduations, 1 second delay (or Off)

### Power Input:

5.8 - 7.9VDC, 100 - 175 mA  
Maximum power consumption 0.25 watts

### Operating Temperature:

14°F to 104°F (-10°C to 40°C) legal

### Rating/Material:

Stainless steel NEMA 4X/IP66 enclosure

### Optional Battery:

Operating times: 4 x 350 Ω = 35-40 hrs  
1 x 350 Ω = 40-50 hrs  
8 x 700 Ω = 35-40 hrs  
Charging Times: 10 hours for dead battery,  
14 hours for initial charge

### Weight:

6.1 lb (2.8 kg)

### Warranty:

One-year limited warranty

### Approvals:

NTEP CC 03-078 Class III/III 10,000d  
(TUV, C (UL), FM Entity)  
Measurement Canada AM-5560



## APPROVALS



Measurement  
Canada  
Approved



## Standard Features

- Factory Mutual (FM) entity approved for Classes I, II, and III, Divisions I and 2, Groups A, B, C, D, E, F, and G
- Bright Light Emitting Diode (LED)
- Stainless steel NEMA 4X/IP66 enclosure
- T4 temperature rating
- Front-panel digital calibration
- Automatic zero and span temperature compensation
- Excitation for four 350 Ohms or eight 700 Ohms load cells
- Gross/Tare/Net computation
- Tilt stand
- Factory Mutual (FM) Entity approved
- F
- Power ON/OFF; battery save mode
- I/O Module Option: 2 duplex serial ports, 2 analog outputs, 4 digital inputs, 4 relay contact outputs.
- 300 character serial string

FM Entity Approved for use in hazardous locations per Rice Lake Weighing Systems control drawing file number 72717.

Rice Lake Weighing Systems® warrants that all Rice Lake Weighing Systems Intrinsically Safe (IS) equipment and systems installed by a distributor or Original Equipment Manufacturer (OEM) will operate per written specifications as confirmed by the Distributor/OEM and accepted by Rice Lake Weighing Systems. All systems and components are warranted against defects in materials and workmanship for one year.

All Rice Lake Weighing Systems Intrinsically Safe equipment carries a Factory Mutual approval and is documented on various control drawings. Each device is manufactured Rice Lake Weighing Systems factory authorized personnel. To preserve the warranty and Factory Mutual approval, all repairs or replacement of circuit boards or components housed within the enclosures must be performed by Rice Lake Weighing Systems factory authorized personnel.



**CAUTION!** The equipment contained within this Explosive Environment section requires greater attention to specification and installation guidelines. Improper specification, installation or service of these products can result in loss of equipment or serious injury.

Intrinsically Safe

# 320IS

Intrinsically Safe Digital Weight Indicator

INDICATORS / CONTROLLERS

## Part Number/Price

PART #	DESCRIPTION	PRICE
91233	320IS Intrinsically-Safe Digital Weight Indicator five button keypad with battery pack and charger & tilt stand	\$1,727.00
91234	320IS Intrinsically-Safe Digital Weight Indicator five button with A/C power supply	1,740.00
86241	320IS indicator only	995.00
<b>Hazardous Environment Cable</b>		
32817	EL147IS hazardous environment cable	2.85/ft
72241	Hazardous environment 3 conductor	2.25/ft
78026	Fiber optic, duplex cable 100 ft	135.00
78027	Fiber optic, duplex cable 200 ft	270.00

## Options/Accessories

PART #	DESCRIPTION	PRICE
72713	Power supply, IS-EPS-100-240 VAC	\$745.00
72725	IS-6V battery option with cable adapter	535.00
74001	Battery charger, 115VAC	145.00
74002	Battery charger, 115/230VAC	535.00
80869	Fuse, 1.25A, 250V TR5 time-lag (replacement part for the I/O Module)	2.50
72726	Tilt stand (required for battery model)	57.00
*89239	I/O module, stainless steel NEMA 4 enclosure, safe area option (requires fiber optic cable, AC power required)	1,295.00
83388	Timer relay kit includes din rail, timer relay for latching and mount	370.00
74612	Installation manual	35.00
78076	I/O module manual	30.00

\* Includes relays

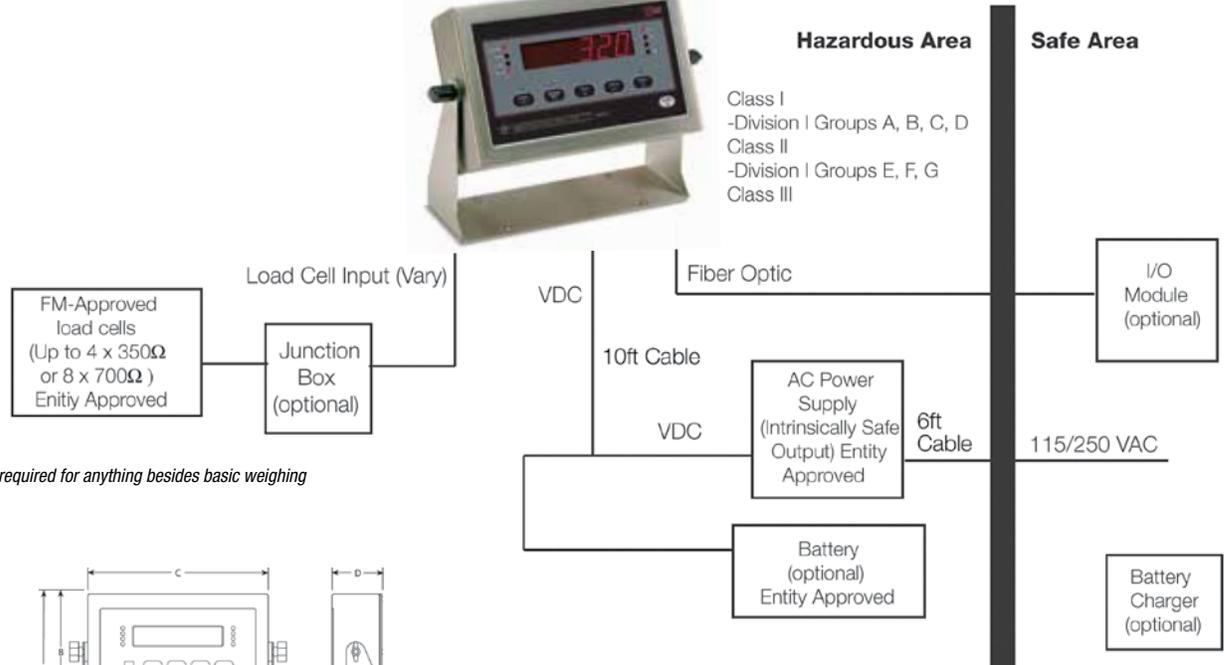

\*I/O module required for anything besides basic weighing

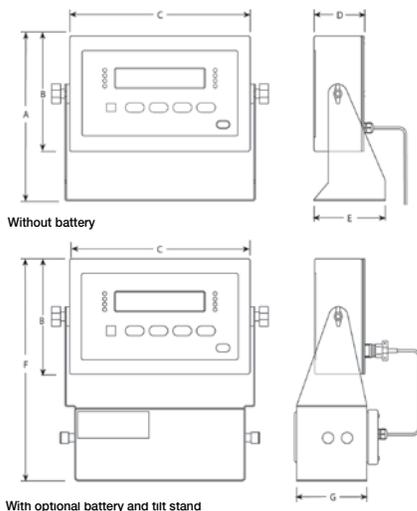

## DIMENSIONS

### Without Battery

A	8.56 in (217.4 mm)	D	2.64 in (67.1 mm)
B	6.00 in (152.4 mm)	E	3.75 in (95.2 mm)
C	9.50 in (241.3 mm)		

### With Optional Battery and Tilt Stand

F	11.56 in (293.6 mm)	G	4.75 in (120.7 mm)
---	---------------------	---	--------------------

### Optional I/O Module

12.90 x 11.63 x 6.25 in (327.7 x 295.4 x 158.8 mm)

### Optional Power Supply

7.00 x 5.13 x 3.125 in (177.8 x 130.0 x 79.375 mm)



**CAUTION!** The equipment contained within this Explosive Environment section requires greater attention to specification and installation guidelines. Improper specification, installation or service of these products can result in loss of equipment or serious injury.

www.ricelake.com | Phone: 800-472-6703

RICE LAKE



Intrinsically Safe  
**320IS Plus**  
Intrinsically Safe Digital Weight Indicator

## Specifications

**Load Cell Excitation:**

3.0VDC at 87.5  $\Omega$   
4.6VDC at 700  $\Omega$

**Load Cell Current:**

34 mA (4 x 350  $\Omega$  load cells) or (8 x 700  $\Omega$  load cells)

**Load Cell Cabling:**

4 and 6-wire with remote sensing (recommended)

**Analog Signal Input Range:**

0.6 mV/V - 4.0 mV/V

**Analog Signal Sensitivity:**

0.2  $\mu$ V/graduation minimum 1.5  $\mu$ V/graduation recommended

**Conversion Rate:**

60 updates/second

**Resolution:**

10,000 displayed graduations (NTEP), 100,000 expanded  
The maximum number of allowed graduations will vary by application

**Display Increments:**

1, 2, 5

**Display:**

Six digits, Light Emitting Diode (LED); 16-segment,  
0.8 in (20 mm) digits

**Decimal Point:**

Configurable with dead zeros

**Unit Switching:**

Configurable for two units of measurement with front  
panel operation with conversion for tare and setpoint values

**Front Panel Control Switches:**

Zero, Gross/Net, Tare, Print, Units Conv, Start, Stop, Accum, Tare Display

**Front Panel:**

24-button flat membrane panel

**Front Panel LED Annunciators:**

Center Zero, Gross, Net, Motion, lb, kg, oz, g

**Motion Band:**

Configurable to  $\pm 1$  or  $\pm 3$  graduations, 1 second delay (or Off)

**Power Input:**

5.8 - 7.9VDC, 100 - 175 mA  
Maximum power consumption 0.25 watts

**Operating Temperature:**

14°F to 104°F (-10°C to 40°C) legal

**Rating/Material:**

Stainless steel NEMA 4X/IP66 enclosure

**Optional Battery:**

Operating Times: 4 x 350  $\Omega$  = 35-40 hrs. 1 x 350  $\Omega$  = 40-50 hrs.  
Charging Times: 10 hours for dead battery, 14 hours for initial charge

**Weight:**

6.1 lb (2.8 kg)

**Warranty:**

One-year limited warranty

**Approvals:**

NTEP pending (TUV, C (UL), FM Entity 03-078) Class III/IIIL 10,000d  
Measurement Canada AM-5560



## APPROVALS



Measurement  
Canada  
Approved



## Standard Features

- Bright Light Emitting Diode (LED)
- Stainless steel NEMA 4X/IP66 enclosure
- T4 temperature rating
- Front panel digital calibration
- Automatic zero and span temperature compensation
- Excitation for four 350 Ohms or eight 700 Ohms load cells
- Gross/Tare/Net computation
- Tilt stand
- Factory Mutual (FM) Entity approved
- Duplex fiber optic interface
- Power ON/OFF; battery save mode
- I/O Module Option: two serial ports, two analog outputs, four digital inputs, four relay contact outputs.
- Eight setpoint (requires I/O module)
- Factory Mutual (FM entity approved for classes I, II, and III; Divisions 1 and 2; Groups A, B, C, D, E, F, and G)
- Time & Date (requires I/O module)

*FM Entity Approved for use in hazardous locations per Rice Lake Weighing Systems control drawing file number 72717.*

Rice Lake Weighing Systems® warrants that all Rice Lake Weighing Systems Intrinsically Safe (IS) equipment and systems installed by a distributor or Original Equipment Manufacturer (OEM) will operate per written specifications as confirmed by the Distributor/OEM and accepted by Rice Lake Weighing Systems. All systems and components are warranted against defects in materials and workmanship for one year.

All Rice Lake Weighing Systems Intrinsically Safe equipment carries a Factory Mutual approval and is documented on various control drawings. Each device is manufactured Rice Lake Weighing Systems factory authorized personnel. To preserve the warranty and Factory Mutual approval, all repairs or replacement of circuit boards or components housed within the enclosures must be performed by Rice Lake Weighing Systems factory authorized personnel.



**CAUTION!** The equipment contained within this Explosive Environment section requires greater attention to specification and installation guidelines. Improper specification, installation or service of these products can result in loss of equipment or serious injury.

Intrinsically Safe

# 320IS Plus

Intrinsically Safe Digital Weight Indicator

INDICATORS / CONTROLLERS

## Part Number/Price

PART #	DESCRIPTION	PRICE
91235	320IS Plus Intrinsically-Safe Digital Weight Indicator full keypad with battery pack and charger & tilt stand	\$1,927.00
91236	320IS Plus Intrinsically-Safe Digital Weight Indicator full keypad with A/C power supply	1,940.00
86240	320IS Plus indicator only	1,195.00
<b>Hazardous Environment Cable and Fiber Optic Cable</b>		
32817	EL147IS hazardous environment cable	2.85/ft
72241	Hazardous environment 3 conductor	2.25/ft
78026	Fiber optic, duplex cable 100 ft	135.00
78027	Fiber optic, duplex cable 200 ft	270.00

## Options/Accessories

PART #	DESCRIPTION	PRICE
72713	Power supply, IS-EPS-100-240 VAC	\$745.00
72725	IS-6V battery option with cable adapter	535.00
74001	Battery charger, 115VAC	145.00
74002	Battery charger, 115/230VAC	535.00
80869	Fuse, 1.25A, 250V TR5 time-lag (replacement part for the I/O Module)	2.50
72726	Tilt stand (required for battery model)	57.00
89239	I/O Module, stainless steel NEMA 4 enclosure, safe area option (requires fiber optic cable, AC power required)	1,295.00
83388	Timer relay kit includes din rail, timer relay for latching and mount	370.00
85353	Installation manual	35.00
78076	I/O Module manual	30.00

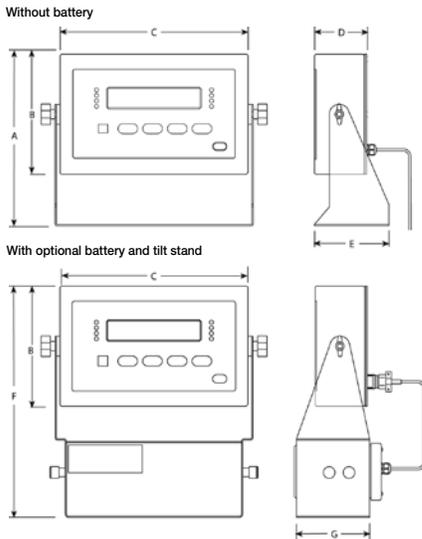
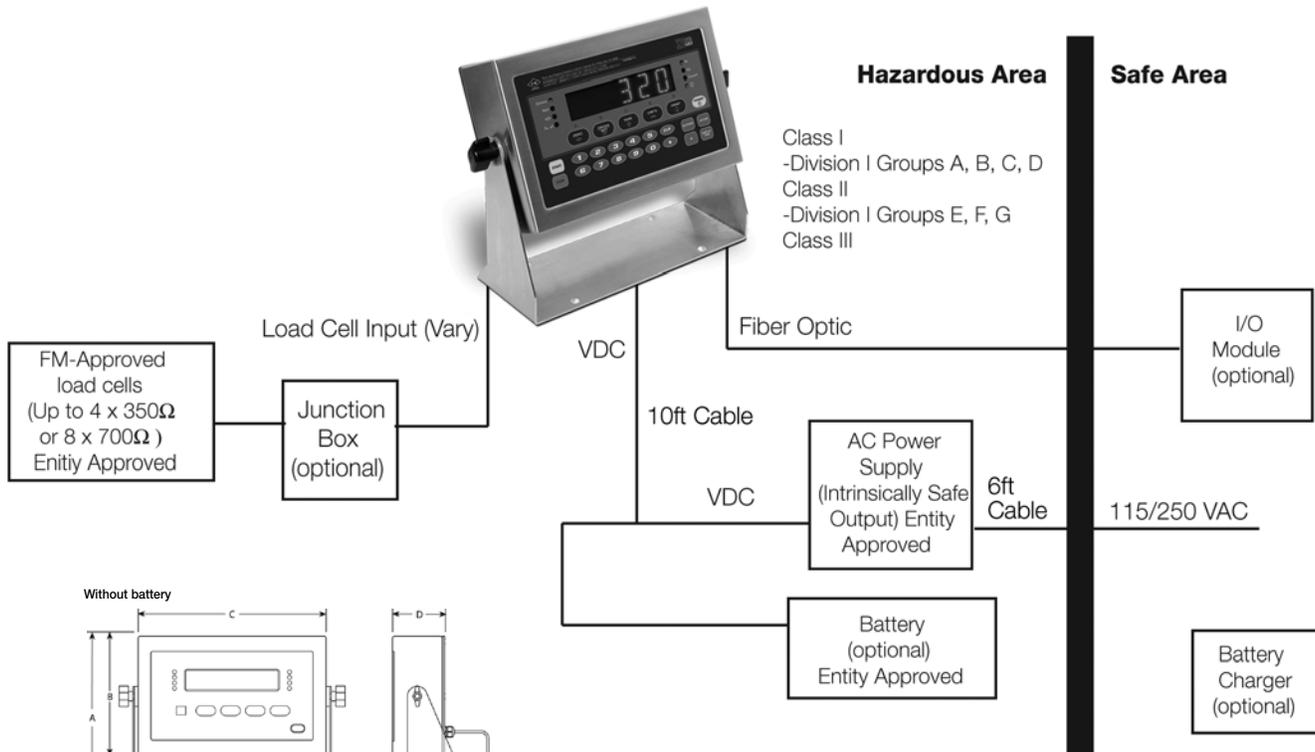

### DIMENSIONS

#### Without Battery

A	8.56 in (217.4 mm)	D	2.64 in (67.1 mm)
B	6.00 in (152.4 mm)	E	3.75 in (95.2 mm)
C	9.50 in (241.3 mm)		

#### With Optional Battery and Tilt Stand

F	11.56 in (293.6 mm)	G	4.75 in (120.7 mm)
---	---------------------	---	--------------------

#### Optional I/O Module

12.90 x 11.63 x 6.25 in (327.7 x 295.4 x 158.8 mm)

#### Optional Power Supply

7.00 x 5.13 x 3.125 in (177.8 x 130.0 x 79.375 mm)



**CAUTION!** The equipment contained within this Explosive Environment section requires greater attention to specification and installation guidelines. Improper specification, installation or service of these products can result in loss of equipment or serious injury.

www.ricelake.com | Phone: 800-472-6703

RICE LAKE

# Intrinsically Safe EL232 XPCD

Explosion Proof Remote Serial Display

## Specifications

**Display:**

High-intensity, red LED, 0.8 in (20.3 mm) high digits

**Input Voltage:**

115VAC, 60 Hz

**Weight:**

Approximately 25 lb (11.3 kg)

**NEC Classifications:**

Class I, Division 1, Groups C & D; Class II, Division 1, Groups E, F & G and Class III hazardous environments

**Baud Rate:**

1200, 2400, 4800 and 9600

**Interfaces:**

20 mA CL and RS-232 standard. The EL232 XPCD can communicate, as shipped, with 12 of the most common scale indicator families currently available. Please consult factory for model numbers and interface requirements.

**Warranty:**

One-year limited warranty

## Standard Features

- 20 mA current loop or RS-232 input
- Compatible with all IQ plus® series indicators
- NEMA 4, 7CD, 9EFG enclosure

## Part Number/Price

PART #	DESCRIPTION	EST. SHIP WEIGHT	PRICE
20904	EL232 XPCD Explosion Proof Remote Serial Display	25 lb	\$3,195.00

### DIMENSIONS

A	10.50 in (266.7 mm)	D	11.75 in (298.5 mm)
B	9.50 in (241.3 mm)	E	10.50 in (266.7 mm)
C	5.81 in (147.7 mm)	F	7.50 in (190.5 mm)
G	(Glass Diameter) 11.75 in (298.5 mm)		



**CAUTION!** The equipment contained within this Explosive Environment section requires greater attention to specification and installation guidelines. Improper specification, installation or service of these products can result in loss of equipment or serious injury.



*NOTE: The IQ plus® 310, UMC555 XPCD, and IQ plus 810 XPCD have been discontinued. The same functionality, plus an increased feature set of 520 and 920i, are available as special order XPCD enclosures. All explosion-proof devices are now built-to-order, so please coordinate purchase of these items with one of our application specialists.*

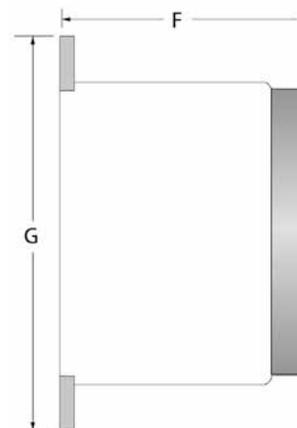
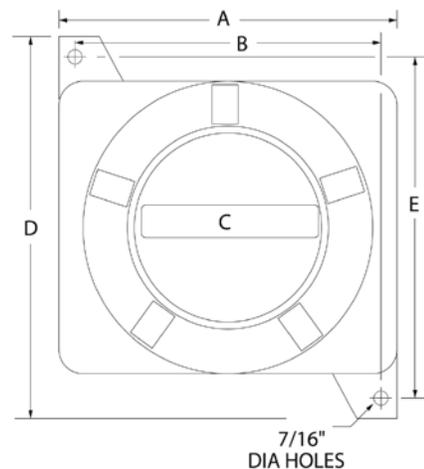

# Intrinsically Safe Intrinsic Safety Barriers

## Standard Features

- Each system features excitation, sense and signal barriers
- Available in an enclosure for external mounting or in a chassis mount version
- R Stahl® or equivalent barriers that are approved by Factory Mutual
- 9002 Dual Channel



## Specifications

### Part #31201:

+ Excitation 9001/01-158-390-101  
**Voltage Range:**  
 +12VDC  
**Internal Resistance:**  
 55 Ω  
**Open Circuit Voltage:**  
 15.7VDC  
**Short Circuit Current:**  
 390 mA  
**Classifications:**  
 FM approved, UL listed,  
 CSA certified, SA, CE marked

### Part #31202:

± Excitation 9002/10-187-270-001  
**Voltage Range:**  
 ±6VDC  
**Internal Resistance:**  
 46 Ω  
**Open Circuit Voltage:**  
 18.7VDC  
**Short Circuit Current:**  
 278.8 mA  
**Classifications:**  
 FM approved, UL listed,  
 CSA certified, SA, CE marked

### Part #31540:

+ Excitation 9001/01-083-442-10  
**Voltage Range:**  
 +6VDC  
**Internal Resistance:**  
 48 Ω  
**Open Circuit Voltage:**  
 8.4VDC  
**Short Circuit Current:**  
 442 mA  
**Classifications:**  
 FM approved, UL listed,  
 CSA certified, SA, CE marked

### Part #30263:

± Signal 9002/77-093-040-001  
**Voltage Range:**  
 ±6VDC  
**Internal Resistance:**  
 482 Ω  
**Open Circuit Voltage:**  
 9.6VDC  
**Short Circuit Current:**  
 40.9 mA  
**Classifications:**  
 FM approved, UL listed,  
 CSA certified, SA, CE marked

### Part #31542:

RS-232 9002/22-093-300-001  
**Voltage Range:**  
 ±6VDC  
**Internal Resistance:**  
 75.8 Ω  
**Open Circuit Voltage:**  
 9.6VDC  
**Short Circuit Current:**  
 297.5 mA  
**Classifications:**  
 FM approved, UL listed,  
 CSA certified, SA, CE marked

### Part #30264:

± Sense 9002/10-187-020-001  
**Voltage Range:**  
 ±6VDC  
**Internal Resistance:**  
 482 Ω  
**Open Circuit Voltage:**  
 18.7VDC  
**Short Circuit Current:**  
 22 mA  
**Classifications:**  
 FM approved, UL listed,  
 CSA certified, SA, CE marked

### Part #69491:

- Excitation 9001/02-016-150-111  
**Voltage Range:**  
 ±0.7VDC  
**Internal Resistance:**  
 12.8 Ω  
**Open Circuit Voltage:**  
 1.64VDC  
**Short Circuit Current:**  
 127.4 mA  
**Classifications:**  
 FM approved, UL listed,  
 CSA certified, SA, CE marked

### Part #69492:

+ Sense 9001/01-168-020-101  
**Voltage Range:**  
 ±12VDC  
**Internal Resistance:**  
 898 Ω  
**Open Circuit Voltage:**  
 16.8VDC  
**Short Circuit Current:**  
 18.7 mA  
**Classifications:**  
 FM approved, UL listed,  
 CSA certified, SA, CE marked

### Part #69493:

- Sense 9001/02-016-015-101  
**Voltage Range:**  
 +0.7VDC  
**Internal Resistance:**  
 127 Ω  
**Open Circuit Voltage:**  
 1.64VDC  
**Short Circuit Current:**  
 13.7 mA  
**Classifications:**  
 FM approved, UL listed,  
 CSA certified, SA, CE marked

### Part #70723:

- Excitation 9001/00-083-442-101  
**Voltage Range:**  
 -6VDC  
**Internal Resistance:**  
 26 Ω  
**Open Circuit Voltage:**  
 -8.4VDC  
**Short Circuit Current:**  
 442 mA  
**Classifications:**  
 FM approved, UL listed,  
 CSA certified, SA, CE marked

### Part #70724:

+ Sense 9001/01-086-020-101  
**Voltage Range:**  
 +6VDC  
**Internal Resistance:**  
 470 Ω  
**Open Circuit Voltage:**  
 8.6VDC  
**Short Circuit Current:**  
 18.3 mA  
**Classifications:**  
 FM approved, UL listed,  
 CSA certified, SA, CE marked

### Part #72396:

- Sense 9001/00-086-020-101  
**Voltage Range:**  
 +6VDC  
**Internal Resistance:**  
 480 Ω  
**Open Circuit Voltage:**  
 8.6VDC  
**Short Circuit Current:**  
 18.3 mA  
**Classifications:**  
 FM approved, UL listed,  
 CSA certified, SA, CE marked

### Part #30266:

- Excitation 9001/00-086-390-101  
**Voltage Range:**  
 -0.6VDC  
**Internal Resistance:**  
 30 Ω  
**Open Circuit Voltage:**  
 8.6VDC  
**Short Circuit Current:**  
 377.6 mA  
**Classifications:**  
 FM approved

### Part #72521:

- Excitation 9001/01-199-390-101  
**Voltage Range:**  
 +16VDC  
**Internal Resistance:**  
 67 Ω  
**Open Circuit Voltage:**  
 -19.9VDC  
**Short Circuit Current:**  
 382.7 mA  
**Classifications:**  
 FM approved, CSA certified,  
 CE marked

### Part #30265:

+ Excitation 9001/01-086-390-101  
**Voltage Range:**  
 +6VDC  
**Internal Resistance:**  
 30 Ω  
**Open Circuit Voltage:**  
 8.6VDC  
**Short Circuit Current:**  
 377.6 mA  
**Classifications:**  
 FM approved

Intrinsically Safe  
**Intrinsic Safety Barriers**

**Part Number/Price**

PART #	DESCRIPTION	EST. SHIP WEIGHT	PRICE
<b>Barrier Kit #1</b>			
For use with indicators that have ±5 Volt power supplies			
31202	9002/10-187-270-001, ± Excitation barrier	1 lb	\$450.00
30264	9002/10-187-020-001, ± Sense barrier	1 lb	475.00
30263	9002/77-093-040-001, ± Signal barrier	1 lb	475.00
<b>Barrier Kit #2:</b>			
For use with indicators that have ±5 Volt power supplies			
31540	9001/01-083-442-101, + Excitation barrier	1 lb	295.00
70723	9001/00-083-442-101, - Excitation barrier	1 lb	295.00
70724	9001/01-086-020-101, + Sense barrier	1 lb	295.00
72396	9001/00-086-020-101, - Sense barrier	1 lb	325.00
30263	9002/77-093-040-001, ± Signal barrier	1 lb	475.00
<b>Barrier Kit #3:</b>			
For use with indicators that have +10 Volt power supplies			
31201	9001/01-158-390-101, + Excitation barrier	1 lb	385.00
69491	9001/02-016-150-111, - Excitation barrier	1 lb	350.00
69492	9001/01-168-020-101, + Sense barrier	1 lb	325.00
69493	9001/002-016-015-101, - Sense barrier	1 lb	375.00
30263	9002/77-093-040-001, ± Signal barrier	1 lb	475.00
<b>Barrier Kit #4:</b>			
For use with indicators that have +5 Volt single sided Excitation supplies			
31540	9001/01-083-442-101, + Excitation barrier	1 lb	295.00
69491	9001/02-016-150-11, - Excitation barrier	1 lb	350.00
30263	9002/77-093-040-001, I Signal barrier	1 lb	475.00
If sense leads are needed, use the following:			
70724	9001/01-086-020-101, + Sense barrier	1 lb	295.00
69493	9001/002-016-015-101, - Sense barrier	1 lb	375.00
<b>Miscellaneous Barriers:</b>			
31201	9001/01-158-390-101, + Excitation barrier	1 lb	385.00
69491	9001/02-016-150-111, - Excitation barrier	1 lb	350.00
69492	9001/01-168-020-101, + Sense barrier	1 lb	325.00
69493	9001/002-016-015-101, - Sense barrier	1 lb	375.00
30263	9002/77-093-040-001, ± Signal barrier	1 lb	475.00
31542	9002/77-093-300-001, RS-232	1 lb	425.00
30266	9001/00-086-390-101, - Excitation barrier		325.00
30265	9001/01-086-390-101, + Excitation barrier		325.00
72521	9001-01-199-390-101, + Excitation barrier		425.00

**Options/Accessories:**

PART #	DESCRIPTION	PRICE
33531	DIN rail, 6 in length	\$5.00
35815	IS barrier installation manual	5.00
110424	FRP enclosure, up to 4 barriers (not included)	225.00
22828	Ground terminal block	15.00

Protocol Cards

**Profibus® DP Interface**

720i/820i/920i

**Specifications****720i™, 820i™ and 920i™ Power Requirements:**

Bus adapter card with DeviceNet Module, DC power  
 Supply voltage 6VDC, supplied by 920i bus  
 Typical current draw: 370 mA  
 Power consumption: 2.22W

**Operating Temperature:**

14°F to 104°F (-10°C to 40°C)

**Warranty:**

One-year limited warranty

**Standard Features**

- DP intelligent slave
- Standard GSD file on disk
- 128 selectable addresses
- Auto baud rate up to 56K
- Registered with Profibus Trade Organization



PN 68540

**Part Number/Price**

PART #	DESCRIPTION	EST. SHIP WEIGHT	PRICE
68540	Profibus DP interface kit (internal), for use with 720i/820i/920i	3 lb	\$650.00

*NOTE: Because Profibus DP option boards interface with programs written by non-RLWS parties, please consult factory for latest technical updates before quoting.*

**Options/Accessories**

PART #	DESCRIPTION	PRICE
73754	Additional GSD file	\$25.00
69948	Additional operating manual, (720i/820i/920i)	40.00

# Protocol Cards

## Profibus® DP Interface

### 880

### Specifications

**Dimensions:**

2.0 x 1.9 x 0.75 in  
(51.8 x 48 x 19.1 mm)

**Power Requirements:**

3.15-3.45VDC

**Operating Temperature:**

-40°F to 176°F (-40°C to 85°C)

**Warranty:**

One-year limited warranty

### Standard Features

- DP intelligent slave
- Standard GSD file on disk
- 100 selectable addresses
- Up to 12 mbps baud rate



PN 156556

### Part Number/Price

PART #	DESCRIPTION	EST. SHIP WEIGHT	PRICE
156556	Profibus DP interface kit, for use with 880 indicator	3 lb	\$550.00

### Options/Accessories

PART #	DESCRIPTION	PRICE
157941	Additional GSD file	\$25.00
156784	Additional operating manual, (880)	40.00

# Protocol Cards

## ProfiNet® Interface

880

### Specifications

**Dimensions:**

2 x 1.9 x 0.75 in (51.8 x 48 x 19.1 mm)

**Power Requirements:**

3.15-3.45VDC

**Operating Temperature:**

-40°F to 176°F (-40°C to 85°C)

**IP Address Range:**

Full IP address range DHCP

**Configuration:**

GSDML file

**Connector Type:**

RJ-45 (two with dual port version)

### Standard Features

- ProfiNet communication adapter
- Onboard diagnostic LEDs
- 100 mbps Baud Rate
- Works as an I/O device on the ProfiNet network
- PROFIenergy compliant



PN 156555

### Part Number/Price

PART #	DESCRIPTION	EST. SHIP WEIGHT	PRICE
156555	ProfiNet Interface kit for 880 (single port)	1 lb	\$550.00
156916	ProfiNet Interface kit for 880 (dual port)	1 lb	650.00

### Options/Accessories

PART #	DESCRIPTION	PRICE
157940	Additional Profinet CD	\$25.00
156781	Additional operating manual, (880)	40.00



# Allen-Bradley® Remote I/O

720i™/820i\*/920i\*

## Specifications

### 720i, 820i and 920i Electrical:

- DC power
- Supply voltage: 6VDC supplied by 720i, 820i and 920i bus
- Typical current draw: 137 mA
- Power consumption: 126 mA

### Communications:

- Twin axial cable attachment to network at 57.6, 115.2 or 230.4 Kbps
- Update rate is dependent on the configured baud rate and the number of network modes

### Operating Temperature:

- 14°F to 104°F (-10°C to 40°C)

### Warranty:

- One-year limited warranty

## Standard Features

- 115 or 230VAC operation
- Discrete data transfer
- Block data transfer



PN 68539

## Part Number/Price (Limited Supply)

PART #	DESCRIPTION	EST. SHIP WEIGHT	PRICE
68539	Allen-Bradley Remote I/O (internal), for use with 720i/820i/920i	3 lb	\$650.00

## Options/Accessories

PART #	DESCRIPTION	PRICE
36254	Additional operating manual, external version	\$35.00
69950	Additional operating manual, (720i/820i/920i)	35.00

*NOTE: Because A-B Remote I/O option boards interface with programs written by non-RLWS parties, please consult factory for latest technical updates before quoting.*

Protocol Cards

**DeviceNet™ Interface**

720i™/820i\*/920i\*

**Specifications****Power Requirements:**

Bus adapter card with DeviceNet Module, DC power  
 Supply voltage 6VDC, supplied by 720i, 820i and 920i bus  
 Typical current draw: 270 mA  
 Power consumption: 1.62W  
 The bus shall be supplied with 24V DC  
 ±10% on the fieldbus connector

**Field Bus Interface:**

Pluggable screw connector

**Operating Temperature:**

14°F to 104°F (-10°C to 40°C)

**Diagnostic Led:**

Network status, module status

**Communications:**

Twisted-pair cabling at 125, 250, or 500 Kbps  
 Update rate is dependent on the configured baud rate and the number of network modes

**Galvanic Isolation:**

Bus power is separated from other electronics via DC/DC converter. The send and receive signals are isolated via opto couplers

**Warranty:**

One-year limited warranty

**Standard Features**

- DeviceNet communication adapter
- Compact size for internal installation in 720i, 820i, and 920i\* indicators
- Polled I/O connection
- 125 Kbps, 250 Kbps, and 500 Kbps baud rate
- On-board LED diagnostics
- Floating-point commands support decimal points



PN 68541

**Part Number/Price**

PART #	DESCRIPTION	EST. SHIP WEIGHT	PRICE
68541	DeviceNet interface for use with 720i/820i/920i	3 lb	\$650.00

**Options/Accessories**

PART #	DESCRIPTION	PRICE
72779	Additional EDS CD	\$25.00
69949	Additional operating manual	40.00

Protocol Cards  
**DeviceNet™ Interface**  
880

### Specifications

**Dimensions:**

2 x 1.9 x 0.75 in  
(151.8 x 48 x 19.1 mm)

**Power Requirements:**

3.15-3.45VDC

**Operating Temperature:**

-40°F to 176°F (-40°C to 85°C)

**IP Address Range:**

MAC ID 0-63

**Connector Type:**

RJ-45 (two with dual port version)

### Standard Features

- DeviceNet communication adapter
- DIN Rail Mount for installation with 880
- 125 Kbps, 150 Kbps and 500 Kbps baud rate
- Onboard LEDs



PN 156558

### Part Number/Price

PART #	DESCRIPTION	EST. SHIP WEIGHT	PRICE
156558	DeviceNet interface for use with 880	1 lb	\$550.00

### Options/Accessories

PART #	DESCRIPTION	PRICE
157945	Additional EDS CD	\$25.00
156783	Additional operating manual (820i/920i)	40.00

Protocol Cards  
**ControlNet™ Interface**  
820i®/920i®

## Specifications

**Power Requirements:**

Supply voltage 6VDC, supplied by 820i, and 920i bus

**Field Bus Interface:**

BNC connector

**Operating Temperature**

14°F - 104°F (-10°C - 40°C)

**Diagnostic Leds:**

Tx/Rx data, good link, status, diagnostics

**Power Consumption:**

5V regulated, 350 mA

**Diagnostic Leds:**

Link status, module status, network status, activity

**Field Bus Interface:**

RJ-45

## Standard Features

- Option for 820i and 920i
- Polled I/O connection
- On-board LED diagnostics
- Floating-point commands support decimal points



PN 103136

## Part Number/Price

PART #	DESCRIPTION	PRICE
103136	ControlNet interface for use with 820i/920i	\$1,000.00
<b>Cables</b>		
Consult factory for coaxial cable with cord grips		

## Options/Accessories

PART #	DESCRIPTION	PRICE
104828	Additional ControlNetCD	\$25.00
103122	Additional operating manual (820i/920i)	40.00

Protocol Cards  
**MODBUS-TCP® Interface**  
 880

**Specifications**

**Dimensions:**

2.0 x 1.9 x 0.75 in  
 (151.8 x 48 x 19.1 mm)

**Power Requirements:**

3.15-3.45VDC

**Operating Temperature:**

-40°F to 176°F (-40°C to 85°C)

**Relative Humidity:**

5-95% non condensation

**Connector Type:**

RJ-45 (two with dual port version)

**Standard Features**

- Active module with serial and parallel application interface
- Complete Modbus-TCP server
- Up to Eight Bytes of I/O data in each direction
- Transformer isolated interface 100 Mbps full duplex Ethernet
- Onboard diagnostic LEDs
- CE and UL Compliant



PN 156557

**Part Number/Price**

PART #	DESCRIPTION	EST. SHIP WEIGHT	PRICE
156557	Modbus-TCP Interface kit for 880 (single port)	1 lb	\$550.00
156917	Modbus-TCP Interface kit for 880 (dual port)	1 lb	650.00

**Options/Accessories**

PART #	DESCRIPTION	PRICE
157399	Additional Modbus-TCP CD	\$25.00
156782	Additional operating manual (880)	40.00

## Protocol Cards

**EtherNet/IP® Protocol Card for AB PLC**

720i™/820i®/920i®

**Specifications****Physical Specifications:**

Length: 2.13 in (86 mm)

Width: 3.38 in (54 mm)

Height: 0.59 in (15 mm)

**Power Requirements:**

+5VDC ± 5%, powered by indicator

**Power Consumption:**

350 mA on the 5V power connection

**Operating Temperature:**

14°F to 158°F (-10°C to 70°C)

**Non-Operating Temperature:**

-13°F to 185°F (-25°C to 85°C)

**Relative Humidity:**

5 - 95% non-condensing

**Diagnostic Leds:**

Link status, module status, network status, activity

**Field Bus Interface:**

RJ- 45

**Standard Features**

- Industrial Protocol for AB PLC
- IP address settings configurable with on-board DIP switched, Web page, or ARP or DHCP
- Supports Rockwell Automation® EtherNet/IP level
- CE marked and UL conformance
- Onboard diagnostic LED

**Control Protocols**

- Supports the Modbus/TCP protocol and conforms to Modbus/TCP specification 1.0

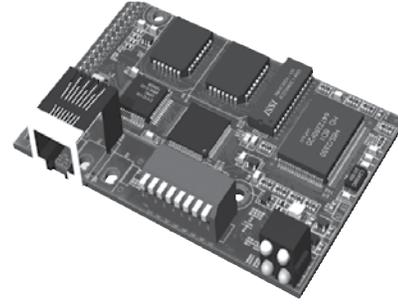

PN 87803

**Part Number/Price**

PART #	DESCRIPTION	PRICE
87803	EtherNet/IP Protocol Card for 720i/820i/920i	\$800.00

**Options/Accessories**

PART #	DESCRIPTION	PRICE
72763	Additional EtherNet/IP CD	\$25.00
88537	Additional operating manual	40.00

Protocol Cards  
**EtherNet/IP® for AB PLC**  
 880

## Specifications

**Dimensions:**

2 x 1.9 x 0.75 in  
 (151.8 x 48 x 19.1 mm)

**Power Requirements:**

3.15-3.45VDC

**Operating Temperature:**

-40°F to 176°F (-40°C to 85°C)

**Relative Humidity:**

5-95% non condensation

**Address Range:**

Full IP address range

## Standard Features

- Industrial Protocol for AB PLC
- IP address settings configurable with web page, ARP or DHCP
- Supports Rockwell Automation EtherNet/IP
- Diagnostic LEDs
- CE marked and UL conformance



PN 156554

## APPROVALS



## Part Number/Price

PART #	DESCRIPTION	EST. SHIP WEIGHT	PRICE
156554	EtherNet/IP Interface kit for 880 (single port)	1 lb	\$550.00
156915	EtherNet/IP Interface kit for 880 (dual port)	1 lb	650.00

## Options/Accessories

PART #	DESCRIPTION	PRICE
157943	Additional EtherNet/IP CD	\$25.00
156861	Additional operating manual (880)	40.00

# Protocol Cards

## Ethernet TCP/IP Interface

720i™/820i®/920i®

### Specifications

**Supported Protocols:**

ARP, UDP, TCP, Telnet, SNMP, ICMP, HTTP, BOOTP, DHCP, and TFTP

**Compatibility:**

Ethernet: Version 2.0/IEEE 802.3

**Network Interface:**

Ethernet: RJ-45 (10/100 Base-T) or AUI  
(transformer and resistors/capacitors required)

**Serial Interface:**

1 serial interface

**Reset line:**

RxD/TxD  
RTS/CTS/DCD  
DTR line (for disconnect)  
Three status lines (for LEDs)

**Data Rates:**

300 bps to 115.2 Kbps

**Serial Line Formats:**

Characters: seven or eight data bits  
Stop bits: one or two  
Parity: odd, even, none

**Modem Controls:**

DTR (TTL level)

**Flow Control:**

XON/XOFF  
CTS/RTS  
None

**Management:**

SNMP (read only)  
Serial login, Telnet login

**Diagnostic LEDs:**

TX/RX Data  
Good Link  
Status  
Diagnostics

**Power Requirements:**

5V regulated  
250 mA (Ethernet model)

**Operating Temperature:**

41°F to 122°F (5°C to 50°C)



PN 71986

### Part Number/Price

PART #	DESCRIPTION	EST. SHIP WEIGHT	PRICE
71986	Ethernet TCP/IP Interface for use with 720i/820i/920i	3 lb	\$400.00
98057	Wireless Ethernet TCP/IP interface for use with 720i, 820i and 920i	3 lb	650.00

### Options/Accessories

PART #	DESCRIPTION	PRICE
72763	Ethernet CD	\$25.00
72117	Additional operating manual	10.00
<b>Cables</b>		
72697	RJ-45 to RJ-45, straight	35.00
78860	RJ-45 to RJ-45, cross over	35.00

### Standard Features

- Supports any serial devices with seven or eight data requiring Ethernet access
- Compact size for internal installation in 720i™, 820i® and 920i® indicators
- Can be used in other applications requiring five-volt power supplied
- 10/100 megabyte through RJ-45 connector or wireless option
- HTTP, serial, telnet, and SNMP management



# TranSend™

## Wireless Load Cell Interface System

### Standard Features

- Works with any basic digital weight indicator
- Excitation to load cell(s) provided by the transmitter, not the indicator
- Each transmitter/receiver set is individually paired and will not interfere with another set
- Auto-off mode - selectable for 15, 30, 45, 60 minutes or off
- Auto-sleep mode - power down during non-use, power up with weight change, or key press

### Specifications

**Power:**

5-6VDC, 7-36VDC  
85-265VAC

**Excitation Voltage:**

Transmitter: +4.8VDC, 16x 350Ω or  
32x 700Ω load cells

**Standard Antenna:**

1/2 wave 2dBi, articulated

**Frequency:**

Direct sequence spread spectrum at 2.4 GHz, 802.15.4 license free

**Effective Range:**

100 ft or more

**Digital I/O:**

Three coil relays available on select models

**Circuit Protection:**

RFI, EMI, ESD protection

**Serial Port:**

Full duplex RS-232

**Operating Temperature:**

-40°F to 185°F (-40°C to 85°C)

**Enclosure:**

NEMA4/IP66, aluminum black powder coated  
(excludes wall cube model)

**Warranty:**

Two-year limited warranty



### Part Number/Price

PART #	DESCRIPTION	EST. SHIP WEIGHT	PRICE
<b>TRANSMITTERS</b>			
<b>5-6 VDC Power Input</b>			
160330	Single-channel transmitter, no relays. RF 802.15.4, 2.4 GHz	2 lb	\$775.00
159207	Four-channel transmitter, no relays. RF 802.15.4, 2.4 GHz	2 lb	825.00
161949	Four-channel transmitter, includes three coil relays. RF 802.15.4, 2.4 GHz	2 lb	950.00
<b>7-36 VDC Power Input</b>			
160329	Single-channel transmitter, no relays. RF 802.15.4, 2.4 GHz	2 lb	825.00
159470	Four-channel transmitter, no relays. RF 802.15.4, 2.4 GHz	2 lb	850.00
161951	Four-channel transmitter, includes three coil relays. RF 802.15.4, 2.4 GHz	2 lb	995.00
<b>85-265 VAC Power Input</b>			
160328	Single-channel transmitter, no relays. RF 802.15.4, 2.4 GHz	2 lb	850.00
159469	Four-channel transmitter, no relays. RF 802.15.4, 2.4 GHz	2 lb	875.00
161950	Four-channel transmitter, includes three coil relays. RF 802.15.4, 2.4 GHz	2 lb	1,025.00
<b>RECEIVERS</b>			
<b>5-6 VDC Power Input</b>			
160337	Receiver to provide a mV signal to a digital weight indicator. RF 802.15.4, 2.4GHz	2 lb	875.00
160334	Receiver to provide an analog output signal: 4-20 mA, 0-20 mA, 0-5VDC, 0-10VDC, +/- 5VDC, +/- 10VDC. RF 802.15.4, 2.4 GHz	2 lb	925.00
160016	Receiver to provide an analog output signal: 4-20 mA, 0-20 mA, 0-5VDC, 0-10VDC, +/- 5VDC, +/- 10VDC. Includes three coil relays. RF 802.15.4, 2.4 GHz	2 lb	1,050.00
<b>7-36 VDC Power Input</b>			
160336	Receiver to provide a mV signal to a digital weight indicator. RF 802.15.4, 2.4GHz	2 lb	950.00
160333	Receiver to provide an analog output signal: 4-20 mA, 0-20 mA, 0-5VDC, 0-10VDC, +/- 5VDC, +/- 10VDC. RF 802.15.4, 2.4 GHz	2 lb	1,050.00
159476	Receiver to provide an analog output signal: 4-20 mA, 0-20 mA, 0-5VDC, 0-10VDC, +/- 5VDC, +/- 10VDC. Includes three coil relays. RF 802.15.4, 2.4 GHz	2 lb	1,175.00
<b>85-265 VAC Power Input</b>			
160335	Receiver to provide a mV signal to a digital weight indicator. RF 802.15.4, 2.4GHz	2 lb	995.00
160332	Receiver to provide an analog output signal: 4-20 mA, 0-20 mA, 0-5VDC, 0-10VDC, +/- 5VDC, +/- 10VDC. RF 802.15.4, 2.4 GHz	2 lb	1,100.00
159475	Receiver to provide an analog output signal: 4-20 mA, 0-20 mA, 0-5VDC, 0-10VDC, +/- 5VDC, +/- 10VDC. Includes three coil relays. RF 802.15.4, 2.4 GHz	2 lb	1,275.00

### Options/Accessories

PART #	DESCRIPTION	PRICE
162172	Charger, TranSend for 6V SLA battery	\$50.00
162173	Battery, TranSend 6V SLA	95.00
162175	Enclosure, TranSend for 6V SLA battery	280.00
150964	RS-232 13 ft (4 m) serial cable with 9-Pin (female) connector	100.00
150965	RS-232 13 ft (4 m) serial cable with 9-Pin (male) connector	100.00
160110	AC adapter, TranSend (INTL) 6V	40.00
162178	Antenna kit, remote standard antenna	250.00
139309	Antenna kit, long range Omni with 3M coax	405.00
139310	Antenna kit, corner reflector 9 dbi with 3M coax	Consult
139311	Antenna kit, corner reflector 12 dbi with 3M coax	Consult
139312	Antenna kit, Yagi 15 dbi with 3M coax	Consult
144345	30 M coaxial cable, for use with non-vehicle mount antenna kits	375.00
139313	Antenna kit, vehicle mount. 5 dbi with 5 M coaxial cable	Consult
162177	Cordset, TranSend. Pre-wired for use with single channel transmitters or non-relay based receivers	100.00
162184	Load cell connector, TranSend. Field wireable, 4-6 mm straight. For use with single channel transmitters	45.00
162185	Load cell connector, TranSend. Field wireable, 6-8 mm straight. For use with single channel transmitters	45.00
162186	Load cell connector, TranSend. Field wireable, 4-6 mm right angle. For use with single channel transmitters	45.00
162187	Load cell connector, TranSend. Field wireable, 6-8 mm right angle. For use with single channel transmitters	45.00

# SendIt™ Wireless Load Cell Interface System

## Specifications

**Power:**

5-6VDC,

**Excitation Voltage:**

Transmitter: +4.8VDC, 16x 350Ω or 32x 700Ω load cells

**Standard Antenna:**

1/2 wave 2dBi, articulated

**Frequency:**

Direct sequence spread spectrum at 2.4 GHz, 802.15.4 license free

**Effective Range:**

100 ft or more

**Circuit Protection:**

RFI, EMI, ESD protection

**Serial Port:**

Full duplex RS-232

**Operating Temperature:**

-40°F to 185°F (-40°C to 85°C)

**Enclosure:**

NEMA4 (IP66), aluminum black powder coated (excludes wall cube model)

**Warranty:**

Two-year limited warranty

## Standard Features

- Works with any basic digital weight indicator
- Excitation to load cell(s) provided by the transmitter, not the indicator
- Each transmitter/receiver set is individually paired and will not interfere with another set
- Auto-off mode - selectable for 15, 30, 45, 60 minutes or off
- Auto-sleep mode - power down during non-use, power up with weight change, or key press



## Part Number/Price

PART #	DESCRIPTION	EST. SHIP WEIGHT	PRICE
<b>TRANSMITTERS</b>			
<b>5-6 VDC Power Input</b>			
160331	Single-channel transmitter, 5-6 VDC no relays. RF 802.15.4, 2.4 GHz 5-6 VDC	2 lb	\$750.00
<b>RECEIVERS</b>			
<b>5-6 VDC Power Input</b>			
160338	Receiver to provide a mV signal to a digital weight indicator. RF 802.15.4, 2.4GHz 5-6 VDC Power Unit	2 lb	825.00
<b>PAIRED SET</b>			
<b>5-6 VDC Power Input</b>			
165312	Includes one single channel transmitter and one receiver, paired. Includes a 2 m load cell cable and 2 m indicator cable/ power source sold separately	5 lb	1,650.00

## Options/Accessories

PART #	DESCRIPTION	PRICE
162172	Charger, SendIt 6V SLA battery	\$50.00
162173	Battery, SendIt 6V SLA	95.00
162175	Enclosure, SendIt for 6V SLA battery	280.00
150964	RS-232 13 ft (4 m) serial cable with 9-Pin (female) connector	100.00
150965	RS-232 13 ft (4 m) serial cable with 9-Pin (male) connector	100.00
160109	AC adapter, SendIt 6V	40.00
162177	Cordset. Pre-wired for use with single channel transmitters or non-relay based receivers	100.00
162184	Load cell connector. Field wireable, 4-6 mm straight. For use with single channel transmitters	45.00
162185	Load cell connector. Field wireable, 6-8 mm straight. For use with single channel transmitters	45.00
162186	Load cell connector. Field wireable, 4-6 mm right angle. For use with single channel transmitters	45.00
162187	Load cell connector. Field wireable, 6-8 mm right angle. For use with single channel transmitters	45.00
162178	Antenna kit, remote standard antenna	250.00
139309	Antenna kit, long range Omni with 3M coax	405.00
139310	Antenna kit, corner reflector 9 dbi with 3M coax	Consult
139311	Antenna kit, corner reflector 12 dbi with 3M coax	Consult
139312	Antenna kit, Yagi 15 dbi with 3M coax	Consult

## Specifications

**Frequency Band:**

902-928 MHz

**Modulation:**

FHSS FSK

**Interface:**

Standard: RS232 (DB9 Male)

ConnexLink PRO: RS485 (6-Pin terminal block)

**Serial Interface Data Rate:**

up to 115200 kbps

**Output Power:**

5 mW-1000 mW variable

**Input Power:**

7 Vdc-18 Vdc

**Current Draw (at 12 VDC):**

400 mA TXD, 40 mA RXD

**Power Supply:**

AC transformer via 6 ft cable (183 cm)

**Electrical Requirements:**

Line voltage 100-120V; frequency 50-60 Hz (240V outside the US)

**Channels:**

Up to 32

Security:

1-byte system ID, DES

**Sensitivity:**

-99dB at full RF data rate

**Range (line-of-sight):**

Up to 20 miles (32 km)

**Temperature:**

-40°F to 176°F (-40°C to 80°C)

**Humidity (non-condensing):**

10% to 90%

**Weight:**

&lt;6 oz (&lt;170 g)

**Dimensions:**

4.75 x 2.75 x 1.17 in (121 x 70 x 30 mm)

**Antenna Connector:**

Reverse polarity SMA jack (female)

When operating multiple sets of ConnexLinks radios in range of each other, "Sync To Channel" must be configured so that the multiple Servers stay in sync with each other to guarantee that data is never transmitted on the same frequency. The first server needs to be set to Channel 16 and the remaining Server(s) need to be set to different channels. Make sure the Clients match their respective Servers with channel # and System ID #.

Sync to Channel must be enabled on all Servers that have a channel number greater than 16. No other configuration modifications are required for the Clients. In order to enable "Sync To Channel" user will be required to download the latest software at:

[http://www.aerocomm.com/rf\\_documents\\_software/lock\\_software.htm](http://www.aerocomm.com/rf_documents_software/lock_software.htm), then select Development Kit Software.

Once downloaded, launch the software and select "PC Settings." In the Product Field select Connex4490. Also select the appropriate COM port and Baud Rate. Click the About button and left-click the cursor. Type "showframe," then Enter. Your typing will not appear in the window. Click OK and select Show All Options. Click on the configure tab and follow the directions on the screen.



Wireless Network

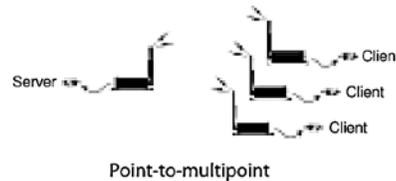
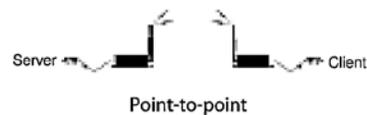

## Standard Features

- Durable industrial-grade enclosure with mounting flanges
- Transmits around corners and through walls
- Reliable communications up to 115200 kbps
- Supports point-to-point and point-to-multipoint applications

## Part Number/Price

PART #	DESCRIPTION	PRICE
86134	ConnexLink RF device 900MHz RF device server/client (requires minimum of two)	\$325.00
105776	ConnexLink Pro 900MHz 1W, wireless transceiver with large buffer	395.00
129662	Paired ConnexLink	650.00

## Options/Accessories

PART #	DESCRIPTION	PRICE
78827	Power supply, 115 VAC input/6 VDC output	\$55.00
103979	Antenna 1/2 Wave, 2 dBi, 7 in for 900MHz radios	45.00
119448	Yagi antenna	105.00
119449	Cable, Yagi antenna 20 ft	75.00
110538	ConnexLink FRP enclosure with heater	1,395.00
110539	ConnexLink Pro enclosure with heater	1,395.00
22436	RS-232 9-Pin female to blunt end	55.00
98084	DC power cable option	15.00

# RF Transceivers

## Industrial Broadband Wireless Ethernet

### Specifications

**Frequency Band (varies by country):**

- 2.412 GHz to 2.462 GHz (FCC)
- 2.412 GHz to 2.472 GHz (ETSI)
- 5.150 GHz to 5.250 GHz (FCC/ETSI)
- 5.725 GHz to 5.850 GHz (FCC)

**Wireless Standards:**

802.11a, 802.11b, 802.11g and 802.11i

**Transmit Power; Programmable (varies by country):**

- 2.4 GHz: up to 100 mW (20 dBm)
- 5 GHz: up to 64 mW (18 dBm)

**Channel Data Rates (modulation):**

802.11b, 11, 5.5, 2, 1 Mbps (DSSS, BPSK, QPSK, CCK) 802.11g: 54, 48, 36, 24, 18, 12, 9, 6 Mbps (OFDM) 802.11a: 54, 48, 36, 24, 18, 9, 6 Mbps (OFDM)

**Receiver Sensitivity (Typical):**

- 90 dBm at 1 Mbps
- 85 dBm at 11 Mbps
- 82 dBm at 24 Mbps
- 75 dBm at 54 Mbps

**Channels Selection (varies by country):**

1 to 13 (802.11a)

**Security:**

WPA2 - 802.11i with 128 bit AES-CCM legacy WPA TKIP, WEP support MAC ID filter, admin password



### Standard Features

- Serial and Ethernet connectivity
- Configures as 802.11 abg Access Point, Wireless Bridge, Wireless Repeater and Client
- Secure WPA2/128 bit encryption
- Dual band 2.4 GHz or 5 GHz bands
- Robust design for extreme temperatures (-40° to 75°C) high vibration/shock and hazardous locations (UL Class 1, division 2 Atex Zone 2)\*

### Part Number/Price

PART #	DESCRIPTION	PRICE
161936	Industrial hot spot, 802.11abg	\$1,195.00
161954	Industrial hot spot in FRP enclosure	2,245.00
161955	Paired radios for serial data tunneling	2,390.00

\*Special ordered power supplies and antennas required

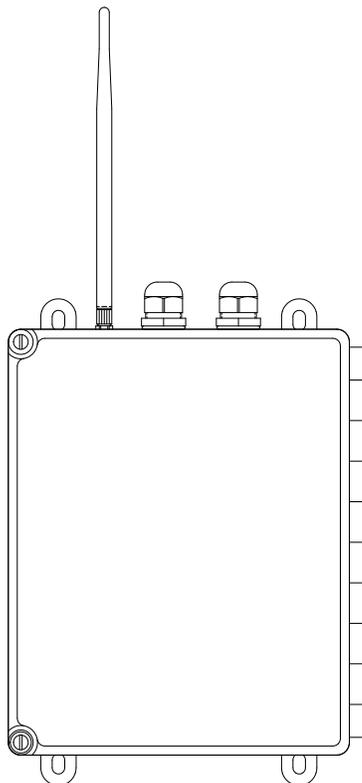

# RF Transceivers XTend-PKGTM RF Modems

## Specifications

### Connection Options:

- RS-232/422/485, DB-9 (XTend PKG-R)
- USB (XTend PKG-U)
- RS-232/422/482, DB-9/screw terminal (XTend PKG-NEMA)

### Dimensions:

- XTend PKG-R/PKG-U:
  - Length: 2.75 in (6.99 cm)
  - Width: 5.50 in (13.97 cm)
  - Depth: 1.13 in (2.86 cm)
  - Weight: 7.10 oz (200 g)
- XTend NEMA:
  - Length: 5.13 in (13.02 cm)
  - Width: 7.13 in (18.10 cm)
  - Depth: 1.50 in (3.81 cm)
  - Weight: 12.30 oz (348.70 g)

### Environmental:

- XTend PKG-R/NEMA -40oC to 85oC (industrial)
- XTend PKG-U 0oC to 70oC (commercial)

### Power Requirements:

- XTend PKG-R
  - Receive current: 110mA
  - Power supply voltage: 7-28V
  - Pin sleep power-down: 17mA
  - Serial port sleep down: 45 mA
  - Idle current: 19-39 mA
  - Transmit current: 110 - 900 mA
- XTend PKG-U
  - Receive current: 110mA (self power)
  - Power supply voltage: 7-28V
  - Pin sleep power-down: 17mA
  - Serial port sleep down: 45 mA
  - Idle current: 21-35 mA (self power)
  - Transmit current: 88-480 mA
- XTend NEMA
  - Receive current: 100mA
  - Power supply voltage: 7-28V
  - Pin sleep power-down: 17mA
  - Serial port sleep down: 45 mA
  - Idle current: 19-39 mA (self power)
  - Transmit current: 110-900 mA

### Antenna:

- XTend PKG-R/PKG-U
  - Connector: RPSMA (Reverse Polarity SMA)
  - Impedance: 50 ohms unbalanced
- XTend NEMA - weatherproof
  - External antenna version:
    - Connector: RPTNC
    - Impedance: 50 ohms unbalanced
  - Internal antenna version:
    - Connector: MMCX
    - Impedance: 50 ohms unbalanced

### Certifications:

- XTend PKG-R/PKG-U
  - FCC part 15.247: OUR-9XTEND
  - Industry Canada (IC): 4214A-9XTEND
- XTend NEMA
  - FCC part 15.247: OUR-9XTEND
  - Industry Canada (IC): 4214A-9XTEND
- IP66/67, IP66
- IK 08
- NEMA 1, 4, 4X, 6 (12 and 13)
- UL 94-5V, UL 508



## Specifications Continued

### Networking and Security:

- Frequency: ISM 902 MHz
- Spread spectrum: FHSS (Frequency Hopping Spread Spectrum)
- Modulation: FSK (Frequency Shift Keying)
- Supported Network Topologies:
  - Peer to peer (no master/slave dependencies)
  - point-to-point, point-to-multipoint and multidrop
- Channel capacity: 10 hop sequences share 50 frequencies
- Encryption: 256-bit AES Encryption
- AES algorithm meets Federal Information Processing Standard-197 (FIPS-197)

## Standard Features

- Indoor/urban range up to 3000 feet
- Outdoor line-of-sight range up to 40 miles (with high gain antenna)
- Outdoor line-of-sight range up to 14 miles (with 2.1 dB dipole antenna)
- Outstanding receiver sensitivity (-110 dBm at 9600 bps)
- Adjustable power output from 1mW to 1 W; up to 4 W EIRP (with 6 dB antenna)
- Interface data rate: 10 - 230,400 bps (including non-standard baud rates)
- Throughput data rate (software selectable) 9,600 or 115,200 bps
- FR data rate: 10,000 bps at 9,600 throughput data rate 125,000 bps at 115,200 bps
- Low power consumption for power-sensitive applications (Pin, serial port and cyclic sleep modes available)
- Streaming, acknowledged and multi-transmit modes supported
- Easy out of the box operation (no configuration necessary)
- Durable industrial grade enclosure

## Part Number/Price

PART #	DESCRIPTION	PRICE
112979	XTend-PKG RF Modem	\$895.00
Package includes one radio, antenna, & power supply		

# QWERTY Style Keyboards and Aluminum Keypads

## For Use With:

- Any system using RS-232 communications
- Kiosk systems
- 920i with custom software
- 720i, 820i control systems



## Visible Lights and Audible Alarms



## Din Rail Transient Protector & Fuse

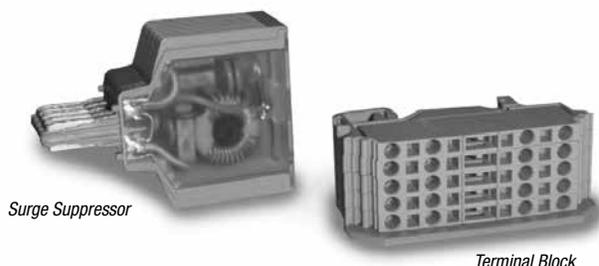

## EL226 Transient Protection Board

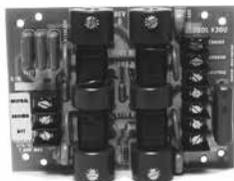

- Protects sensitive microprocessor-based equipment against spikes and short-duration surges while providing RFI/EMI protection
- Consult factory for standard features

## Manual Pushbuttons/Pushbutton Switches



- Key switches
- Lighted pushbuttons
- Pilot lights
- 2- and 3-position switches
- Colored pushbuttons
- Emergency stop mushroom switches
- Custom legend plates

## Part Number/Price

PART #	DESCRIPTION	PRICE
99149	Waterproof 80-key flexible keyboard USB	\$135.00
36914	Vandal-proof cast aluminum keypad*	155.00
38472	Keypad encoder	405.00
<b>Visible Lights and Audible Alarms</b>		
22838	Buzzer, 80 dB, steady	135.00
22839	Buzzer, 80 dB, pulse	135.00
156106	Buzzer box, 115 VAC, FRP enclosure	545.00
43931	Strobe lights, red	155.00
43930	Strobe lights, amber	155.00
43929	Strobe lights, blue	155.00
<b>Din Rail Transient Protector and Fuse</b>		
62965	Terminal Block	25.00
53895	Surge Suppressor	205.00
<b>Manual Pushbuttons/Pushbutton Switches</b>		
N/A	Operator and contact block combinations	starting at 12.00

# X-Purge

## Options/Accessories

- Vents
- Explosion-proof audible alarm
- Explosion-proof strobe light
- Fittings
- Tubing
- Operational bypass switch
- Rapid Exchange® purging technology

Many custom panels can utilize purge technology to bring high-level control to hazardous areas. Call a Rice Lake Sales Engineer for more information.



# Z-Purge

## Options/Accessories

- Vents
- Explosion-proof audible alarm
- Explosion-proof strobe light
- Fittings
- Tubing

Many custom panels can utilize purge technology to bring high-level control to hazardous areas. Call a Rice Lake Sales Engineer for more information.



Explosion-proof audible alarm



Explosion-proof strobe light



Vent



Industrial Control Products  
**Tripp-Lite USB to Serial Converters**  
 Serial Adapters

**Specifications**

**Data Transfer Rate:**  
 More than 500 kbps

**LED:**  
 Data transfer/handshaking (orange)

**Power Consumption:**  
 450 mW

**USB Specification:**  
 V1.1 compliant



**Standard Features**

- Portable design—no AC power required
- Simple plug-and-play setup
- Supports data transfer rates of more than 500 kbps
- Hot swappable

**Part Number/Price**

PART #	DESCRIPTION	WEIGHT	PRICE
153603	USB to Serial Converter	1 lb	\$85.00
22436	Cable DB9F to blunt end, 6 ft		55.00

**DB-9 PIN ASSIGNMENTS:**

PIN	Assignment
1	CD
2	RXD
3	TXD
4	DTR
5	GND
6	DSR
7	RTS
8	CTS
9	RI

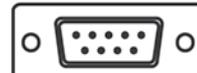

DB9 (Male) Connector

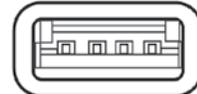

Type A USB Connector

Industrial Control Products  
**437 Bridgesensor**  
 Signal Conditioner

INDICATORS / CONTROLLERS

**Specifications**

**Output Current Span:**  
 4 to 20 mA; 0 to 20 mA

**Input for 16 mA Span:**  
 3 mV to 62 mV

**Zero Adjust:**  
 12 mA

**Amplifier:**  
 Cell sensitivity (10 volts excitation):  
 0.3 mV/V to 6.2 mV/V

**Output:**  
 Current: 0 to 20 mA

**Bridge Excitation Supply:**  
 Adjustment range: 5 to 15 Volts

**Power Requirements:**  
 Input Voltage: 10 to 36 Volts DC  
 Input current with 150 mA B+ load: 0.17A at 36V to 0.7A at 10V  
 Input current with one 350 Ω bridge: 0.1A at 36V to 0.35A at 10V

**Operating Temperature Range:**  
 -13°F to 131°F (-25°C to 55°C)

**Packaging:**  
 Epoxy potted plastic enclosure with exposed screw terminal connections

**Weight:**  
 2 lb (0.9 kg)

**Warranty:**  
 One-year limited warranty



**Standard Features**

- Complete strain gauge bridge signal conditioner
- 4-20 mA or 0-20 mA output
- Output capable of driving 1000 Ohms loop
- Bridge balance with 68% tare offset capability
- High gain amplifier; can accept live load signals as low as 3 mV and provide 16 mA output span
- Sufficient excitation current for five load cells
- Powered by 10 to 36VDC unregulated
- Rugged epoxy encapsulated design

**Part Number/Price**

PART #	DESCRIPTION	EST. SHIP WEIGHT	PRICE
46719	437 Bridgesensor, 4-20 mA/0-20 mA, 10-36VDC	2 lb	\$715.00

**437 Electrical Connections**

SCREW TERMINAL	FUNCTION	SCREW TERMINAL	FUNCTION
1	+DC Power	6	+ Excitation
2	-DC Power	7	Current Output
3	-Sense	8	Amplifier CMN
4	-Excitation	9	-Input
5	+Sense	10	+Input

CASE DIMENSIONS:

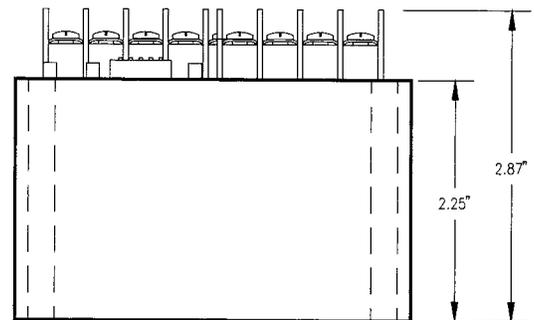
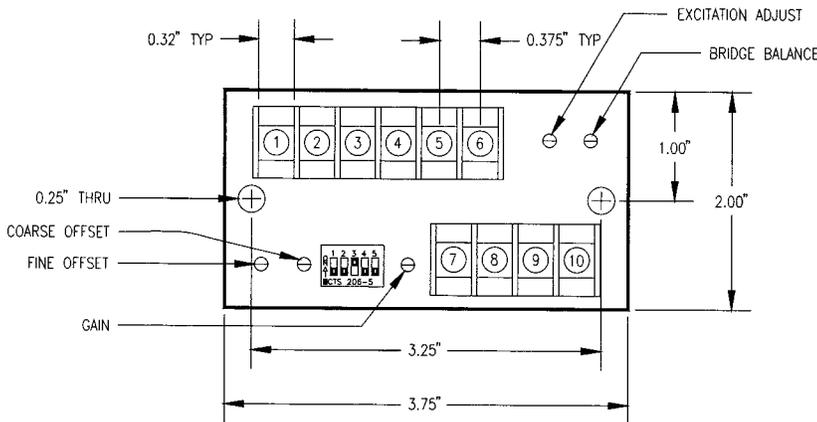

www.ricelake.com | Phone: 800-472-6703

**RICE LAKE**

Industrial Control Products  
**463 Bridgesensor**  
 Signal Conditioner

**Specifications**

**Input for 10V Output:**  
 5 mV to 50 mV

**Tare Adjustment Range:**  
 Bridge balance: -3 mV to +25 mV  
 Referred to input: Equals 80% F.S. of 3 mV/V to +25 mV/V

**Zero Adjust:**  
 0 or +2 Volts

**Output Voltage Range:**  
 -3 to +10 Volts

**Bridge Supply:**  
 Voltage adjustment range: 5 to 10 Volts

**Load Current:**  
 0 to 120 mA

**Operating Temperature Range:**  
 -13°F to 131°F (-25°C to 55°C)

**Packaging:**  
 Epoxy potted plastic enclosure with exposed screw terminal connections

**Weight:**  
 18 oz (510 g)

**Warranty:**  
 One-year limited warranty



**Standard Features**

- Complete strain gauge bridge signal conditioner
- Isolated 10 volt output
- Bridge balance with 80% tare offset capability
- Excitation supply capable of driving four load cells
- AC powered
- Rugged epoxy encapsulated design

**Part Number/Price**

PART #	DESCRIPTION	EST. SHIP WEIGHT	PRICE
46720	463 Bridgesensor, 0-10VDC, 115 VAC	2 lb	\$715.00

SCREW TERMINAL	FUNCTION	SCREW TERMINAL	FUNCTION
1	-Sense	6	AC
2	-Excitation	7	+Signal
3	+Sense	8	-Signal
4	+Excitation	9	Output
5	AC	10	Common

CASE DIMENSIONS:

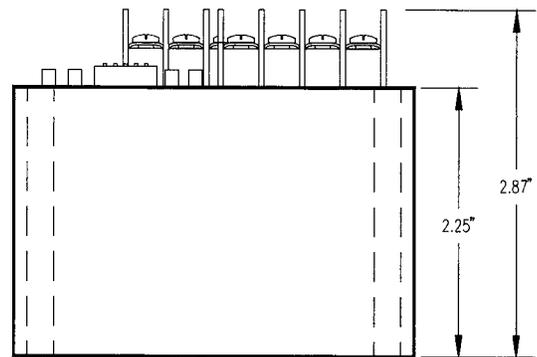
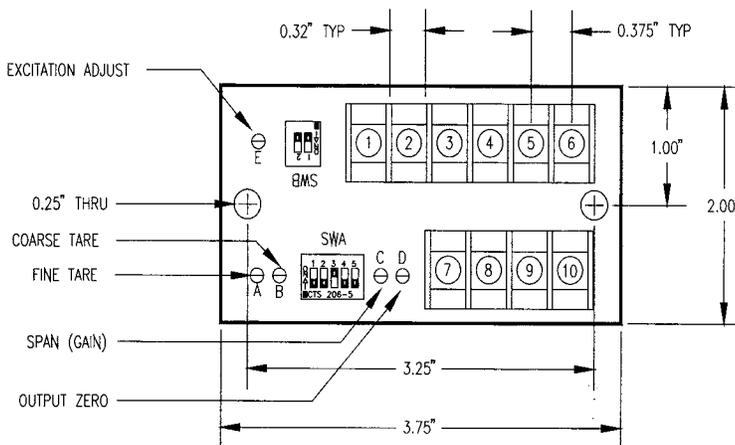

Industrial Control Products  
**API 4058G - 441/442 Bridgesensors**  
 Load Cell Signal Conditioners

## Bridgesensor 441/442 Specifications

**Input/Output Ranges:**

See table on next page. Other switch-selectable ranges possible.

**Input Impedance:**

200K ohm typical

**Output Capability:**

Voltage:  $\pm 10$ VDC; at  $\pm 10$  mA  
 Current: 25 mA DC; 20V compliance

**Zero/Span Controls:**

Top-accessible, multi-turn, non-interactive  
 Range:  $\pm 15\%$  of span typical

**Excitation:**

Switch-selectable, 0-10VDC in 1 Volt increments  
 Fine adjust:  $\pm 5\%$  via multi-turn potentiometer  
 Excitation Current Capability:  
 120 mA DC at 10VDC excitation; drives up to four 350-ohm load cells at 10VDC

**Excitation Stability:**

$\pm 0.1\%$  per degree Celsius

**Response Time:**

70 mS standard; faster responses available

**Sense Lead Compensation:**

Better than 0.01% per 1 ohm change in leadwire resistance

**Leadwire Resistance:**

10 ohm max for 10VDC excitation/350-ohm bridge

**Common Mode Rejection:**

100 dB minimum

**Isolation:**

2000V RMS minimum

**Operating Temperature Range:**

14°F to 140°F (-10°C to 60°C)

**Power:**

441: 115VAC,  $\pm 10\%$ , 50/60 Hz, 2.5W max  
 441 Optional: 230VAC,  $\pm 10\%$ , 50/60 Hz, 2.5W max  
 442: 9-30VDC at 200 mA typical

**Dimensions:**

1.75 W x 2.75 H x 2.38 in D (not including socket)

**Warranty:**

Lifetime

## Standard Features

**API 4058G Bridgesensor:**

- User-selectable input/output ranges and excitation voltages
- Convenient setup via rotary and slide switches
- Excitation voltage at 115 mA (10V) drives four 350-ohm load cells
- LED input/output signal indicators
- Selectable voltage or current outputs
- Functional test pushbutton

**441/442 Bridgesensor:**

- Input/output ranges and excitation voltage are selectable by easy-access rotary switches
- Non-interactive zero and span control
- Offset switch allows cancelling or “taring” of non-zero deadweights
- Excitation voltage of 115 mA (10V) drives up to four 350-ohm bridges
- Input/output LoopTracker™ LEDs show input/output status
- Functional test push-button with fixed level output to facilitate setup and troubleshooting
- Full isolation (input/output power) eliminates the effects of ground loops and noise

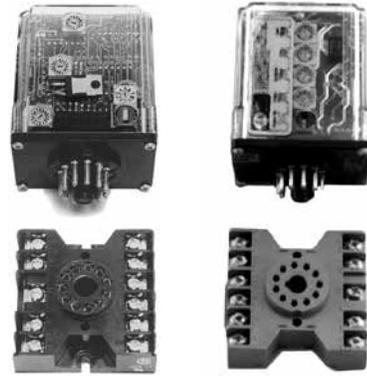

API 4058G Bridgesensor

441/442 Bridgesensor

## API 4058G Specifications

**Input/Output Ranges:**

See table on next page. Other switch-selectable ranges possible. See calibration instructions for more complete information, or consult factory.

**Input Impedance:**

1 Megohm minimum

**Output Capability:**

Voltage:  $\pm 10$ VDC;  $\pm 10$  mA  
 Current: 25 mA DC; 20V compliance

**Zero/Span Controls:**

Top-accessible, multi-turn  
 Range:  $\pm 15\%$  of span typical

**Excitation:**

10VDC maximum at 115 mA nominal; switch-selectable, 0-10VDC in 1 Volt increments; fine adjust;  $\pm 2.5\%$  via multi-turn

**Excitation Stability:**

$\pm 0.1\%$  per degree Celsius

**Response Time:**

70 mS standard

**Common Mode Rejection:**

Better than .02% of span per degree Celsius

**Operating Temperature Range:**

14°F to 140°F (-10°C to 60°C)

**Power:**

Standard: 115VAC,  $\pm 10\%$ , 50/60 Hz, 2.5W max  
 Optional: 230VAC,  $\pm 10\%$ , 50/60 Hz, 2.5W max  
 12VDC versions available; consult factory for availability

**Approvals:**

Model API 4058G: UL listed;  
 consult factory for numbers

**Weight:**

Approximately 2 lb (0.9 kg)

**Dimensions:**

1.75 W x 2.75 H x 2.38 in D (not including socket)

**Warranty:**

One-year limited warranty

# API 4058G - 441/442 Bridgesensors

Load Cell Signal Conditioners

## Part Number/Price

PART #	DESCRIPTION	EST. SHIP WEIGHT	PRICE
22778	API 4058G Bridgesensor	2lb	\$615.00
38902	441 Bridgesensor, 115VAC	2lb	715.00
38904	442 Bridgesensor, 9-30VDC	2lb	815.00

## 441/442 Input/Output Ranges

INPUT SPANS	VOLTAGE OUTPUTS	CURRENT
0-5 mV0 50 mV	0-1V	0-20 mA
0-10 mV0 100 mV	0-5V	4-20 mA
0-20 mV0 200 mV	1-5V	
0-25 mV0 250 mV	0-10V	
0-30 mV0 300 mV	±5V	
0-40 mV0 400 mV	±10V	

## API 4058G Input/Output Ranges

INPUT SPANS	OUTPUTS VOLTAGE	CURRENT
0-5 mV 0-100 mV	0-1V 0-8V	0-2 mA
0-10 mV 0-200 mV	0-2V 2-10V	0-10 mA
0-20 mV 0-250 mV	0-4V 0-10V	2-10 mA
0-25 mV 0-300 mV	0-5V	0-16 mA
0-30 mV 0-400 mV	1-5V	4-20 mA
0-40 mV 0-1000 mV	±5V	0-20 mA
0-50 mV 0-1200 mV	±10V	

# Amphenol® RJF 544

Harsh Environment Ethernet Connection System

## Specifications

**Data Transmission:**

10Base-T, 100Base-TX and 1000Base-T networks Category 5e per TIA/EIA 568B and ClassD per ISO/IEC 11801

**Mechanical:**

Quick push/pull coupling  
 RJ-45 cordset retention in the plug: 100N in the axis  
 Mating cycles: 500 min

**Environmental Protection:**

Sealing: IP67  
 Salt Spray > 1000h  
 Fire retardant/low smoke: UL94 V0 and NFF 16 16102, DIN 5510-2  
 Vibrations: 10-500 Hz, 10g, 3 axes:  
 no discontinuity > 10 nanos  
 Thermal Shock: 5 cycles at -40° C / +100° C

**Operating Temperature:**

-40°F to 185°F (-40°C to 85°C)

**Applications:**

Telecom equipment, video control, robotics, industrial process control, CNC machines, motion control, tele-maintenance

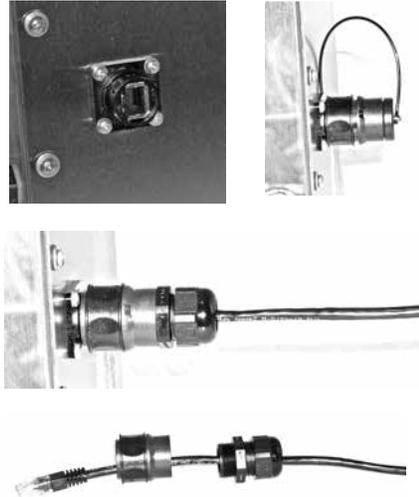

## Standard Features

- Allows an Ethernet Class D/Category 5e connection for 10Base-T, 100Base-TX, or 1000Base-T networks in harsh environments
- Sealed against fluids and dusts (IP67)
- Shock, vibration and traction resistant
- No cabling operation in the field
- No tools required
- Improved EMI protection
- Uses a standard RJ-45 cordset in protective composite plug to protect from shocks, dust and fluids
- In-field cabling and grounding not necessary

## Part Number/Price

PART #	DESCRIPTION	PRICE
87326	RJF 544 kit	\$155.00
87285	Square flange female connector	35.00
87286	Dust cap for harsh environment receptacles	35.00
87287	Gasket for harsh environment receptacles	5.00
87288	Ethernet plug	35.00
87289	Dust cap for harsh environment plugs	35.00

## Specifications

**Baud Rate:**  
9600

**Color:**  
Black

**Cable Length:**  
74 in (1880 mm)

**Bluetooth Cable Length:**  
16 in (406 mm)

**Power:**  
USB power, no external power supply

**Host:**  
PC and MAC compliant

**Connection:**  
DB9 male connector, Pin 2 RX, Pin 3 TX and Pin 5 Ground USBA connector

## Standard Features

- Converts serial data such as barcode reader or scale into keyboard input to software program
- Works with PC and MAC
- Requires no driver installation (identifies itself as additional HID keyboard)
- Cable draws power from USB port (no external power supply needed)
- Test cable to be connected with adapter scale cable or connector
- Bluetooth version allows Bluetooth connection to devices like iPad, Playbook, Android tablets and smart cell phones



## Part Number/Price

PART #	DESCRIPTION	WEIGHT	PRICE
119919	RS-232/USB Serial Cable	1 lb	\$185.00
132452	RS-232/USB Serial Cable plus Bluetooth	1 lb	260.00

## Options/Accessories

PART #	DESCRIPTION	PRICE
119064	Slimline Null Modem, gender changer DB9 female to female	\$10.50
22436	Blunt-end to DB9 female, straight cable	55.00
50749	DB9 female to DB9 female	55.00
130789	Null Model DB9 adapter female to male	12.00

## Specifications

**Baud Rate:**  
9600

**Data Bits:**  
8

**Parity:**  
None

**Power:**  
Requires 5VDC

**Customer Supplied:**  
Power and USB flash drive

**Industrial Enclosure Option:**  
7.5 x 7.5 x 4.5 in (19 x 19 x 12 cm)  
Latch for lock

**Warranty:**  
One-year limited warranty



**Text file examples (actual text will be dependent on transmitted file)**

02:50PM	
11/13/2012	
GROSS	58 lb
02:50PM	
11/13/2012	
GROSS	68 lb

## Standard Features

- LED on board for testing data transmission
- Captures data and stores it on a USB flash drive up to 8GB (not included)
- Transfer data to your PC using the USB flash drive

## Part Number/Price

PART #	DESCRIPTION	PRICE
153265	go-between board	\$410.00
153266	go-between industrial enclosure	500.00
153267	go-between desk enclosure	500.00
158778	go-between desk enclosure, EU power supply	500.00

## OPTIONS AND ACCESSORIES

PART #	DESCRIPTION	PRICE
154797	Adapter, power 5VDC 2A 90-264VAC, U.S. plug, UL/CUL	\$35.00
125077	USB flash drive, 1 GB	20.00



# In-Motion Weighing

Table of Contents

**MotoWeigh® In-Motion Conveyor Scale  
and Checkweigher..... 444**

**ESPAÑOL** | Visit [ricelake.com/spanish](http://ricelake.com/spanish)  
to see all RLWS materials  
available in Spanish

The following product names, logos, brands, and other trademarks featured  
or referred to within this publication are the property of their respective trademark holders.

# MotoWeigh® In-Motion Conveyor Scale and Checkweigher

## Standard Features

### Software

- Four levels of security
- Real time statistical information
- Product report
- Statistical report
- Parameter report
- User report
- Store up to 1,000 different products
- Five zone classification

### Control Panel

- Power disconnect with lock-out-tag-out
- E-stop
- VFD (variable frequency drive)
- Motor overloads

### Hardware

- Square tube construction (SST or Aluminum)
- 32 inch height from top of belt with +/- 2.5 inch of adjustment
- Modular belting
- Drive on right hand side of belt (looking down belt flow)
- Control panel mounted on left hand side of belt (looking down belt flow)



## Optional Features & Accessories

- Divert Methods
  - Pneumatic pusher
  - Air blast
  - Drop conveyor
  - Paddle
  - Secondary diverter in series or parallel
- Single, three or five zone stack-light
- Audible alarm (non-wash down only)
- Draft shields
- Drop chutes
- Pull cord E-stops
- Portability package (Non-NTEP only)
- Conveyor guide rails (round or flat)
- Custom programming available
- Food grade SST angle construction, NEMA 4X IP66 wash down systems
- Bar code scanner
- Labeling system
- UL 508
- Metal detection
- NTEP Legal for Trade (up to 2000 divisions and 60 ppm)
- Filling machine feedback
- Pacer belt in-feed

## Checkweigher Packages

*NTEP and Non-NTEP certified packages available in stainless steel and aluminum for food and non-food grade applications.*

### Checkweigher Packages Include

- Common framework for mounting conveyor scale on same frame as in-feed conveyor and indicator
- Basic control enclosure to interconnect wiring from photo eyes, divert solenoid and conveyor on/off/E-stop

## APPROVALS



On select models



Optional

## Specifications

### Construction:

Stainless steel food grade, stainless steel non-food grade or aluminum non-food grade

### Configurations:

Checkweigher or conveyor scale

### Speed:

Up to 240 ft per minute

### Container Types:

Boxes, bags, pouches, trays, tubs, cups, blister packs, display packs, clam shells

### Container Weights:

Up to 200 lb

Resolution down to 0.01 lb/5 grams, or better (dependent on scale capacity)

### Belts:

Interlox® Habasit®

### Power Configuration:

110 VAC single phase, 60 Hz

230/460 VAC 3 phase, 60 Hz

### Warranty:

Two-year limited warranty  
(excludes power train and wear parts)

### Approvals:

**NTEP:** Food grade stainless steel

Non-food grade aluminum

Non-food grade SST; 60 ppm at 2000 divisions

**Non-NTEP:** Food grade stainless steel

Non-food grade aluminum

**Non-NTEP:** Non-food grade SST; 80 ppm at 4000 divisions

**Optional:** UL 508

# MotoWeigh® In-Motion Conveyor Scale and Checkweigher

## Standard Sizes (Consult for custom sizes)

### WIDTH X LENGTH

12 in x 24 in	40 - 200 lb capacity conveyor scale
18 in x 36 in	40 - 200 lb capacity conveyor scale
18 in x 48 in	40 - 200 lb capacity conveyor scale
24 in x 36 in	40 - 200 lb capacity conveyor scale
24 in x 48 in	40 - 200 lb capacity conveyor scale
30 in x 60 in	40 - 200 lb capacity conveyor scale

The following must be defined when ordering:

- Units to be powered by either 115/230 or 460 VAC 3 phase
- Capacity
- Belt speed
- Select frame construction, aluminum or SST

Due to the variety of configurations, please consult the factory to discuss application requirements and for complete specifications and price quotations.

Questionnaire available at [www.ricelake.com/motoweigh](http://www.ricelake.com/motoweigh)

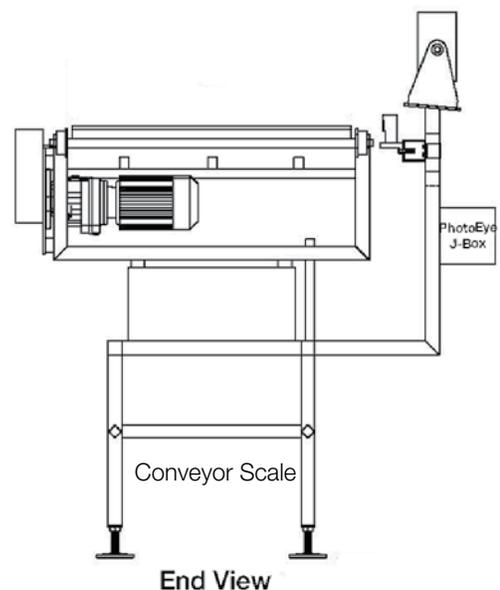
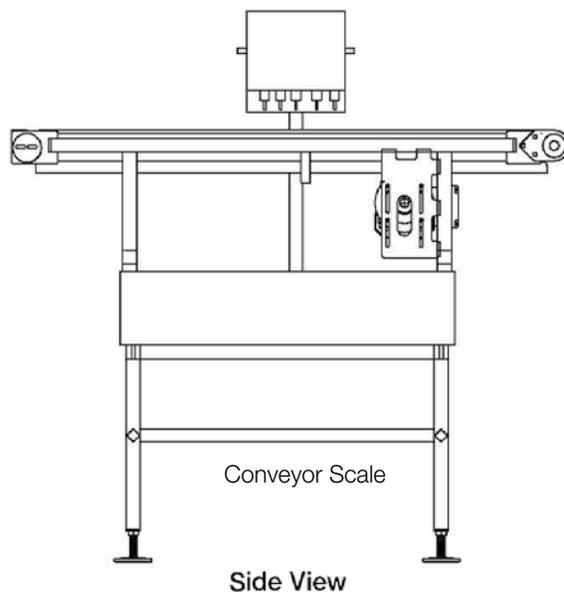
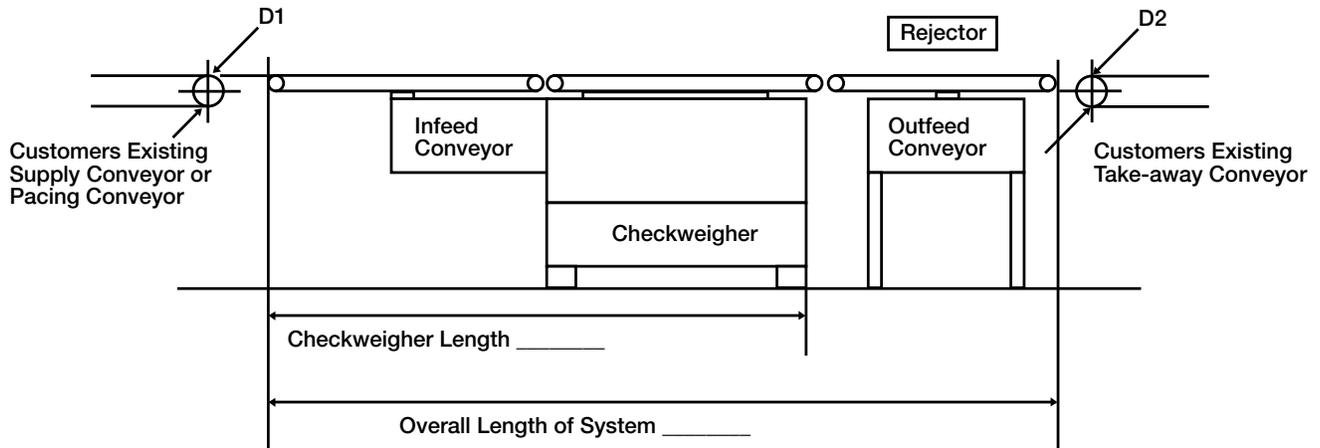



# Junction Boxes/Simulators

## Table of Contents

<b>JB4SS</b> .....	<b>448</b>
TuffSeal® Signal Trim Junction Box	
<b>JB4ES</b> .....	<b>449</b>
TuffSeal® Excitation Trim Junction Box	
<b>JB4SP and JB4SPT</b> .....	<b>450</b>
TuffSeal® Signal Trim Junction Box	
<b>JB4EP and JB4EPT</b> .....	<b>451</b>
TuffSeal® Excitation Trim Junction Box	
<b>EL204</b> .....	<b>452</b>
Signal Trim Junction Box	
<b>EL504</b> .....	<b>453</b>
Signal Trim Junction Box	
<b>JB8SP</b> .....	<b>454</b>
TuffSeal® Signal Trim Junction Box	
<b>JB8SPT</b> .....	<b>455</b>
TuffSeal® Signal Trim Junction Box	
<b>EL304A</b> .....	<b>456</b>
Signal Trim Junction Box	
<b>JB1010</b> .....	<b>457</b>
Signal/Excitation Trim Junction Box with Transient Protection	
<b>JB1010ST</b> .....	<b>458</b>
Signal Trim Junction Box with Transient Protection	
<b>Replacement Junction Boxes, Boards or Components</b> .....	<b>459</b>
<b>iQUBE 2®</b> .....	<b>460</b>
Digital Diagnostic Junction Box	
<b>EL168</b> .....	<b>462</b>
1-Cell Junction Box	
<b>TP75 DC</b> .....	<b>463</b>
Transient Protection	
<b>UJB3T6 DC</b> .....	<b>464</b>
Transient Protection	
<b>TP232 RS-232</b> .....	<b>465</b>
High Energy Serial Protection	
<b>Ranger 1</b> .....	<b>466</b>
<b>Ranger 3</b> .....	<b>466</b>
<b>Transducer Simulator 4</b> .....	<b>467</b>
<b>Ranger 5</b> .....	<b>467</b>
<b>Ranger 7</b> .....	<b>468</b>

**ESPAÑOL** | Visit [ricelake.com/spanish](http://ricelake.com/spanish)  
to see all RLWS materials  
available in Spanish

The following product names, logos, brands, and other trademarks featured or referred to within this publication are the property of their respective trademark holders.

# JB4SS

TuffSeal® Signal Trim Junction Box

## Standard Features:

- Stainless steel, NEMA 4X enclosure
- Jumpers to enable/disable a load cell
- PreVent™ breather vent
- Conformal coated circuit board
- Number of cells: 2 to 4 single cells
- Expansion port

## Applications:

- Floor, tank, hopper scales

## Specifications:

### Cable Fittings:

#### P/N 88956:

- (4) PG7 0.118-0.255 strain relief
- (2) PG11 0.197-0.394 strain relief
- (1) PreVent™ breather vent

#### P/N 107700:

- (4) PG9 0.138-0.315 strain relief
- (2) PG11 0.197-0.394 strain relief
- (1) PreVent™ breather vent

### Enclosure:

Stainless Steel NEMA 4X

### Connectors:

Spring clamp screwless, 12-28 AWG

### Trimming:

Individual cell, signal trim

### Potentiometers:

100k ohm, 25 turn cermet

### Circuit Board:

3.8 in x 2.3 in (96.5 mm x 58.4 mm), with conformal coating

### Warranty:

One-year limited warranty



## Part Number/Price

PART #	DESCRIPTION	PRICE
88956	JB4SS signal trim junction box with PG7 cord grips for load cells	\$235.00
107700	JB4SS signal trim junction box with PG9 cord grips for load cells	250.00
88958	Board only	150.00

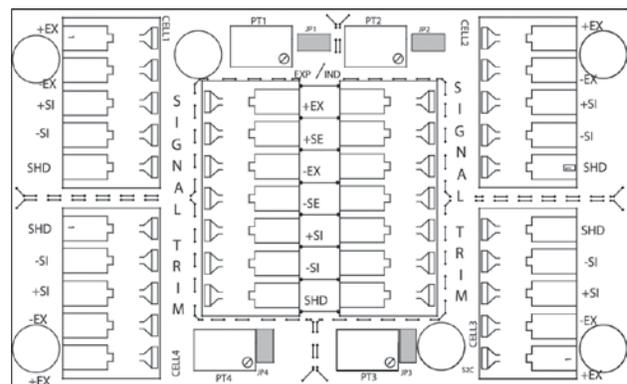
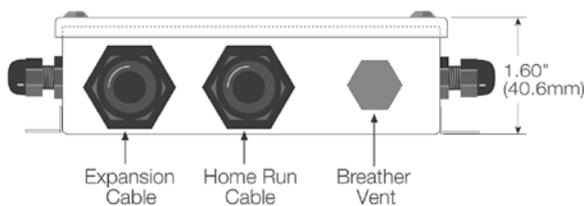
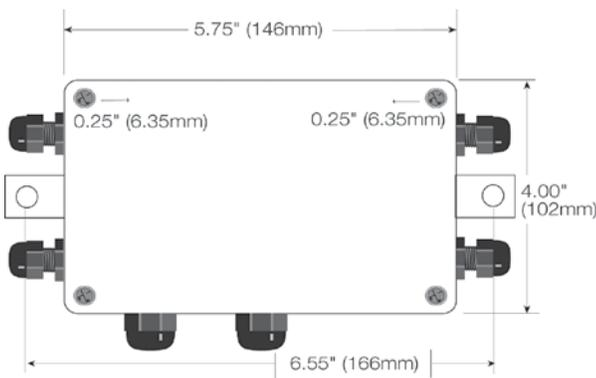

# JB4ES

TuffSeal® Excitation Trim Junction Box

## Standard Features:

- Stainless steel, NEMA 4X enclosure
- Jumpers to enable trimming
- PreVent™ breather vent
- Conformal coated circuit board
- Number of cells: 2 to 4 single cells
- Expansion port

## Applications:

- Floor, tank, hopper scales

## Specifications:

### Cable Fittings:

- (4) PG7 0.118-0.255 strain relief
- (2) PG11 0.197-0.394 strain relief
- (1) PreVent™ breather vent

### Enclosure:

Stainless Steel NEMA 4X

### Connectors:

Spring clamp screwless, 12-28 AWG

### Trimming:

Individual cell, excitation trim

### Potentiometers:

100 ohm, 25 turn cermet

### Circuit Board:

3.8 in x 2.3 in (96.5 mm x 58.4 mm), with conformal coating

### Warranty:

One-year limited warranty



## Part Number/Price

PART #	DESCRIPTION	PRICE
91779	JB4ES excitation trim junction box	\$235.00
89446	Board only	150.00

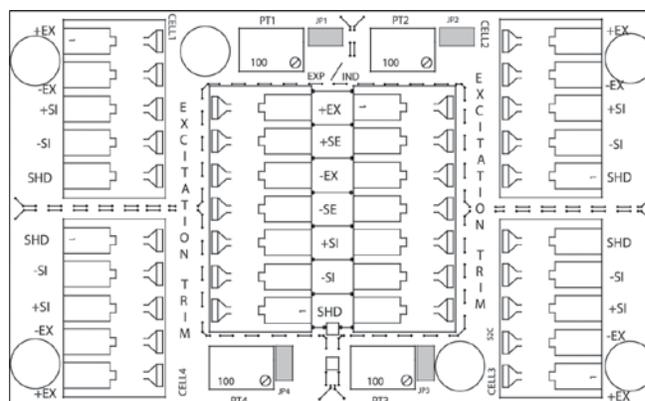
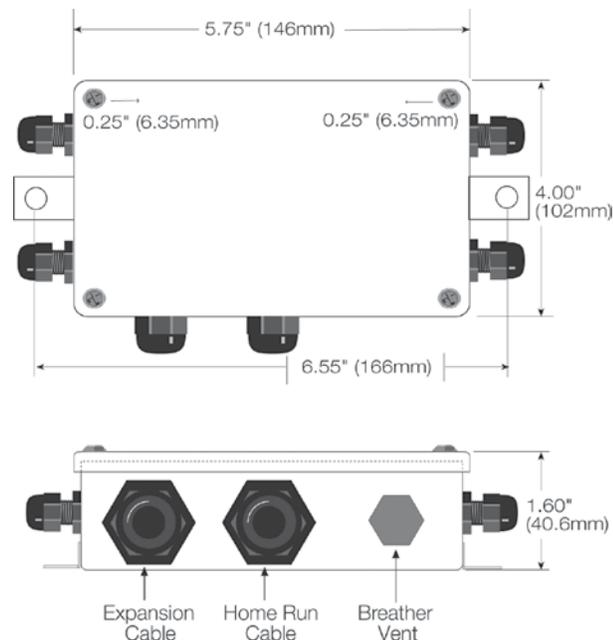

# JB4SP and JB4SPT

TuffSeal® Signal Trim Junction Box

## Standard Features:

- Fiberglass Reinforced Polyester (FRP) (NEMA 4X) enclosure with stainless steel cover screws
- Jumpers to enable/disable a load cell
- PreVent™ breather vent
- Conformal coated circuit board
- Number of cells: 2 to 4 single cells
- Expansion port

## Applications:

- Tank and hopper scales

## Specifications:

### Cable Fittings:

- (4) PG7 0.118-0.255 strain relief
- (2) PG11 0.197-0.394 strain relief
- (1) PreVent™ breather vent

### Enclosure:

Molded FRP (NEMA 4X) enclosure with overlapping solid cover, stainless steel screws

### Connectors:

Spring clamp screwless, 12-28 AWG

### Trimming:

Individual cell, signal trim

### Potentiometers:

100 k ohm, 25 turn cermet

### Circuit Board:

3.8 in x 2.3 in (96.5 mm x 58.4 mm), with conformal coating

### Warranty:

One-year limited warranty



## Part Number/Price

PART #	DESCRIPTION	PRICE
91780	JB4SP signal trim 4-channel with expansion	\$255.00
92762	JB4SPT signal trim with transient protection	445.00
88958	Board only	150.00
89894	Transient board	215.00

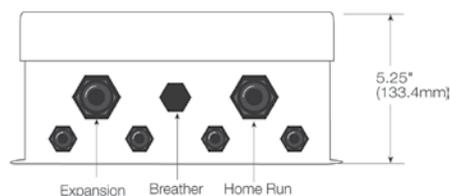

JB4SP

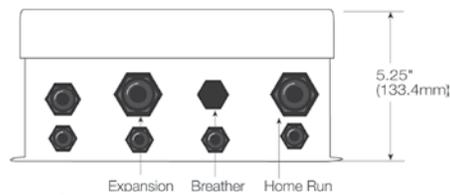

JB4SPT

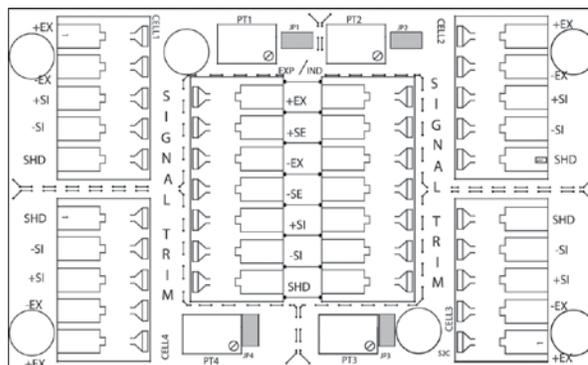
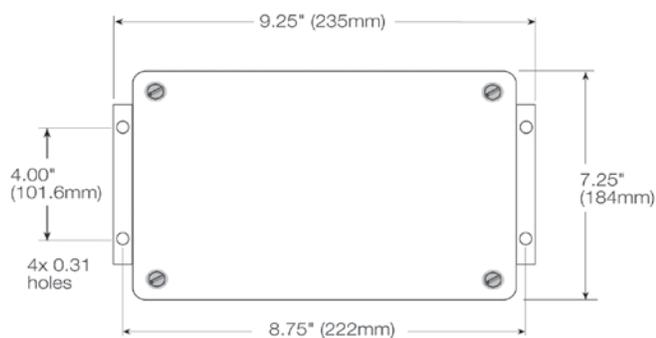



# JB4EP and JB4EPT

TuffSeal® Excitation Trim Junction Box

## Standard Features:

- Fiberglass Reinforced Polyester (FRP) (NEMA 4X) enclosure with stainless steel cover screws
- Jumpers to enable trimming
- PreVent™ breather vent
- Conformal coated circuit board
- Number of cells: 2 to 4 single cells
- Expansion port

## Applications:

- Tank and hopper scales

## Specifications:

### Cable Fittings:

- (4) PG7 0.118-0.255 strain relief
- (2) PG11 0.197-0.394 strain relief
- (1) PreVent™ breather vent

### Enclosure:

Molded FRP (NEMA 4X) enclosure with overlapping solid cover, stainless steel screws

### Connectors:

Spring clamp screwless, 12-28 AWG

### Trimming:

Individual cell, excitation trim

### Potentiometers:

100 ohm, 25 turn cermet

### Circuit Board:

3.8 in x 2.3 in (96.5 mm x 58.4 mm), with conformal coating

### Warranty:

One-year limited warranty

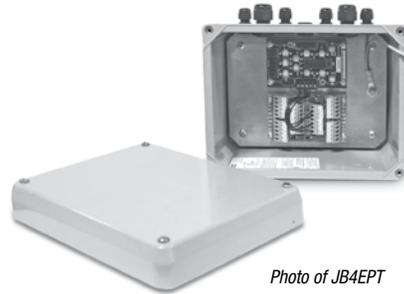
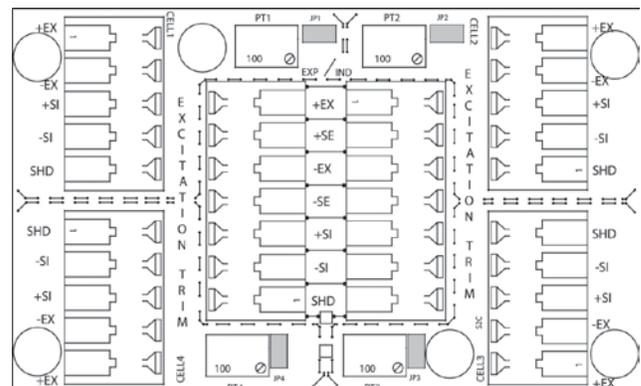
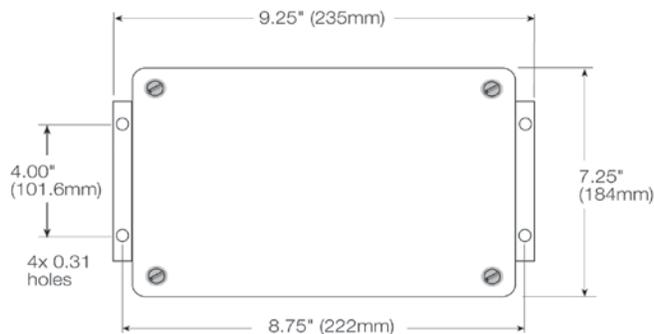
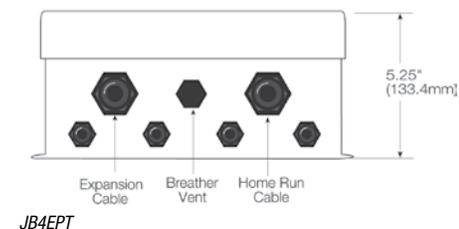
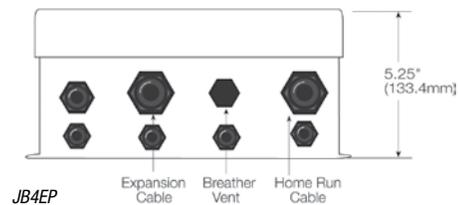

Photo of JB4EPT



## Part Number/Price

PART #	DESCRIPTION	PRICE
91781	JB4EP excitation trim junction box	\$255.00
92763	JB4EPT excitation trim junction box with transient protection	445.00
89446	Board only	150.00
89894	Transient board	215.00



# EL204

## Signal Trim Junction Box

### Standard Features:

- ABS enclosure with molded-in cable fittings
- Premium screw terminals
- 6-screw attachment to lid, die cut gasket for superior environment protection
- Number of cells: 2 to 4 single cells

### Applications:

- Floor, hopper, tank or livestock applications

### Specifications:

#### Cable Fittings:

Five water tight nylon compression fittings, 0.210-0.280 in (5.3 x 7.1 mm)

#### Connectors:

Spring clamp screwless, 12-28 AWG

#### Trimming:

Individual cell trim, signal trim

#### Potentiometers:

100K ohm, 25 turn cermet

#### Enclosure:

ABS with molded through-fittings, sealed 6-screw lid

#### Circuit Board:

3.8 x 2.3 in (96.5 x 58.4 mm); with conformal coating

#### Warranty:

One-year limited warranty

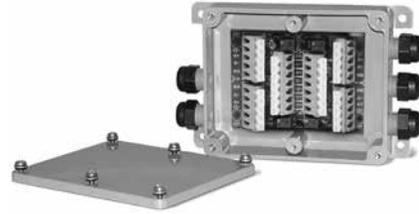

### Part Number/Price

PART #	DESCRIPTION	PRICE
73428	EL204 junction box	\$185.00
88958	Board Only	150.00

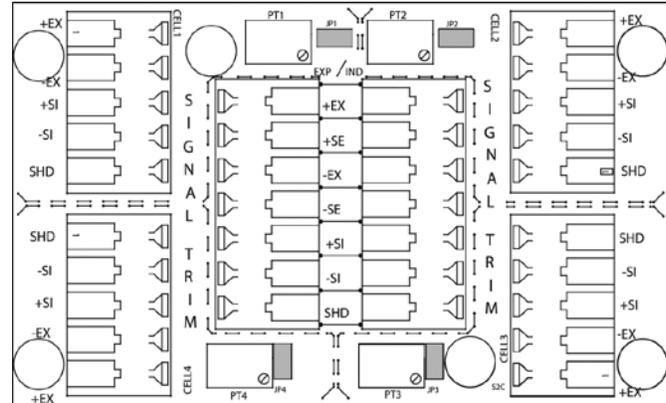
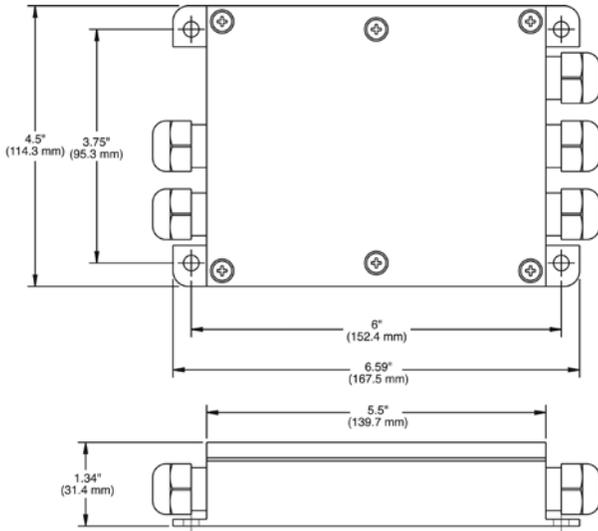

# EL504

## Signal Trim Junction Box

### Standard Features:

- Stainless steel, NEMA 4X enclosure
- Strain relief cable fittings
- Removable connectors for easy wiring
- Number of cells: 2 to 4 single cells (even number of cells only)
- Any unused channels require modification

### Applications:

- Truck scales
- Floor scales
- Limited space installations

### Specifications:

#### Cable Fittings:

(5) nylon 0.187-0.312 in (4.7-7.9 mm) cable strain reliefs

#### Connectors:

Electrovert 0.197 in (5.0 mm) miniature two piece connectors. Maximum wire size #14 AWG, connectors are removable for easy wiring.

#### Trimming:

Individual cell trim, signal trim

#### Potentiometers:

100 k ohms, 25-turn cermet

#### Enclosure:

Stainless steel NEMA 4X, 40 PSI washdown

#### Circuit Board:

6.5 x 1.5 in (165.1 x 38.1 mm) with anti-fungal coating

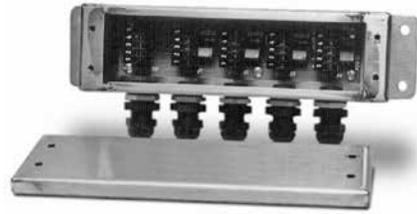

### Part Number/Price

PART #	DESCRIPTION	PRICE
21165	EL504 signal trim junction box	\$325.00
21296	Board only	255.00

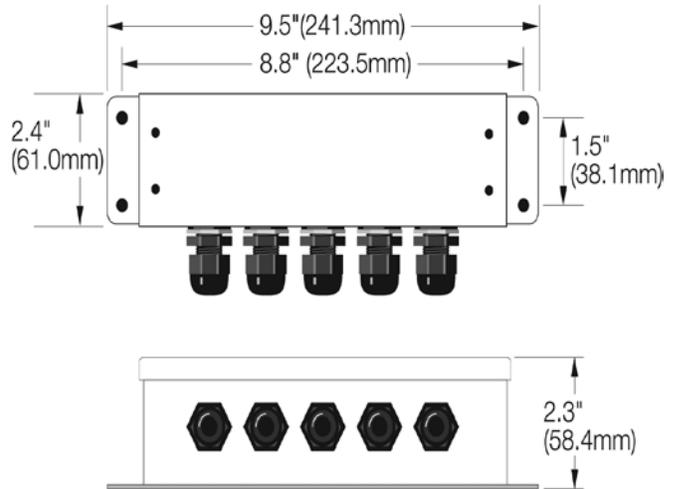

# JB8SP

TuffSeal® Signal Trim Junction Box

## Standard Features:

- Fiberglass Reinforced Polyester (FRP) (NEMA 4X) enclosure
- PreVent™ breather vent
- Conformal coated circuit board
- Removable load cell connectors
- Section and individual cell trim capability
- Number of cells: 2, 4, 6 or 8 single load cells (even number only)
- Expansion port

## Applications:

- Truck, livestock and railroad scales

## Specifications:

### Cable Fittings:

- (9) 3/8 in NPT 0.157 in-0.314 in
- (2) 1/2 in NPT 0.272 in-0.472 in
- (1) PreVent™ breather unit

### Enclosure:

Molded FRP (NEMA 4X) enclosure with overlapping solid cover, stainless steel screws

### Connectors:

Pluggable screw type, 12-28 AWG

### Trimming:

Individual cell trim, range

### Potentiometers:

100 k ohm, 25 turn cermet

### Circuit Board:

5.7 in x 7.2 in with conformal coating

### Warranty:

One-year warranty



## Part Number/Price

PART #	DESCRIPTION	PRICE
91782	JB8SP signal trim 8-channel with expansion	\$425.00
*89889	Board only	365.00

\* For Rev. B and new boards

## Options/Accessories

PART #	DESCRIPTION	PRICE
92734	Coupling, 1/2 in NPT cord grip to 3/4 in NPT conduit fitting	\$25.00
92735	Coupling, 3/8 in NPT cord grip to 3/4 in NPT conduit fitting	25.00

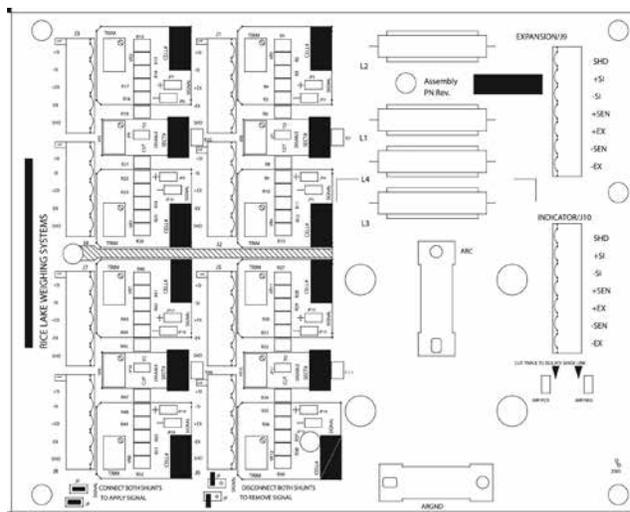
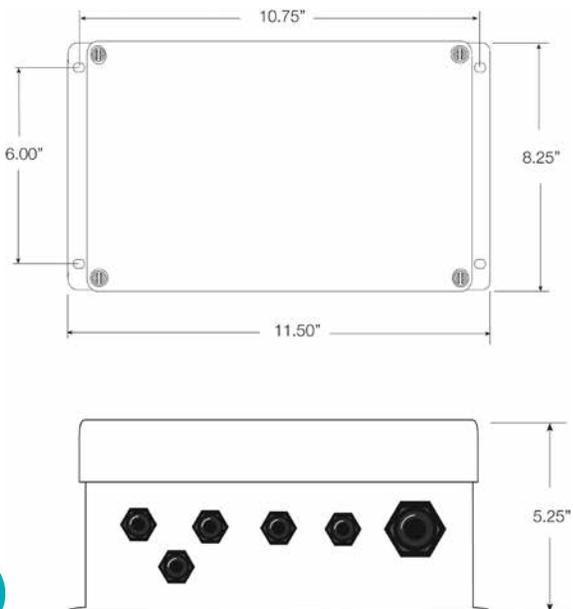

# JB8SPT

TuffSeal® Signal Trim Junction Box

## Standard Features:

- Fiberglass Reinforced Polyester (FRP) (NEMA 4X) enclosure
- PreVent™ breather vent
- Conformal coated circuit board
- Removable load cell connectors
- Section and individual cell trim capability
- Field replaceable transient protection
- (1) coupling, 1/2 NPT cord grip to 3/4 in NPT conduit fitting for homerun cable
- Number of cells: 2,4,6 or 8 single load cells (even number only)
- Expansion board

## Applications:

- Truck, livestock and railroad scales

## Specifications:

### Cable Fittings:

- (9) 3/8 in NPT 0.157 in-0.314 in
- (2) 1/2 in NPT 0.272 in-0.472 in
- (1) PreVent™ breather unit

### Enclosure:

Molded FRP (NEMA 4X) enclosure with overlapping solid cover, stainless steel screws

### Connectors:

Pluggable screw type, 12-28 AWG

### Trimming:

Individual cell trim

### Potentiometers:

100 k ohm, 25 turn cermet

### Circuit Board:

5.7 in x 7.2 in with conformal coating

### Warranty:

One-year warranty



## Part Number/Price

PART #	DESCRIPTION	PRICE
91783	JB8SPT signal trim junction box with transient protection	\$625.00
*89889	Board only	365.00
89894	Transient board	215.00
91785	Enclosure only	230.00

\* For Rev. B and newer boards

## Options/Accessories

PART #	DESCRIPTION	PRICE
92734	Coupling, 1/2 in NPT cord grip to 3/4 in NPT conduit fitting	\$25.00
92735	Coupling, 3/8 in NPT cord grip to 3/4 in NPT conduit fitting	25.00

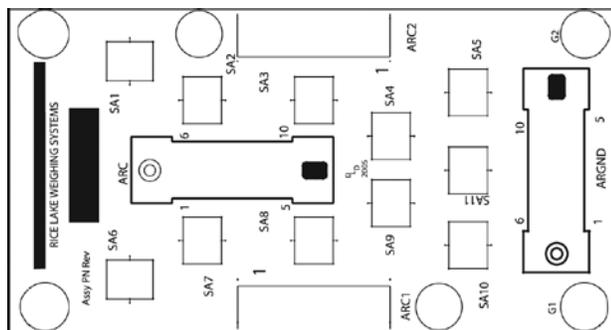
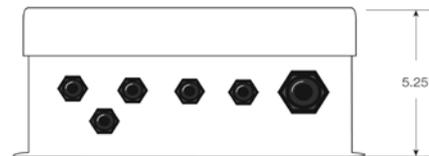

Transient Board

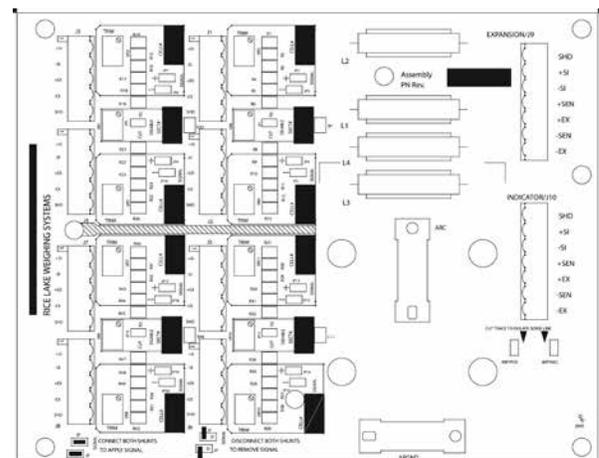

Load Cell Board

# EL304A

## Signal Trim Junction Box

### Standard Features:

- NEMA 4X Fiberglass-Reinforced Polyester (FRP) enclosure
- Strain relief cable fittings
- Individual cell signal disconnect switches
- Number of cells: 2 to 4 single cells (even number of cells only)
- Expansion port

### Applications:

- Livestock scales
- Tank and vessel weighing
- Corner and/or section trim applications

### Specifications:

#### Cable Fittings:

- 4 nylon cable strain reliefs 0.079-0.236 in (2.0-6.0 mm)
- 2 nylon cable strain reliefs 0.236-0.354 in (6.0-9.0 mm)

#### Connectors:

Electrovert 0.197 in (5.0 mm) miniature screw terminals. Maximum wire size # 14 AWG

#### Trimming:

Individual cell and section, signal trim

#### Potentiometers:

100k ohms, 25-turn cermet

#### Enclosure:

FRP NEMA 4X, 40 PSI washdown

#### Circuit Board:

5.5 x 4 in (139.7 x 101.6 mm) with anti-fungal coating

#### Warranty:

One-year limited warranty

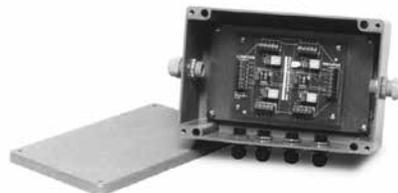

### Part Number/Price

PART #	DESCRIPTION	PRICE
21169	EL304A signal trim 4-channel junction box	\$295.00
21301	Board only	215.00

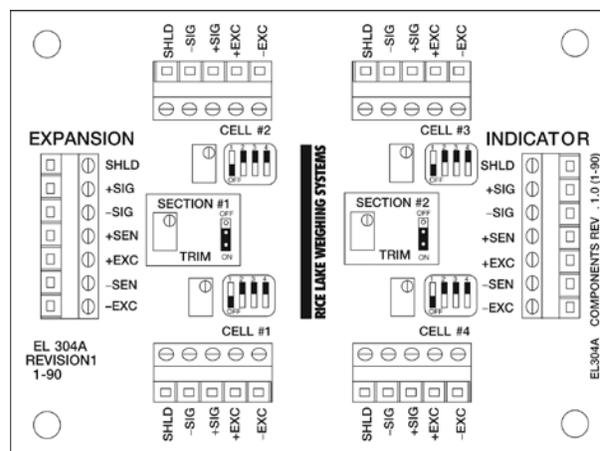
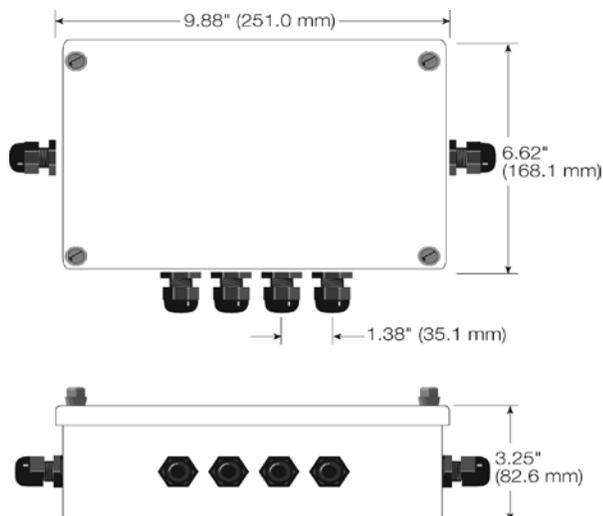

# JB1010

Signal/Excitation Trim Junction Box with Transient Protection

## Standard Features:

- NEMA 4X Fiberglass-Reinforced Polyester (FRP) enclosure
- Transient protection
- Signal or excitation trim
- Front panel mounting
- Strain relief cable fittings
- Number of cells: 1 through 10 with expansion
- Trims odd numbers of cells without modification

## Applications:

- Tank, truck, railroad, hopper and floor scales
- Universal field replacement of existing boxes
- Expansion of existing scales

## Specifications:

### Mounting Centers:

3.75 x 2.31 in (95.2 x 58.7 mm)

### Cable Fittings:

Nylon waterproof strain-relief type

### Cable Diameter:

0.079-0.314 in (2.0-8.0 mm)

### Trimming:

Individual cell and section signal and excitation trimming

### Terminal Block:

Rated 300V/15A; 7-position screw terminal can each accommodate up to #16 AWG

### Warranty:

One-year limited warranty



## Part Number/Price

PART #	DESCRIPTION	PRICE
36231	JB1010 signal/excitation trim junction box	\$650.00
36351	Board only	455.00

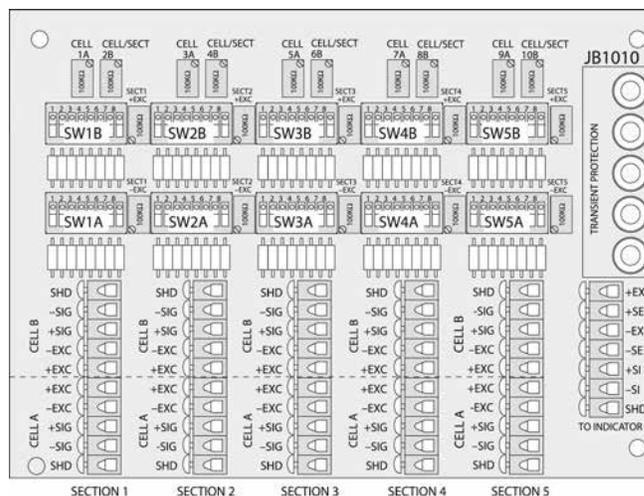
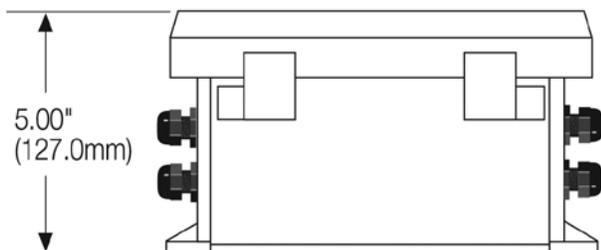
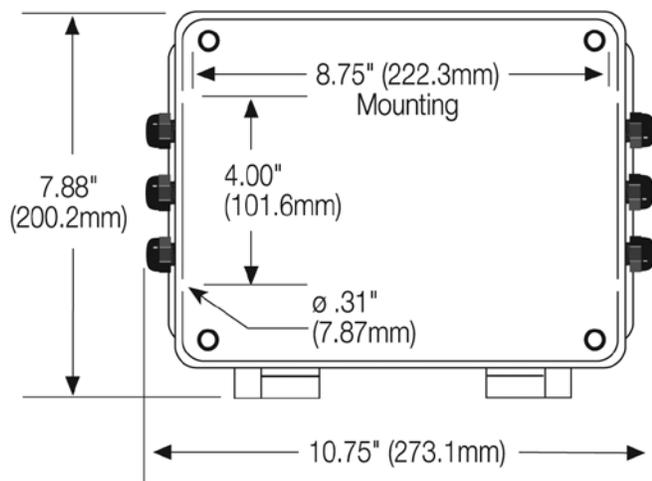

# JB1010ST

Signal Trim Junction Box with Transient Protection

## Standard Features:

- NEMA 4X stainless steel enclosure
- Transient protection using gas discharge tubes
- Section and individual cell trim capability
- Compact enclosure only 1.75 in deep
- Strain relief cable fitting
- Number of cells: 2, 4, 6, 8 or 10 single load cells
- Any unused channels require modification

## Applications:

- Tank, truck and railroad scales
- Summing 10 load cells with individual and section trimming capability

## Specifications:

### Cable Fittings:

11 nylon cable strain relief for cable dimension range: 0.079 to 0.314

### Connectors:

Electrovert 0.197 miniature screw terminals, 5-positions  
 Maximum wire size: # 14 AWG  
 External enclosure ground stud

### Trimming:

Individual cell and section signal trim

### Potentiometers:

100 k Ω, 25 turns cerment

### Enclosure:

Stainless steel

### Circuit Board:

6.5 x 4.5 in (165.1 x 114.3 mm)

### Warranty:

One-year limited warranty

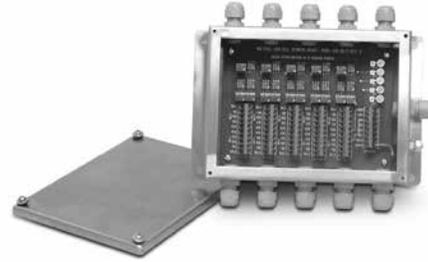

## Part Number/Price

PART #	DESCRIPTION	PRICE
68813	JB 1010ST signal trim junction box	\$575.00
68811	Board only	435.00

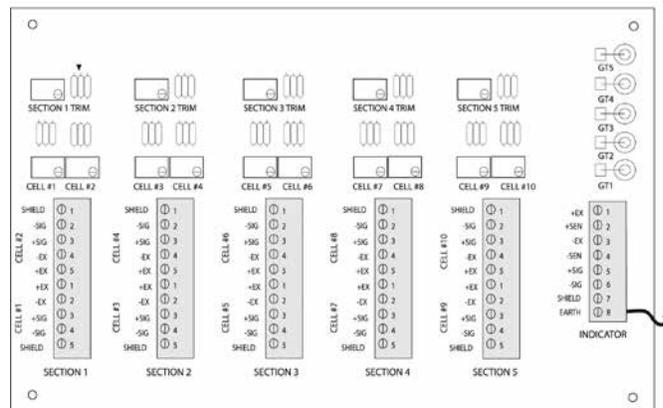
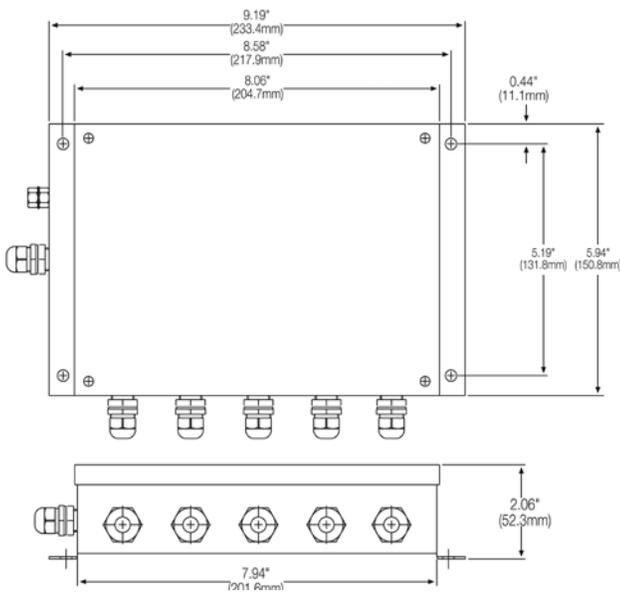



# Replacement Junction Boxes, Boards or Components

MODEL	COMPLETE J-BOX REPLACEMENT	REPLACEMENT BOARD ONLY	REPLACEMENT CORD GRIPS	Replacement Pressure & Condensation Vent	DESICCANT PACKS
JB4SS	88956 \$235.00	88958 \$150.00	58983=PG7, \$4.00 59001=PG11 \$3.70	88733 PreVent™ breather (vent) \$22.00 88734 (vent nut) \$1.05	92240 \$1.10
JB4ES	91779 \$235.00	89446 \$150.00	58983=PG7, \$4.00 59001=PG11 \$3.70	88733 PreVent™ breather (vent) \$22.00 88734 (vent nut) \$1.05	92240 \$1.10
JB4SP JB4SPT	91780 \$255.00 92762 \$445.00	88958 (load cell) \$150.00 & 89894 (transient protection) \$215.00	58983=PG7, \$4.00 59001=PG11 \$3.70	88733 PreVent™ breather (vent) \$22.00 88734 (vent nut) \$1.05	16039 \$2.00
JB4EP JB4EPT	91781 \$255.00 92763 \$445.00	89446 (load cell) \$150.00 & 89894 (transient protection) \$215.00	58983=PG7, \$4.00 59001=PG11 \$3.70	88733 PreVent™ breather (vent) \$22.00 88734 (vent nut) \$1.05	16039 \$2.00
EL204	73428 \$185.00	88958 \$150.00	N/A	N/A	N/A
JB8SP	91782 \$425.00	**89889 \$365.00	15655 (cord grip) \$2.10 & 15656 (nut) \$1.05 =3/8" NPT 15628 (cord grip) \$4.00 & 15630 (nut) \$3.00 =1/2" NPT	88733 PreVent™ breather (vent) \$22.00 88734 (vent nut) \$1.05	16039 \$2.00
JB8SPT	91783 \$625.00	89889 (load cell) \$365.00 & 89894 (transient protection) \$215.00	15655 (cord grip) \$2.10 & 15656 (nut) \$1.05 =3/8" NPT 15628 (cord grip) \$4.00 & 15630 (nut) \$3.00 =1/2" NPT	88733 PreVent™ breather (vent) \$22.00 88734 (vent nut) \$1.05	16039 \$2.00
EL304A	21169 \$295.00	21301 \$215.00	N/A	N/A	N/A
JB1010	36231 \$650.00	36351 \$455.00	N/A	N/A	N/A
JB1010ST	68813 \$575.00	68811 \$435.00	N/A	N/A	N/A
EL210	91781, JB4EP* \$255.00	92472 \$155.00	58983=PG7, \$4.00 59001=PG11 \$3.70	N/A	N/A
EL211A	91780, JB4SP (However the board does not have section trim capabilities)* \$255.00	92473, \$160.00 (However the board does not have section trim capabilities)	58983=PG7, \$4.00 59001=PG11 \$3.70	N/A	N/A
EL604-AL	88956, JB4SS* \$235.00	88958 \$150.00	58983=PG7, \$4.00 59001=PG11 \$3.70	N/A	N/A
EL604STA	88956, JB4SS* \$235.00	88958 \$150.00	58983=PG7, \$4.00 59001=PG11 \$3.70	N/A	N/A
EL604ETA	91779, JB4ES* \$235.00	89446 \$150.00	58983=PG7, \$4.00 59001=PG11 \$3.70	N/A	N/A
EL504	21165 \$325.00	21296 \$255.00	N/A	N/A	N/A
JB808S	91782, JB8SP* \$425.00	92471 \$385.00	15655 (cord grip) \$2.10 & 15656 (nut) \$1.05 =3/8" NPT 15628 (cord grip) \$4.00 & 15630 (nut) \$3.00 =1/2" NPT	N/A	N/A
JB818ST	91783, JB8SPT* \$625.00	Need (1) 77445 \$55.00 (1) 89889 \$365.00, & (1) 89894 \$215.00	15655 (cord grip) \$2.10 & 15656 (nut) \$1.05 =3/8" NPT 15628 (cord grip) \$4.00 & 15630 (nut) \$3.00 =1/2" NPT	N/A	N/A

\*See catalog pages for enclosure dimensions \*\*Can only be used with Rev. B and newer board

# iQUBE 2®

## Digital Diagnostic Junction Box

### Standard Features:

- iQUBE board has four A/D channels
- NEMA 4X polyester or stainless steel enclosure
- Supports networking up to four boards, for 16 A/D channels. Connection can be up to four separate platforms with a system total, or four separate scales systems
- Diagnostic routines for weighing errors and system health
- Cell tests for overloaded, underloaded, zero reference, drift, noise, and unbalanced conditions
- Onboard status LED's for communications and visual bi-color indication of cell health
- Cell Emulator compensates for load cell failure until a repair can be made
- Cal-Match® algorithm automatically trims and calibrates the scale in one pass of test weights (stopping over each mount)
- Standard communication RS-232/RS-422 Option card slot for Fiber Optic, Ethernet TCP/IP or Wireless TCP/IP
- Four digital I/O per card, for push button operation, set point control, or cell status

### Applications:

- Mission critical weighing processes, including:
- Truck and railroad track scales
- Tank and hopper scales
- Multi-channel scales

### Specifications:

**Enclosure:**

NEMA 4X FRP or stainless steel

**Voltage Input:**

115/230V AC power supply DC/DC converter for 9-36V  
6-12V DC to CPU

**Load Cell Inputs:**

4 channels per board up to 4 networked boards

**A/D Sampling Rate:**

2.5-500 Hz (selectable)

**Temperature Range:**

14°F to 104°F (-10°C to 40°C)

**Analog signal sensitivity:**

0.3 uV/grad at 30 Hz  
0.5 uV/grad at 100 Hz  
1.2 uV/grad at 500 Hz

**Load Cell Excitation:**

5V DC, 57 mA maximum per channel

**Analog range:**

-4.5 mV/V to +4.5 mV/V

**Approvals:**

NTEP 03-032A1  
Measurement Canada - AM-5561, Rev. 1  
UL E151461  
CE

**Warranty:**

Two-year limited warranty

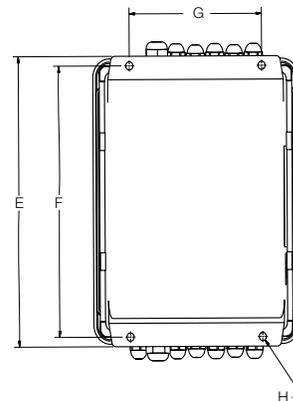
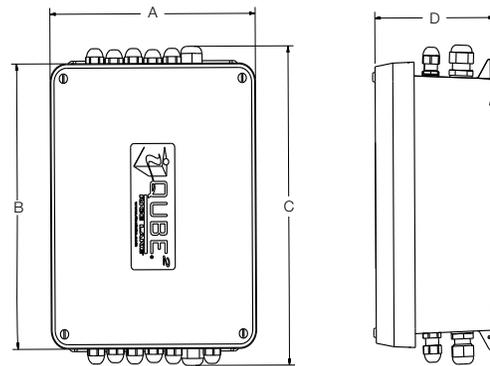

DIMENSIONS			
<b>Stainless Steel 8 in x 10 in</b>			
A	8.91 in (226.3 mm)	E	11.50 in (292.1 mm)
B	10.13 in (257.3 mm)	F	10.75 in (268.5 mm)
C	12.57 in (319.3 mm)	G	6.00 in (152.4 mm)
D	4.29 in (109 mm)	H	0.312 in (7.9 mm)
<b>FRP Large 10 in x 12 in</b>			
A	11.30 in (287 mm)	E	13.53 in (343.7 mm)
B	13.33 in (338.6 mm)	F	12.76 in (324.1 mm)
C	14.00 in (355.6 mm)	G	8.00 in (203.2 mm)
D	5.57 in (141.5 mm)	H	0.312 in (7.9 mm)
<b>FRP Small 8 in x 10 in</b>			
A	9.31 in (236.5 mm)	E	11.51 in (287.2 mm)
B	11.31 in (287.2 mm)	F	10.75 in (273.1 mm)
C	12.85 in (326.4 mm)	G	6.00 in (152.4 mm)
D	5.42 in (137.7 mm)	H	0.312 in (7.9 mm)

## Part Number/Price

PART #	DESCRIPTION	EST. SHIP WEIGHT	PRICE
<b>With AC Power Supply</b>			
108425*	iQUBE2, 4-channel, FRP 8 in x 10 in junction box	9 lb	\$1,025.00
108426	iQUBE2, 4-channel, FRP 10 in x 12 in junction box	11 lb	1,175.00
108427	iQUBE2, 8-channel, FRP 10 in x 12 in junction box	11 lb	1,900.00
108428*	iQUBE2, 4-channel, stainless steel 8 in x 10 in junction box	13 lb	1,425.00
<b>Without Power Supply</b>			
108429*	iQUBE2, 4-channel, FRP 8 in x 10 in junction box	8 lb	925.00
108430	iQUBE2, 4-channel, FRP 10 in x 12 in junction box	10 lb	1,075.00
108431	iQUBE2, 8-channel, FRP 10 in x 12 in junction box	10 lb	1,800.00
108432*	iQUBE2, 4-channel, stainless steel 8 in x 10 in junction box	12 lb	1,325.00
<b>Conduit Adapters</b>			
92734	Conduit adapter 3/8 NPT to 3/4 NPT		25.00
92735	Conduit adapter 1/2 NPT to 3/4 NPT		25.00

Enclosure size 8 x 10 in required for truck scale j-box pocket

## Options/Accessories

PART #	DESCRIPTION	PRICE
108433	Four channel iQUBE2 board with cables and connectors	\$725.00
97475	DC/DC power supply, 9-36V DC (requires factory installation)	155.00
108434	Remote power supply 115/230V AC and transient board with enclosure	250.00
109396	Transient board	65.00
110949	Transient board with mount	80.00
112979	Digi XTend radio, 900 MHz, high data throughput	895.00
161936	Hotspot WiFi 802.11 a, b, g	1,195.00
161954	Hotspot in FRP enclosure	2,245.00
<b>Communication Card</b>		
108579	RS-232/RS-485 port	260.00
77142	Ethernet TCP/IP	400.00
108671	Wireless LAN 802.11 B/G	570.00
93245	USB port	160.00
77143	Fiber Optic board	200.00
77788	Fiber Optic board (installed in 920i)	200.00
<b>Duplex Fiber (Max Run 350 ft)</b>		
78026	Fiber Optic cable, 100 ft	135.00
78027	Fiber Optic cable, 200 ft	270.00
78910	Fiber Optic cable, custom length	1.35/ft
<b>Home Run Cable</b>		
116587	EL 166 16 gauge, 6 conductor, shielded	2.65/ft
<b>Software</b>		
77925	Revolution® Configuration Software	35.00
108435	Virtui2® Virtual Indicator Demo CD	n/c
108436	Virtui2 Activation part number	500.00
112262	Firmware update flash cable	50.00
<b>920i Indicators for use with iQUBE2, requires version 4 software</b>		
77790	920i Universal, 115V AC, without A/D	1,750.00
77791	920i Universal, 230V AC, without A/D	1,750.00
93243	920i Deep Universal, 115V AC, without A/D	1,950.00
93244	920i Deep Universal, 230V AC, without A/D	1,950.00
77792	920i Panel Mount, 115V AC, without A/D	1,750.00
77793	920i Panel Mount, 230V AC, without A/D	1,750.00
77794	920i Wall Mount, 115V AC, without A/D	2,350.00
77795	920i Wall Mount, 230V AC, without A/D	2,350.00

## Sample Configurations\*

\*Not an actual system—illustrates connectivity



# EL168

1-Cell Junction Box

## Standard Features:

- Non-metallic PVCX enclosure with separate input and output cable fittings
- No soldering, compression or swagged fittings are required

## Applications:

- For splicing or extending load cell cable

## Specifications:

**Dimensions:**

4 W x 4 L x 2.5 in D

**Mounting Centers:**

3.75 in x 2.31 in (95.2 mm x 58.7 mm)

**Cable Fittings:**

Nylon waterproof strain-relief type

**Cable Diameter:**

0.079 in-0.314 in (2.0 mm-8.0 mm)

**Terminal Block:**

Rated 300V/15A; 7-position, screw terminal can each accommodate up to # 16 AWG

**Warranty:**

One-year limited warranty



## Part Number/Price

PART #	DESCRIPTION	PRICE
21161	EL168 1-cell junction box	\$66.00

# TP75 DC

Transient Protection

## Standard Features:

- Avalanche diode design
- Full 6-wire with shield protection
- NEMA 4X enclosure
- Unlimited number of parallel load cells; up to 8 in series
- Terminal lugs provided

## Applications:

- Protects load cells and indicators from voltage transients
- Tank, bin and hopper
- Truck and railroad track scales
- Suitable for outdoor use

## Specifications:

### Protection Type:

6-channel series type with separate shield

### Maximum Excitation Voltage:

22.8V DC

### Response Time:

5 nanoseconds

### Peak Surge Currents:

100 amps

### Series Resistance:

0.0 ohms

### Series Inductance:

0.0  $\mu$ h

### Grounding:

10 AWG wire or larger (not provided)

### Cable Fitting:

(2) nylon strain relief for 0.187 in-0.312 in (4.7 mm-7.9 mm) diameter cable

### Enclosure:

Impact-resistant polycarbonate NEMA 4X, maximum 40 psi washdown

### Operating Temperature:

4°F to 121°F (-20°C to 85°C)

### Circuit Board Dimensions:

2.22 in x 2.22 in (56.4 mm x 56.4 mm)

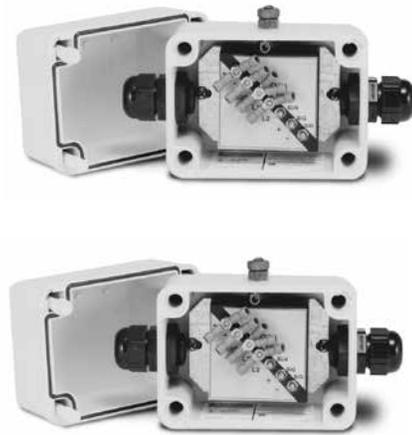

## Part Number/Price

PART #	DESCRIPTION	PRICE
33185	TP75 DC transient protection	\$225.00

## Options/Accessories

PART #	DESCRIPTION	PRICE
31164	Circuit board only	\$170.00

# UJB3T6 DC

Transient Protection

## Standard Features:

- Factory serviceable
- Full 6-wire with shield protection
- #6 SEMS screw type; accepts spade lugs, tinned leads or bare wires up to #12 AWG
- Up to 8 parallel or summed load cells
- 50 k baud maximum transmission frequency
- Up to 6 serial data lines can be protected instead of load cells

## Applications:

- Protects load cells from voltage transients
- Compatible with signals down to 1µVgrad
- Installations exposed to significant transients
- Protects serial communication lines

## Specifications:

**Protection Type:**

6-channel series type with separate shield

**Maximum Excitation Voltage:**

20V DC or 20V AC

**Clamping Voltage:**

75V DC or 75V AC

**Clamping Time:**

75V DC Stages <100 nanoseconds typical

**Peak Surge Currents:**

75V DC Stage-5000 amperes

**Maximum Serial Transmission Rate:**

50 k baud

**Series resistance:**

0.219 ohms typical

**Series inductance:**

110 µh typical

**Grounding:**

20 ft (6.1 m) insulated # 10 AWG wire

**Cable Fitting:**

(2) nylon strain relief for 0.079-0.236 in (2.0-6.0 mm) diameter cable

**Enclosure:**

Fiberglass-Reinforced Polyester (FRP) NEMA 4X, maximum 40 psi washdown

**Operating Temperature:**

14°F to 104°F (-10°C to 40°C)

**Circuit Board:**

6.75 x 4.75 in (171.5 x 120.7 mm) with anti-fungal coating

**Dimensions:**

7.63 W x 6.63 H x 3.25 in D (193.8 W x 168.3 H x 82.6 mm D)



## Part Number/Price

PART #	DESCRIPTION	PRICE
21134	UJB3T6	\$350.00

## Options/Accessories

PART #	DESCRIPTION	PRICE
21135	6-channel load cell transient protector, board only	\$250.00

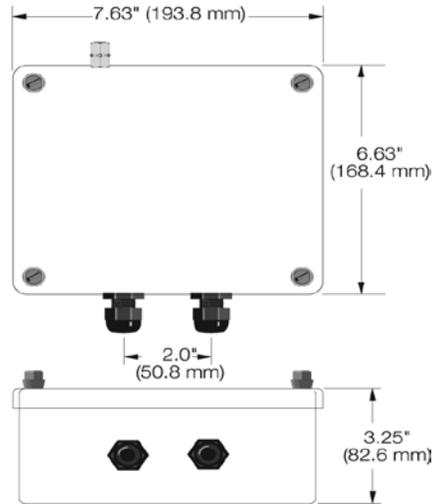

# TP232 RS-232

High Energy Serial Protection

## Standard Features:

- Two metal mounting brackets
- Three stages of protection: gas discharge tube, series resistor and Transient Voltage Suppressor (TVS)
- Two terminal posts for ground
- RS-232 high energy surge protector
- Terminal blocks for transmit, receive, request to send, clear to send and signal ground

## Applications:

- Indicators
- Remote displays
- Printers
- Computers
- PLC

## Specifications:

**Clamping Voltage (Stage One):**  
72V DC minimum, 108V DC maximum

**Series Resistance (Stage Two):**  
2.7 Ohms

**Clamping Voltage (Stage Three):**  
14.3V minimum, 15.7V maximum

**Clamping Time:**  
Less than  $5 \times 10^{-9}$  seconds

**Connectors:**  
5 position terminal blocks

**Dimensions:**  
Approximately 4.5 L x 3.3 W x 1.8 in H (114.3 L x 83.8 W x 45.7 mm H)

**Weight:**  
Approximately 0.42 lb (0.19 kg)

**Approvals:**  
CE marked



## Part Number/Price

PART #	DESCRIPTION	PRICE
69201	TP232	\$175.00

## Options/Accessories

PART #	DESCRIPTION	PRICE
17778	12 in Ground strap	\$10.25
17781	24 in Ground strap	13.25
69516	Additional installation manual	6.00

# Ranger 1

## Standard Features:

- ABS plastic case, weighs less than 1 lb
- Large vernier knob, smooth 10 turn potentiometer
- Ideal tool for troubleshooting a scale system, bench testing stability of indicators and setpoint simulation
- Binding posts are color coded to ISA S37.8 standard

## Specifications:

**Variable Range:**

0-3 mV/V

**Impedance:**

700 ohms nominal

**Connectors:**

Binding posts suitable for banana plug or 14 gauge wire

**Temperature Coefficient:**

±100 ppm/ °C

**Dimensions:**

4.5 L x 3.5 W x 1.25 in H  
(114.3 W x 88.9 H x 31.8 mm D)



## Part Number/Price

PART #	DESCRIPTION	PRICE
68029	Ranger 1 Variable Range Simulator	\$145.00

## Options/Accessories

PART #	DESCRIPTION	PRICE
21116	Cable with banana plugs	\$55.00

# Ranger 3

## Standard Features:

- ABS plastic case, weighs less than 1 lb
- Fixed rotary switch, -0.5 mV/V to 4.5 mV/V in 9 steps of .5 mV/V per step
- Ideal tool for calibrating the indicator A-D offset and gain setting
- A-D calibration steps for -0.5 mV/V for offset and 4.5 mV/V for gain
- Used in testing, troubleshooting and calibrating digital weight indicators
- Binding posts are color coded to ISA S37.8 standard

## Specifications:

**Fixed Steps:**

-0.5 mV/V-4.5 mV/V range

**Impedance:**

350 ohms nominal

**Nonlinearity:**

Less than .02%

**Connectors:**

Binding posts-suitable for banana plug or 14 gauge wire

**Temperature Coefficient:**

±5 ppm/ °C

**Dimensions:**

4.5 L x 3.5 W x 1.25 in H  
(114.3 W x 88.9 H x 31.8 mm D)



## Part Number/Price

PART #	DESCRIPTION	PRICE
68030	Ranger 3 Calibration Simulator	\$360.00

## Options/Accessories

PART #	DESCRIPTION	PRICE
21116	Cable with banana plugs	\$55.00



# Transducer Simulator 4

## Standard Features:

- Designed for high accuracy
- Sealed lid with neoprene o-ring. If secured properly, the Transducer Simulator 4 is completely waterproof
- Dustproof and crush tested to 500 lb
- Four operational modes including vernier adjustment, calibrated adjustment, 0.25 mV offset and 0.50 mV offset
- Ideal for setpoint or batching simulation

## Specifications:

### Maximum Voltage:

15V

### Bridge Type:

175 ohm star

### Linearity:

Less than  $\pm .02\%$  full scale

### Temperature Coefficient:

Absolute 5 ppm/ °C; Tracking less than 0.5 ppm/°C

### Variable Ranges:

Choose any fixed setting  $\pm 0.25$  mV or 0.50 mV through a 10-turn wire-wound potentiometer with locking clutch

### Load Factors:

Simulates 1, 2, 3, 4 or 8 350-ohm load cells or 2, 4, 6, 8 or 16 700-ohm load cells

### Calibrated Offset:

+0.25 mV/V for use with digitally calibrated meters requiring positive dead load for calibration

### Connectors:

Six-way binding posts, suitable for loose wires or banana jacks



## Part Number/Price

PART #	DESCRIPTION	PRICE
22513	Simulator 4	\$725.00

## Options/Accessories

PART #	DESCRIPTION	PRICE
21116	Cable with banana plugs	\$55.00

# Ranger 5

## Standard Features:

- ABS plastic case, weighs less than 1 lb
- Fixed rotary switch, -0.5 mV/V to 4.5 mV/V in 9 steps of .5 mV/V per step
- 10 turn vernier with locking graduated dial
- Vernier selection of 4 ranges: Off, Fine, Medium and Coarse
- Ideal tool for calibrating indicator A-D offset and gain setting
- A-D calibration steps for -0.5 mV/V for offset and 4.5 mV/V for gain
- Used in testing, troubleshooting and calibrating digital weight indicators
- Binding posts are color coded to ISA S37.8 standard

## Specifications:

### Fixed Steps:

-0.5 mV/V-4.5 mV/V range

### Vernier:

Variable range: up to 0.5 mV/V, up to 1 mV/V, up to 1.5 mV/V

### Impedance:

350 ohms nominal

### Nonlinearity:

Less than .02%

### Connectors:

Binding posts suitable for banana plug or 14 gauge wire

### Temperature Coefficient:

$\pm 5$  ppm/ °C

### Dimensions:

4.5 L x 3.5 W x 1.25 in H (114.3 W x 88.9 H x 31.8 mm D)



## Part Number/Price

PART #	DESCRIPTION	PRICE
68031	Ranger 5 Calibration Simulator	\$460.00

## Options/Accessories

PART #	DESCRIPTION	PRICE
21116	Cable with banana plugs	\$55.00

# Ranger 7



## Standard Features:

- Designed for high resolution
- Used in high precision testing, troubleshooting and calibrating of digital weight indicators
- Switchable offset
- Painted die cast enclosure

## Specifications:

### Vernier:

Two ranges; one is equal to the sum of the 0.05 mV/V switch and the 0-0.5 mV/V switch. The other is the sum of the 0.5 mV/V, 0.1 mV/V and 0.01 mV/V switches

### Load Impedance:

Three settings: X0.5= 700Ω, X1= 350Ω (one standard load cell), X4= 87.5Ω (four load cell platform)

### Linearity:

± 0.01% + 1μV

### Connectors:

Low Thermal Electronics, Type 2758 precision gold plated binding posts Standard banana jacks or 14 AWG wire

### Temperature Coefficient:

5 ppm/ °C

### Zero Offset:

± 0.0005 mV/V

### Output Range:

0-3 mV/V in 0.01 mV/V steps

### LED Annunciators:

- EXC +
- EXC -
- Offset ON
- 0.5 mV/V
- 0.1 mV/V



## Part Number/Price

PART #	DESCRIPTION	PRICE
157323	Ranger 7 High Resolution Calibration Simulator	\$680.00

## Options/Accessories

PART #	DESCRIPTION	PRICE
21116	Cable with banana plugs	\$55.00

# Load Cells/Weigh Modules

## Table of Contents

<b>SURVIVOR Paramounts® HE</b> .....	<b>472</b>	<b>RL1600 Series</b> .....	<b>520</b>
Medium-Capacity Weigh Module Systems		Cast Iron	
<b>RL 1700HE</b> .....	<b>474</b>	<b>RL1600 Series</b> .....	<b>522</b>
Light-to Medium-Capacity Weigh Modules		Mild Steel	
<b>RL1600 HE</b> .....	<b>476</b>	<b>RL1600 Series</b> .....	<b>524</b>
Medium-Capacity Weigh Modules		Stainless Steel	
<b>RL1855 HE</b> .....	<b>478</b>	<b>MVS Mount/MVS</b> .....	<b>526</b>
Medium-Capacity Weigh Modules		Conversion Kit	
<b>RL2100 HE</b> .....	<b>480</b>	<b>TSA Truck Scale Assembly</b> .....	<b>528</b>
Heavy-Capacity Weigh Modules		Rice Lake Weighing Systems	
<b>ITCM</b> .....	<b>482</b>	<b>Translink™ Parallel Link Truck Scale Assembly</b> .....	<b>530</b>
Isolated Tension Cell Modules		Rice Lake Weighing Systems	
<b>ITCM SS</b> .....	<b>484</b>	<b>Motor Truck Scale Electronic Conversion Kit</b> .....	<b>532</b>
Stainless Steel Isolated Tension Cell Modules		Rice Lake Weighing Systems	
<b>ITCM HE</b> .....	<b>486</b>	<b>MagnaMount®</b> .....	<b>534</b>
Stainless Steel, Welded-Seal NTEP-Approved Isolated Tension Cell Modules		Tank, Truck and Railroad Track Assembly	
<b>RL50210 TA</b> .....	<b>488</b>	<b>Mettler Toledo™ DigiTOL® Retrofit Kit</b> .....	<b>536</b>
50-500lb Capacity Mini Tank Weighing Module		Stainless Steel, Rice Lake Weighing Systems/Flintec	
<b>RL50210 TA</b> .....	<b>490</b>	<b>Electronic Floor Scale Underdeck Kits</b> .....	<b>538</b>
1000-2500lb Capacity Mini Tank Weighing Module		<b>RL20000</b> .....	<b>539</b>
<b>Paramounts® EP</b> .....	<b>492</b>	S-Beam	
Environmentally Protected Mild Steel, Light-to Medium-Capacity Tank Weighing Systems		S-Beam	
<b>Paramounts® HS</b> .....	<b>494</b>	<b>RL20000 SS</b> .....	<b>541</b>
Hermetically Sealed Load Cells Mild Steel, Light to-Medium Capacity Tank Weighing Systems		S-Beam	
<b>RLBTM Mild/Stainless</b> .....	<b>496</b>	Stainless Steel, NTEP 1:10,000 Class III Single Cell	
Steel Weigh Modules		<b>RL20000 ST</b> .....	<b>543</b>
<b>RL1800 Series</b> .....	<b>498</b>	S-Beam	
Mild Steel/Stainless Steel Weigh Modules		<b>RL20001</b> .....	<b>544</b>
<b>RL1900 Series</b> .....	<b>500</b>	S-Beam	
Stainless Steel Weigh Modules		<b>RL20001 HE</b> .....	<b>545</b>
<b>RLTM</b> .....	<b>502</b>	S-Beam	
Stainless Steel Tank Weigh Module		<b>RLETS</b> .....	<b>546</b>
<b>RL9000TWM Series</b> .....	<b>504</b>	S-Beam	
Tank, Hopper and Vessel Weighing Assembly		<b>RL30000</b> .....	<b>547</b>
<b>RL9000TWM-HT</b> .....	<b>508</b>	Single-Ended Beam	
Tank, Hopper and Vessel Weighing Module		<b>RL30002 Thru Hole</b> .....	<b>548</b>
<b>RL2200 Series</b> .....	<b>510</b>	Single-Ended Beam	
Tank, Hopper and Vessel Weighing Assembly		<b>RLH35</b> .....	<b>549</b>
<b>RL2200 SS Series</b> .....	<b>512</b>	Single-Ended Beam	
Stainless Steel, Tank, Hopper and Vessel Weighing Assembly		<b>RL39123</b> .....	<b>550</b>
<b>EZ Mount 1</b> .....	<b>514</b>	Single-Ended Beam	
Mild Steel		<b>RL30745</b> .....	<b>551</b>
<b>EZ Mount 1</b> .....	<b>516</b>	Single-Ended Beam	
Stainless Steel		<b>RLBLC</b> .....	<b>552</b>
<b>EZ Mount 1 HE</b> .....	<b>518</b>	Single-Ended Beam	
Stainless Steel, Hermetically Sealed		<b>RL35023</b> .....	<b>553</b>
		Single-Ended Beam	
		<b>RL35023S</b> .....	<b>554</b>
		Single-Ended Beam	
		<b>RL35083</b> .....	<b>555</b>
		Single-Ended Beam	
		<b>RL35082</b> .....	<b>556</b>
		Single-Ended Beam	

**ESPAÑOL** | Visit [ricelake.com/spanish](http://ricelake.com/spanish) to see all RLWS materials available in Spanish

Product names, logos, brands, and other trademarks featured or referred to within this publication are the property of their respective trademark holders.

# Load Cells/Weigh Modules

## Table of Contents

<b>RLETB</b> .....	<b>557</b>	<b>RL75114-50K</b> .....	<b>583</b>
Single-Ended Beam		Rocker Column	
<b>RLHTO</b> .....	<b>558</b>	<b>RL8C2P1SS</b> .....	<b>584</b>
Single-Ended Beam		Compression Canister	
<b>RLSSB</b> .....	<b>559</b>	<b>RL90000</b> .....	<b>585</b>
Single-Ended Beam		Compression* Disk	
<b>RLSB250/RLSB250T</b> .....	<b>560</b>	<b>RLPC6</b> .....	<b>586</b>
Single-Ended Beam		Single Point	
<b>RLSB2L</b> .....	<b>561</b>	<b>RLPWM15HE</b> .....	<b>587</b>
Single-Ended Beam		Single Point	
<b>RL50210</b> .....	<b>562</b>	<b>RLPWM15</b> .....	<b>588</b>
Single-Ended Beam		Single Point	
<b>RL50210SS</b> .....	<b>563</b>	<b>RLPCBC-60</b> .....	<b>589</b>
Single-Ended Beam		Single Point	
<b>RL60040SST</b> .....	<b>564</b>	<b>RL1521A</b> .....	<b>590</b>
Single-Ended Beam		Single Point	
<b>RL40BBS</b> .....	<b>565</b>	<b>RL1010</b> .....	<b>591</b>
Single-Ended Beam		Potted and Unpotted Single Point	
<b>RLHBB</b> .....	<b>566</b>	<b>RLSP4</b> .....	<b>592</b>
Single-Ended Beam		Single Point	
<b>RL32011WB-L</b> .....	<b>567</b>	<b>RLPWM12</b> .....	<b>593</b>
Single-Ended Beam		Single Point	
<b>RL32011WB-T</b> .....	<b>568</b>	<b>RLPWM16</b> .....	<b>594</b>
Single-Ended Beam		Single Point	
<b>RL70000</b> .....	<b>569</b>	<b>RL1042</b> .....	<b>595</b>
Double-Ended Beam		Single Point	
<b>RL70000 SS</b> .....	<b>570</b>	<b>RL1040</b> .....	<b>596</b>
Double-Ended Beam		Potted and Unpotted Single Point	
<b>RL71000 HE</b> .....	<b>571</b>	<b>RL1140</b> .....	<b>597</b>
Double-Ended Beam		Potted Single Point	
<b>RL72010MH</b> .....	<b>572</b>	<b>RL1380</b> .....	<b>598</b>
Double-Ended Beam		Single Point	
<b>RL75016</b> .....	<b>573</b>	<b>RL1385</b> .....	<b>599</b>
Double-Ended Beam		Single-Point	
<b>RL75016 SS</b> .....	<b>574</b>	<b>RL1260</b> .....	<b>600</b>
Double-Ended Beam		Single Point	
<b>RL75016 WHE</b> .....	<b>575</b>	<b>RL1250</b> .....	<b>601</b>
Double-Ended Beam		Potted Single Point	
<b>RL75058</b> .....	<b>576</b>	<b>RLFLS</b> .....	<b>602</b>
Double-Ended Beam		Potted Single Point	
<b>RL75060S</b> .....	<b>577</b>	<b>RLBLP</b> .....	<b>603</b>
Double-Ended Beam		Planar Beam	
<b>RL75223</b> .....	<b>578</b>	<b>RL2010</b> .....	<b>604</b>
Double-Ended Beam		Tension Link	
<b>RLDB50000S</b> .....	<b>579</b>		
Double-Ended Beam			
<b>RL75040</b> .....	<b>580</b>		
Double-Ended Beam			
<b>RLCSP1</b> .....	<b>581</b>		
Compression Canister			
<b>RLSCA-50K</b> .....	<b>582</b>		
Rocker Column			



# SURVIVOR Paramounts® HE

Medium-Capacity Weigh Module Systems



*Picture is a representation of actual product*

Consisting of three different weigh module designs, the Paramounts system offers superior accuracy, even in applications with extreme expansion, contraction and vibration. The fixed-pin module acts as the vessel's primary reference point, enabling rotation. A single side-stop module is then paired with the fixed-pin module to permit mechanical expansion and contraction in one direction. The vessel then becomes a high-accuracy weighing system with the addition of one to six free-sliding modules. This system offers the free motion necessary to eliminate unwanted mechanical side loads, as well as the strength needed to keep the vessel in check. This gives the Paramounts system its industry-leading reputation for exceptional accuracy in unfriendly environments.

Integral jacking/shipping bolts enhance safety by preventing accidental lift-off, facilitate quick field removal of load cells and eliminate load cell damage during transportation. Matched outputs and field-replaceable cable simplify installation and enhance serviceability. As a system, Paramounts represent the ultimate combination of convenience, accuracy and control.

## Standard Features

- Capacities (per module): 520 lb-22,500 lb (2.3 kN/102.1 kg-100 kN/10,205.9 kg)
- All stainless steel construction
- Bolt-in-place design; module bolts directly to tank leg without requiring additional load buttons or mounting plates
- Hermetically sealed stainless steel load cells
- Load cell outputs are matched to  $\pm 0.07\%$ , minimizing maintenance costs
- Unique design allows for thermal expansion/contraction
- Low-profile, self-checking design
- Jacking screw allows empty vessel to be lifted clear of load cell for maintenance
- Unique patented blind load hole technology minimizes unwanted side and eccentric loading
- Vessel is free to slide laterally on PTFE-coated surfaces
- Two-year limited warranty

## Applications

- Medium-capacity, high-vibration mixers, blenders and tanks in temperature extremes
- Chemical batching/blending
- Pharmaceutical processing
- Food processing
- Petroleum refining and batching

## Optional Features

- NTEP Certified load cells available: capacities 1125-11,250 lb
- OIML-certified load cells available: capacities 1125-11,250 lb

## Complete Kit Includes

- 1 JB4SS NEMA 4X stainless steel signal trim junction box
- 1 fixed-pin module, 1 side-stop module, and 1 or 2 free-sliding assemblies. Each module is complete with a FLINTEC SB4 or SB10 (520 lb) stainless steel hermetically sealed load cell
- 25' of our Hostile Environment EL147HE SURVIVOR® load cell cable

## Load Cell Certifications



IP66/68

*NOTE: Check with your local Weights and Measure officials for suitability in Legal for Trade applications.*

# SURVIVOR Paramounts® HE

Medium-Capacity Weigh Module Systems

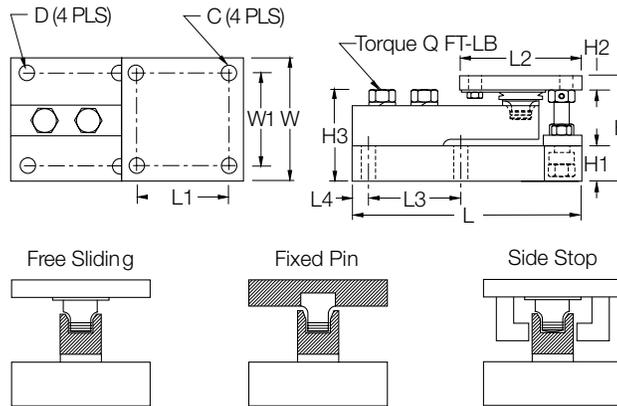

## Dimensions

RATED CAPACITY	C	D	H	H1	*H2	**H2	H3	L	L1	L2	L3	L4	W	W1	Q (FT- LB)	
<b>lb/inches</b>																
520 (2.3 kN)	.375	.437	3.49	1.00	.50	.75	2.98	7.51	3.00	4.00	3.00	.50	4.00	3.00	65	
1125-5200 (5-23 kN)	.437	.437	3.58	1.25	.50	.75	3.06	7.51	3.00	4.00	3.00	.50	4.00	3.00	65	
11,250 (50 kN)	.562	.562	4.66	1.50	.62	1.00	4.09	9.19	3.87	5.00	3.87	.56	5.00	3.87	295	
22,500 (100 kN)	.688	.688	6.41	2.00	.75	1.25	5.73	11.46	4.75	6.00	4.75	.69	6.00	4.75	515	
<b>kg/mm</b>																
236.1	9.5	11.1	88.6	25.4	12.7	19.1	75.7	190.8	76.2	101.6	76.2	12.7	101.6	76.2		
510.8-2360	11.1	11.1	90.9	31.8	12.7	19.1	77.7	190.8	76.2	101.6	76.2	12.7	101.6	76.2		
5107.5	14.3	14.3	118.4	38.1	15.7	25.4	103.9	233.4	98.3	127.0	98.3	14.2	127.0	98.3		
10,215.0	17.5	17.5	162.8	50.8	19.1	31.8	145.5	291.1	120.7	152.4	120.7	17.5	152.4	120.7		

kN = Kilonewtons

\* Side Stop and Free Sliding Units

\*\* Fixed Pin Units

## Order Information

LOAD RATING (PER MODULE)	PART #	PRICE
<b>NTEP/OIML C3 3-Module Kit</b>		
1125 lb (5 kN/510.8 kg)	29883	\$3,395.00
2250 lb (10 kN/1021.5 kg)	29884	3,395.00
5200 lb (23 kN/2360.8 kg)	29885	3,395.00
11,250 lb (50 kN/5107.5 kg)	29886	4,595.00
<b>NTEP/OIML C3 4-Module Kit</b>		
1125 lb (5 kN/510.8 kg)	29879	4,495.00
2250 lb (10 kN/1021.5 kg)	29880	4,495.00
5200 lb (23 kN/2360.8 kg)	29881	4,495.00
11,250 lb (50 kN/5107.5 kg)	29882	5,795.00

## Order Information

LOAD RATING (PER MODULE)	PART #	PRICE
<b>Non-NTEP 3-Module Kit</b>		
520 lb (2.3 kN/236.1 kg)	38207	\$3,840.00
1125 lb (5 kN/510.8 kg)	17991	3,295.00
2250 lb (10 kN/1021.5 kg)	17992	3,295.00
5200 lb (23 kN/2360.8 kg)	17993	3,295.00
11,250 lb (50 kN/5107.5 kg)	17994	4,295.00
22,500 lb (100 kN/10,215.0 kg)	17995	4,895.00
<b>Non-NTEP 4-Module Kit</b>		
520 lb (2.3 kN/236.1 kg)	38208	5,025.00
1125 lb (5 kN/510.8 kg)	17998	4,295.00
2250 lb (10 kN/1021.5 kg)	17999	4,295.00
5200 lb (23 kN/2360.8 kg)	18000	4,295.00
11,250 lb (50 kN/5107.5 kg)	18001	5,395.00
22,500 lb (100 kN/10,215.0 kg)	18002	6,795.00
*Conduit Adapter, 1/2-14 NPT	17703	35.00

\*Must be factory installed

## RL 1700HE

Light-to Medium-Capacity Weigh Modules

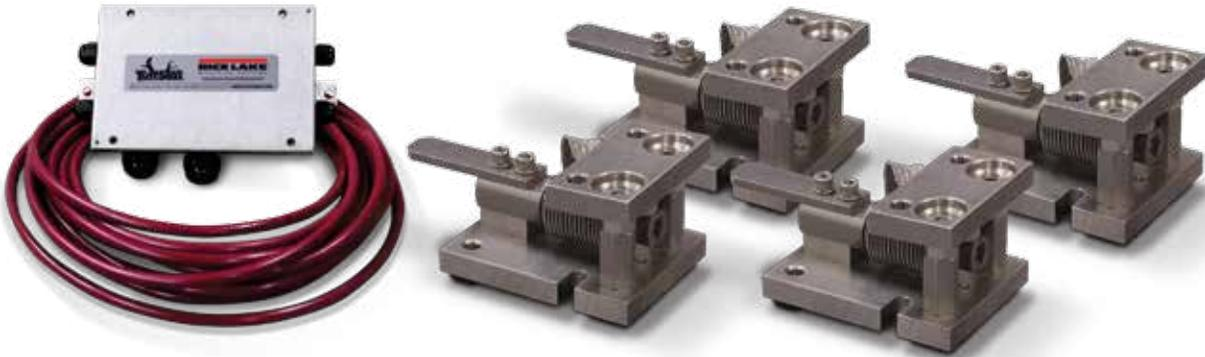

*Picture is a representation of actual product*

The 1700HE offers precision-machined, weldless construction to maximize pressure washdown cleaning effectiveness. This design, coupled with integral jacking/shipping bolts, eases installation and minimizes maintenance costs. OIML C3-certified load cells in capacities from 5 kg to 5,000 kg provide accurate, consistent weightments. Ideal for multi-ingredient micro-batching applications, the 1700HE provides exceptional performance in hostile environments. The unique design of the 1700HE isolates the load cell from side loads, overloads, minimizing load cell mechanical damage and eliminating the need for extraneous hardware. The 1700HE offers a guaranteed waterproof rating to ensure reliable performance in moisture-laden environments.

### Standard Features

- All stainless steel construction
- Hermetically sealed, stainless steel load cells, IP66/68, guaranteed waterproof
- OIML Certified load cells from 5 kg-5,000 kg
- Bolt-in-place design; module bolts directly to tank leg without requiring additional load buttons or mounting plates
- Self-checking with lift-off/tip-over protection and jacking/shipping bolts
- Load cell is isolated from overload in all directions
- Weldless construction retains less residue and allows fast, thorough cleaning
- Two-year limited warranty

### Applications

- Multi-ingredient micro-batching
- Meat and poultry processing
- Chemical batching/blending
- Dye/ink blending

### Complete Kit Includes

- 1 JB4SS NEMA 4X stainless steel signal-trim junction box
- 3 or 4 1700HE stainless steel compression mounts
- 3 or 4 RLHBB (5-250 kg) or RLHTO (500-5000 kg) stainless steel, hermetically sealed single-ended beam load cells
- 25' of our Hostile Environment EL147HE SURVIVOR® load cell cable

### Load Cell Certifications



Available upon request



# RL 1700HE

Light-to Medium-Capacity Weigh Modules

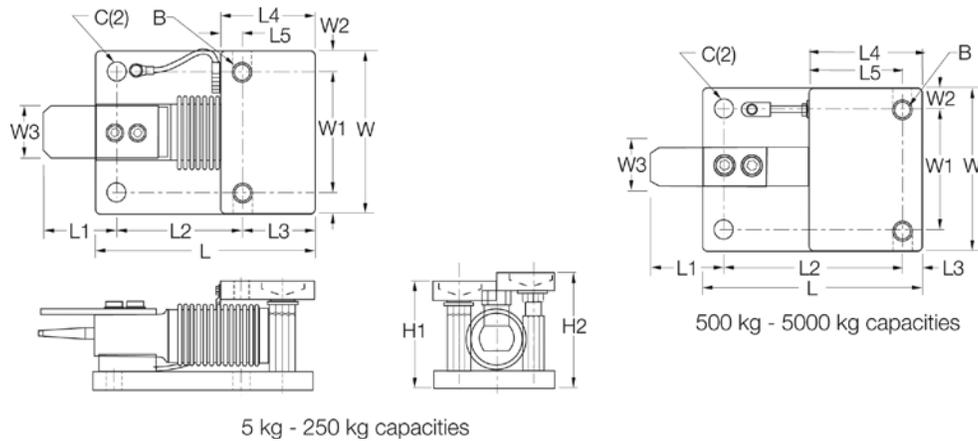

## Dimensions

RATED CAPACITY	C	B	*H1	**H2	L	L1	L2	L3	L4	L5	W	W1	W2	W3
<b>kg/mm</b>														
5-250	12.9	1/2-20 UNF	80.0	86.1	131.8	64.0	76.0	42.0	56.0	14.0	96.0	70.0	13.0	25.4
500-2000	20.0	5/8-18 UNF	101.6	109.1	165.0	70.0	130.0	15.0	80.0	64.5	110.0	70.0	20.0	30.0
5000	20.0	3/4-10 UNF	135.0	143.0	215.0	81.0	161.0	20.0	90.0	70.5	150.0	90.0	30.0	40.0
<b>lb/inches</b>														
11-550	.40	1/2-20 UNC	3.13	3.39	5.19	2.52	2.99	1.65	2.20	.55	3.99	2.76	.51	1.00
1100-4400	.78	5/8-18 UNC	4.00	4.32	6.50	2.76	5.12	.59	3.15	2.54	4.33	2.76	.79	1.18
11,000	.78	3/4-10 UNC	5.31	5.63	8.46	3.19	6.34	.79	3.56	2.78	5.91	3.54	1.18	1.57

\* In weighing position

\*\* In jacked-up position for load cell shipping or removal

## Order Information

LOAD RATING (PER MODULE)	PART #	PRICE
<b>OIML C3-Certified Load Cells Included</b>		
5 kg (11.0 lb)	32687	\$825.00
10 kg (22.0 lb)	32688	825.00
20 kg (44.1 lb)	32689	825.00
50 kg (110.2 lb)	32690	825.00
100 kg (220.5 lb)	32691	825.00
200 kg (440.9 lb)	32692	825.00
250 kg (551.2 lb)	32693	825.00
500 kg (1102.3 lb)	32974	995.00
1000 kg (2204.6 lb)	32973	995.00
2000 kg (4,409.2 lb)	32972	995.00
5000 kg (11,023.1 lb)	32971	1,225.00

## Order Information

LOAD RATING (PER MODULE)	PART #	PRICE
<b>3-Module Kit</b>		
5 kg (11.0 lb)	32920	\$2,675.00
10 kg (22.0 lb)	32921	2,675.00
20 kg (44.1 lb)	32922	2,675.00
50 kg (110.2 lb)	32923	2,675.00
100 kg (220.5 lb)	32924	2,675.00
200 kg (440.9 lb)	32925	2,675.00
250 kg (551.2 lb)	32926	2,675.00
500 kg (1102.3 lb)	32980	3,185.00
1000 kg (2204.6 lb)	32981	3,185.00
2000 kg (4,409.2 lb)	32982	3,185.00
5000 kg (11,023.1 lb)	32983	3,995.00
<b>4-Module Kit</b>		
5 kg (11.0 lb)	32927	3,500.00
10 kg (22.0 lb)	32928	3,500.00
20 kg (44.1 lb)	32929	3,500.00
50 kg (110.2 lb)	32930	3,500.00
100 kg (220.5 lb)	32931	3,500.00
200 kg (440.9 lb)	32932	3,500.00
250 kg (551.2 lb)	32933	3,500.00
500 kg (1102.3 lb)	32984	4,180.00
1000kg (2204.6 lb)	32985	4,180.00
2000 kg (4,409.2 lb)	32986	4,180.00
5000 kg (11,023.1 lb)	32987	4,895.00

## RL1600 HE

Medium-Capacity Weigh Modules



Available in configurations with three or four mounting assemblies.  
Picture is a representation of actual product

The RL1600 HE Mounting Module Kit utilizes several Rice Lake Weighing Systems components to provide an unmatched level of performance in tank and hopper weighing applications. The RL1600 HE kit is ideally suited for indoor and outdoor process control operations in the medium-capacity ranges. Each module incorporates self-checking capabilities for thermal expansion and contraction.

Fabricated stainless steel module with  
RL75016 WHE double-ended beam load cell.

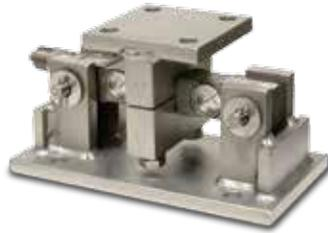

### Standard Features

- Capacities (per module): 1000-25,000 lb (453.6-11,339.8 kg)
- All stainless steel construction
- Self-checking easy-to-use design allows module to be bolted directly to tank leg without requiring additional mounting plates or load buttons
- Hermetically sealed IP66/68 protected load cells
- Double-ended shear beam design, center loaded

### Applications

- Medium-capacity tanks, bins and hoppers
- Bulk material management
- Ingredient batching, mixing and blending

### Complete Kit Includes

- 1 JB4SS NEMA 4X stainless steel signal trim junction box
- 3 or 4 RL1600 stainless steel compression mounts
- 3 or 4 RL75016 WHE stainless steel, hermetically sealed double-ended shear beam load cells
- 25' of our Hostile Environment EL147HE SURVIVOR® load cell cable

### Load Cell Certifications



# RL1600 HE

Medium-Capacity Weigh Modules

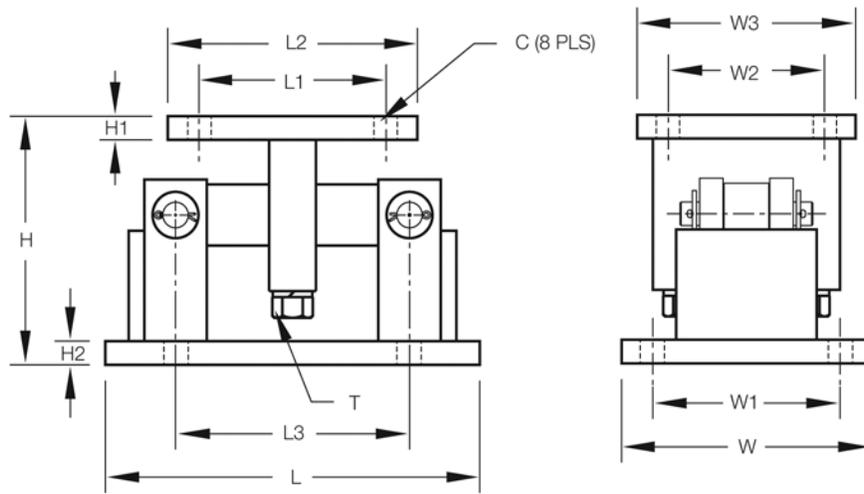

## Dimensions

RATED CAPACITY	C	H	H1	H2	L	L1	L2	L3	T	W	W1	W2	W3
<b>lb/inches</b>													
1000-5000	.56	5.00	.50	.50	9.25	2.75	4.00	6.25	1/2-13 UNC	5.00	3.75	2.75	4.00
10,000-25,000	.78	7.87	.75	.75	12.00	6.00	8.00	7.50	3/4-10 UNC	8.00	6.00	6.00	8.00
<b>kg/mm</b>													
453.6-2268.0	14.2	127.0	12.7	12.7	235.0	69.9	101.6	158.8	1/2-13 UNC	127.0	95.3	69.9	101.6
4535.9-11,339.8	19.8	199.9	19.1	19.1	304.8	152.4	203.2	190.5	3/4-10 UNC	203.2	152.4	152.4	203.2

## Order Information

LOAD RATING (PER MODULE)	PART #	PRICE
<b>3-Module Kit</b>		
1000 lb (453.6 kg)	46723	\$3,895.00
1500 lb (680.4 kg)	119673	3,895.00
2000 lb (907.2 kg)	119675	3,895.00
2500 lb (1134.0 kg)	46724	3,895.00
5000 lb (2268.0 kg)	46725	3,895.00
10,000 lb (4535.9 kg)	46726	5,495.00
15,000 lb (6803.9 kg)	46727	5,495.00
20,000 lb (9071.9 kg)	84664	5,495.00
25,000 lb (11,339.8 kg)	46728	5,495.00
<b>4-Module Kit</b>		
1000 lb (453.6 kg)	46729	4,910.00
1500 lb (680.4 kg)	119674	4,910.00
2000 lb (907.2 kg)	119676	4,910.00
2500 lb (1134.0 kg)	46730	4,910.00
5000 lb (2268.0 kg)	46731	4,910.00
10,000 lb (4535.9 kg)	46732	7,305.00
15,000 lb (6803.9 kg)	46733	7,305.00
20,000 lb (9071.9 kg)	84665	7,305.00
25,000 lb (11,339.8 kg)	46734	7,305.00

## Order Information

LOAD RATING (PER MODULE)	PART #	PRICE
<b>Single Module (Does not include Load Cell)</b>		
1000-5000 lb (453.6-2268.0 kg)	17813	\$565.00
10,000-25,000 lb (4535.9-11,339.8 kg)	17815	1,095.00
<b>Dummy Load Cells (Mild Steel)</b>		
1000-5000 lb (453.6-2268.0 kg)	18236	20.00
10,000-25,000 lb (4535.9-11,339.8 kg)	18237	35.00
<b>Equalizer Pads</b>		
1000 lb-5000 lb	Consult	Consult
10,000 lb-25,000 lb	Consult	Consult

## Shims

	PART #	PRICE
<b>1K-5K</b>		
0.0625	150852	\$3.25
0.125	150853	8.50
0.250	150854	14.25
<b>10K-25K</b>		
0.0625	150855	12.75
0.125	150856	20.50
0.250	150857	57.00
<b>50K-75K</b>		
0.0625	150858	16.25
0.125	150859	26.25
0.250	150861	72.25

Shims match the top plate

## RL1855 HE

Medium-Capacity Weigh Modules



*Picture is a representation of actual product*

The internal height adjustment feature of the RL1855HE reduces the need for shims or external hardware, simplifying installation. The standard conduit adapter allows for connection to conduit for cable protection. With standard NTEP Certified, 1:5000 division class III load cells, the RL1855HE provides an accurate weighing system when properly installed. Highly versatile, the RL1855HE offers worry-free operation in a wide variety of rugged applications.

### Standard Features

- All stainless steel construction
- Welded seal, stainless steel load cells, IP67, guaranteed waterproof
- NTEP Certified load cells, 5000d, Class III Multiple Cell
- Bolt-in-place design; module bolts directly to tank leg without requiring additional load buttons or mounting plates
- Self-checking design with lift-off/tip-over protection
- Two-year limited warranty

### Applications

- Medium-capacity hoppers, bins and tanks
- Chemical batching/blending
- Fertilizer blending

### Optional features

- RL35082 IP66/68 load cells available

### Complete Kit Includes

- 1 JB4SS NEMA 4X stainless steel signal-trim junction box
- 3 or 4 1855HE stainless steel compression mounts
- 3 or 4 RL35082 stainless steel, welded seal single-ended beam load cells
- 25ft of our Hostile Environment EL147HE SURVIVOR® load cell cable

### Load Cell Certifications



*NOTE: Check with your local Weights and Measure officials for suitability in Legal for Trade applications.*

# RL1855 HE

Medium-Capacity Weigh Modules

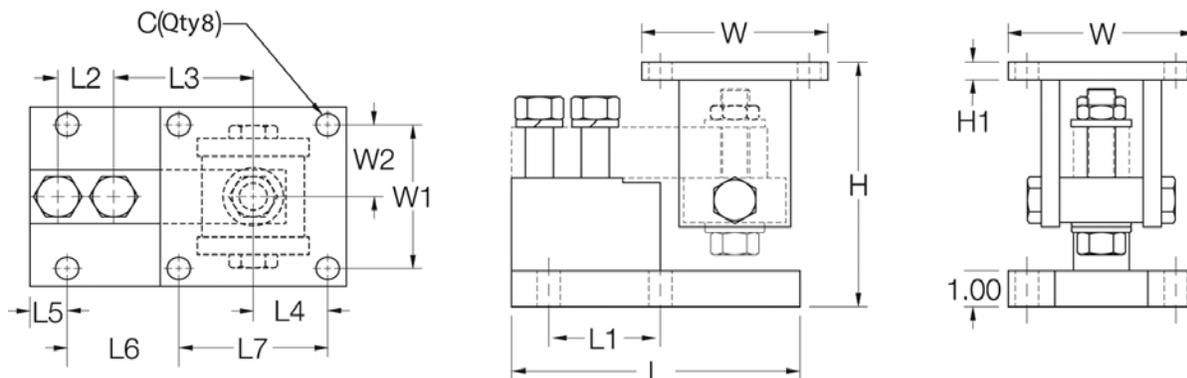

## Dimensions

RATED CAPACITY	C	H MIN/MAX	H1	L	L1	L2	L3	L4	L5	L6	L7	W	W1	W2
<b>lb/inches</b>														
1000-4000	.62	5.25/5.56	.50	6.00	2.00	1.00	3.00	2.00	.68	1.94	4.00	5.00	4.00	2.00
5000-10,000	.62	6.12/6.62	.50	7.75	3.00	1.50	3.75	2.00	1.03	2.97	4.00	5.00	4.00	2.00
<b>kg/mm</b>														
453.6-1814.4	15.8	133.4/141.2	12.7	152.4	50.8	25.4	76.2	50.8	17.3	49.3	101.6	127.0	101.6	50.8
2268.0-4535.9	15.8	155.4/168.1	12.7	196.9	76.2	38.1	95.3	50.8	26.2	75.4	101.6	127.0	101.6	50.8

## Order Information

LOAD RATING (PER MODULE)	PART #	PRICE
<b>Single Modules (Includes Load Cell)</b>		
1000 lb (453.6 kg)	32975	\$895.00
2500 lb (1134.0 kg)	32976	895.00
4000 lb (1814.4 kg)	32977	895.00
5000 lb (2268.0 kg)	32978	995.00
10,000 lb (4535.9 kg)	32979	995.00

## Order Information

LOAD RATING (PER MODULE)	PART #	PRICE
<b>3-Module Kit</b>		
1000 lb (453.6 kg)	30390	\$2,885.00
2500 lb (1134.0 kg)	30388	2,885.00
4000 lb (1814.4 kg)	30386	2,885.00
5000 lb (2268.0 kg)	30384	3,185.00
10,000 lb (4535.9 kg)	30382	3,185.00
<b>4-Module Kit</b>		
1000 lb (453.6 kg)	30389	3,780.00
2500 lb (1134.0 kg)	30387	3,780.00
4000 lb (1814.4 kg)	30385	3,780.00
5000 lb (2268.0 kg)	30383	4,180.00
10,000 lb (4535.9 kg)	30381	4,180.00

## RL2100 HE

Heavy-Capacity Weigh Modules



*Picture is a representation of actual product*

Incorporating an articulating load plate, hardened load pin and double-ended beam load cell into one simple design, the RL2100HE tolerates eccentric loads and side loads of up to 100% of capacity. The RL2100HE comes standard with NTEP Certified, 1:5000 division class IIIIL load cells, yielding up to 0.02% total error. An integral conduit adapter offers added washdown protection. These standard features give the RL2100HE accuracy and dependability in one heavyweight package. The simple load introduction and load cell design provides consistent accuracy in washdown applications, making the RL2100HE ideal for high-capacity hostile environments.

### Standard Features

- All stainless steel construction
- Welded seal, stainless steel load cells, IP67, guaranteed waterproof
- NTEP Certified load cells, 5000d, Class IIIIL/10,000d, Class IIIIL Multiple Cell
- Bolt-in-place design; module bolts directly to tank leg without requiring additional load buttons or mounting plates
- Self-checking design with lift-off/tip-over protection
- Two-year limited warranty

### Applications

- Heavy-capacity tanks, blenders, reactors and bulk inventory management
- Petroleum refining process control
- Chemical blending/batching

### Complete Kit Includes

- 1 JB4SS NEMA 4X stainless steel signal-trim junction box
- 3 or 4 2100HE stainless steel compression mounts
- 3 or 4 RL75060S stainless steel, welded seal double-ended beam load cells
- 25' of our Hostile Environment EL147HE SURVIVOR® load cell cable

### Load Cell Certifications



*NOTE: Check with your local weights and measure officials for suitability in Legal for Trade applications.*

# RL2100 HE

Heavy-Capacity Weigh Modules

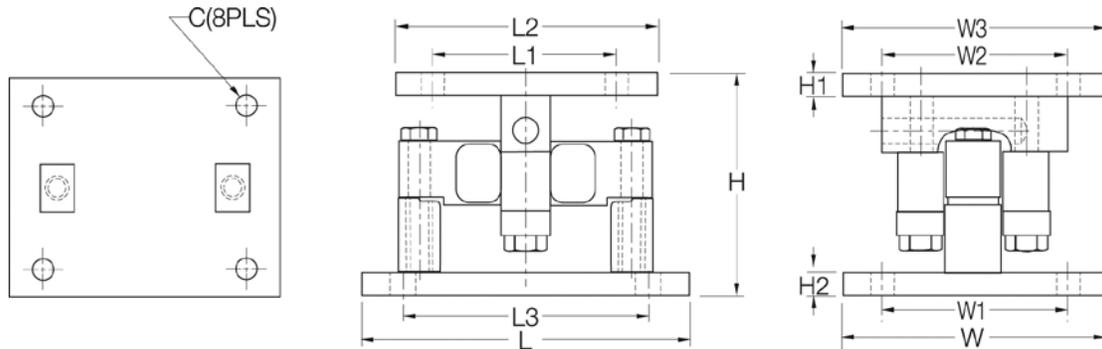

## Dimensions

RATED CAPACITY	C	H	H1	H2	L	L1	L2	L3	W	W1	W2	W3
<b>lb/inches</b>												
20,000-25,000	.78	6.85	.75	.75	10.00	6.00	8.00	7.50	8.00	6.00	6.00	8.00
35,000-100,000	1.13	9.42	1.00	1.00	14.00	6.50	9.00	11.50	10.00	7.50	6.50	9.00
<b>kg/mm</b>												
9071.9-11,339.8	19.8	174.0	19.1	19.1	254.0	152.4	203.2	190.5	203.2	152.4	152.4	203.2
15,875.7-45,359.2	28.7	239.3	25.4	25.4	355.6	165.1	228.6	292.1	254.0	190.5	165.1	228.6

## Order Information

LOAD RATING (PER MODULE)	PART #	PRICE
<b>Single Module (Includes Load Cell)</b>		
20,000 lb (9071.8 kg)	32951	\$1,675.00
25,000 lb (11,339.8 kg)	65541	1,675.00
35,000 lb (15,875.7 kg)	32952	2,525.00
50,000 lb (22,679.6 kg)	32953	2,525.00
60,000 lb (27,215.5 kg)	32954	2,525.00
75,000 lb (34,019.4 kg)	32955	2,525.00
100,000 lb (45,359.2 kg)	32956	4,350.00

## Order Information

LOAD RATING (PER MODULE)	PART #	PRICE
<b>3-Module Kit</b>		
20,000 lb (9071.8 kg)	32970	\$5,125.00
25,000 lb (11,339.8 kg)	65984	5,125.00
35,000 lb (15,875.7 kg)	32969	7,695.00
50,000 lb (22,679.6 kg)	32968	7,695.00
60,000 lb (27,215.5 kg)	32967	7,695.00
75,000 lb (34,019.4 kg)	32966	7,695.00
100,000 lb (45,359.2 kg)	32965	12,600.00
<b>4-Module Kit</b>		
20,000 lb (9071.8 kg)	32964	6,850.00
25,000 lb (11,339.8 kg)	65983	6,850.00
35,000 lb (15,875.7 kg)	32963	10,295.00
50,000 lb (22,679.6 kg)	32962	10,295.00
60,000 lb (27,215.5 kg)	32961	10,295.00
75,000 lb (34,019.4 kg)	32960	10,295.00
100,000 lb (45,359.2 kg)	32959	16,695.00

# ITCM

## Isolated Tension Cell Modules

### Standard Features

- Capacities (per module): 100-20,000 lb (45.4-9071.1 kg)
- Clevis mounts with nylon insulating washers
- PTFE-lined rod-end ball joints
- Load cell is completely isolated from stray currents\*
- Grounding strap provides alternative path to ground
- Complete package for ease of installation
- Provides correct load cell loading even in difficult installations
- Lower overall height compared to other isolated tension assemblies
- Zinc plated clevis assemblies

\*Excluding 20,000 lb (9071.9 kg) capacity

### Applications

- Suspended hoppers and tanks
- Mechanical scale conversions
- Use as a single module or in multiples

### Complete Kit Includes

- 3 or 4 ITCM assemblies with RL20000 NTEP Certified S-Beam load cells
- 1 JB4SS NEMA 4X stainless steel signal trim junction box
- 25ft of our Hostile Environment EL147HE SURVIVOR® load cell cable

### Load Cell Certifications



NOTE: Check with your local weights and measure officials for suitability in Legal for Trade applications.

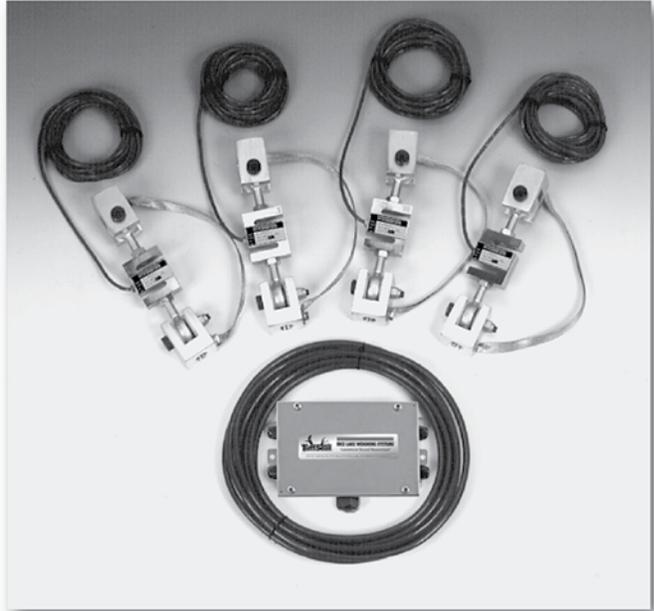
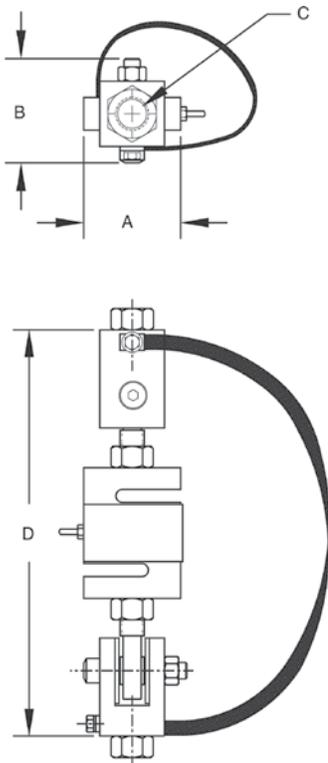

Available in configurations with three or four mounting assemblies.

Picture is a representation of actual product

The ITCM Series utilizes several Rice Lake Weighing Systems components to provide an unmatched level of performance in tank and hopper weighing applications and mechanical scale conversions. The ITCM incorporates clevis and unique rod-end ball joint assemblies to reduce the overall length to less than half of the traditional tension cell mounts, while providing correct load alignment. In addition, the load cell is completely electrically isolated from stray currents, which are a major cause of load cell failure. To complete the design, a grounding strap connects the two clevis assemblies to further provide safety to your load cells.



Module with RL20000 S-Beam load cell.

Important: Read "Load Cell Mounting Hardware Safety Guidelines"



# ITCM

Isolated Tension Cell Modules

## \*Load Rating Dimensions - Inches (mm)      Order Information

LOAD CELL CAPACITY		A		B		C		D		SINGLE MODULE		3-MODULE KIT		4-MODULE KIT	
										Part #	Price	Part #	Price	Part #	Price
100 lb	(45.4 kg)	2.00	(50.8)	1.81	(46.0)	3/8-16 NC	7.00 (ref)	(177.8)	17851	\$450.00	18003	\$1,600.00	18027	\$2,050.00	
100 lb	(45.4 kg)	2.00	(50.8)	1.81	(46.0)	1/2-13 NC	7.00 (ref)	(177.8)	17831	450.00	18004	1,600.00	18028	2,050.00	
150 lb	(68.0 kg)	2.00	(50.8)	1.81	(46.0)	3/8-16 NC	7.00 (ref)	(177.8)	30337	450.00	30357	1,600.00	30359	2,050.00	
150 lb	(68.0 kg)	2.00	(50.8)	1.81	(46.0)	1/2-13 NC	7.00 (ref)	(177.8)	30336	450.00	30358	1,600.00	30360	2,050.00	
200 lb	(90.7 kg)	2.00	(50.8)	1.81	(46.0)	3/8-16 NC	7.00 (ref)	(177.8)	30335	450.00	30361	1,600.00	30363	2,050.00	
200 lb	(90.7 kg)	2.00	(50.8)	1.81	(46.0)	1/2-13 NC	7.00 (ref)	(177.8)	30338	450.00	30362	1,600.00	30364	2,050.00	
250 lb	(113.4 kg)	2.00	(50.8)	1.81	(46.0)	3/8-16 NC	7.00 (ref)	(177.8)	17852	450.00	18005	1,600.00	18029	2,050.00	
250 lb	(113.4 kg)	2.00	(50.8)	1.81	(46.0)	1/2-13 NC	7.00 (ref)	(177.8)	17832	450.00	18006	1,600.00	18030	2,050.00	
500 lb	(226.8 kg)	2.68	(68.1)	2.68	(68.1)	1/2-13 NC	9.50 (ref)	(241.3)	17853	480.00	18007	1,690.00	18031	2,075.00	
500 lb	(226.8 kg)	2.68	(68.1)	2.68	(68.1)	5/8-11 NC	9.50 (ref)	(241.3)	17858	480.00	18008	1,690.00	18032	2,075.00	
500 lb	(226.8 kg)	2.68	(68.1)	2.68	(68.1)	3/4-10 NC	9.50 (ref)	(241.3)	17833	480.00	18009	1,690.00	18033	2,075.00	
750 lb	(340.2 kg)	2.68	(68.1)	2.68	(68.1)	1/2-13 NC	9.50 (ref)	(241.3)	17854	480.00	18010	1,690.00	18034	2,075.00	
750 lb	(340.2 kg)	2.68	(68.1)	2.68	(68.1)	5/8-11 NC	9.50 (ref)	(241.3)	17859	480.00	18011	1,690.00	18035	2,075.00	
750 lb	(340.2 kg)	2.68	(68.1)	2.68	(68.1)	3/4-10 NC	9.50 (ref)	(241.3)	17834	480.00	18012	1,690.00	18036	2,075.00	
1000 lb	(453.6 kg)	2.68	(68.1)	2.68	(68.1)	1/2-13 NC	9.50 (ref)	(241.3)	17855	480.00	18013	1,690.00	18037	2,075.00	
1000 lb	(453.6 kg)	2.68	(68.1)	2.68	(68.1)	5/8-11 NC	9.50 (ref)	(241.3)	17860	480.00	18014	1,690.00	18038	2,075.00	
1000 lb	(453.6 kg)	2.68	(68.1)	2.68	(68.1)	3/4-10 NC	9.50 (ref)	(241.3)	17835	480.00	18015	1,690.00	18039	2,075.00	
1500 lb	(680.4 kg)	2.68	(68.1)	2.68	(68.1)	1/2-13 NC	9.50 (ref)	(241.3)	17856	480.00	18016	1,690.00	18040	2,075.00	
1500 lb	(680.4 kg)	2.68	(68.1)	2.68	(68.1)	5/8-11 NC	9.50 (ref)	(241.3)	17861	480.00	18017	1,690.00	18041	2,075.00	
1500 lb	(680.4 kg)	2.68	(68.1)	2.68	(68.1)	3/4-10 NC	9.50 (ref)	(241.3)	17836	480.00	18018	1,690.00	18042	2,075.00	
2000 lb	(907.2 kg)	2.68	(68.1)	2.68	(68.1)	1/2-13 NC	9.50 (ref)	(241.3)	17857	480.00	18019	1,690.00	18043	2,075.00	
2000 lb	(907.2 kg)	2.68	(68.1)	2.68	(68.1)	5/8-11 NC	9.50 (ref)	(241.3)	17862	480.00	18020	1,690.00	18044	2,075.00	
2000 lb	(907.2 kg)	2.68	(68.1)	2.68	(68.1)	3/4-10 NC	9.50 (ref)	(241.3)	17837	480.00	18021	1,690.00	18045	2,075.00	
2500 lb	(1134.0 kg)	2.68	(68.1)	2.68	(68.1)	5/8-11 NC	9.50 (ref)	(241.3)	17863	480.00	18022	1,690.00	18046	2,075.00	
2500 lb	(1134.0 kg)	2.68	(68.1)	2.68	(68.1)	3/4-10 NC	9.50 (ref)	(241.3)	17838	480.00	18023	1,690.00	18047	2,075.00	
3000 lb	(1360.8 kg)	3.37	(85.6)	3.37	(85.6)	3/4-10 NC	10.50 (ref)	(266.7)	30339	520.00	30365	1,810.00	30366	2,310.00	
5000 lb	(2268.0 kg)	3.37	(85.6)	3.37	(85.6)	3/4-10 NC	12.25 (ref)	(311.2)	17864	695.00	18024	2,340.00	18048	3,030.00	
5000 lb	(2268.0 kg)	3.37	(85.6)	3.37	(85.6)	1-8 NC	12.25 (ref)	(311.2)	17839	695.00	18025	2,340.00	18049	3,030.00	
10,000 lb	(4535.9 kg)	3.37	(85.6)	3.37	(85.6)	1-8 NC	12.25 (ref)	(311.2)	17840	695.00	18026	2,340.00	18050	3,030.00	
15,000 lb	(6803.9 kg)	4.00	(101.6)	4.12	(104.6)	1 1/4-7 NC	18.00 (ref)	(457.2)	17960	1,370.00	30353	4,655.00	30354	5,980.00	
20,000 lb	(9071.9 kg)	5.00	(127.0)	4.12	(104.6)	1 1/2-6 UNC	20.00 (ref)	(508.0)	17961	1,715.00	30355	5,455.00	30356	7,275.00	

\* Load Rating is per module

WEIGH MODULES

www.ricelake.com | Phone: 800-472-6703

RICE LAKE

## ITCM SS

Stainless Steel Isolated Tension Cell Modules

### Standard Features

- Capacities (per module): 100-5,000 lb (45.4-2268.0 kg)
- Clevis mounts with nylon insulating washers
- PTFE-lined rod-end ball joints
- Load cell is completely isolated from stray currents
- Grounding strap provides alternative path to ground
- Complete package for ease of installation
- Provides correct load cell loading even in difficult installations
- Lower overall height compared to other isolated tension assemblies

### Applications

- Suspended hoppers and tanks
- Mechanical scale conversions
- Use as a single module or in multiples

### Complete Kit Includes

- 3 or 4 ITCM assemblies with RL20000 ST NTEP Certified S-Beam load cell
- 1 JB4SS NEMA 4X stainless steel signal trim junction box
- 25 ft of our Hostile Environment EL147HE SURVIVOR® load cell cable

### Load Cell Certifications



*NOTE: Check with your local weights and measure officials for suitability in Legal for Trade applications.*

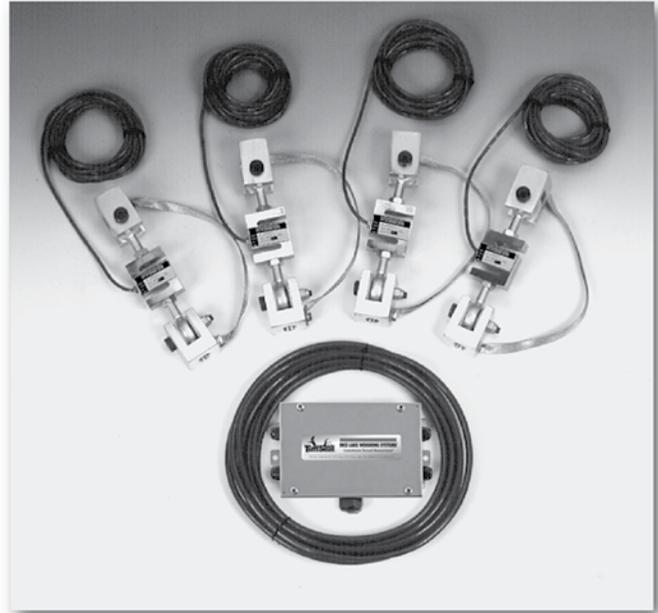

*Available in configurations with three or four mounting assemblies.*

*Picture is a representation of actual product*

The ITCM Series utilizes several Rice Lake Weighing Systems components to provide an unmatched level of performance in tank and hopper weighing applications and mechanical scale conversions. The ITCM SS incorporates clevis and unique rod-end ball joint assemblies to reduce the overall length to less than half of the traditional tension cell mounts, while providing correct load alignment. In addition, the load cell is completely electrically isolated from stray currents, which are a major cause of load cell failure. To complete the design, a grounding strap connects the two clevis assemblies to further provide safety to your load cells.

*Module with RL20000 ST S-Beam load cell.*

*Important: Read "Load Cell Mounting Hardware Safety Guidelines"*



# ITCM SS

Stainless Steel Isolated Tension Cell Modules

## \*Load Rating Dimensions - Inches (mm)

## Order Information

LOAD CELL CAPACITY	A	B	C	D	SINGLE MODULE		3-MODULE KIT		4-MODULE KIT	
					Part #	Price	Part #	Price	Part #	Price
100 lb (45.4 kg)	2.00 (50.8)	1.81 (46.0)	3/8-16 NC	7.00 (ref) (177.8)	46765	\$725.00	46735	\$2,385.00	46751	\$3,015.00
100 lb (45.4 kg)	2.00 (50.8)	1.81 (46.0)	1/2-13 NC	7.00 (ref) (177.8)	46766	725.00	46736	2,385.00	46752	3,015.00
250 lb (113.4 kg)	2.00 (50.8)	1.81 (46.0)	3/8-16 NC	7.00 (ref) (177.8)	46767	725.00	46737	2,385.00	46753	3,015.00
250 lb (113.4 kg)	2.00 (50.8)	1.81 (46.0)	1/2-13 NC	7.00 (ref) (177.8)	46768	725.00	46738	2,385.00	46754	3,015.00
500 lb (226.8 kg)	2.68 (68.1)	2.68 (68.1)	1/2-13 NC	9.50 (ref) (241.3)	46769	725.00	46739	2,385.00	46755	3,015.00
500 lb (226.8 kg)	2.68 (68.1)	2.68 (68.1)	5/8-11 NC	9.50 (ref) (241.3)	46770	725.00	46740	2,385.00	46756	3,015.00
750 lb (340.2 kg)	2.68 (68.1)	2.68 (68.1)	1/2-13 NC	9.50 (ref) (241.3)	46771	725.00	46741	2,385.00	46757	3,015.00
750 lb (340.2 kg)	2.68 (68.1)	2.68 (68.1)	5/8-11 NC	9.50 (ref) (241.3)	46772	725.00	46742	2,385.00	46758	3,015.00
1000 lb (453.6 kg)	2.68 (68.1)	2.68 (68.1)	1/2-13 NC	9.50 (ref) (241.3)	46773	725.00	46743	2,385.00	46759	3,015.00
1000 lb (453.6 kg)	2.68 (68.1)	2.68 (68.1)	5/8-11 NC	9.50 (ref) (241.3)	46774	725.00	46744	2,385.00	46760	3,015.00
2500 lb (1134.0 kg)	2.68 (68.1)	2.68 (68.1)	5/8-11 NC	9.50 (ref) (241.3)	46775	725.00	46745	2,385.00	46761	3,015.00
2500 lb (1134.0 kg)	2.68 (68.1)	2.68 (68.1)	3/4-10 NC	9.50 (ref) (241.3)	46776	725.00	46746	2,385.00	46762	3,015.00
3000 lb (1360.8 kg)	3.37 (85.6)	3.37 (85.6)	3/4-10 NC	10.75 (ref) (273.0)	46777	775.00	46747	2,535.00	46763	3,215.00
5000 lb (2268.0 kg)	3.37 (85.6)	3.37 (85.6)	3/4-10 NC	12.00 (ref) (304.8)	46778	1,365.00	46748	4,305.00	46764	5,675.00

\* Load Rating is per module

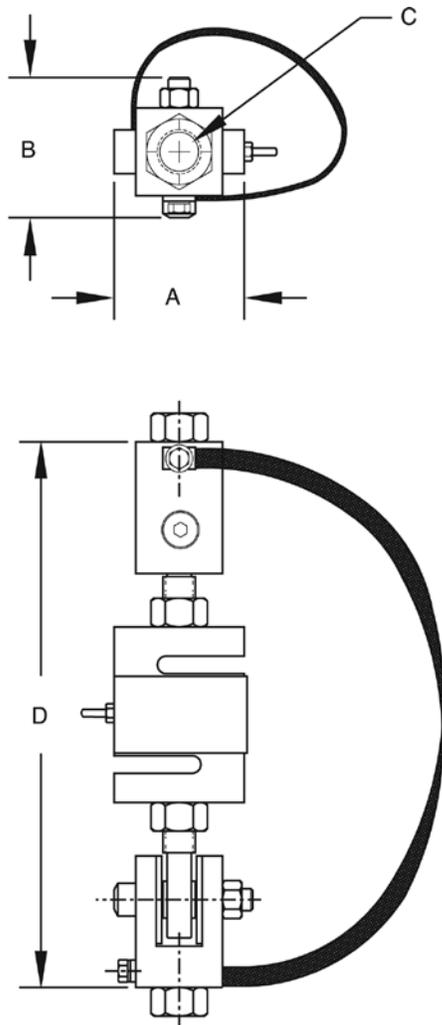

## ITCM HE

Stainless Steel, Welded-Seal NTEP-Approved Isolated Tension Cell Modules

### Standard Features

- Capacities (per module): 500-5,000 lb (226.8-2268.0 kg)
- Clevis mounts with nylon insulating washers
- PTFE-lined rod-end ball joints
- Load cell is completely isolated from stray currents
- Grounding strap provides alternative path to ground
- Complete package for ease of installation
- Provides correct load-cell loading even in difficult installations
- Lower overall height compared to other isolated tension assemblies

### Applications

- Suspended hoppers and tanks
- Mechanical scale conversions
- Use as a single module or in multiples

### Complete Kit Includes

- 3 or 4 ITCM assemblies with RL20001HE Stainless Steel, Welded Seal
- NTEP Certified S-Beam load cells
- 1 JB4SS NEMA 4X stainless steel signal trim junction box
- 25 ft of our Hostile Environment EL147HE SURVIVOR® load cell cable

### Load Cell Certifications



*NOTE: Check with your local weights and measure officials for suitability in Legal for Trade applications.*

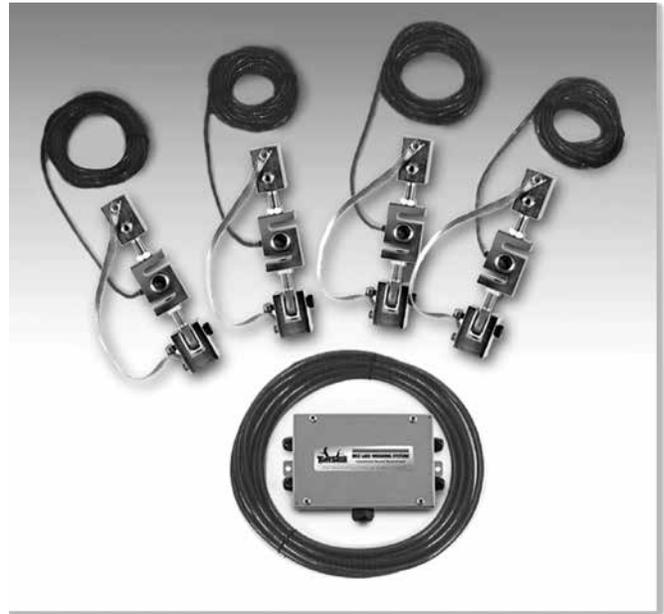

*Available in configurations with three or four mounting assemblies.*

*Picture is a representation of actual product*

The ITCM Series utilizes several Rice Lake Weighing Systems components to provide an unmatched level of performance in tank and hopper weighing applications and mechanical scale conversions. The ITCM HE incorporates clevis and unique rod-end ball joint assemblies to reduce the overall length to less than half of the traditional tension cell mounts, while providing correct load alignment. In addition, the load cell is completely electrically isolated from stray currents, which are a major cause of load cell failure. To complete the design, a grounding strap connects the two clevis assemblies to further provide safety to your load cells.

*Module with RL20001 HE S-Beam load cell.*

*Important: Read "Load Cell Mounting Hardware Safety Guidelines"*



# ITCM HE

Stainless Steel, Welded-Seal NTEP-Approved Isolated Tension Cell Modules

## \*Load Rating Dimensions - Inches (mm)      Order Information

LOAD CELL CAPACITY	A	B	C	D	SINGLE MODULE		3-MODULE KIT		4-MODULE KIT	
					Part #	Price	Part #	Price	Part #	Price
500 lb (226.8 kg)	2.68 (68.1)	2.68 (68.1)	1/2-13 NC	9.50 (ref) (241.3)	46599	\$1,340.00	46561	\$4,020.00	46580	\$5,360.00
500 lb (226.8 kg)	2.68 (68.1)	2.68 (68.1)	5/8-11 NC	9.50 (ref) (241.3)	46600	1,340.00	46562	4,020.00	46581	5,360.00
500 lb (226.8 kg)	2.68 (68.1)	2.68 (68.1)	3/4-10 NC	9.50 (ref) (241.3)	46601	1,340.00	46563	4,020.00	46582	5,360.00
750 lb (340.2 kg)	2.68 (68.1)	2.68 (68.1)	1/2-13 NC	9.50 (ref) (241.3)	46602	1,340.00	46564	4,020.00	46583	5,360.00
750 lb (340.2 kg)	2.68 (68.1)	2.68 (68.1)	5/8-11 NC	9.50 (ref) (241.3)	46603	1,340.00	46565	4,020.00	46584	5,360.00
750 lb (340.2 kg)	2.68 (68.1)	2.68 (68.1)	3/4-10 NC	9.50 (ref) (241.3)	46604	1,340.00	46566	4,020.00	46585	5,360.00
1000 lb (453.6 kg)	2.68 (68.1)	2.68 (68.1)	1/2-13 NC	9.50 (ref) (241.3)	46605	1,340.00	46567	4,020.00	46586	5,360.00
1000 lb (453.6 kg)	2.68 (68.1)	2.68 (68.1)	5/8-11 NC	9.50 (ref) (241.3)	46606	1,340.00	46568	4,020.00	46587	5,360.00
1000 lb (453.6 kg)	2.68 (68.1)	2.68 (68.1)	3/4-10 NC	9.50 (ref) (241.3)	46607	1,340.00	46569	4,020.00	46588	5,360.00
1500 lb (680.4 kg)	2.68 (68.1)	2.68 (68.1)	1/2-13 NC	9.50 (ref) (241.3)	46608	1,340.00	46570	4,020.00	46589	5,360.00
1500 lb (680.4 kg)	2.68 (68.1)	2.68 (68.1)	5/8-11 NC	9.50 (ref) (241.3)	46609	1,340.00	46571	4,020.00	46590	5,360.00
1500 lb (680.4 kg)	2.68 (68.1)	2.68 (68.1)	3/4-10 NC	9.50 (ref) (241.3)	46610	1,340.00	46572	4,020.00	46591	5,360.00
2000 lb (907.2 kg)	2.68 (68.1)	2.68 (68.1)	1/2-13 NC	9.50 (ref) (241.3)	46611	1,340.00	46573	4,020.00	46592	5,360.00
2000 lb (907.2 kg)	2.68 (68.1)	2.68 (68.1)	5/8-11 NC	9.50 (ref) (241.3)	46612	1,340.00	46574	4,020.00	46593	5,360.00
2000 lb (907.2 kg)	2.68 (68.1)	2.68 (68.1)	3/4-10 NC	9.50 (ref) (241.3)	46613	1,340.00	46575	4,020.00	46594	5,360.00
2500 lb (1134.0 kg)	2.68 (68.1)	2.68 (68.1)	5/8-11 NC	9.50 (ref) (241.3)	46614	1,340.00	46576	4,020.00	46595	5,360.00
2500 lb (1134.0 kg)	2.68 (68.1)	2.68 (68.1)	3/4-10 NC	9.50 (ref) (241.3)	46615	1,340.00	46577	4,020.00	46596	5,360.00
3000 lb (1360.8 kg)	3.37 (85.6)	3.37 (85.6)	3/4-10 NC	10.00 (ref) (254.0)	46616	1,340.00	46578	4,020.00	46597	5,360.00
5000 lb (2268.0 kg)	3.37 (85.6)	3.37 (85.6)	3/4-10 NC	12.62 (ref) (320.5)	46617	2,010.00	46579	6,030.00	46598	8,040.00

\* Load Rating is per module

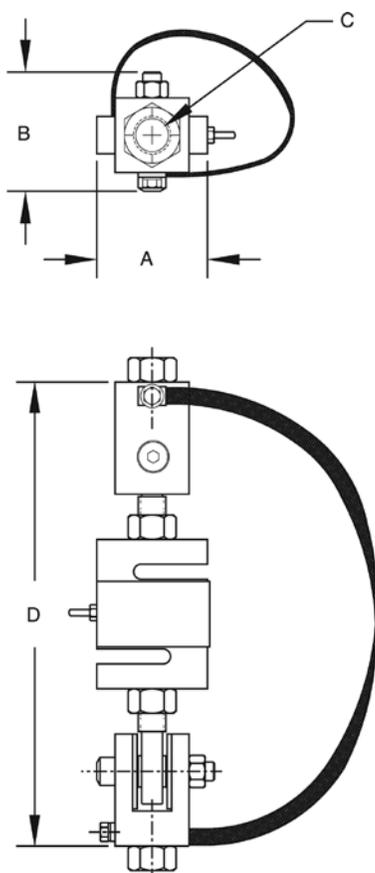

## RL50210 TA

50-500 lb Capacity Mini Tank Weighing Module

### Standard Features

- Zinc plated, mild steel modules
- Lower weighing ranges from 50-500 lb (22.7-226.8 kg) per module
- Environmentally protected load cells
- Neoprene isolation/compression mounts allow for minor misalignment, thermal expansion and shock absorption
- Overload stop for 500 lb (226.8 kg) modules provides durability

### Applications

- Small tanks and hoppers
- Conveyor/In-motion weighing
- Small platform scales where minor shock loading may be a problem

### Optional Features

- Stainless steel modules available in 50, 100, 150, 250 and 500 lb (22.7, 45.4, 68.0, 113.4, 226.8 kg) capacity with RL50210SS, RL50210SS and RL39123 stainless steel load cells or Vishay Sensortronics 65023 SS load cells
- 65059 kits available with Vishay Sensortronics 60040 load cells, capacities: 50-250 lb (22.7-113.4 kg) or 65023 load cells, capacity: 500 lb (226.8 kg)

### Complete Kit Includes

- 1 JB4SS NEMA 4X stainless steel signal trim junction box
- 3 or 4 RL50210 cantilever beam load cells (50-250 lb models)
- 3 or 4 RL30000 single-ended beam load cells (500 lb models)
- 3 or 4 neoprene isolation/compression mounts
- 25 ft of our Hostile Environment EL147HE SURVIVOR® load cell cable

### Load Cell Certifications



Rice Lake model only, not stainless steel models



Available in configurations with three or four mounting assemblies.

Picture is a representation of actual product

The RL50210 TA Weigh Module Kit provides a cost-effective alternative for your customers' low-range weighing needs. A variety of features makes this kit easy to install and an exceptional choice for various indoor weighing applications where checking requirements are low. Environmentally protected load cells, neoprene isolation/compression mounts and other Rice Lake Weighing Systems components are the keys to this module's outstanding performance.

Module with RL50210 or RL50210SS cantilever beam load cell; capacities (per module): 50 lb (22.7 kg), 100 lb (45.4 kg), 150 lb (68.0 kg) and 250 lb (113.4 kg). 500 lb model features RL30000 single-ended beam load cell



# RL50210 TA

50-500 lb Capacity Mini Tank Weighing Module

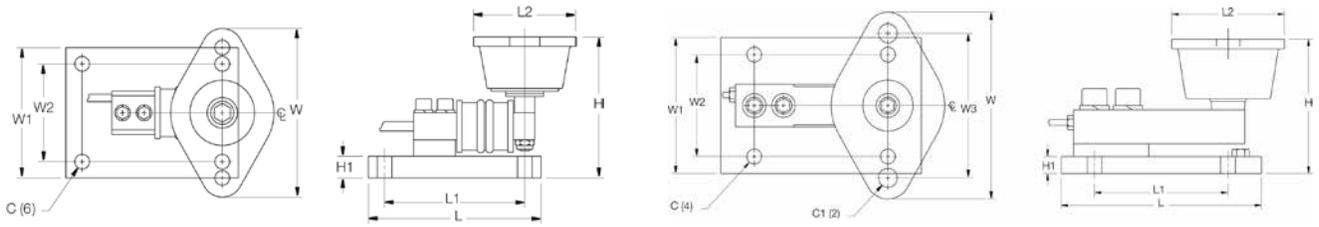

50-250 lb (22.7-113.4 kg)

500 lb (226.8 kg)

## Dimensions

RATED CAPACITY	C	C1	H	H1	L	L1	L2	W	W1	W2	W3
<b>lb/inches</b>											
50-250	.34	—	3.13	.50	4.00	3.25	2.38	3.88	3.00	2.25	—
500	.44	.56	3.88	.50	6.00	4.00	3.38	5.50	4.00	3.00	4.13
<b>kg/mm</b>											
22.7-113.4	8.6	—	79.5	12.7	101.6	82.6	60.5	98.6	76.2	57.2	—
226.8	11.2	14.2	98.6	12.7	152.4	101.6	85.9	139.7	101.6	76.2	104.9

## Order Information

*LOAD RATING (PER MODULE)	PART #	PRICE
<b>Mild Steel Single Module (Includes Load Cell)</b>		
50 lb (22.7 kg)	17844	\$395.00
100 lb (45.4 kg)	17845	395.00
150 lb (68.0 kg)	17846	395.00
250 lb (113.4 kg)	17847	395.00
500 lb (226.8 kg)	17848	525.00
<b>Mild Steel 3-Module Kit</b>		
50 lb (22.7 kg)	18051	1,370.00
100 lb (45.4 kg)	18052	1,370.00
150 lb (68.0 kg)	18053	1,370.00
250 lb (113.4 kg)	18054	1,370.00
500 lb (226.8 kg)	18055	1,775.00
<b>Mild Steel 4-Module Kit</b>		
50 lb (22.7 kg)	18057	1,760.00
100 lb (45.4 kg)	18058	1,760.00
150 lb (68.0 kg)	18059	1,760.00
250 lb (113.4 kg)	18060	1,760.00
500 lb (226.8 kg)	18061	2,250.00
<b>Stainless Steel Single Module (Includes Load Cell)</b>		
50 lb (22.7 kg)	63033	625.00
100 lb (45.4 kg)	63034	625.00
150 lb (68.0 kg)	63035	625.00
250 lb (113.4 kg)	63036	625.00
500 lb (226.8 kg)	17954	610.00
<b>Stainless Steel 3-Module Kit</b>		
500 lb (226.8 kg)	30394	2,020.00
<b>Stainless Steel 4-Module Kit</b>		
500 lb (226.8 kg)	30393	2,650.00

## VPG Scentroidrics 65059

### Order Information

*LOAD RATING (PER MODULE)	PART #	PRICE
<b>Mild Steel Single Module (Includes Load Cell)</b>		
50 lb (22.7 kg)	17825	\$395.00
100 lb (45.4 kg)	17826	395.00
150 lb (68.0 kg)	17827	395.00
250 lb (113.4 kg)	17828	395.00
500 lb (226.8 kg)	17829	525.00
<b>Mild Steel 3-Module Kit</b>		
50 lb (22.7 kg)	18063	1,370.00
100 lb (45.4 kg)	18064	1,370.00
150 lb (68.0 kg)	18065	1,370.00
250 lb (113.4 kg)	18066	1,370.00
500 lb (226.8 kg)	18067	1,775.00
<b>Mild Steel 4-Module Kit</b>		
50 lb (22.7 kg)	18069	1,760.00
100 lb (45.4 kg)	18070	1,760.00
150 lb (68.0 kg)	18071	1,760.00
250 lb (113.4 kg)	18072	1,760.00
500 lb (226.8 kg)	18073	2,250.00
<b>Stainless Steel Single Module (Includes Load Cell)</b>		
500 lb (226.8 kg)	17950	610.00
<b>Stainless Steel 3-Module Kit</b>		
500 lb (226.8 kg)	30392	2,020.00
<b>Stainless Steel 4-Module Kit</b>		
500 lb (226.8 kg)	30391	2,650.00

\* Load Rating is per module

# RL50210 TA

1000-2500lb Capacity Mini Tank Weighing Module



Available in configurations with three or four mounting assemblies.

Picture is a representation of actual product

The RL50210 TA Weigh Module Kit provides a cost-effective alternative for your customers' medium-range weighing needs. A variety of features makes this kit easy to install and an exceptional choice for various indoor weighing applications where checking requirements are low. Environmentally protected load cells, neoprene isolation/compression mounts and other Rice Lake Weighing Systems components are the keys to this module's performance.

Module with RL35023 single-ended shear beam load cell; capacities (per module): NTEP Certified 1000 lb (453.6 kg) load cell shown.



## Standard Features

- NTEP Certified load cells (alloy steel only), 1:5000d, Class III Multiple Cell
- Zinc plated, mild steel assemblies
- Medium weighing ranges from 1000-2500 lb (453.6-1134.0 kg) per module
- Environmentally protected load cells
- Neoprene isolation/compression mounts allow for minor misalignment, thermal expansion and shock absorption
- Overload stop provides durability
- RL50210 stainless steel mounts use RL35023S stainless steel load cells, capacities: 1000-2500 lb (453.6-1134.0 kg) NTEP cells
- 65059 stainless steel mounts use Vishay Sensortronics 65023S NTEP stainless steel load cells

## Applications

- Small tanks and hoppers
- Conveyor/In-motion weighing
- Small platform scales where minor shock loading may be a problem

## Complete Kit Includes

- 1 JB4SS NEMA 4X stainless steel signal trim junction box
- 3 or 4 RL35023 shear beam load cells
- 3 or 4 neoprene isolation/compression mounts
- 25 ft of our Hostile Environment EL147HE SURVIVOR® load cell cable

## Optional Features

- Welded stainless steel cells available in stainless steel mounts

## Load Cell Certifications



NOTE: Check with your local weights and measure officials for suitability in Legal for Trade applications.



# RL50210 TA

1000-2500 lb Capacity Mini Tank Weighing Module

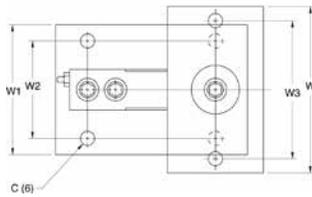

1000 lb (453.6 kg)

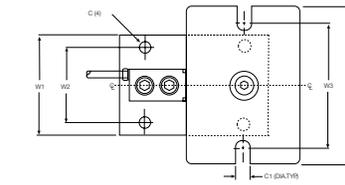
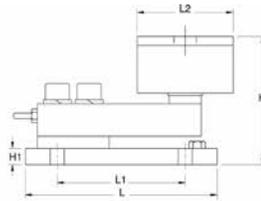

2000 lb-2500 lb (907.2 kg-1134.0 kg)

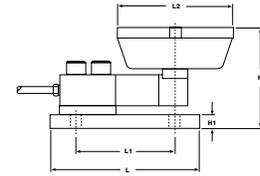

## Dimensions

RATED CAPACITY	C	C1	H	H1	L	L1	L2	W	W1	W2	W3
<b>lb/inches</b>											
1000	.44	—	4.00	.50	6.00	4.00	3.00	5.13	4.00	3.00	4.13
2000-2500	.44	.56	4.00	.50	6.00	4.00	4.62	6.25	4.00	3.00	5.00
<b>kg/mm</b>											
453.6	11.2	—	101.6	12.7	152.4	101.6	76.2	130.3	101.6	76.2	104.9
907.2-1134.0	11.2	14.2	101.6	12.7	152.4	101.6	117.3	158.8	101.6	76.2	127.0

## Order Information

*LOAD RATING (PER MODULE)	PART #	PRICE
<b>Mild Steel Single Module (Includes Load Cell)</b>		
1000 lb (453.6 kg)	17849	\$525.00
2000 lb (907.2 kg)	17948	525.00
2500 lb (1134.0 kg)	17949	525.00
<b>Mild Steel 3-Module Kit</b>		
1000 lb (453.6 kg)	18056	1,775.00
2000 lb (907.2 kg)	30398	1,775.00
2500 lb (1134.0 kg)	30396	1,775.00
<b>Mild Steel 4-Module Kit</b>		
1000 lb (453.6 kg)	18062	2,275.00
2000 lb (907.2 kg)	30397	2,275.00
2500 lb (1134.0 kg)	30395	2,275.00
<b>Stainless Steel Single Module (Includes Load Cell)</b>		
1000 lb (453.6 kg)	17955	610.00
2000 lb (907.2 kg)	17956	610.00
2500 lb (1134.0 kg)	17957	610.00
<b>Stainless Steel 3-Module Kit</b>		
1000 lb (453.6 kg)	30404	2,020.00
2000 lb (907.2 kg)	30402	2,020.00
2500 lb (1134.0 kg)	30400	2,020.00
<b>Stainless Steel 4-Module Kit</b>		
1000 lb (453.6 kg)	30403	2,650.00
2000 lb (907.2 kg)	30401	2,650.00
2500 lb (1134.0 kg)	30399	2,650.00

\* Load Rating is per module

## VPG Sensortronics 65059

### Order Information

*LOAD RATING (PER MODULE)	PART #	PRICE
<b>Mild Steel Single Module (Includes Load Cell)</b>		
1000 lb (453.6 kg)	17830	\$525.00
2000 lb (907.2 kg)	17946	525.00
2500 lb (1134.0 kg)	17947	525.00
<b>Mild Steel 3-Module Kit</b>		
1000 lb (453.6 kg)	18068	1,775.00
2000 lb (907.2 kg)	30413	1,775.00
2500 lb (1134.0 kg)	30412	1,775.00
<b>Mild Steel 4-Module Kit</b>		
1000 lb (453.6 kg)	18074	2,275.00
2000 lb (907.2 kg)	30414	2,275.00
2500 lb (1134.0 kg)	30411	2,275.00
<b>Stainless Steel Single Module (Includes Load Cell)</b>		
1000 lb (453.6 kg)	17951	610.00
2000 lb (907.2 kg)	17952	610.00
2500 lb (1134.0 kg)	17953	610.00
<b>Stainless Steel 3-Module Kit</b>		
1000 lb (453.6 kg)	30410	2,020.00
2000 lb (907.2 kg)	30408	2,020.00
2500 lb (1134.0 kg)	30406	2,020.00
<b>Stainless Steel 4-Module Kit</b>		
1000 lb (453.6 kg)	30409	2,650.00
2000 lb (907.2 kg)	30407	2,650.00
2500 lb (1134.0 kg)	30405	2,650.00

\* Load Rating is per module

# Paramounts® EP

Environmentally Protected Mild Steel, Light-to Medium-Capacity Tank Weighing Systems



Available in configurations with three or four mounting assemblies.  
Picture is a representation of actual product

The Paramounts EP system offers all the design advantages of the Paramounts system in applications where the extensive sealing of the SB4 load cell is not necessary. Paramounts EP provides a low-cost alternative for the superior mechanical loading system found in the standard Paramounts. Economy and performance are in one complete weighing system.

Free-Sliding Module with Flintec SB5 bending beam load cell.

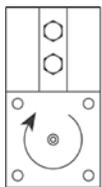

A: FIXED PIN

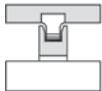

B: FREE SLIDING

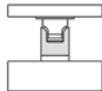

C: SIDE STOP

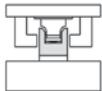

Fixed-Pin Mount

Free-Sliding Mount

Side-Stop Mount

## Standard Features

- Capacities (per module): 1125-22,500 lb (1 kN/102.1 kg-100 kN/10,205.9 kg)
- NTEP Certified load cells
- Unique design allows for thermal expansion/contraction
- Jacking screw allows empty vessel to be lifted clear of load cell for maintenance
- Unique blind load hole eliminates unwanted side and eccentric loads
- Vessel is free to slide laterally on PTFE-coated surfaces
- Load cell outputs are matched to  $\pm 0.07\%$  allowing replacement without further calibration

## Applications

- Light to medium-capacity tanks and hoppers
- High-vibration mixers and blenders
- Process measurement and control

## Complete Kit Includes

- 1 JB4SS NEMA 4X stainless steel signal trim junction box
- 1 fixed-pin module, 1 side-stop module, and 1 or 2 free-sliding assemblies. Each module is complete with a Flintec SB5 NTEP Certified 1:5000d, Class III, stainless steel environmentally-protected load cell
- 25 ft of our Hostile Environment EL147HE SURVIVOR® load cell cable

## Load Cell Certifications



Available

NOTE: Check with your local weights and measure officials for suitability in Legal for Trade applications.

# Paramounts® EP

Environmentally Protected Mild Steel, Light-to-Medium-Capacity Tank Weighing Systems

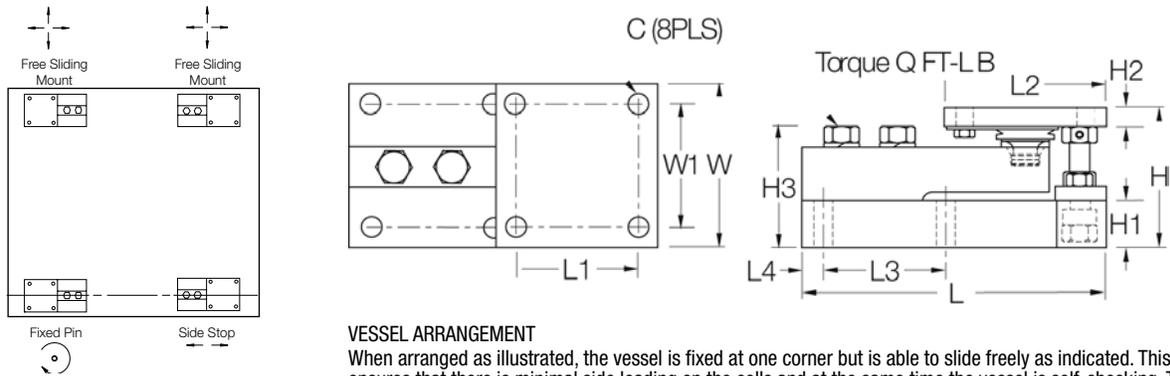

### VESSEL ARRANGEMENT

When arranged as illustrated, the vessel is fixed at one corner but is able to slide freely as indicated. This ensures that there is minimal side loading on the cells and at the same time the vessel is self-checking. The unique, patented blind load hole technology used in these mounts introduces the load at the neutral axis of the load cell which helps minimize the effects of side loads.

## Dimensions

RATED CAPACITY	C	H	H1	*H2	**H2	H3	L	L1	L2	L3	L4	W	W1	Q (FT-LB)	
<b>lb/inches</b>															
1125-4500	(5-23 kN†)	.437	3.58	1.25	.50	.75	3.06	7.51	3.00	4.00	3.00	.50	4.00	3.00	65
11,250	(50 kN†)	.562	4.66	1.50	.62	1.00	4.09	9.19	3.87	5.00	3.87	.56	5.00	3.87	295
22,500	(100 kN†)	.688	6.41	2.00	.75	1.25	5.73	11.46	4.75	6.00	4.75	.69	6.00	4.75	515
<b>kg/mm</b>															
510.8-2041		11.1	90.9	31.8	12.7	19.1	77.7	190.8	76.2	101.6	76.2	12.7	101.6	76.2	—
5107.5		14.3	118.4	38.1	15.7	25.4	103.9	233.4	98.3	127.0	98.3	14.2	127.0	98.3	—
10,215.0		17.5	162.8	50.8	19.1	31.8	145.5	291.1	120.7	152.4	120.7	17.5	152.4	120.7	—

## Order Information

LOAD RATING (PER MODULE)	PART #	PRICE
<b>NTEP 3-Module Kits</b>		
1125 lb (5 kN†/510.8 kg)	33683	\$2,175.00
2250 lb (10 kN†/1021.5 kg)	33682	2,175.00
4500 lb (20 kN†/2041.2 kg)	33681	2,175.00
11,250 lb (50 kN†/5107.5 kg)	33680	2,495.00
<b>NTEP 4-Module Kits</b>		
1125 lb (5 kN†/510.8 kg)	33678	2,900.00
2250 lb (10 kN†/1021.5 kg)	33677	2,900.00
4500 lb (20 kN†/2041.2 kg)	33676	2,900.00
11,250 lb (50 kN†/5107.5 kg)	33675	3,695.00
<b>Non-NTEP 3-Module Kit</b>		
22,500 lb (100 kN†/10,205.8 kg)	33679	3,975.00
<b>Non-NTEP 4-Module Kit</b>		
22,500 lb (100 kN†/10,215.0 kg)	33674	4,900.00

\* Side Stop and Free Sliding Units

\*\* Fixed Pin Units

† kN = Kilonewtons 1 kN = 224.8089 lb

# Paramounts® HS

Hermetically Sealed Load Cells Mild Steel, Light to-Medium Capacity Tank Weighing Systems



Available in configurations with three or four mounting assemblies.  
Picture is a representation of actual product

The Paramounts tank weighing system consists of one fixed-pin mount which allows only the top plate to rotate, one side-stop mount which allows the top plate to slide along the cell only, and one or more free-sliding mount(s) which allow the top plate to slide freely in all directions. This system provides self checking in applications of extreme temperature fluctuations and vibration while maintaining unparalleled system accuracy.

## Standard Features

- Capacities (per module): 520-22,500 lb (2.3 kN/102.1 kg-100 kN/10,205.9 kg)
- Unique design allows for thermal expansion/contraction
- Jacking screw allows empty vessel to be lifted clear of load cell for maintenance
- Unique blind load hole eliminates unwanted side and eccentric loads
- Vessel is free to slide laterally on PTFE-coated surfaces
- Load cell outputs are matched to  $\pm 0.07\%$ , allowing replacement without further calibration

## Applications

- Light to medium-capacity tanks and hoppers
- High-vibration mixers and blenders
- Process measurement and control

## Complete Kit Includes

- 1 JB4SS NEMA 4X stainless steel signal trim junction box
- 1 fixed-pin module, 1 side-stop module, and 1 or 2 free-sliding assemblies. Each module is complete with a FLINTEC SB4 or SB10 (520 lb) stainless steel hermetically sealed load cell
- 25 ft of our Hostile Environment EL147HE SURVIVOR® load cell cable

## Optional Features

- NTEP Certified load cells available: capacities 1125-11,250 lb

## Load Cell Certifications



NOTE: Check with your local weights and measure officials for suitability in Legal for Trade applications.

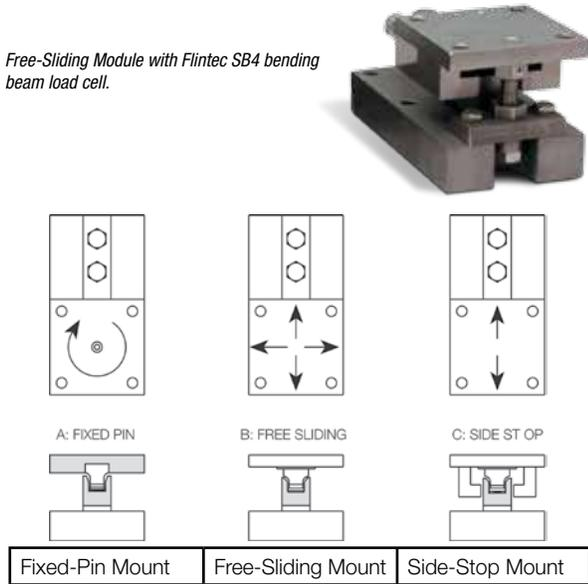

# Paramounts® HS

Hermetically Sealed Load Cells Mild Steel, Light-to-Medium-Capacity Tank Weighing Systems

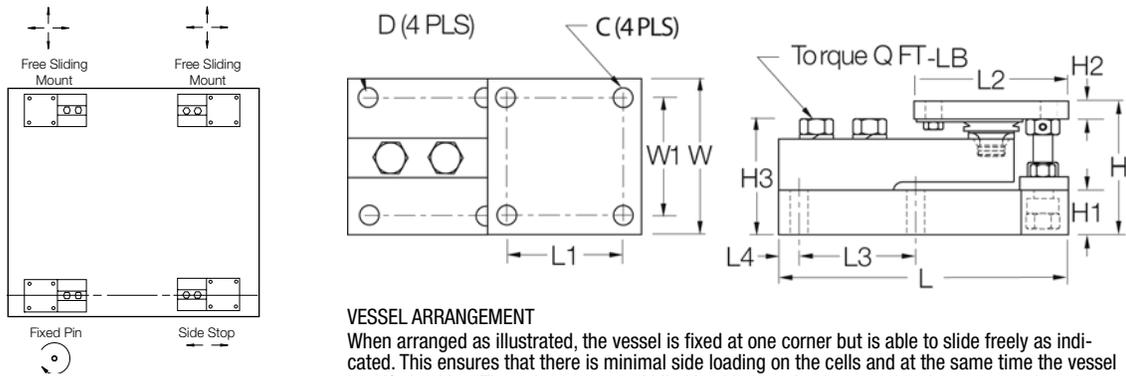

## VESSEL ARRANGEMENT

When arranged as illustrated, the vessel is fixed at one corner but is able to slide freely as indicated. This ensures that there is minimal side loading on the cells and at the same time the vessel is self-checking. The unique, patented blind load hole technology used in these mounts introduces the load at the neutral axis of the load cell which helps minimize the effects of side loads.

## Dimensions

RATED CAPACITY	C	D	H	H1	*H2	**H2	H3	L	L1	L2	L3	L4	W	W1	Q (FT-LB)	
<b>lb/inches</b>																
520 (2.3 kN†)	.375	.437	3.49	1.00	.50	.75	2.98	7.51	3.00	4.00	3.00	.50	4.00	3.00	65	
1125-5200 (5-23 kN†)	.437	.437	3.58	1.25	.50	.75	3.06	7.51	3.00	4.00	3.00	.50	4.00	3.00	65	
11,250 (50 kN†)	.562	.562	4.66	1.50	.62	1.00	4.09	9.19	3.87	5.00	3.87	.56	5.00	3.87	295	
22,500 (100 kN†)	.688	.688	6.41	2.00	.75	1.25	5.73	11.46	4.75	6.00	4.75	.69	6.00	4.75	515	
<b>kg/mm</b>																
236.1	9.5	11.1	88.6	25.4	12.7	19.1	75.7	190.8	76.2	101.6	76.2	12.7	101.6	76.2	—	
510.8-2360	11.1	11.1	90.9	31.8	12.7	19.1	77.7	190.8	76.2	101.6	76.2	12.7	101.6	76.2	—	
5107.5	14.3	14.3	118.4	38.1	15.7	25.4	103.9	233.4	98.3	127.0	98.3	14.2	127.0	98.3	—	
10,215.0	17.5	17.5	162.8	50.8	19.1	31.8	145.5	291.1	120.7	152.4	120.7	17.5	152.4	120.7	—	

## Order Information

LOAD RATING (PER MODULE)	PART #	PRICE
<b>NTEP 3-Module Kit</b>		
1125 lb (5 kN†/510.8 kg)	29871	\$2,695.00
2250 lb (10 kN†/1021.5 kg)	29872	2,695.00
5200 lb (23 kN†/2360.8 kg)	29873	2,695.00
11,250 lb (50 kN†/5107.5 kg)	29874	3,295.00
<b>NTEP 4-Module Kit</b>		
1125 lb (5 kN†/510.8 kg)	29875	3,525.00
2250 lb (10 kN†/1021.5 kg)	29876	3,525.00
5200 lb (23 kN†/2360.8 kg)	29877	3,525.00
11,250 lb (50 kN†/5107.5 kg)	29878	3,895.00

\* Side Stop and Free Sliding Units

\*\* Fixed Pin units

† kN = Kilonewtons 1 kN = 224.8089 lb

## Order Information

LOAD RATING (PER MODULE)	PART #	PRICE
<b>Non-NTEP 3-Module Kit</b>		
520 lb (2.3 kN†/236.1 kg)	38205	\$3,595.00
1125 lb (5 kN†/510.8 kg)	17977	2,695.00
2250 lb (10 kN†/1021.5 kg)	17978	2,695.00
5200 lb (23 kN†/2360.8 kg)	17979	2,695.00
11,250 lb (50 kN†/5107.5 kg)	17980	3,295.00
22,500 lb (100 kN†/10,215.0 kg)	17981	4,095.00
<b>Non-NTEP 4-Module Kit</b>		
520 lb (2.3 kN†/236.1 kg)	38206	4,795.00
1125 lb (5 kN†/510.8 kg)	17984	3,525.00
2250 lb (10 kN†/1021.5 kg)	17985	3,525.00
5200 lb (23 kN†/2360.8 kg)	17986	3,525.00
11,250 lb (50 kN†/5107.5 kg)	17987	4,095.00
22,500 lb (100 kN†/10,215.0 kg)	17988	4,995.00
**Conduit Adapter	17703	35.00

\*\*1/2-14 NPT

## RLBTM Mild/Stainless

Steel Weigh Modules

### Standard Features

- Capacities (per module): 500-5,000 lb SE mild steel/1,000-4,000 lb stainless steel
- Zinc plated mild steel construction or stainless steel
- Self-checking, multi-directional movement
- Design incorporates a ball and cup for self centering
- The RLBTM will accommodate a standard shear beam 500 lb-5,000 lb SE load cell that has a threaded load hole. RL30000, RL39123, RL35023, RL35082, RL35083.

### Applications

- Light to medium-capacity tanks and hoppers
- Conveyors



*Does not include load cell.*

*Picture is a representation of actual product*

The RLBTM mount was specifically created to take advantage of the improved load introduction accuracy of the ball and cup design. This multi-purpose mount is ideal for both indoor and outdoor applications, and can be used with a variety of single-ended beam load cells. Available in both mild and stainless steel. This product offers superior accuracy at an affordable price. These assemblies are also quick and easy to install, making the RLBTM the perfect choice for your low-capacity, multi-purpose weighing needs.

# RLBTM Mild/Stainless

Steel Weigh Modules

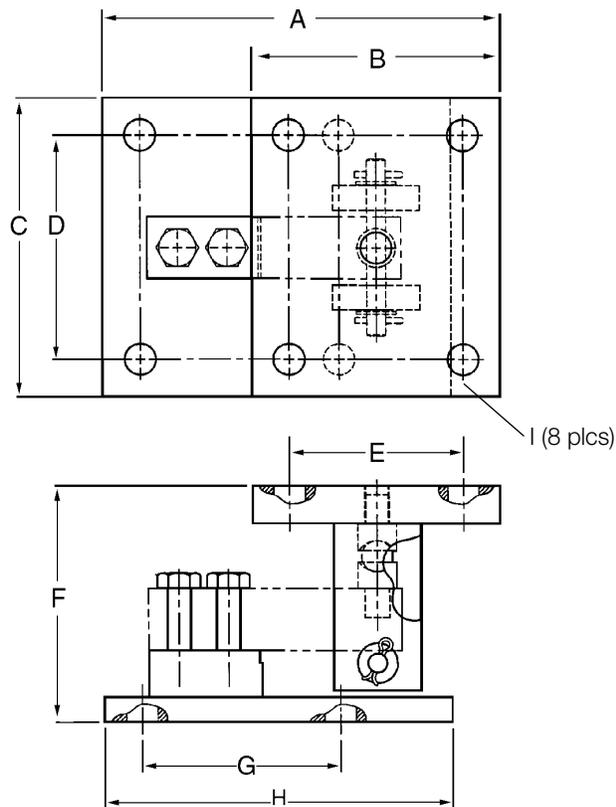

## Dimensions

RATED CAPACITY	A	B	C	D	E	F	G	H	I
<b>lb/inches</b>									
250-5000 SE	8.00	5.00	6.00	4.50	3.50	4.75	4.00	7.00	.63
<b>kg/mm</b>									
113.4/2268.0	203.2	127	152.4	114.3	88.9	120.6	101.6	177.8	16.0

## Mild Steel Order Information

*LOAD RATING (PER MODULE)	PART #	PRICE
<b>Single Module (Does NOT Include Load Cell)</b>		
500 lb-5,000 lb SE (113.4-2268.0 kg)	53059	\$325.00

SE refers to small envelope

\* Load Rating is per module

## Stainless Steel Order Information

*LOAD RATING (PER MODULE)	PART #	PRICE
<b>Single Module (Does NOT Include Load Cell)</b>		
1,000-4,000 lb (453.6-1814.4 kg)	53066	\$515.00

## RL1800 Series

Mild Steel/Stainless Steel Weigh Modules

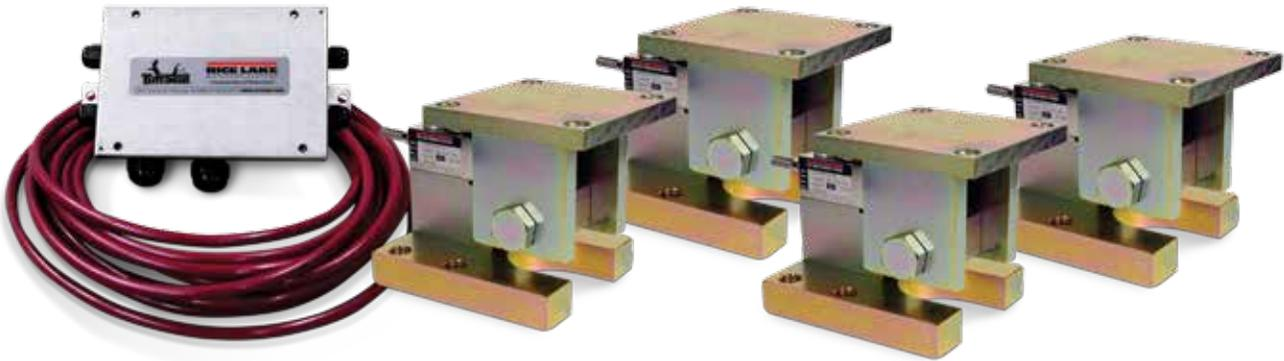

Available in configurations with three or four mounting assemblies.

Picture is a representation of actual product

The RL1800 Series Mounting Assembly Kit utilizes several Rice Lake Weighing Systems components to provide an unmatched level of performance in tank and hopper weighing applications. The RL1800 Series kit is ideally suited for indoor and outdoor process control operations with medium-range capacities. Each module combines multi-directional movement and self-checking capabilities. The RL35023 and RL35023S load cells used are NTEP certified in capacities of 1000lb to 10,000lb.

Module with RL35023 single-ended beam load cell.



### Standard Features

- Capacities (per module): 250-10,000 lb (113.4-4535.9 kg)
- NTEP Certified cells in 1000-10,000 lb (453.6-4535.9 kg) capacities, except 3000 lb (1360.9 kg)
- Zinc plated mild steel/stainless steel construction
- Center-pivoted, tension loading design
- Self-checking, multi-directional movement
- Load is suspended on high-strength bolt instead of wire rope
- Design incorporates spherical washers for self centering
- Stainless steel kit includes RL35023S NTEP Certified load cell

### Applications

- Conveyors
- Medium-capacity tanks and hoppers

### Complete Kit Includes

- 1 JB4SS NEMA 4X stainless steel signal trim junction box
- 3 or 4 RL1800 mild or stainless steel compression mounts
- 3 or 4 RL35023 single-ended beam load cells, RL35023S used in stainless kits
- 25 ft of our Hostile Environment EL147HE SURVIVOR® load cell cable

### Load Cell Certifications



Except 520 lb



NOTE: Check with your local weights and measure officials for suitability in Legal for Trade applications.



# RL1800 Series

Mild Steel/Stainless Steel Weigh Modules

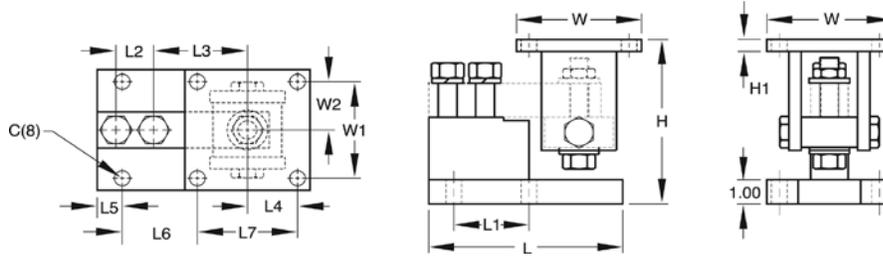

## Dimensions

RATED CAPACITY	C	H MIN/ MAX	H1	L	L1	L2	L3	L4	L5	L6	L7	W	W1	W2
<b>Mild Steel Construction</b>														
<b>lb/inches</b>														
250-5000 SE	.62	5.25/5.56	.50	6.00	2.00	1.00	3.00	2.00	.68	1.94	4.00	5.00	4.00	2.00
5000 LE-10,000	.62	6.12/6.62	.50	7.75	3.00	1.50	3.75	2.00	1.03	2.97	4.00	5.00	4.00	2.00
<b>kg/mm</b>														
113.4-2268.0	15.8	133.4/141.2	12.7	152.4	50.8	25.4	76.2	50.8	17.3	49.3	101.6	127.0	101.6	50.8
2268.0-4535.9	15.8	155.4/168.1	12.7	196.9	76.2	38.1	95.3	50.8	26.2	75.4	101.6	127.0	101.6	50.8
<b>Stainless Steel Construction</b>														
<b>lb/inches</b>														
1000-4000	.62	5.25/5.56	.50	6.00	2.00	1.00	3.00	2.00	.68	1.94	4.00	5.00	4.00	2.00
5000-10,000	.62	6.12/6.62	.50	7.75	3.00	1.50	3.75	2.00	1.03	2.97	4.00	5.00	4.00	2.00
<b>kg/mm</b>														
453.6-1814.4	15.8	133.4/141.2	12.7	152.4	50.8	25.4	76.2	50.8	17.3	49.3	101.6	127.0	101.6	50.8
2268.0-4535.9	15.8	155.4/168.1	12.7	196.9	76.2	38.1	95.3	50.8	26.2	75.4	101.6	127.0	101.6	50.8

## Mild Steel Order Information

*LOAD RATING (PER MODULE)	PART #	PRICE
<b>Single Module (Does NOT Include Load Cell)</b>		
250-5000 lb SE (113.4-2268.0 kg)	17817	\$325.00
5000 LE-10,000 lb (2268.0-4535.9 kg)	17819	350.00
<b>3-Module Kit</b>		
**250 lb (113.4 kg)	18075	1,995.00
**500 lb (226.8 kg)	18076	1,995.00
1000 lb (453.6 kg)	18077	1,995.00
2000 lb (907.2 kg)	18078	1,995.00
2500 lb (1134.0 kg)	18079	1,995.00
3000 lb (1360.8 kg)	18080	1,995.00
4000 lb (1814.4 kg)	18081	1,995.00
5000 lb SE (2268.0 kg)	18082	1,995.00
5000 lb LE (2268.0 kg)	18083	2,295.00
10,000 lb (4535.9 kg)	18084	2,295.00
<b>4-Module Kit</b>		
**250 lb (113.4 kg)	18085	2,595.00
**500 lb (226.8 kg)	18086	2,595.00
1000 lb (453.6 kg)	18087	2,595.00
2000 lb (907.2 kg)	18088	2,595.00
2500 lb (1134.0 kg)	18089	2,595.00
3000 lb (1360.8 kg)	18090	2,595.00
4000 lb (1814.4 kg)	18091	2,595.00
5000 lb SE (2268.0 kg)	18092	2,595.00
5000 lb LE (2268.0 kg)	18093	2,995.00
10,000 lb (4535.9 kg)	18094	2,995.00

SE refers to small envelope  
LE refers to large envelope

## Stainless Steel Order Information

*LOAD RATING (PER MODULE)	PART #	PRICE
<b>Single Module (Does NOT Include Load Cell)</b>		
250-4000 lb (113.4-1814.4 kg)	17818	\$525.00
5000-10,000 lb (2268.0-4535.9 kg)	17820	550.00
<b>3-Module Kit</b>		
1000 lb (453.6 kg)	18095	2,695.00
2000 lb (907.2 kg)	18096	2,695.00
2500 lb (1134.0 kg)	18097	2,695.00
4000 lb (1814.4 kg)	18099	2,695.00
5000 lb LE (2268.0 kg)	18100	2,925.00
10,000 lb (4535.9 kg)	18101	2,925.00
<b>4-Module Kit</b>		
1000 lb (453.6 kg)	18102	3,595.00
2000 lb (907.2 kg)	18103	3,595.00
2500 lb (1134.0 kg)	18104	3,595.00
4000 lb (1814.4 kg)	18106	3,595.00
5000 lb LE (2268.0 kg)	18107	3,910.00
10,000 lb (4535.9 kg)	18108	3,910.00
<b>Dummy Cell</b>		
Dummy load cell 1-5 k SE	22980	45.00

\* Load Rating is per module

\*\* Use RL30000 load cells

# RL1900 Series

Stainless Steel Weigh Modules

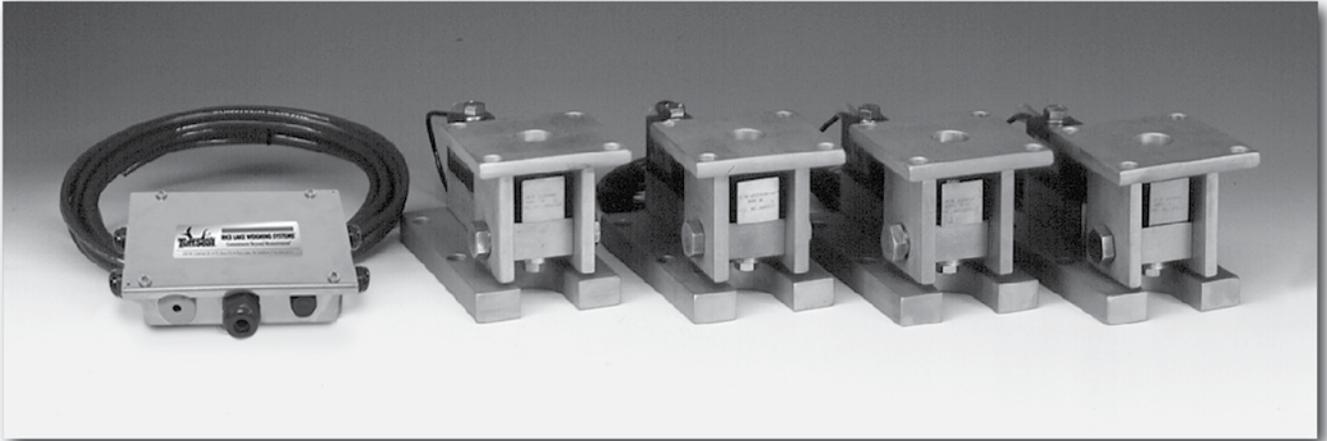

Available in configurations with three or four mounting assemblies.

Picture is a representation of actual product

The RL1900 Series Weigh Module Kit utilizes several Rice Lake Weighing Systems components to provide an unmatched level of performance in tank and hopper weighing applications. The RL1900 kit is ideally suited for tank, hopper and bin weighing operations with medium-range capacities. Each module combines multi-directional movement and self-checking capabilities. The welded seal stainless steel RLSSB load cell withstands washdown and corrosive environments that may present problems to other cells.

Module with welded-seal RLSSB single-ended beam load cell.



## Standard Features

- NTEP Certified load cells, 1:5000d, Class III Single Cell
- Capacities (per module): 1000-10,000 lb (453.6-4535.9 kg)
- 304 stainless steel construction
- Center-pivoted, tension loading design
- Welded-seal stainless steel load cells
- Self-checking, multi-directional movement
- Easy load cell replacement
- Load is suspended on high-strength bolt instead of wire rope
- Design incorporates spherical washers

## Applications

- Medium-capacity tanks, bins and hoppers
- Washdown or corrosive applications

## Optional Features

- Also compatible with HBM SB3 load cells
- Also compatible with RTI SSB load cells

## Complete Kit Includes

- 1 JB4SS NEMA 4X stainless steel signal trim junction box
- 3 or 4 RL1900 stainless steel compression mounts
- 3 or 4 RLSSB welded stainless steel single-ended beam load cells
- 25 ft of our Hostile Environment EL147HE SURVIVOR® load cell cable

## Load Cell Certifications



Except 520 lb



Rice Lake  
load cells only

*NOTE: Check with your local weights and measure officials for suitability in Legal for Trade applications.*

# RL1900 Series

Stainless Steel Weigh Modules

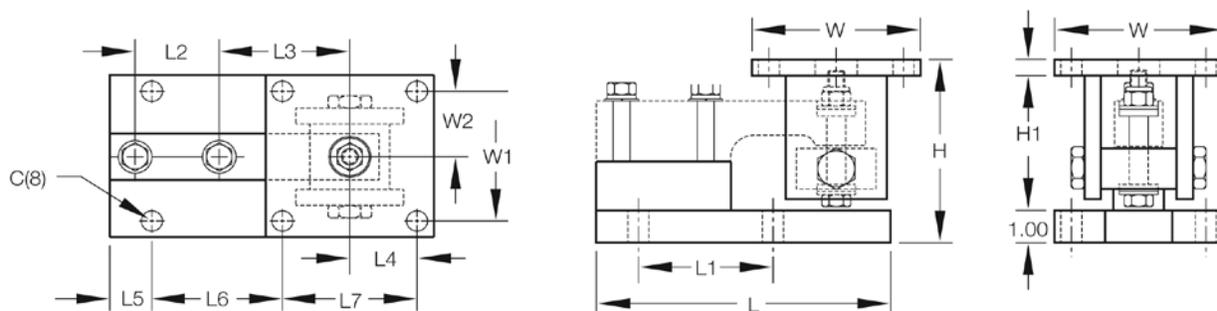

## Dimensions

RATED CAPACITY	C	H MIN/MAX	H1	L	L1	L2	L3	L4	L5	L6	L7	W	W1	W2
<b>lb/inches</b>														
1000-5000	.62	5.38/5.62	.50	8.75	4.00	2.50	3.88	2.00	1.12	4.00	4.00	5.00	4.00	2.00
10,000	.81	6.88/7.50	1.00	9.75	5.00	2.63	4.88	2.25	1.00	5.00	4.50	6.00	4.50	2.25
<b>kg/mm</b>														
453.6-2268.0	15.8	136.7/142.9	12.7	222.3	101.6	63.5	98.6	50.8	28.4	101.6	101.6	127.0	101.6	50.8
4535.9	20.6	174.8/190.5	25.4	247.7	127.0	66.8	124.0	57.2	25.4	127.0	114.3	152.4	114.3	57.2

## Order Information

*LOAD RATING (PER MODULE)	PART #	PRICE
<b>Single Module (Does NOT include Load Cell)</b>		
1000-5000 lb (453.6-2268.0 kg)	17841	\$575.00
10,000 lb (4535.9 kg)	17843	625.00
<b>3-Module Kit</b>		
1000 lb (453.6 kg)	18109	3,670.00
2000 lb (907.2 kg)	18110	3,670.00
5000 lb (2268.0 kg)	18111	3,670.00
10,000 lb (4535.9 kg)	18112	4,085.00
<b>4-Module Kit</b>		
1000 lb (453.6 kg)	18113	4,895.00
2000 lb (907.2 kg)	18114	4,895.00
5000 lb (2268.0 kg)	18115	4,895.00
10,000 lb (4535.9 kg)	18116	5,415.00

\* Load Rating is per module

## RLTM

### Stainless Steel Tank Weigh Module



Picture is a representation of actual product

The RLTM weigh module assembly features a stainless steel, welded sealed RL30745 load cell and a fully stainless mount including all associated hardware. Using a rocker pin-loading concept, this design provides accurate weighing in most conditions. Standard features include both overload and overlift protection, making it ideal for most outdoor low-capacity tank and vessel weighing applications. Each Rice Lake RLTM module is provided standard with one load cell with 30 ft of cable and one mount.

### Load Cell Specifications:

**Full Scale Output:**

2.0 ± 0.2 mV/V

**Bridge Resistance:**

350 ohms

**Material/Finish:**

Stainless steel

**Temperature:**

Compensated range  
15°F to 104°F/-9°C to 40°C

**Safe Overload:**

150% Full scale

**Safe Sideload:**

100% Full scale

**Rated Excitation:**

15V DC

**Combined Error:**

0.03% Full scale

**Insulation Resistance:**

5000 megohms

**Seal Type:**

Welded seal, IP67

**Cable Length:**

30 ft/9.1 m (500-10 k)

**Cable Color Code:**

Green ..... + Excitation  
Black ..... - Excitation  
White ..... + Signal  
Red ..... - Signal

**Warranty:**

Two-year limited warranty

### Standard Features

- Capacities: 500-10,000 lb (226.8-4536.0 kg)
- Stainless steel
- Overload and overlift protection
- Rocker pin loading
- Welded sealed load cells
- Integral lateral stops
- 30 ft cable on load cells

### Applications

- Lower capacity tank and vessel weighing
- Process control and batching

### Complete Kit Includes

- 1 JB4SS NEMA 4X stainless steel signal trim junction box
- 3 or 4 Rice Lake RLTM stainless steel mounting assemblies
- 25 ft of our Hostile Environment EL147HE SURVIVOR® load cell cable

### Load Cell Certifications



# RLTM

## Stainless Steel Tank Weigh Module

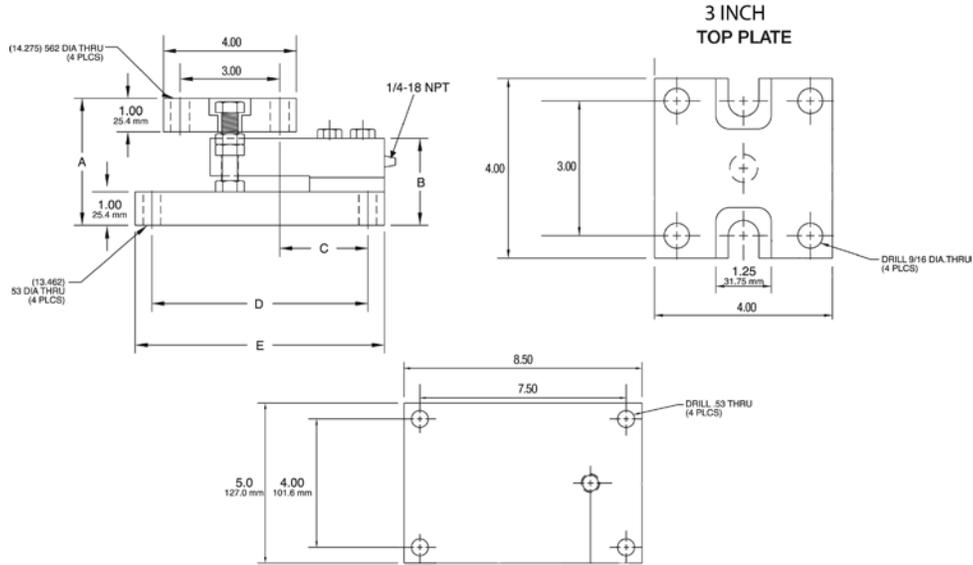

### Dimensions

RATED CAPACITY	A	B	C	D	E
<b>lb/inches</b>					
500-2500	3.77	2.59	2.62	6.50	7.50
5000	3.99	2.83	2.62	6.50	7.50
10,000	4.27	3.08	3.88	7.50	8.50
<b>kg/mm</b>					
226.8-1134	95.7	65.7	66.5	165.1	190.5
2268	101.3	71.8	66.5	165.1	190.5
4536	108.4	78.2	98.5	190.5	215.9

### Order Information

LOAD RATING (PER MODULE)	PART #	PRICE
500 lb (226.8 kg)	159288	\$895.00
1250 lb (567.0 kg)	159289	895.00
2500 lb (1134.0 kg)	159290	895.00
5000 lb (2268.0 kg)	159291	1,095.00
10,000 lb (4536.0 kg)	159292	1,095.00
<b>3-Module Kit</b>		
500 lb (226.8 kg)	162942	2,795.00
1250 lb (567.0 kg)	162944	2,795.00
2500 lb (1134.0 kg)	162945	2,795.00
5000 lb (2268.0 kg)	162946	3,495.00
10,000 lb (4536.0 kg)	162947	3,495.00

### Order Information

LOAD RATING	PART #	PRICE
<b>4-Module Kit</b>		
500 lb (226.8 kg)	162948	\$3,695.00
1250 lb (567.0 kg)	162949	3,695.00
2500 lb (1134.0 kg)	162950	3,695.00
5000 lb (2268.0 kg)	162951	4,495.00
10,000 lb (4536.0 kg)	162953	4,495.00

## RL9000TWM Series

Tank, Hopper and Vessel Weighing Assembly



*Picture is a representation of actual product*

The RL9000TWM Series stainless steel weigh module is ideal for use in tank, hopper, vessel, and many other applications. The low-profile design offers an economical solution in a competitive marketplace. This rugged, high-precision mount is designed for easy installation and does not require check rods or other stabilizing hardware. The stainless steel construction and welded seal offer additional protection in washdown areas.

### Load Cell Specifications

**Full Scale Output:**

3 mV/V +/- .1%

**Bridge Resistance:**

350 ohms

**Material/Finish:**

Stainless steel\*

**Safe Overload:**

150% F.S.

**Rated Excitation:**

10V DC

**Operating Temperature:**

0° to 150° F

**Insulation Resistance:**

5000 megohms

**Seal Type:**

Welded seal IP 67

**Cable Length:**

25 ft

**Cable Color Code:**

Green .....+ Excitation

Black.....- Excitation

White .....+ Signal

Red .....- Signal

**Warranty:**

Two-year limited

### Standard Features

- Capacities: 1000-450,000 lb
- Very low profile design
- 3 mV/V output
- Self-centering
- Self-checking assembly
- Offers 100% sideload, 100% uplift and 150% safe load and 300% ultimate overload protection
- Stainless steel construction
- Welded seal
- Weighs accurately with as much as a 3° non-parallel load
- Integral 25 ft cable

### Applications

- Tank, hopper, or vessel weighing

### Optional Features

- Stainless steel top plates
- \*150K-450 k have mild steel painted base plate

### Complete Kit Includes

- 1 JB4SS NEMA 4X stainless steel signal trim junction box
- 3 or 4 stainless steel mounting assemblies
- 25 ft of our Hostile Environment EL147HE SURVIVOR® load cell cable

### Load Cell Certifications



*Assembly with integral RL9000TWM compression disk load cell.*



# RL9000TWM Series

Tank, Hopper and Vessel Weighing Assembly

## Order Information

LOAD RATING (PER MODULE)	PART #	PRICE
<b>Single Module</b>		
1000 lb	84353	\$610.00
2500 lb	84354	610.00
5000 lb	84355	610.00
10,000 lb	84356	610.00
15,000 lb	84357	610.00
20,000 lb	84358	1,210.00
25,000 lb	84359	1,210.00
35,000 lb	84360	1,210.00
50,000 lb	84361	1,210.00
60,000 lb	84362	2,110.00
75,000 lb	84363	2,110.00
100,000 lb	84364	2,110.00
150,000 lb	84365	4,410.00
200,000 lb	84366	4,410.00
250,000 lb	84368	6,510.00
300,000 lb	84369	6,510.00
400,000 lb	84370	6,510.00
450,000 lb	84371	6,510.00
<b>3-Module Kit</b>		
1000 lb	98974	2,040.00
2500 lb	98980	2,040.00
5000 lb	98981	2,040.00
10,000 lb	98982	2,040.00
15,000 lb	98983	2,040.00
20,000 lb	98984	3,840.00
25,000 lb	98985	3,840.00
35,000 lb	98986	3,840.00
50,000 lb	98987	3,840.00
60,000 lb	98988	6,540.00
75,000 lb	98989	6,540.00
100,000 lb	98990	6,540.00
150,000 lb	98991	13,440.00
200,000 lb	98992	13,440.00
250,000 lb	98993	19,740.00
300,000 lb	98994	19,740.00
400,000 lb	98995	19,740.00
450,000 lb	98996	19,740.00

\*150 k-450 k have mild steel painted base plates

LOAD RATING (PER MODULE)	PART #	PRICE
<b>4-Module Kit</b>		
1000lb	98997	\$2,555.00
2500 lb	98998	2,555.00
5000 lb	98999	2,555.00
10,000 lb	99000	2,555.00
15,000 lb	99001	2,555.00
20,000 lb	99002	4,955.00
25,000 lb	99003	4,955.00
35,000 lb	99004	4,955.00
50,000 lb	99005	4,955.00
60,000 lb	99006	8,555.00
75,000 lb	99007	8,555.00
100,000 lb	99008	8,555.00
150,000 lb	99009	17,755.00
200,000 lb	99010	17,755.00
250,000 lb	99011	26,155.00
300,000 lb	99012	26,155.00
400,000 lb	99013	26,155.00
450,000 lb	99014	26,155.00
<b>Top Plates (Stainless Steel) with bolts</b>		
1 k-15 k	91207	150.00
20 k-50 k	91210	325.00
60 k-100 k	91211	695.00
150 k-200 k	91213	895.00
250 k-450 k	91215	1,695.00
<b>Top Plates (Mild Steel) with bolts</b>		
1 k-15 k	124758	75.00
20 k-50 k	125141	145.00
60 k-100 k	124759	195.00
150 k-200 k	124760	325.00
250 k-450 k	124761	425.00
<b>**Center Bolt Removal Tool</b>		
20-50 k	151637	32.00
60-100 k	151638	55.00
150-200 k	151639	99.00
250-450 k	161935	125.00
<b>Dummy Weigh Modules</b>		
1-10 k	158749	95.00
15 k	158750	125.00
20-50 k	158752	135.00
60-100 k	158753	150.00
150-200 k	158754	395.00
250-450 k	158755	425.00

\*150 k-450 k have mild steel painted base plates

\*\*1-15k use 5/16 allen wrench

# RL9000TWM Series

Tank, Hopper and Vessel Weighing Assembly

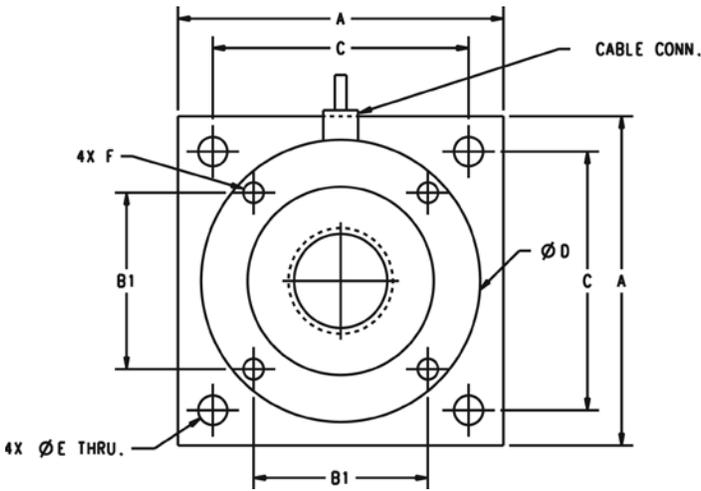

## Dimensions (inches)

RATED CAPACITY	A	B1	C	D	E	F	G	H	I	CONDUIT ADAPTER
1 k-10 k	4.00	2.00	3.25	3.50	0.40	3/8-16	1.35	0.375	0.75	N/A
15 k	4.00	2.00	3.25	3.50	0.40	3/8-16	1.60	0.625	0.75	N/A
20 k-50 k	7.00	3.75	5.50	6.00	0.63	1/2-13	2.48	0.75	1.30	1/2-14 NPT
60 k-100 k	8.00	4.25	6.50	7.00	0.81	3/4-16	2.50	1.00	1.30	1/2-14 NPT

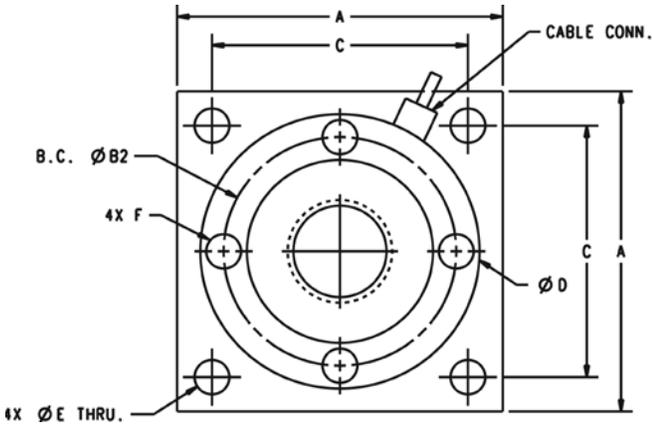

## Dimensions (inches)

RATED CAPACITY	A	B2	C	D	E	F	G	H	I	CONDUIT ADAPTER
150 k-200 k	10.0	7.825	8.00	9.00	1.10	1-14	4.75	2.00	1.70	1/2-14 NPT



# RL9000TWM Series

Tank, Hopper and Vessel Weighing Assembly

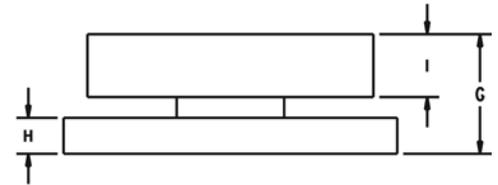
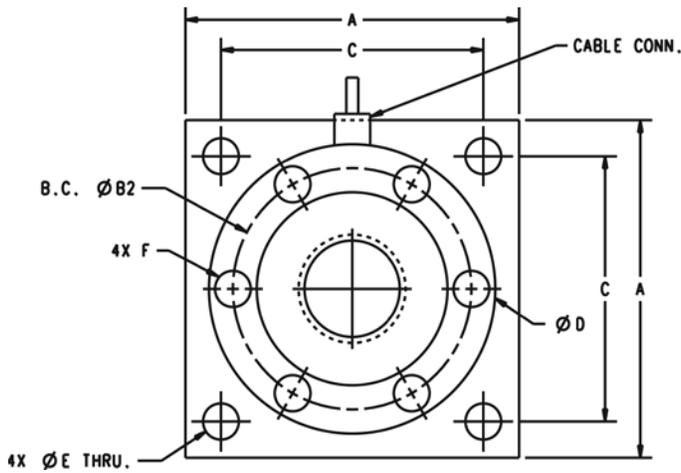

## Dimensions (inches)

RATED CAPACITY	A	B2	C	D	E	F	G	H	I	CONDUIT ADAPTER
250k-450k	11.00	7.75	9.00	9.00	1.30	7/8-14	6.42	3.00	2.25	1/2-14NPT

## Optional Top Plates

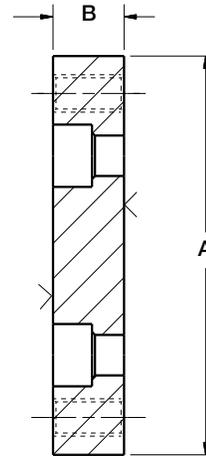
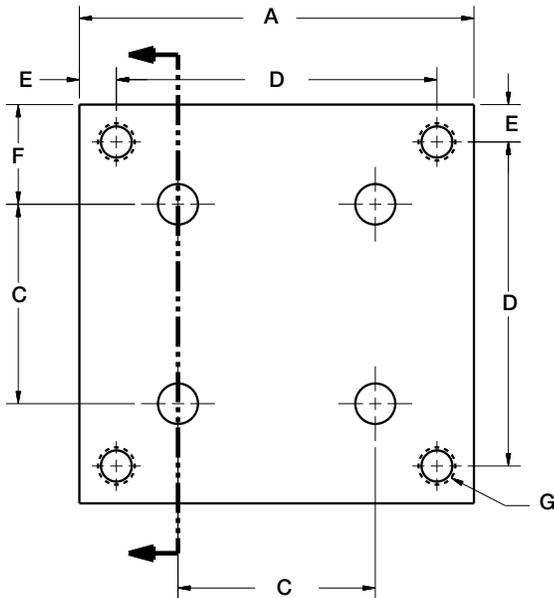

## Dimensions

RATED CAPACITY	A	B	C	D	E	F	G
<b>lb/inches</b>							
1k - 15k	4.00	0.72	2.00	3.25	0.38	1.00	3/8-16 NC
20k - 50k	7.00	0.97	3.75	5.50	0.75	1.62	5/8-11 NC
60k - 100k	8.00	1.46	4.25	6.50	0.75	1.88	3/4-16 NF
150k - 200k	10.00	1.94	5.53	8.00	1.00	2.25	1-14 UNS
250k - 450k	11.00	2.94	7.75 B.C.	9.00	1.00	1.00	1-1/4-12 NF

# RL9000TWM-HT

Tank, Hopper and Vessel Weighing Module

## Standard Features

- Capacities: 1000-50,000 lb
- Very low profile design
- 3 mV/V output
- Self-centering
- Self-checking assembly
- Offers 100% sideload, 100% uplift and 150% safe load and 300% ultimate overload protection
- Stainless steel construction
- Welded seal
- Weighs accurately with as much as a 3° on-parallel load
- Integral 25 ft FEP cable

## Optional Features

- Stainless steel top plates
- Higher capacities available upon request

## Applications

- Tank, hopper, or vessel weighing
- High temperature applications

## Load Cell Specifications

### Full Scale Output:

3 mV/V +/- .1%

### Bridge Resistance:

700 ohms

### Material/Finish:

Stainless steel\*

### Safe Overload:

150% F.S.

### Rated Excitation:

10V DC

### Operating Temperature:

0° to 400° F

### Insulation Resistance:

5000 megohms

### Seal Type:

Welded seal IP67

### Cable Length:

25 ft FEP Jacket

### Cable Color Code:

Green .....+ Excitation  
 Black.....- Excitation  
 White .....+ Signal  
 Red .....- Signal

### Warranty:

Two-year limited



Picture is a representation of actual product

The RL9000TWM-HT is the latest addition to the popular RL9000TWM Series weigh module. The RL9000TWM-HT is a high temperature version that is designed to operate in temperatures up to 400°F.

The integral 25 ft of FEP cable compliments the RL9000TWM-HT weigh module.

## Order Information

LOAD RATING (PER MODULE)	PART #	PRICE
<b>Single Module</b>		
1000 lb	117050	\$1,015.00
2500 lb	117051	1,015.00
5000 lb	117052	1,015.00
10,000 lb	117140	1,015.00
15,000 lb	117053	1,015.00
20,000 lb	117054	1,710.00
25,000 lb	117055	1,710.00
35,000 lb	117056	1,710.00
50,000 lb	117057	1,710.00
<b>Top Plates (Stainless Steel) with bolts</b>		
1 k-15 k	91207	150.00
20 k-50 k	91210	325.00
<b>Top Plates (Mild Steel) with bolts</b>		
1 k-15 k	124758	75.00
20 k-50 k	125141	145.00

# RL9000TWM-HT

Tank, Hopper and Vessel Weighing Module

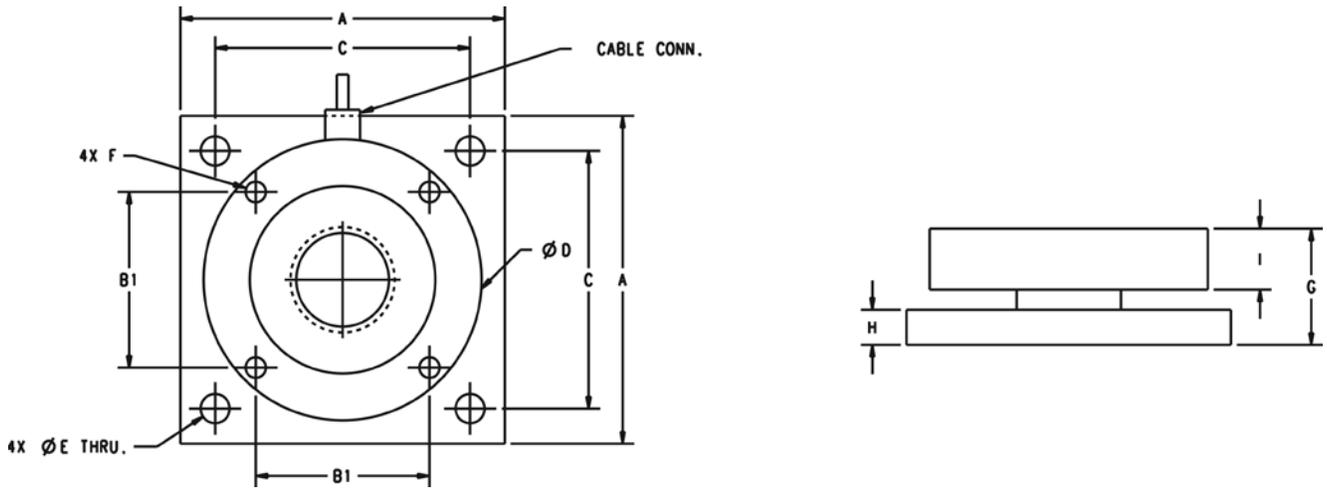

## Dimensions

RATED CAPACITY	A	B1	C	D	E	F	G	H	I	CONDUIT ADAPTER
<b>lb/inches</b>										
1k - 10k	4.00	2.00	3.25	3.50	0.40	3/8-16NC	1.35	0.375	0.75	—
15k	4.00	2.00	3.25	3.50	0.40	3/8-16NC	1.60	0.625	0.75	—
20k - 50k	7.00	3.75	5.50	6.00	0.63	1/2-13NC	2.48	0.750	1.30	1/2-14NPT

## RL2200 Series

Tank, Hopper and Vessel Weighing Assembly

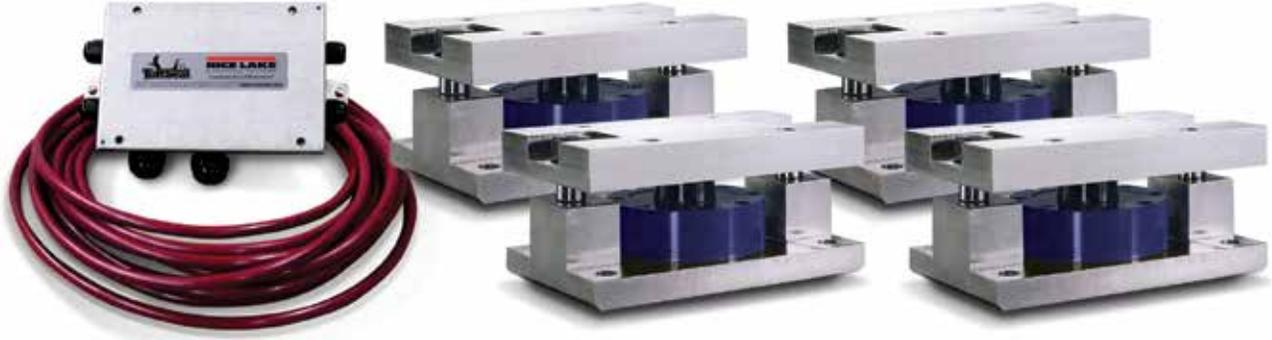

Available in configurations with three or four mounting assemblies.  
Picture is a representation of actual product

The RL2200 Series mounts are ideal for use in tank, hopper, vessel, and many other applications. The low-profile design allows for economical solutions in a competitive marketplace. This rugged, high-precision mount is designed for easy installation and does not require check rods or other stabilizing hardware. The RL2200 mount has the added feature of self centering, allowing for side loads without sacrificing performance.

### Load Cell Specifications

- Full Scale Output:**  
4.0 mV/V, 2.0 mV/V (2500 lb)
- Bridge Resistance:**  
350 ohms nominal
- Material/Finish:**  
High-alloy steel, painted
- Safe Overload:**  
150% Full Scale
- Rated Excitation:**  
10VDC (20V maximum)
- Nonlinearity:**  
0.05% Full Scale
- Hysteresis:**  
0.03% Full Scale
- Temperature:**  
Compensated range:  
15°F to 115°F/-9°C to 46°C
- Insulation Resistance:**  
5000 megohms
- Seal Type:**  
Environmentally sealed
- \*Cable Length:**  
30 ft/9.1 m
- Cable Color Code:**  
Red ..... + Excitation  
Black..... - Excitation  
White ..... + Signal  
Green ..... - Signal

**Warranty:**  
Two-year limited warranty  
\*Compression load application

### Standard Features

- Capacities: 2500-50,000 lb (1134-22,680 kg)
- Low-profile design
- High 4 mV/V output (2 mV/V, 2500 lb)
- Self-centering in all directions—able to withstand excessive side loads
- Self-checking assembly

### Applications

- Tank, hopper or vessel weighing
- Belt or roller conveyors
- Scale platforms and screw feeders

### Complete Kit Includes

- 1 JB4SS NEMA 4X stainless steel signal trim junction box
- 3 or 4 RL2200 high-alloy, zinc-plated steel mounting assemblies
- 3 or 4 RL2200 compression disk load cells
- 25 ft of our Hostile Environment EL147HE SURVIVOR® load cell cable

Assembly with integral RL2200  
compression disk load cell.



# RL2200 Series

Tank, Hopper and Vessel Weighing Assembly

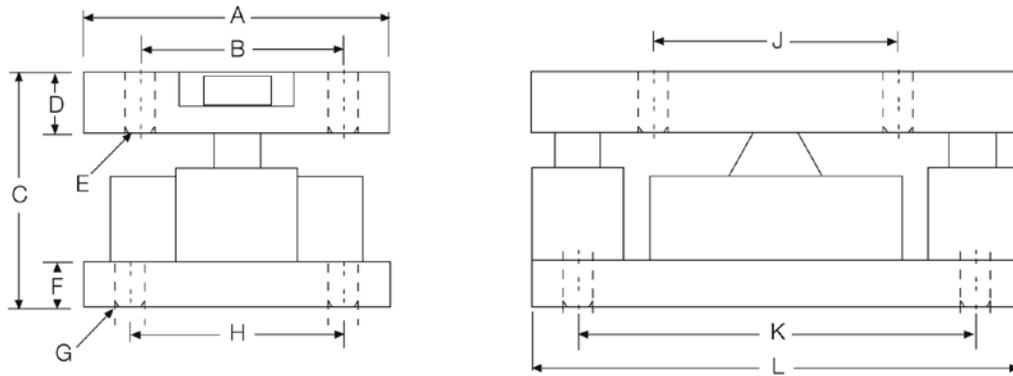

## Dimensions

RATED CAPACITY	A	B	C	D	E	F	G	H	J	K	L
<b>lb/inches</b>											
2500-10,000	5.0	3.50	4.00	1.00	.52	1.0	.52	3.50	4.00	6.50	8.0
25,000-50,000	6.0	4.50	5.00	1.25	.78	1.0	.78	4.50	5.00	7.75	10.0
<b>kg/mm</b>											
1134-4536	127.0	88.9	101.6	25.4	13.2	19.0	13.2	88.9	101.6	165.1	203.2
11,340-22,679.6	152.4	114.3	127.0	31.7	19.8	25.4	19.8	114.3	127.0	196.8	254.0

## Order Information

LOAD RATING (PER MODULE)	PART #	PRICE
<b>Single Module</b>		
2500 lb (1134 kg)	76656	\$1,575.00
5000 lb (2268 kg)	45849	1,575.00
10,000 lb (4536 kg)	45848	1,575.00
25,000 lb (11,340 kg)	45847	2,075.00
50,000 lb (22,680 kg)	45846	2,075.00
<b>3-Module Kit</b>		
2500 lb (1134 kg)	76897	4,700.00
5000 lb (2268 kg)	42811	4,700.00
10,000 lb (4536 kg)	42812	4,700.00
25,000 lb (11,340 kg)	42813	6,100.00
50,000 lb (22,680 kg)	42814	6,100.00
<b>4-Module Kit</b>		
2500 lb (1134 kg)	76898	6,215.00
5000 lb (2268 kg)	42815	6,215.00
10,000 lb (4536 kg)	42816	6,215.00
25,000 lb (11,340 kg)	42817	7,215.00
50,000 lb (22,680 kg)	42818	7,215.00

## Replacement Load Cell Order Information

LOAD RATING (PER MODULE)	PART #	PRICE
2500 lb (1134 kg)	76654	\$1,225.00
5000 lb (2268 kg)	45708	1,225.00
10,000 lb (4536 kg)	45709	1,225.00
25,000 lb (11,340 kg)	45710	1,525.00
50,000 lb (22,680 kg)	45711	1,525.00

## RL2200 SS Series

Stainless Steel, Tank, Hopper and Vessel Weighing Assembly



Available in configurations with three or four mounting assemblies.

Picture is a representation of actual product

The RL2200 SS Series mounts are ideal for use in tank, hopper, vessel and many other applications. The low-profile design allows for economical solutions in a competitive marketplace. This rugged, high-precision mount is designed for easy installation and does not require check rods or other stabilizing hardware. The RL2200 SS mount has the added feature of self centering, allowing for side loads without sacrificing performance.

Assembly with integral RL2200 SS compression disk load cell.



### Applications

- Tank, hopper or vessel weighing
- Belt or roller conveyors
- Scale platforms and screw feeders

### Complete Kit Includes

- 1 JB4SS NEMA 4X stainless steel signal trim junction box
- 3 or 4 RL2200 stainless steel mounting assemblies
- 3 or 4 RL2200 SS stainless steel, hermetically sealed, compression disk load cells
- 25 ft of our Hostile Environment EL147HE SURVIVOR® load cell cable

### Load Cell Specifications

**Full Scale Output:**

4.0 mV/V, 2.0 mV/V (2500 lb)

**Bridge Resistance:**

350 ohms nominal

**Material/Finish:**

Stainless steel

**Safe Overload:**

150% Full Scale

**Rated Excitation:**

10VDC (20V maximum)

**Nonlinearity:**

0.05% Full Scale

**Hysteresis:**

0.03% Full Scale

**Temperature:**

Compensated range:  
15°F to 115°F/9°C to 46°C

**Insulation Resistance:**

5000 megohms

**Seal Type:**

Hermetically sealed, IP66/68

**\*Cable Length:**

30 ft/9.1 m

**Cable Color Code:**

Red ..... + Excitation  
Black..... - Excitation  
White ..... + Signal  
Green ..... - Signal

**Warranty:**

Two-year limited warranty

\*Compression load application

# RL2200 SS Series

Stainless Steel, Tank, Hopper and Vessel Weighing Assembly

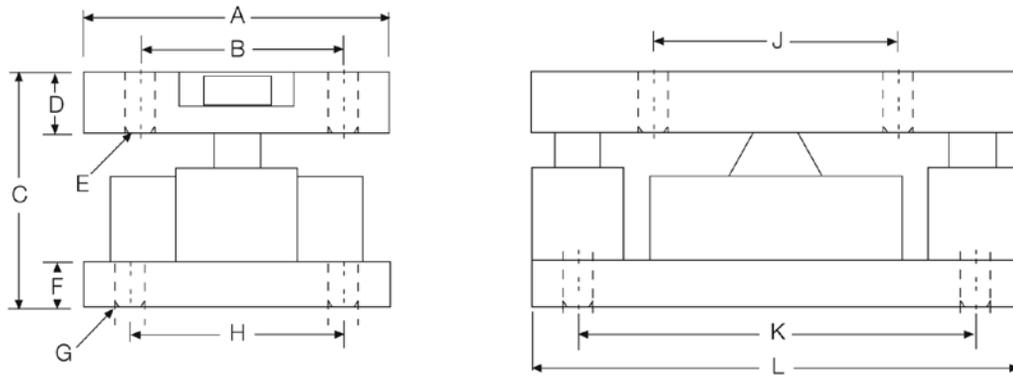

## Dimensions

RATED CAPACITY	A	B	C	D	E	F	G	H	J	K	L
<b>lb/inches</b>											
2500-10,000	5.00	3.50	4.00	1.00	.52	1.00	.52	3.50	4.00	6.50	8.00
25,000-50,000	6.00	4.50	5.00	1.25	.78	1.00	.78	4.50	5.00	7.75	10.00
<b>kg/mm</b>											
1134-4536	127.0	88.9	101.6	25.4	13.2	19.0	13.2	88.9	101.6	165.1	203.2
11,340-22,679.6	152.4	114.3	127.0	31.7	19.8	25.4	19.8	114.3	127.0	196.8	254.0

## Order Information

LOAD RATING (PER MODULE)	PART #	PRICE
<b>Single Module</b>		
2500 lb (1134 kg)	76657	\$2,295.00
5000 lb (2268 kg)	45845	2,295.00
10,000 lb (4536 kg)	45844	2,295.00
25,000 lb (11,340 kg)	45843	3,895.00
50,000 lb (22,680 kg)	45842	3,895.00
<b>3-Module Kit</b>		
2500 lb (1134 kg)	76899	6,495.00
5000 lb (2268 kg)	46478	6,495.00
10,000 lb (4536 kg)	46479	6,495.00
25,000 lb (11,340 kg)	46480	11,395.00
50,000 lb (22,680 kg)	46481	11,395.00
<b>4-Module Kit</b>		
2500 lb (1134 kg)	76900	8,595.00
5000 lb (2268 kg)	46482	8,595.00
10,000 lb (4536 kg)	46483	8,595.00
25,000 lb (11,340 kg)	46484	14,850.00
50,000 lb (22,680 kg)	46485	14,850.00

## Replacement Load Cell Order Information

LOAD RATING (PER MODULE)	PART #	PRICE
2500 lb (1134 kg)	76655	\$1,450.00
5000 lb (2268 kg)	45712	1,450.00
10,000 lb (4536 kg)	45713	1,450.00
25,000 lb (11,340 kg)	45714	2,395.00
50,000 lb (22,680 kg)	45715	2,395.00

# EZ Mount 1

Mild Steel



Available in configurations with three or four mounting assemblies.

Picture is a representation of actual product

The EZ Mount 1 Series weigh modules utilize the double-ended beam design with an articulating top plate to provide superior accuracy in any loading condition. The double-ended beam design means there is less cumbersome hardware and each module has a lower profile than modules of different configurations. NTEP Certified and FM approved RL70000 Series load cells give you accuracy and dependability in many applications, including intrinsically safe and explosion proof areas.

Module with RL70000 double-ended shear beam load cell.



## Complete Kit Includes

- 1 JB4SS NEMA 4X stainless steel signal trim junction box
- 3 or 4 EZ Mount 1 mild steel compression mounts
- 3 or 4 RL70000 double-ended shear beam load cells
- 25 ft of our Hostile Environment EL147HE SURVIVOR® load cell cable

## Applications

- Medium-to heavy-capacity tank and hopper weighing applications

## Standard Features

- Capacities (per module): 5000-250,000 lb (2268-113,398.1 kg)
- NTEP Certified load cells
- Unique sliding pin design compensates for thermal expansion/contraction
- Self-checking
- Easy load cell replacement
- Simplified design allows bolting directly to tank and floor
- Center-loaded double-ended shear beam design
- Low-profile design
- Painted mild steel construction

## Optional Features

- Kits available with Revere Transducers 5103 load cell, capacities in 5000-150,000 lb (2268.0-68,039.0 kg)

## Load Cell Certifications



NOTE: Check with your local weights and measure officials for suitability in Legal for Trade applications.



# EZ Mount 1

Mild Steel

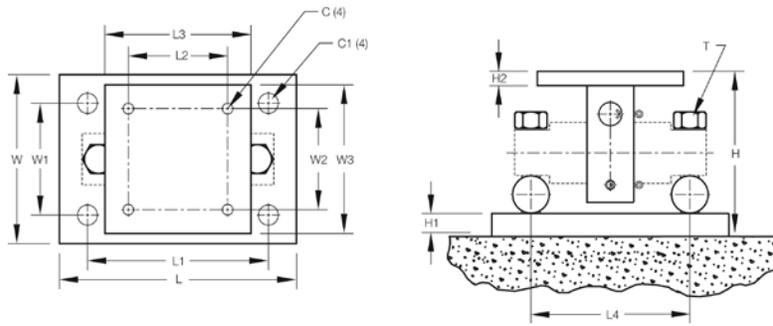

## Dimensions

RATED CAPACITY	C	C1	H	H1	H2	L	L1	L2	L3	L4	T	W	W1	W2	W3
<b>lb/inches</b>															
5000-20,000	.56	1.06	5.31	.75	.50	11.00	8.00	3.00	6.00	6.87	5/8-18 UNF	7.50	4.00	3.00	6.00
30,000-60,000	.68	1.19	8.43	1.00	.75	15.00	11.50	5.12	8.00	8.50	1-14 UNS	10.00	6.00	5.12	8.00
100,000	.81	1.38	10.37	1.25	1.25	18.00	14.00	7.50	10.00	9.50	1-14 UNS	12.00	9.00	7.50	10.00
150,000	.81	1.38	10.37	1.25	1.25	18.00	14.00	7.50	10.00	9.50	1-14 UNS	12.00	9.00	7.50	10.00
200,000-250,000	1.06	1.88	16.75	2.00	2.00	26.00	20.00	9.00	12.00	13.00	1 1/2-12 UNS	12.00	6.00	9.00	12.00
<b>kg/mm</b>															
2268.0-9071.9	14.2	26.9	134.9	19.1	12.7	279.4	203.2	76.2	152.4	174.5	5/8-18 UNF	190.5	101.6	76.2	152.4
13,607.8-27,215.5	17.3	30.2	214.1	25.4	19.1	381.0	292.1	130.0	203.2	215.9	1-14 UNS	254.0	152.4	130.1	203.2
45,359.2	20.6	35.1	263.4	31.8	31.8	457.2	355.6	190.5	254.0	241.3	1-14 UNS	304.8	228.6	190.5	254.0
68,039.0	20.6	35.1	263.4	31.8	31.8	457.2	355.6	190.5	254.0	241.3	1-14 UNS	304.8	228.6	190.5	254.0
90,718.5-113,398.1	26.9	47.8	425.5	50.8	50.8	660.4	508.0	228.6	304.8	330.2	1 1/2-12 UNS	304.8	152.4	228.6	304.8

## EZ Mount 1 Mild Steel Order Information

LOAD RATING (PER MODULE)	PART #	PRICE
<b>Single Module (Does NOT Include Load Cell)</b>		
5000-20,000 lb (2268.0-9071.9 kg)	17823	\$295.00
30,000-60,000 lb (13,607.8-27,215.5 kg)	17824	795.00
100,000 lb (45,359.2 kg)	17850	1,095.00
150,000 lb (68,039.0 kg)	29012	1,095.00
200,000-250,000 lb (90,719-113,398.4 kg)	26068	2,495.00
<b>3-Module Kit</b>		
5000 lb (2268.0 kg)	18163	2,875.00
10,000 lb (4535.9 kg)	18164	2,875.00
20,000 lb (9071.9 kg)	18165	2,875.00
30,000 lb (13,607.8 kg)	32164	4,545.00
40,000 lb (18,143.7 kg)	32167	4,545.00
50,000 lb (22,679.6 kg)	18166	4,545.00
60,000 lb (27,215.5 kg)	18167	4,545.00
100,000 lb (45,359.2 kg)	18168	7,395.00
150,000 lb (68,040 kg)	43290	7,395.00
<b>4-Module Kit</b>		
5000 lb (2268.0 kg)	18169	3,735.00
10,000 lb (4535.9 kg)	18170	3,735.00
20,000 lb (9071.9 kg)	18171	3,735.00
30,000 lb (13,607.8 kg)	32165	5,765.00
40,000 lb (18,143.7 kg)	32166	5,765.00
50,000 lb (22,679.6 kg)	18172	5,765.00
60,000 lb (27,215.5 kg)	18173	5,765.00
100,000 lb (45,359.2 kg)	18174	9,665.00
150,000 lb (68,040 kg)	43291	9,665.00

## RTI EZ Mount 1 Mild Steel Order Information

LOAD RATING (PER MODULE)	PART #	PRICE
<b>3-Module Kit</b>		
5000 lb (2268.0 kg)	18175	\$2,975.00
10,000 lb (4535.9 kg)	18176	2,975.00
20,000 lb (9071.9 kg)	18177	2,975.00
30,000 lb (13,607.8 kg)	32169	4,645.00
40,000 lb (18,143.7 kg)	32171	4,645.00
50,000 lb (22,679.6 kg)	18178	4,795.00
60,000 lb (27,215.5 kg)	18179	4,795.00
100,000 lb (45,359.2 kg)	18180	7,495.00
150,000 lb (68,039.0 kg)	18181	7,495.00
<b>4-Module Kit</b>		
5000 lb (2268.0 kg)	18182	3,835.00
10,000 lb (4535.9 kg)	18183	3,835.00
20,000 lb (9071.9 kg)	18184	3,835.00
30,000 lb (13,607.8 kg)	32170	5,865.00
40,000 lb (18,143.7 kg)	32172	5,865.00
50,000 lb (22,679.6 kg)	18185	6,035.00
60,000 lb (27,215.5 kg)	18186	6,035.00
100,000 lb (45,359.2 kg)	18187	9,765.00
150,000 lb (68,039.0 kg)	18188	9,765.00
<b>Dummy Load Cells</b>		
5000-20,000 lb	33749	75.00
30,000-60,000 lb	74016	95.00
100,000 lb	94175	150.00
150,000 lb	158715	225.00
<b>Grounding Kit</b>		
126419	5K-60K, includes ground strap and mounting hardware	15.45

# EZ Mount 1

Stainless Steel



Available in configurations with three or four mounting assemblies.

Picture is a representation of actual product

The EZ Mount 1 Series weigh modules utilize the double-ended beam design with an articulating top plate to provide superior accuracy in any loading condition. The double-ended beam design means there is less cumbersome hardware and each module has a lower profile than modules of different configurations. FM approved RL70000 SS Series load cells give you accuracy and dependability in many applications, including intrinsically safe and explosion proof areas.

Module with RL70000 SS double-ended shear beam load cell.

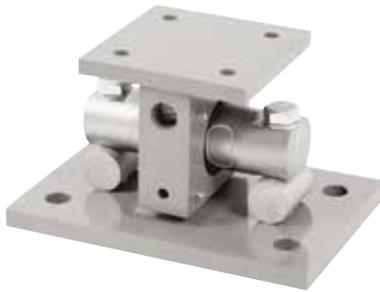

## Complete Kit Includes

- 1 JB4SS NEMA 4X stainless steel signal trim junction box
- 3 or 4 EZ Mount 1 stainless steel compression mounts
- 3 or 4 RL70000 SS stainless steel double-ended shear beam load cells
- 25 ft of our Hostile Environment EL147HE SURVIVOR® load cell cable

## Applications

- Medium to heavy-capacity tank and hopper weighing applications

## Standard Features

- Capacities (per module): 5000-150,000 lb (2268-60,039.0 kg)
- Unique sliding pin design compensates for thermal expansion/contraction
- NTEP Certified load cells (10K - 100K)
- Self-checking
- Easy load cell replacement
- Simplified design allows bolting directly to tank and floor
- Center-loaded double-ended shear beam design
- Low-profile design
- 304 stainless steel construction

## Optional Features

- Kits available with Revere Transducers 9103 load cell, capacities in 5000-150,000 lb (2268.0-68,039.0 kg)

## Load Cell Certifications



NOTE: Check with your local weights and measure officials for suitability in Legal for Trade applications.

# EZ Mount 1

Stainless Steel

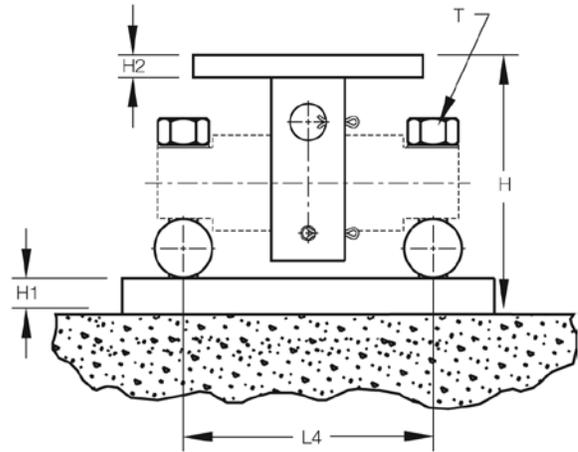
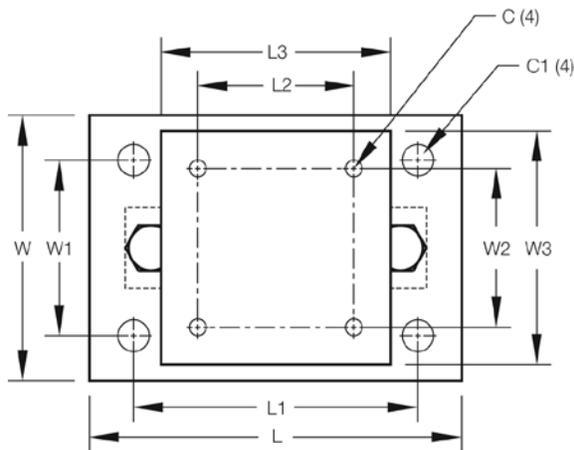

## Dimensions

RATED CAPACITY	C	C1	H	H1	H2	L	L1	L2	L3	L4	T	W	W1	W2	W3
<b>lb/inches</b>															
5000-20,000	.56	1.06	5.31	.75	.50	11.00	8.00	3.00	6.00	6.87	5/8-18 UNF	7.50	4.00	3.00	6.00
30,000-60,000	.68	1.19	8.43	1.00	.75	15.00	11.50	5.12	8.00	8.50	1-14 UNS	10.00	6.00	5.12	8.00
100,000	.81	1.38	10.37	1.25	1.25	18.00	14.00	7.50	10.00	9.50	1-14 UNS	12.00	9.00	7.50	10.00
150,000	.81	1.38	10.37	1.25	1.25	18.00	14.00	7.50	10.00	9.50	1-14 UNS	12.00	9.00	7.50	10.00
<b>kg/mm</b>															
2268.0-9071.9	14.2	26.9	134.9	19.1	12.7	279.4	203.2	76.2	152.4	174.5	5/8-18 UNF	190.5	101.6	76.2	152.4
13,607.8-27,215.5	17.3	30.2	214.1	25.4	19.1	381.0	292.1	130.0	203.2	215.9	1-14 UNS	254.0	152.4	130.1	203.2
45,359.2	20.6	35.1	263.4	31.8	31.8	457.2	355.6	190.5	254.0	241.3	1-14 UNS	304.8	228.6	190.5	254.0
68,039.0	20.6	35.1	263.4	31.8	31.8	457.2	355.6	190.5	254.0	241.3	1-14 UNS	304.8	228.6	190.5	254.0

## Order Information

LOAD RATING (PER MODULE)		PART #	PRICE
<b>Single Module (Does NOT Include Load Cell)</b>			
5000-20,000 lb	(2268.0-9071.9 kg)	17943	\$725.00
30,000-60,000 lb	(13,607.8-27,215.5 kg)	17944	1,995.00
100,000 lb	(45,359.2 kg)	17945	3,695.00
150,000 lb	(68,039.0 kg)	29011	3,695.00
<b>3-Module Kit</b>			
5000 lb	(2268.0 kg)	36195	4,325.00
10,000 lb	(4535.9 kg)	36196	4,325.00
20,000 lb	(9071.9 kg)	36197	4,325.00
30,000 lb	(13,607.8 kg)	36198	8,295.00
40,000 lb	(18,143.7 kg)	36199	8,295.00
50,000 lb	(22,679.6 kg)	36200	8,395.00
60,000 lb	(27,215.5 kg)	36201	8,395.00
100,000 lb	(45,359.2 kg)	36202	13,295.00
150,000 lb	(68,039.0 kg)	43288	13,295.00

## Order Information

LOAD RATING (PER MODULE)		PART #	PRICE
<b>4-Module Kit</b>			
5000 lb	(2268.0 kg)	36203	\$5,800.00
10,000 lb	(4535.9 kg)	36204	5,800.00
20,000 lb	(9071.9 kg)	36205	5,800.00
30,000 lb	(13,607.8 kg)	36206	11,275.00
40,000 lb	(18,143.7 kg)	36207	11,275.00
50,000 lb	(22,679.6 kg)	36208	11,550.00
60,000 lb	(27,215.5 kg)	36209	11,550.00
100,000 lb	(45,359.2 kg)	36210	17,650.00
150,000 lb	(68,039.0 kg)	43289	17,650.00
<b>Dummy Load Cells (Mild Steel)</b>			
5000-20,000 lb	—	33749	75.00
30,000-60,000 lb	—	74016	95.00
100,000 lb	—	94175	150.00
150,000 lb	—	158715	225.00

## EZ Mount 1 HE

Stainless Steel, Hermetically Sealed



Available in configurations with three or four mounting assemblies.

Picture is a representation of actual product

The EZ Mount 1 HE Series weigh modules utilize the double-ended beam design with an articulating top plate to provide superior accuracy in any loading condition. The double-ended beam design means there is less cumbersome hardware and each module has a lower profile than modules of different configurations. The RL72010 MH Series load cells give you accuracy and dependability in any environment. Their stainless steel, hermetically sealed design also make them the ideal solution in harsh environments where moisture is present.

Module with RL72010MH double-ended shear beam load cell.



### Complete Kit Includes

- 1 JB4SS NEMA 4X stainless steel signal trim junction box
- 3 or 4 EZ Mount 1 stainless steel compression mounts
- 3 or 4 RL72010 MH hermetically sealed stainless steel double-ended shear beam load cells
- 25 ft of our Hostile Environment EL147HE SURVIVOR® load cell cable

### Applications

- Medium to heavy-capacity tank and hopper weighing applications

### Standard Features

- Capacities (per module): 5000-60,000 lb (2268-27,216.0 kg)
- Unique sliding pin design compensates for thermal expansion/contraction
- Self-checking
- Easy load cell replacement
- Simplified design allows bolting directly to tank and floor
- Center-loaded, double-ended shear beam design
- Low-profile design
- 304 stainless steel construction

### Load Cell Certifications



# EZ Mount 1 HE

Stainless Steel, Hermetically Sealed

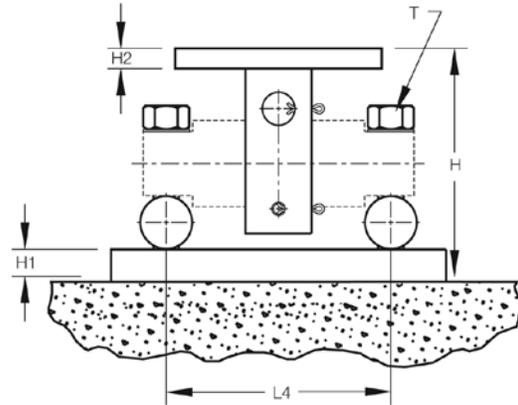
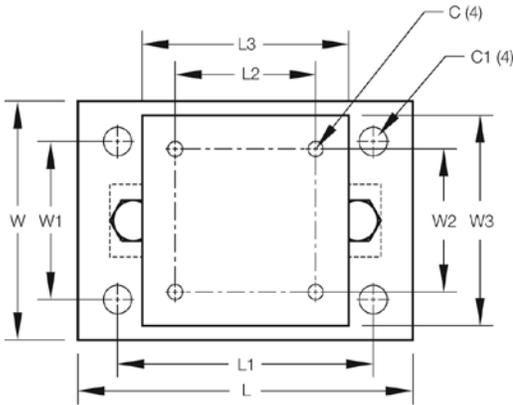

## Dimensions

RATED CAPACITY	C	C1	H	H1	H2	L	L1	L2	L3	L4	T	W	W1	W2	W3
<b>lb/inches</b>															
5000-20,000	.56	1.06	5.31	.75	.50	11.00	8.00	3.00	6.00	6.87	5/8-18 UNF	7.50	4.00	3.00	6.00
30,000-60,000	.68	1.19	8.43	1.00	.75	15.00	11.50	5.12	8.00	8.50	1-14 UNS	10.00	6.00	5.12	8.00
<b>kg/mm</b>															
2268.0-9071.9	14.2	26.9	134.9	19.1	12.7	279.4	203.2	76.2	152.4	174.5	5/8-18 UNF	190.5	101.6	76.2	152.4
13,607.8-27,215.5	17.3	30.2	214.1	25.4	19.1	381.0	292.1	130.0	203.2	215.9	1-14 UNS	254.0	152.4	130.1	203.2

NOTES: • Mounting bolts (T) may project on lower side of base plate • Foundation plate not included

## Order Information

LOAD RATING (PER MODULE)	PART #	PRICE
<b>3-Module Kit</b>		
5000 lb (2268.0 kg)	46695	\$5,595.00
10,000 lb (4535.9 kg)	46696	5,595.00
20,000 lb (9071.9 kg)	46697	5,595.00
30,000 lb (13,607.8 kg)	46698	10,595.00
40,000 lb (18,143.7 kg)	46699	10,595.00
50,000 lb (22,679.6 kg)	46700	10,595.00
60,000 lb (27,215.5 kg)	46701	10,595.00
<b>4-Module Kit</b>		
5000 lb (2268.0 kg)	46702	7,495.00
10,000 lb (4535.9 kg)	46703	7,495.00
20,000 lb (9071.9 kg)	46704	7,495.00
30,000 lb (13,607.8 kg)	46705	13,995.00
40,000 lb (18,143.7 kg)	46706	13,995.00
50,000 lb (22,679.6 kg)	46707	13,995.00
60,000 lb (27,215.5 kg)	46708	13,995.00
<b>Dummy Load Cells (Mild Steel)</b>		
5000-20,000 lb (2268.0-9071.9 kg)	33749	75.00
30,000-60,000 lb (13,607.8-27,215.5 kg)	74016	95.00

## Shims

	PART #	PRICE
<b>STAINLESS STEEL</b>		
<b>5K-20K</b>		
0.0625 in	150886	\$7.25
0.125 in	150888	11.50
0.250 in	150889	24.00
<b>30K-60K</b>		
0.0625 in	150890	12.75
0.125 in	150891	20.50
0.250 in	150892	57.00
<b>100K-150K</b>		
0.0625 in	150893	20.25
0.125 in	150894	32.50
0.250 in	150896	89.00
<b>MILD STEEL</b>		
<b>5K-20K</b>		
0.0625 in	150874	1.75
0.125 in	150876	3.50
0.250 in	150877	3.75
<b>30K-60K</b>		
0.0625 in	150878	3.50
0.125 in	150880	6.00
0.250 in	150881	6.50
<b>100K-150K</b>		
0.0625 in	150882	5.50
0.125 in	150884	9.50
0.250 in	150885	10.25

# RL1600 Series

Cast Iron



Available in configurations with three or four mounting assemblies.  
Picture is a representation of actual product

The RL1600 Series Mounting Module Kit utilizes several Rice Lake Weighing Systems components to provide an unmatched level of performance in tank and hopper weighing applications. The RL1600 Series kit is ideally suited for indoor and outdoor process control operations in the medium-to high-capacity ranges. Each module incorporates self-checking capabilities for thermal expansion and contraction.

Cast iron module with  
RL75016 double-ended beam  
load cell.

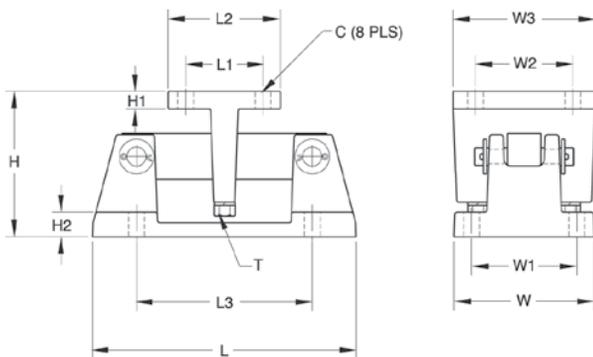

## Dimensions

RATED CAPACITY	C	H	H1	H2	L	L1	L2	L3	T	W	W1	W2	W3
<b>lb/inches</b>													
1000-5000	.56	5.00	.50	.50	9.31	2.75	4.00	6.25	1/2-13UNC	5.00	3.75	2.75	4.00
10,000-25,000	.78	7.89	.75	.75	12.00	6.00	8.00	7.50	3/4-10UNC	8.00	6.00	6.00	8.00
<b>kg/mm</b>													
453.6-2268.0	14.2	127.0	12.7	12.7	236.5	69.9	101.6	158.8	1/2-13UNC	127.0	95.3	69.9	101.6
4535.9-11,339.8	19.8	200.4	19.1	19.1	304.8	152.4	203.2	190.5	3/4-10UNC	203.2	152.4	152.4	203.2

## Complete Kit Includes

- 1 JB4SS NEMA 4X stainless steel signal trim junction box
- 3 or 4 RL1600 cast iron compression mounts
- 3 or 4 RL75016 double-ended shear beam load cells
- 25ft of our Hostile Environment EL147HE SURVIVOR® load cell cable

## Applications

- Medium to heavy-capacity tanks, bins, and hoppers
- Bulk material management

## Standard Features

- Capacities (per module): 1000-25,000 lb (453.6-11,339.8 kg)
- Cast iron construction
- Self-checking easy-to-use design allows module to be bolted directly to tank leg without requiring additional mounting plates or load buttons
- Environmentally protected load cells
- Double-ended beam design, center loaded

## Optional Features

- Kits available with Vishay Sensortronics 65016 load cells, capacities (per module): 1000-25,000 lb (453.6-11,339.8 kg)

## Load Cell Certifications



# RL1600 Series

Cast Iron

## Order Information

LOAD RATING (PER MODULE)		PART #	PRICE
<b>Single Module (Does NOT Include Load Cell)</b>			
1000-5000 lb	(453.6-2268.0 kg)	17964	\$150.00
10,000-25,000 lb	(4535.9-11,339.8 kg)	17965	290.00
<b>3-Module Kit</b>			
1000 lb	(453.6 kg)	25663	1,995.00
1500 lb	(680.4 kg)	25664	1,995.00
2000 lb	(907.2 kg)	25665	1,995.00
2500 lb	(1134.0 kg)	25666	1,995.00
3000 lb	(1360.8 kg)	25667	1,995.00
5000 lb	(2268.0 kg)	25668	1,995.00
10,000 lb	(4535.9 kg)	25669	2,595.00
15,000 lb	(6803.9 kg)	25671	2,595.00
20,000 lb	(9071.9 kg)	25672	2,595.00
25,000 lb	(11,339.8 kg)	25674	2,595.00
<b>4-Module Kit</b>			
1000 lb	(453.6 kg)	25675	2,550.00
1500 lb	(680.4 kg)	25676	2,550.00
2000 lb	(907.2 kg)	25677	2,550.00
2500 lb	(1134.0 kg)	25678	2,550.00
3000 lb	(1360.8 kg)	25679	2,550.00
5000 lb	(2268.0 kg)	25680	2,550.00
10,000 lb	(4535.9 kg)	25681	3,350.00
15,000 lb	(6803.9 kg)	25682	3,350.00
20,000 lb	(9071.9 kg)	25683	3,350.00
25,000 lb	(11,339.8 kg)	25684	3,350.00

## Load Cell Upgrade

<b>RL75016SS Stainless Load Cells</b>
3 mount kits \$75.00 added to list price
4 mount kits \$100.00 added to list price
<b>RL75016WHE Stainless Hermetic Load Cells</b>
3 mount kits 1k-5k \$390.00, 10k-25k \$435.00 added to list price
4 mount kits 1k-5k \$520.00, 10k-25k \$580.00 added to list price

# VPG Sensortronics 65016

## Order Information

LOAD RATING (PER MODULE)		PART #	PRICE
<b>3-Module Kit</b>			
1000 lb	(453.6 kg)	25685	\$2,350.00
1500 lb	(680.4 kg)	25686	2,350.00
2500 lb	(1134.0 kg)	25688	2,350.00
5000 lb	(2268.0 kg)	25690	2,350.00
10,000 lb	(4535.9 kg)	25691	2,950.00
15,000 lb	(6803.9 kg)	25692	2,950.00
20,000 lb	(9071.9 kg)	25693	2,950.00
25,000 lb	(11,339.8 kg)	25694	2,950.00
<b>4-Module Kit</b>			
1000 lb	(453.6 kg)	25695	3,050.00
1500 lb	(680.4 kg)	25696	3,050.00
2500 lb	(1134.0 kg)	25698	3,050.00
5000 lb	(2268.0 kg)	25700	3,050.00
10,000 lb	(4535.9 kg)	25701	3,875.00
15,000 lb	(6803.9 kg)	25702	3,875.00
20,000 lb	(9071.9 kg)	25703	3,875.00
25,000 lb	(11,339.8 kg)	25704	3,875.00
<b>Dummy Load Cells</b>			
1000-5000 lb	(453.6-2268.0 kg)	18236	20.00
10,000-25,000 lb	(4535.9-11,339.8 kg)	18237	35.00
<b>Equalizer Pads</b>			
1000 lb-5000 lb		67152	35.00
10,000 lb-25,000 lb		67153	50.00

## Shims, Mild Steel

	PART #	PRICE
<b>1K-5K</b>		
0.0625	150844	\$1.00
0.125	150845	1.50
0.250	150846	1.75
<b>10K-25K</b>		
0.0625	150847	3.50
0.125	150848	6.00
0.250	150849	6.50

# RL1600 Series

Mild Steel

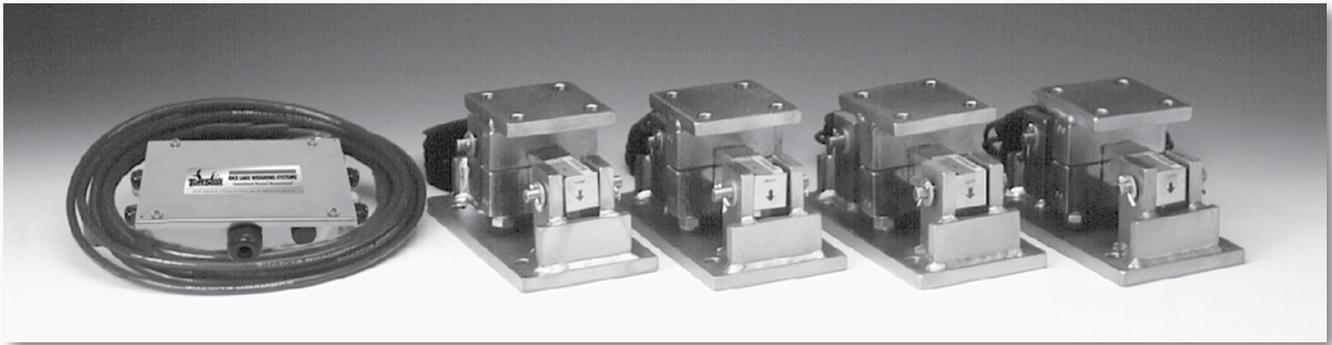

Available in configurations with three or four mounting assemblies.

Picture is a representation of actual product

The RL1600 Series Mounting Module Kit utilizes several Rice Lake Weighing Systems components to provide an unmatched level of performance in tank and hopper weighing applications. The RL1600 Series kit is ideally suited for indoor and outdoor process control operations in the medium-to high-capacity ranges. Each module incorporates self-checking capabilities for thermal expansion and contraction.

Mild steel module with RL75016 double-ended beam load cell.

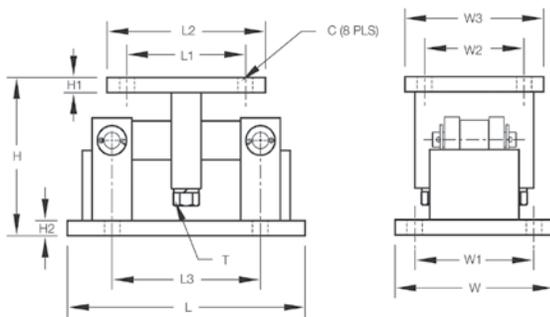

## Dimensions

RATED CAPACITY	C	H	H1	H2	L	L1	L2	L3	T	W	W1	W2	W3
<b>lb/inches</b>													
1000-5000	.56	5.00	.50	.50	9.25	2.75	4.00	6.25	1/2-13 UNC	5.00	3.75	2.75	4.00
10,000-25,000	.78	7.87	.75	.75	12.00	6.00	8.00	7.50	3/4-10 UNC	8.00	6.00	6.00	8.00
50,000-75,000	.78	9.31	1.00	1.00	16.25	6.50	9.00	11.50	1 1/4-7 UNC	12.00	9.50	6.50	9.00
<b>kg/mm</b>													
453.6-2268.0	14.2	127.0	12.7	12.7	235.0	69.9	101.6	158.8	1/2-13 UNC	127.0	95.3	69.9	101.6
4535.9-11,339.8	19.8	199.9	19.1	19.1	304.8	152.4	203.2	190.5	3/4-10 UNC	203.2	152.4	152.4	203.2
22,679.7-34,019.5	19.8	236.5	25.4	25.4	412.8	165.1	228.6	292.1	1 1/4-7 UNC	304.8	241.3	165.1	228.6

## Complete Kit Includes

- 1 JB4SS NEMA 4X stainless steel signal trim junction box
- 3 or 4 RL1600 mild steel compression mounts
- 3 or 4 RL75016 double-ended shear beam load cells
- 25 ft of our Hostile Environment EL147HE SURVIVOR® load cell cable

## Applications

- Medium-to heavy-capacity tanks, bins and hoppers
- Bulk material management

## Standard Features

- Capacities (per module): 1000-75,000 lb (453.6-34,019.5 kg)
- Self-checking, easy-to-use design allows module to be bolted directly to tank leg without requiring additional mounting plates or load buttons
- Environmentally protected load cells
- Double-ended shear beam design, center loaded
- Painted mild steel construction

## Optional Features

- Kits available with Vishay Sensortronics 65016 load cells, capacities (per module): 1000-75,000 lb (453.6-34,019.5 kg)

## Load Cell Certifications





# RL1600 Series

Mild Steel

## Order Information

LOAD RATING (PER MODULE)		PART #	PRICE
<b>Single Module (Does NOT Include Load Cell)</b>			
1000-5000 lb	(453.6-2268.0 kg)	17812	\$150.00
10,000-25,000 lb	(4535.9-11,339.8 kg)	17814	290.00
50,000 lb	(22,679.6 kg)	17816	975.00
75,000 lb	(34,019.5 kg)	25346	975.00
<b>3-Module Kit</b>			
1000 lb	(453.6 kg)	18117	1,995.00
1500 lb	(680.4 kg)	18118	1,995.00
2000 lb	(907.2 kg)	18119	1,995.00
2500 lb	(1134.0 kg)	18120	1,995.00
3000 lb	(1360.8 kg)	18121	1,995.00
5000 lb	(2268.0 kg)	18122	1,995.00
10,000 lb	(4535.9 kg)	18123	2,595.00
15,000 lb	(6803.9 kg)	18124	2,595.00
20,000 lb	(9071.9 kg)	18125	2,595.00
25,000 lb	(11,339.8 kg)	18126	2,595.00
50,000 lb	(22,679.6 kg)	18127	5,350.00
75,000 lb	(34,019.5 kg)	25348	5,350.00
<b>4-Module Kit</b>			
1000 lb	(453.6 kg)	18129	2,550.00
1500 lb	(680.4 kg)	18130	2,550.00
2000 lb	(907.2 kg)	18131	2,550.00
2500 lb	(1134.0 kg)	18132	2,550.00
3000 lb	(1360.8 kg)	18133	2,550.00
5000 lb	(2268.0 kg)	18134	2,550.00
10,000 lb	(4535.9 kg)	18135	3,350.00
15,000 lb	(6803.9 kg)	18136	3,350.00
20,000 lb	(9071.9 kg)	18137	3,350.00
25,000 lb	(11,339.8 kg)	18138	3,350.00
50,000 lb	(22,679.6 kg)	18139	7,150.00
75,000 lb	(34,019.5 kg)	25349	7,150.00

## Load Cell Upgrade

<b>RL75016SS Stainless Load Cells</b>	
3 mount kits \$75.00 added to list price	
4 mount kits \$100.00 added to list price	
<b>RL75016WHE Stainless Hermetic Load Cells</b>	
3 mount kits 1k-5k \$390.00, 10k-25k \$435.00 added to list price	
4 mount kits 1k-5k \$520.00, 10k-25k \$580.00 added to list price	

# VPG Sensortronics 65016

## Order Information

LOAD RATING (PER MODULE)		PART #	PRICE
<b>3-Module Kit</b>			
1000 lb	(453.6 kg)	18189	\$2,350.00
1500 lb	(680.4 kg)	18190	2,350.00
2500 lb	(1134.0 kg)	18192	2,350.00
5000 lb	(2268.0 kg)	18194	2,350.00
10,000 lb	(4535.9 kg)	18195	2,950.00
15,000 lb	(6803.9 kg)	18196	2,950.00
20,000 lb	(9071.9 kg)	18197	2,950.00
25,000 lb	(11,339.8 kg)	18198	2,950.00
50,000 lb	(22,679.6 kg)	18199	5,795.00
75,000 lb	(34,019.5 kg)	25350	5,795.00
<b>4-Module Kit</b>			
1000 lb	(453.6 kg)	18201	3,050.00
1500 lb	(680.4 kg)	18202	3,050.00
2500 lb	(1134.0 kg)	18204	3,050.00
5000 lb	(2268.0 kg)	18206	3,050.00
10,000 lb	(4535.9 kg)	18207	3,875.00
15,000 lb	(6803.9 kg)	18208	3,875.00
20,000 lb	(9071.9 kg)	18209	3,875.00
25,000 lb	(11,339.8 kg)	18210	3,875.00
50,000 lb	(22,679.6 kg)	18211	7,595.00
75,000 lb	(34,019.5 kg)	25351	7,595.00
<b>Dummy Load Cells</b>			
1000-5000 lb	(453.6-2268.0 kg)	18236	20.00
10,000-25,000 lb	(4535.9-11,339.8 kg)	18237	35.00
50,000 lb	(22,679.6 kg)	18238	50.00
<b>Equalizer Pads</b>			
1000 lb-5000 lb		67152	35.00
10,000 lb-25,000 lb		67153	50.00

## Shims, Mild Steel

	PART #	PRICE
<b>1K-5K</b>		
0.0625	150844	\$1.00
0.125	150845	1.50
0.250	150846	1.75
<b>10K-25K</b>		
0.0625	150847	3.50
0.125	150848	6.00
0.250	150849	6.50
<b>50K-75K</b>		
0.0625	150850	4.50
0.125	150851	7.50
0.250	150866	6.00

# RL1600 Series

Stainless Steel

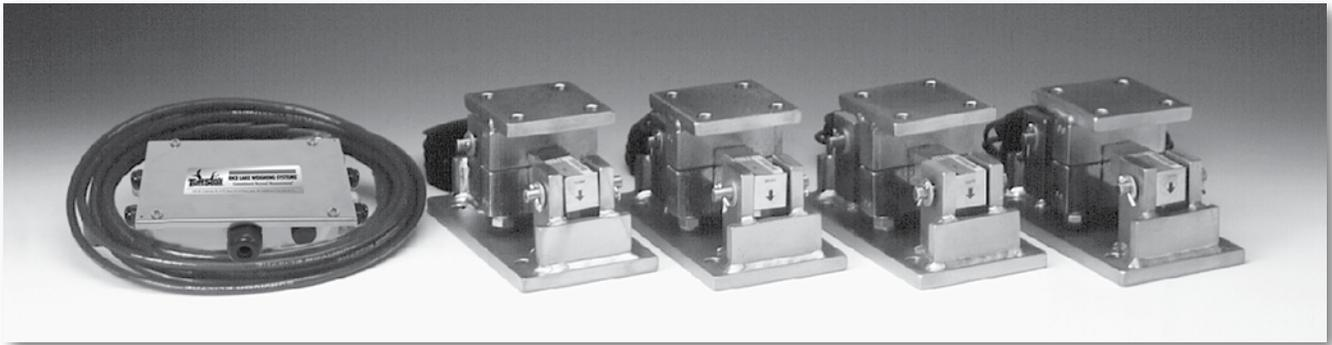

Available in configurations with three or four mounting assemblies.

Picture is a representation of actual product

The RL1600 Series Mounting Module Kit utilizes several Rice Lake Weighing Systems components to provide an unmatched level of performance in tank and hopper weighing applications. The RL1600 Series kit is ideally suited for indoor and outdoor process control operations in the medium-to high-capacity ranges. Each module incorporates self-checking capabilities for thermal expansion and contraction.

Fabricated stainless steel module with RL75016 SS double-ended beam load cell.

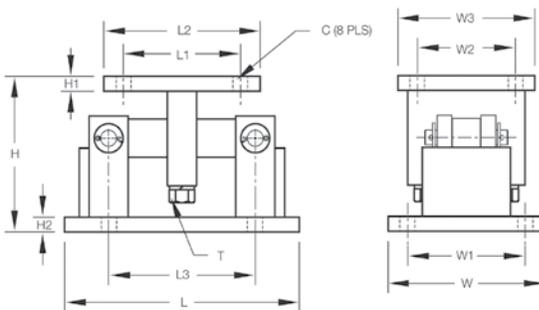

## Dimensions

RATED CAPACITY	C	H	H1	H2	L	L1	L2	L3	T	W	W1	W2	W3
<b>lb/inches</b>													
1000-5000	.56	5.00	.50	.50	9.25	2.75	4.00	6.25	1/2-13 UNC	5.00	3.75	2.75	4.00
10,000-25,000	.78	7.87	.75	.75	12.00	6.00	8.00	7.50	3/4-10 UNC	8.00	6.00	6.00	8.00
50,000-75,000	.78	9.31	1.00	1.00	16.25	6.50	9.00	11.50	1 1/4-7 UNC	12.00	9.50	6.50	9.00
<b>kg/mm</b>													
453.6-2268.0	14.2	127.0	12.7	12.7	235.0	69.9	101.6	158.8	1/2-13 UNC	127.0	95.3	69.9	101.6
4535.9-11,339.8	19.8	199.9	19.1	19.1	304.8	152.4	203.2	190.5	3/4-10 UNC	203.2	152.4	152.4	203.2
22,679.7-34,019.5	19.8	236.5	25.4	25.4	412.8	165.1	228.6	292.1	1 1/4-7 UNC	304.8	241.3	165.1	228.6

## Complete Kit Includes

- 1 JB4SS NEMA 4X stainless steel signal trim junction box
- 3 or 4 RL1600 stainless steel compression mounts
- 3 or 4 RL75016 SS stainless steel double-ended shear beam load cells
- 25 ft of our Hostile Environment EL147HE SURVIVOR® load cell cable

## Applications

- Medium-to heavy-capacity tanks, bins, and hoppers
- Bulk material management

## Standard Features

- Capacities (per module): 1000-75,000 lb (453.6-34,019.5 kg)
- 304 stainless steel construction
- Self-checking, easy-to-use design allows module to be bolted directly to tank leg without requiring additional mounting plates or load buttons
- Environmentally protected load cells
- Double-ended shear beam design, center loaded

## Optional Features

- Kits available with Vishay Sensortronics 65016W SS load cells

## Load Cell Certifications



Rice Lake load cells only

# RL1600 Series

Stainless Steel

## Order Information

LOAD RATING (PER MODULE)		PART #	PRICE
<b>Single Module (Does NOT include Load Cell)</b>			
1000-5000 lb	(453.6-2268.0 kg)	17813	\$565.00
10,000-25,000 lb	(4535.9-11,339.8 kg)	17815	1,095.00
50,000 lb	(22,679.6 kg)	17842	2,595.00
75,000 lb	(34,019.5 kg)	25347	2,595.00
<b>3-Module Kit</b>			
1000 lb	(453.6 kg)	18141	3,250.00
1500 lb	(680.4 kg)	18142	3,250.00
2000 lb	(907.2 kg)	18143	3,250.00
2500 lb	(1134.0 kg)	18144	3,250.00
5000 lb	(2268.0 kg)	18145	3,250.00
10,000 lb	(4535.9 kg)	18146	4,895.00
15,000 lb	(6803.9 kg)	18147	4,895.00
20,000 lb	(9071.9 kg)	18148	4,895.00
25,000 lb	(11,339.8 kg)	18149	4,895.00
50,000 lb	(22,679.6 kg)	18150	10,995.00
75,000 lb	(34,019.5 kg)	25352	10,995.00
<b>4-Module Kit</b>			
1000 lb	(453.6 kg)	18152	4,195.00
1500 lb	(680.4 kg)	18153	4,195.00
2000 lb	(907.2 kg)	18154	4,195.00
2500 lb	(1134.0 kg)	18155	4,195.00
5000 lb	(2268.0 kg)	18156	4,195.00
10,000 lb	(4535.9 kg)	18157	6,695.00
15,000 lb	(6803.9 kg)	18158	6,695.00
20,000 lb	(9071.9 kg)	18159	6,695.00
25,000 lb	(11,339.8 kg)	18160	6,695.00
50,000 lb	(22,679.6 kg)	18161	14,995.00
75,000 lb	(34,019.5 kg)	25353	14,995.00

# VPG Sensortronics 65016W

## Order Information

LOAD RATING (PER MODULE)		PART #	PRICE
<b>3-Module Kit</b>			
1000 lb	(453.6 kg)	18213	\$3,495.00
1500 lb	(680.4 kg)	18214	3,495.00
2500 lb	(1134.0 kg)	18216	3,495.00
5000 lb	(2268.0 kg)	18217	3,495.00
10,000 lb	(4535.9 kg)	18218	5,295.00
15,000 lb	(6803.9 kg)	18219	5,295.00
20,000 lb	(9071.9 kg)	18220	5,295.00
25,000 lb	(11,339.8 kg)	18221	5,295.00
50,000 lb	(22,679.6 kg)	18222	11,595.00
75,000 lb	(34,019.5 kg)	25354	11,595.00
<b>4-Module Kit</b>			
1000 lb	(453.6 kg)	18224	4,595.00
1500 lb	(680.4 kg)	18225	4,595.00
2500 lb	(1134.0 kg)	18227	4,595.00
5000 lb	(2268.0 kg)	18228	4,595.00
10,000 lb	(4535.9 kg)	18229	6,995.00
15,000 lb	(6803.9 kg)	18230	6,995.00
20,000 lb	(9071.9 kg)	18231	6,995.00
25,000 lb	(11,339.8 kg)	18232	6,995.00
50,000 lb	(22,679.6 kg)	18233	15,295.00
75,000 lb	(34,019.5 kg)	25355	15,295.00
<b>Dummy Load Cells (Mild Steel)</b>			
1000-5000 lb	(453.6-2268.0 kg)	18236	20.00
10,000-25,000 lb	(4535.9-11,339.8 kg)	18237	35.00
50,000 lb	(22,679.6 kg)	18238	50.00
<b>Equalizer Pads</b>			
1000 lb-5000 lb	—	Consult	
10,000 lb-25,000 lb	—	Consult	

## Shims, Stainless

	PART #	PRICE
<b>1K-5K</b>		
0.0625	150852	\$3.25
0.125	150853	8.50
0.250	150854	14.25
<b>10K-25K</b>		
0.0625	150855	12.75
0.125	150856	20.50
0.250	150857	57.00
<b>50K-75K</b>		
0.0625	150858	16.25
0.125	150859	26.25
0.250	150861	72.25

WEIGH MODULES

www.ricelake.com | Phone: 800-472-6703

RICE LAKE

# MVS Mount/MVS

Conversion Kit



*Picture is a representation of actual product*

Designed for the Rice Lake Weighing Systems SURVIVOR® Truck Scale product line, the MVS can also be purchased independently to support existing designs or applications. Built to withstand the punishment of the most severe environments, the MVS utilizes the center-loaded double-ended shear beam load cell design. The mount is self-centering, which eliminates the need of costly check rods. This results in a pendulum suspension effect that eliminates binding, protects the load cells from damaging side load common on truck scales and automatically returns the mount to dead center. The mount is easy to install and promises high performance and long life.

## Complete Kit Includes

- 4 to 10 RL75058-75,000 lb load cells with 35 ft or 60 ft cables
- 4 to 10 MVS mounts
- JB 8SPT junction box (JB1010 on 10 module kit)
- 100 ft of our Hostile Environment EL147HE SURVIVOR® load cell cable

## Applications

- Truck/Track scale conversion
- Heavy-capacity horizontal tanks

## Standard Features

- Capacity Design: 10,000-125,000 lb (4536.0-34,019.4 kg)
- Mild steel construction
- Specially hardened center link
- Self-checking design
- Self-centering design
- Accommodates thermal expansion and contraction

## Optional Features

- Vishay Sensortronics 65058 or Vishay Celtron CLB

*NOTE: Check with your local weights and measure officials for suitability in Legal for Trade applications.*

## Load Cell Certifications



# MVS Mount/MVS

Conversion Kit

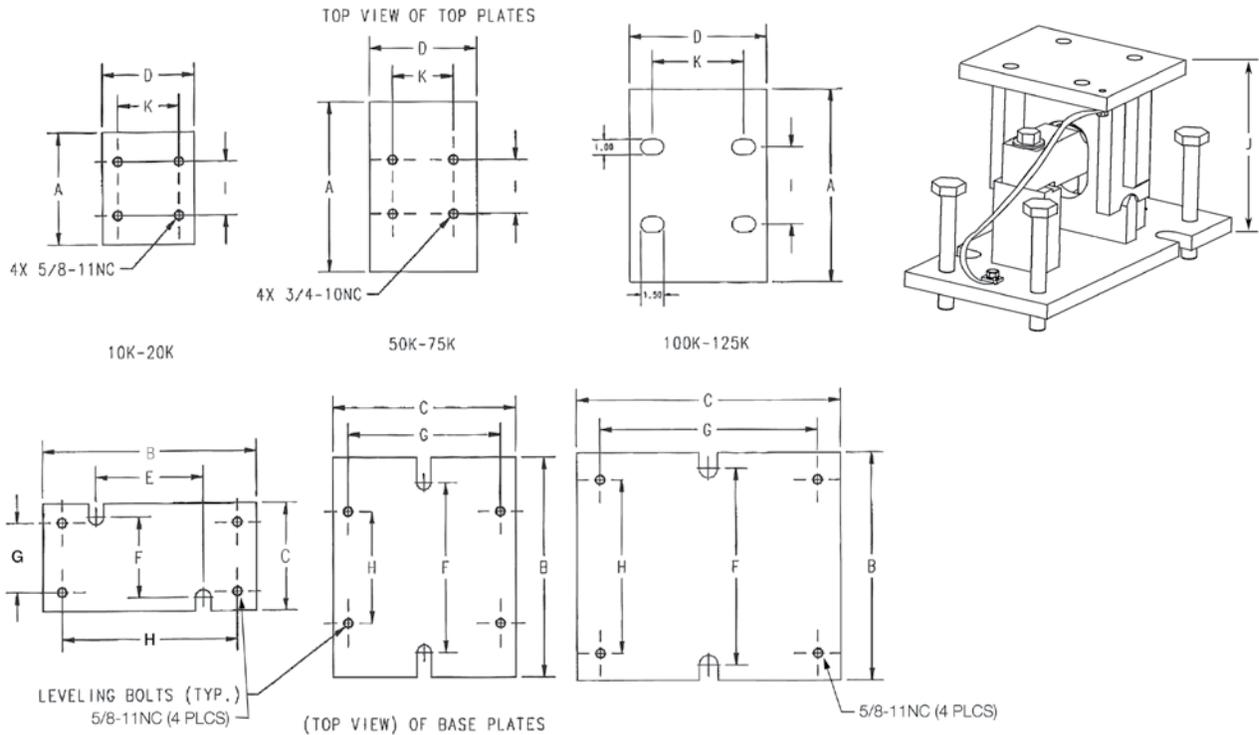

## Dimensions

RATED CAPACITY	A	B	C	D	E	F	G	H	I	J	K
<b>lb/inches</b>											
10,000-25,000	7.25	14.00	7.00	6.00	7.00	5.25	4.50	11.50	3.50	8.50	4.00
50,000-75,000	11.00	14.25	12.00	7.00	—	11.00	10.00	7.25	3.50	11.53	4.00
100,000-125,000	12.50	14.75	17.25	9.00	—	12.75	14.25	11.25	5.00	14.21	6.00
<b>kg/mm</b>											
4536-11,340	184.2	355.6	177.8	152.4	177.8	133.5	114.3	292.1	88.9	215.9	101.6
22,679.6-34,019.4	279.4	362.0	304.8	177.8	—	279.4	254	184.15	88.9	292.9	101.6
45,360-56,700	317.50	374.7	438.2	228.6	—	323.9	362.0	285.8	127.0	360.9	152.4

## Order Information

LOAD RATING (PER MODULE)	PART #	PRICE
<b>MVS Mount (Does NOT Include Load Cell)</b>		
10,000 lb-25,000 lb (4536-11,340 kg)	71200	\$595.00
50,000 lb-75,000 lb (22,679.6-34,019.4 kg)	46441	695.00
100,000 lb-125,000 lb (45,360 kg-56,700.0 kg)	68520	1,200.00

Custom heights available; Consult

\* Consult for other capacity requirements

## Order Information

LOAD RATING (PER MODULE)	PART #	PRICE
<b>MVS Conversion Kits (Includes 75,000 lb* Load Cells, Mounts and J-Box)</b>		
4-module kit	68495	\$6,595.00
6-module kit	68496	9,695.00
8-module kit	68497	13,195.00
10-module kit	68498	16,995.00

# TSA Truck Scale Assembly

Rice Lake Weighing Systems

## Applications

- Truck, track, horizontal tank or general purpose
- Light-duty livestock to heavy-duty vehicle scales

## Standard Features

- Capacities: 10,000-75,000 lb (4535.9-34,019.4 kg)
- Constructed of cast steel and iron with primer coating
- Unique high-performance “Unilink” suspension system
- Center-loaded double-ended shear beam design
- Self-checking design
- Rubber pad provided for mounting

## Optional Features

- 20,000-75,000 lb (9071.9-34,019.4 kg) capacity NTEP Certified load cells available for 1:10,000d, Class III

*NOTE: Check with your local weights and measure officials for suitability in Legal for Trade applications.*



*Mount only; does not include load cell*

*Picture is a representation of actual product*

The TSA truck scale assembly is designed for use with Rice Lake Weighing Systems RL75058 or Vishay Sensortronics 65058. The “Unilink” suspension design checks lateral movement of the assembly, while controlled floating of the scale deck is allowed. The effective integration of the TSA mount and the double-ended shear beam load cell eliminates the need for troublesome check rods, links, expansion assemblies and other peripheral hardware.

# TSA Truck Scale Assembly

Rice Lake Weighing Systems

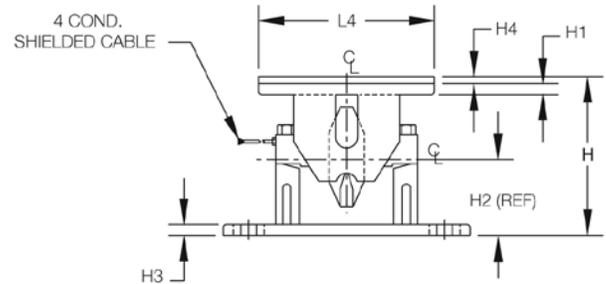
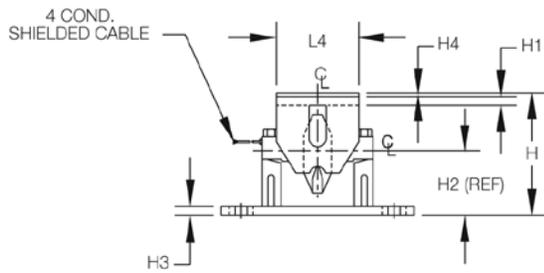
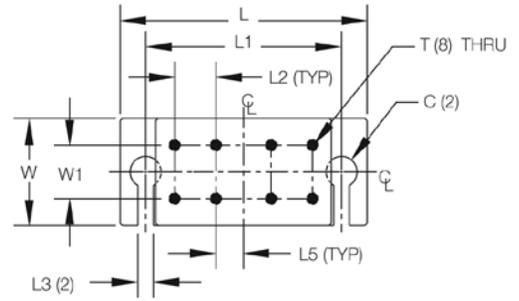
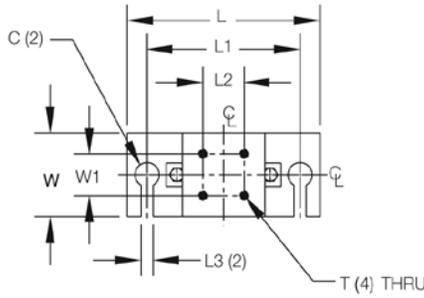

## Dimensions

RATED CAPACITY	C	H	H1	H2	H3	H4	L	L1	L2	L3	L4	L5	T	W	W1
<b>lb/inches</b>															
10,000-25,000	1.75 DIA.	8.75	.62	4.62	.62	.25	14.00	11.00	3.00	.88	6.00	—	5/8-11 UNC-2B	6.00	3.00
50,000-75,000	2.00 DIA.	11.00	.75	5.44	.75	.50	18.00	14.00	3.00	.88	12.75	2.00	3/4-10 UNC-2B	7.00	3.50
<b>kg/mm</b>															
4535.9-11,339.8	44.5 DIA.	222.3	15.7	117.3	15.7	6.4	355.6	279.4	76.2	22.4	152.4	—	5/8-11 UNC-2B	152.4	76.2
22,679.6-34,019.4	50.8 DIA.	279.4	19.1	138.2	19.1	12.7	457.2	355.6	76.2	22.4	323.9	50.8	3/4-10 UNC-2B	177.8	88.9

## Order Information

LOAD RATING (PER MODULE)	PART #	PRICE
10,000-20,000-25,000 lb (4535.9-9071.9-11,339.8 kg)	17821	\$1,195.00
50,000-60,000-75,000 lb (22,679.6-27,215.5-34,019.4 kg)	17822	1,395.00

\*Mount only; does not include load cell

See Vishay Sensortronics load cell model 65058 specifications

See Rice Lake Weighing Systems load cell model RL75058 specifications

See Rice Lake Weighing Systems welded-seal RL75060S specifications

# Translink™ Parallel Link Truck Scale Assembly

Rice Lake Weighing Systems

## Applications

- Truck scale mount
- Heavy-capacity horizontal tanks

## Standard Features

- Capacities: 25,000-100,000 lb (11,339.8-45,359.4 kg)
- Center-supported, end-loaded double-ended shear beam design
- Free movement in all directions in the horizontal plane with virtually no friction
- Links provide optimal loading conditions for the cell
- Completely self-centering
- Requires no check rods
- Utilizes cells with 3mV/V output
- Models available are RL75223 and RL75040, RTI 5223 and Vishay Sensortronics 65040A load cells

*NOTE: Check with your local weights and measure officials for suitability in Legal for Trade applications.*



*Mount only; does not include load cell*

*Picture is a representation of actual product*

The TRANSLINK parallel link truck scale assembly is designed for use with Rice Lake Weighing Systems' RL75223 and RL75040A, Revere Transducers 5223 or VPG Sensortronics' 65040A load cells. This design allows the scale platform to move freely in all directions in a horizontal plane while causing the platform to self-center because of the pendulous action of the links. The unique parallel link design eliminates the need for costly and troublesome checkrods. Simply install platform bumpers and forget about over-travel. This mount is ideal for heavy-capacity weigh bridges.



# Translink™ Parallel Link Truck Scale Assembly

Rice Lake Weighing Systems

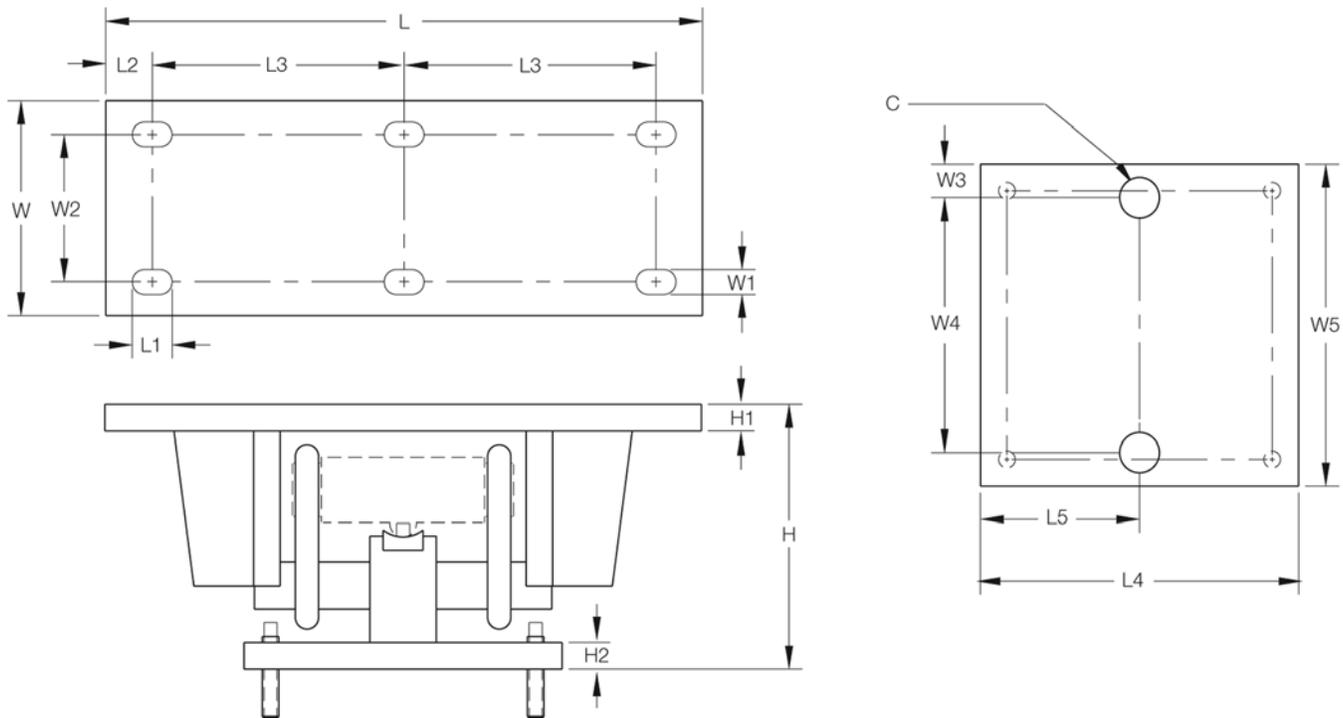

## Dimensions

RATED CAPACITY	C	H	H1	H2	L	L1	L2	L3	L4	L5	W	W1	W2	W3	W4	W5
<b>lb/inches</b>																
50,000-100,000 (RL75223, 5223)	1.50	12.93	1.00	1.00	22.50	1.50	1.75	9.50	11.75	5.88	7.75	.91	5.25	1.25	9.25	11.75
25,000-40,000 (RL75040A, 65040A)	1.50	9.88	1.00	1.00	18.50	1.50	1.75	7.50	11.75	5.88	7.75	.91	5.25	1.25	9.25	11.75
50,000-75,000 (RL75040A, 65040A)	1.50	12.82	1.00	1.00	22.50	1.50	1.75	9.50	11.75	5.88	7.75	.91	5.25	1.25	9.25	11.75
<b>kg/mm</b>																
22,679.6-45,359.4	38.1	328.4	25.4	25.4	571.5	37.5	44.5	241.3	298.5	149.4	196.9	23.1	133.4	31.8	235.0	298.4
11,339.8-18,143.7	38.1	251.0	25.4	25.4	469.9	37.5	44.5	190.5	298.5	149.4	196.9	23.1	133.4	31.8	235.0	298.4
22,679.6-34,019.4	38.1	325.6	25.4	25.4	571.5	37.5	44.5	241.3	298.5	149.4	196.9	23.1	133.4	31.8	235.0	298.4

## Order Information

LOAD RATING (PER MODULE)	PART #	PRICE
<b>For Use With RL75223, 5223 Load Cells</b>		
50,000-100,000 lb (22,679.6-45,359.4 kg)	17970	\$725.00
<b>For Use With RL75040A, 65040A Load Cells</b>		
25,000-40,000 lb (11,339.8-18,143.7 kg)	17971	725.00
50,000-75,000 lb (22,679.6-34,019.4 kg)	17972	725.00

\*Mount only; does not include load cell

See load cell model RL75223 (RLWS), load cell model RL75040 (RLWS) and model 65040A (Vishay Sensortronics) specifications

# Motor Truck Scale Electronic Conversion Kit

Rice Lake Weighing Systems



## Complete Kit Includes

- 1 JB8SP NEMA 4X signal-trim junction box with individual and section trimming capability (6 and 8-mount kits) or 1 JB4SP NEMA 4X signal-trim junction box (4-mount kits)
- 1 UJB3T6 DC transient protector
- 4, 6 or 8 Translink mounting assemblies with RL75040 or RL75223 load cells
- 100' of Hostile Environment EL147HE SURVIVOR® load cell cable

## Applications

- Updating existing mechanical motor truck scales
- Replacing unsatisfactory electronic motor truck scales
- Conversion of heavy-capacity scales into fully electronic vehicle scales where the existing scale cannot be removed

## Standard Features

- Cost-and time-efficient installation; no need to remove weighbridge
- Converts existing scale capacities of 40,000-300,000 lb (18,143.7-90,718.7 kg)
- 4, 6 or 8-mount kits for 2, 3 or 4-section conversions
- Translink™ heavy-capacity mounting assemblies
- Free movement in all directions in the horizontal plane with virtually no friction
- Completely self-centering
- Requires no check rods
- Capacity per mount: 25,000-100,000 lb (11,339.8-45,359.4 kg)
- Utilizes cells with 3 mV/V output

## Optional Features

- Custom heights available; Consult
- RLWS RL75223 welded-seal, Vishay Sensortronics 65040A or RTI 5223 load cells

*NOTE: Check with your local weights and measure officials for suitability in Legal for Trade applications.*

*Picture is a representation of actual product*

Full electronic performance can be achieved at a fraction of the cost of a new scale and pit. The Motor Truck Scale (MTS) Electronic Conversion Kit is designed to transform an existing scale pit and weighbridge into a fully electronic vehicle scale. Designed for quick installation without removing the platform or reconfiguring the pit, the conversion kit can often be installed in a matter of days, minimizing downtime. This ease of installation is important when considering installations where it is not feasible to completely remove the existing scale.

# Motor Truck Scale Electronic Conversion Kit

Rice Lake Weighing Systems

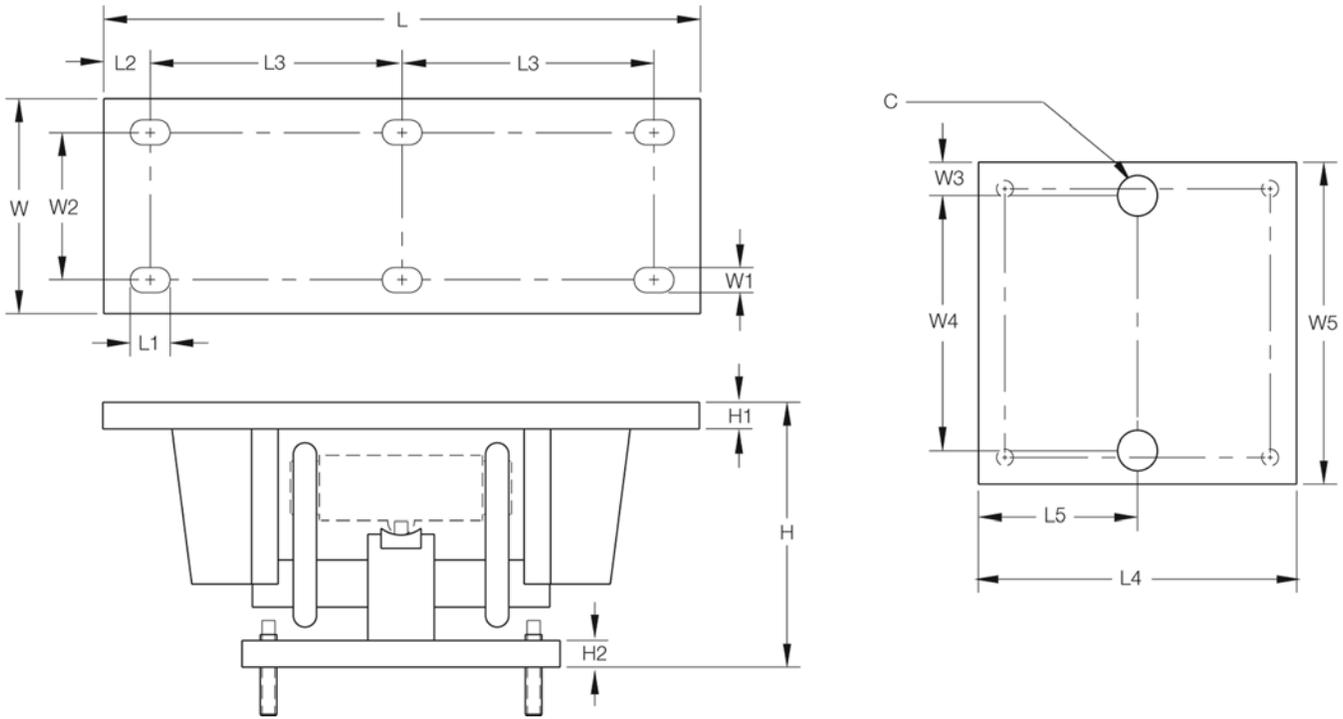

## Dimensions

RATED CAPACITY	C	H*	H1	H2	L	L1	L2	L3	L4	L5	W	W1	W2	W3	W4**	W5
<b>lb/inches</b>																
50,000-100,000 (RL75223)	1.50	12.93	1.00	1.00	22.50	1.50	1.75	9.50	11.75	5.88	7.75	.91	5.25	1.25	9.25	11.75
25,000-40,000 (RL75040A)	1.50	9.88	1.00	1.00	18.50	1.50	1.75	7.50	11.75	5.88	7.75	.91	5.25	1.25	9.25	11.75
50,000-75,000 (RL75040A)	1.50	12.82	1.00	1.00	22.50	1.50	1.75	9.50	11.75	5.88	7.75	.91	5.25	1.25	9.25	11.75
<b>kg/mm</b>																
22,679.6-45,400.00 (RL75223)	38.1	328.4	25.4	25.4	571.5	37.5	44.5	241.3	298.5	149.4	196.9	23.1	133.4	31.8	235.0	298.45
11,339.8-18,143.7 (RL75040A)	38.1	251.0	25.4	25.4	469.9	37.5	44.5	190.5	298.5	149.4	196.9	23.1	133.4	31.8	235.0	298.45
22,679.6-34,019.4 (RL75040A)	38.1	325.6	25.4	25.4	571.5	37.5	44.5	241.3	298.5	149.4	196.9	23.1	133.4	31.8	235.0	298.45

\*Custom heights available; Consult

\*\*Custom hole spacing for existing bolt patterns is available; Consult

## Order Information

SCALE SUGGESTED CAPACITY	LOAD CELL CAPACITY (PER MODULE)	PART #	PRICE	LOAD CELL USED IN KIT
<b>4-Module Kit (Includes Weigh Modules Load Cells, J-Box, and Transient Protection)</b>				
40,000 lb (18,143.7 kg)	25,000 lb (11,339.8 kg)	30513	\$5,525.00	RL75040A
60,000 lb (27,215.6 kg)	40,000 lb (18,143.7 kg)	30514	6,025.00	RL75040A
<b>6-Module Kit (Includes Weigh Modules Load Cells, J-Box, and Transient Protection)</b>				
100,000 lb (45,359.4 kg)	50,000 lb (22,679.6 kg)	30515	9,495.00	RL75040A
120,000 lb (54,431.2 kg)	60,000 lb (27,215.6 kg)	30516	9,495.00	RL75040A
<b>8-Module Kit (Includes Weigh Modules Load Cells, J-Box, and Transient Protection)</b>				
120,000 lb (54,431.2 kg)	60,000 lb (27,215.6 kg)	30517	12,225.00	RL75040A
200,000 lb (90,718.7 kg)	75,000 lb (34,019.4 kg)	30518	12,225.00	RL75040A
300,000 lb (SD 136,078.1 kg)	100,000 lb (45,359.4 kg)	30512	14,950.00	RL75223

SD refers to super duty, 100,000 lb (45,359.4 kg) capacity welded-seal load cells

# MagnaMount®

Tank, Truck and Railroad Track Assembly

## Applications

- Truck scale mount\*
- Heavy-capacity horizontal tanks\*
- Railroad track mount\*

## Standard Features

- Capacities: 50,000, 100,000 and 200,000 lb (22,679.6, 45,359.4 and 90,718.7 kg)
- Protects load cell from shock and side loads
- Low-profile design
- High-strength load bearing plate made of high-grade carbon steel hardened to Rockwell C 48-54
- PTFE-coated shock absorbing pads
- Compatible with Revere Transducers CP and CSP and Rice Lake Weighing Systems' RLCSP1 NTEP Certified load cells

*\*Check rods required*

*NOTE: Check with your local weights and measure officials for suitability in Legal for Trade applications.*



*Mount only; does not include load cell*

*Picture is a representation of actual product*

The MagnaMount Tank, Truck and Railroad scale assembly is designed for use with Rice Lake Weighing Systems RLCSP1 or Revere Transducers CP or CSP load cells. The “Shielded Cell” load cell mounting assembly is a highly reliable design that shields the load cell from shock and side load effects, assuring accurate weighing even under adverse loading conditions.

# MagnaMount®

Tank, Truck and Railroad Track Assembly

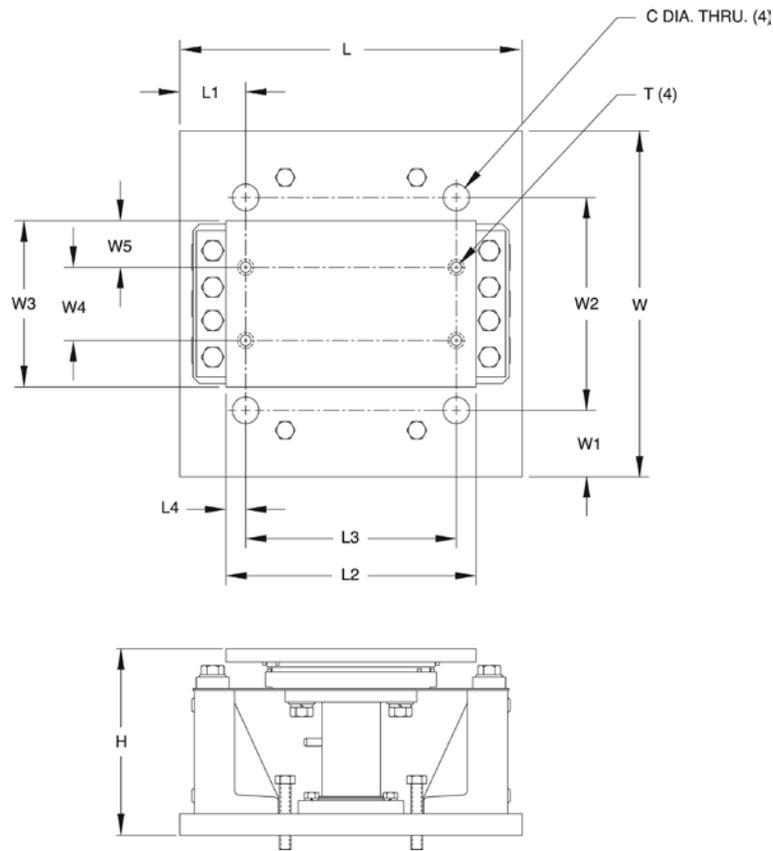

## Dimensions

RATED CAPACITY	C	H	L	L1	L2	L3	L4	T	W	W1	W2	W3	W4	W5
<b>lb/inches</b>														
50,000	1.25	7.39	13.00	1.75	11.25	8.50	1.37	3/4-10 UNC	12.00	1.75	8.50	8.00	4.50	1.75
100,000	1.50	11.29	20.00	2.50	18.00	15.50	1.25	7/8-9 UNC	17.00	2.50	12.00	9.00	5.50	1.75
200,000	2.00	14.10	26.00	5.00	19.00	16.00	1.50	1-8 UNC	26.00	5.00	16.00	12.50	5.50	3.50
<b>kg/mm</b>														
22,679.6	31.8	187.7	330.2	44.5	285.8	241.3	34.8	3/4-10 UNC	304.8	44.5	215.9	203.2	114.3	44.5
45,359.4	38.1	286.8	508.0	63.5	457.2	393.7	31.8	7/8-9 UNC	431.8	63.5	304.8	228.6	139.7	44.5
90,718.7	50.8	358.1	660.4	127.0	482.6	406.4	38.1	1-8 UNC	660.4	127.0	406.4	317.5	139.7	88.9

## Order Information

LOAD RATING (PER MODULE)	PART #	PRICE
50,000 lb (22,679.6 kg)	21723	\$1,295.00
100,000 lb (45,359.4 kg)	21724	1,595.00
200,000 lb (90,718.7 kg)	17974	2,395.00

\*Mount only; does not include load cell

See Revere Transducers load cell model CP, and CSP for NTEP Certified load cell model specifications

See Rice Lake Weighing Systems' NTEP Certified load cell model RLCSP1

# Mettler Toledo™ DigiTOL® Retrofit Kit

Stainless Steel, Rice Lake Weighing Systems/Flintec



Shown here with the JB8SP signal trim junction box

Picture is a representation of actual product

These kits are designed to provide a cost effective solution for replacing Toledo™ DigiTOL® digital load cells with analog load cells. The Flintec RC1 and RC3 load cells are stainless steel and hermetically sealed to provide years of trouble-free service.

## Load Cell Certifications

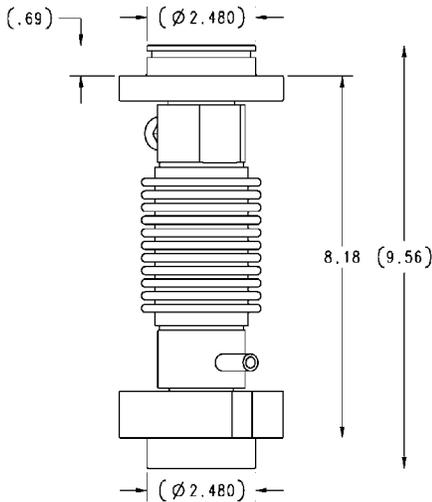

RC1-250KN

## Complete Kit Includes

- 1 JB8SP or 2 JB8SP signal trim junction boxes (8 and 10 mount kit)
- 3 EL304 signal trim boxes in 12 mount kits
- 8, 10 or 12 Flintec RC1-250 KN load cells with upper and lower load cups
- 100ft of Hostile Environment EL147HE SURVIVOR® load cell cable
- Cups included

## Applications

- Toledo DigiTOL truck scale conversion

## Standard Features

- Stainless steel hermetically sealed load cells
- Converts existing Mettler Toledo DigiTOL scale to an analog based load cell weighing system
- 8, 10 or 12 load cells, cups plus J-box and homerun cable
- Load cells are NTEP Certified 1:10,000 divisions, Class III L\*
- Rocker design load cells
- Load cups

## DigiTOL Retrofit Order information

DESCRIPTION	PART #	PRICE
8 mount kit. (RC1-56K)	78713	\$8,795.00
10 mount kit. (RC1-56K)	78714	10,695.00
12 mount kit (RC1-56K)	152774	13,195.00

\*Consult your local Weights and Measures Authorities for local Legal for Trade requirements

# Mettler Toledo™ DigiTOL® Retrofit Kit

Stainless Steel, Rice Lake Weighing Systems/Flintec



Shown here with the JB8SP signal trim junction box

Picture is a representation of actual product

This kit is designed to provide a cost effective solution for replacing Toledo™ DigiTOL® digital load cells with analog load cells. The Flintec RC3 load cell is stainless steel and hermetically sealed to provide years of trouble-free service.

## Load Cell Certifications

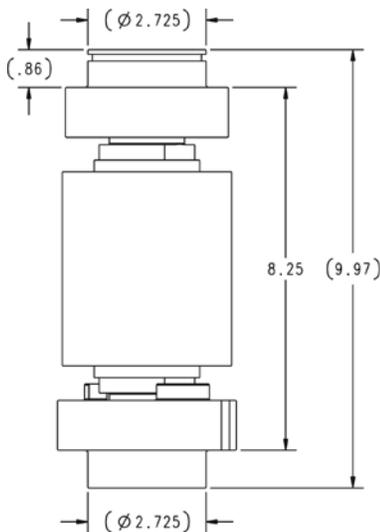

RC3-50t

## Complete Kit Includes

- 1 JB8SP or 2 JB8SP signal trim junction boxes (8 and 10 mount kit)
- 3 EL304 signal trim boxes in 12 mount kits
- 8, 10 or 12 Flintec RC3
- 100 ft of Hostile Environment EL147HE SURVIVOR® load cell cable
- Cups included

## Applications

- Toledo DigiTOL truck scale conversion

## Standard Features

- Stainless steel hermetically sealed load cells
- Converts existing Mettler Toledo DigiTOL scale to an analog based load cell weighing system
- 8 or 10 load cells, cups plus J-box and homerun cable
- Load cells are NTEP Certified 1:10,000 divisions, Class III\*
- Rocker design load cells
- Load cups

## DigiTOL Retrofit Order information

DESCRIPTION	PART #	PRICE
8 mount kit (RC3-50T) RR/track	129844	\$11,995.00
8 mount (RC3-50T) truck	154347	11,995.00
10 mount kit (RC3-50T) RR/track	111367	14,795.00
10 mount kit (RC3-50T) truck	154348	14,795.00
12 mount kit (RC3-50T) truck	154349	17,185.00

\*Consult your local Weights and Measures Authorities for local Legal for Trade requirements

# Electronic Floor Scale Underdeck Kits



## Alloy Steel Load Cells

### INDUSTRIAL APPLICATIONS

#### Kit Includes

- (4) Vishay Celtron SQB load cells
- (1) JB4SS stainless steel NEMA 4X junction box
- (4) Surefoot high-accuracy stainless steel support feet
- 20 ft/6.1 m EL147HE load cell cable
- (4) Mounting plates and (8) Load cell bolts

## Order Information

LOAD CELL/BASE CAPACITY	PART #	PRICE
<b>Kit Includes Vishay Celtron SQB Load Cells</b>		
1000 lb for 2000 lb base (453.6 kg for 907.2 kg base)	26436	\$895.00
2500 lb for 5000 lb base (1134.0 kg for 2268.0 kg base)	26437	895.00
4000 lb for 10,000 lb base (1814.4 kg for 4535.9 kg base)	26438	895.00

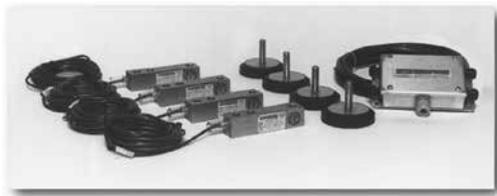

## Alloy Steel NTEP Certified Load Cells

### HIGH-PRECISION APPLICATIONS

#### Kit Includes

- (4) RL35023 alloy steel NTEP 5000 Divisions, Class III certified load cells
- (1) JB4SS stainless steel NEMA 4X junction box
- (4) Surefoot high-accuracy stainless steel support feet
- 20 ft/6.1 m EL147HE load cell cable
- (4) Mounting plates and (8) Load cell bolts

NOTES: For complete load cell specifications, see RL35023.

The use of NTEP Certified load cells in a scale base does not constitute approval of the completed base. Consult with local or state jurisdiction for compliance requirements.

## Order Information

LOAD CELL/BASE CAPACITY (PER MODULE)	PART #	PRICE
<b>Kit Includes RL35023 Alloy Steel NTEP Certified Load Cells</b>		
1000 lb for 2000 lb base (453.6 kg for 907.2 kg base)	19032	\$975.00
2500 lb for 5000 lb base (1134.0 kg for 2268.0 kg base)	19033	975.00
4000 lb for 10,000 lb base (1814.4 kg for 4535.9 kg base)	19034	975.00

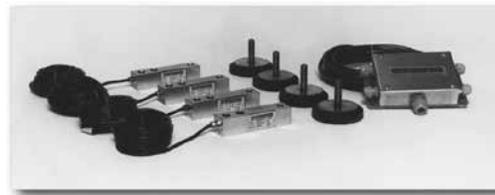

## Stainless Steel Load Cells

### CHEMICAL, DRY CORROSIVE AND NON-WASHDOWN APPLICATIONS

#### Kit Includes

- (4) Vishay Celtron SQB-HSS stainless steel load cells
- (1) JB4SS stainless steel NEMA 4X junction box
- (4) Surefoot high-accuracy stainless steel support feet
- 20 ft/6.1 m EL147HE load cell cable
- (4) Mounting plates and (8) Load cell bolts

NOTE: For complete load cell specifications, see SQB-HSS.

## Order Information

LOAD CELL/BASE CAPACITY	PART #	PRICE
<b>Kit Includes Vishay Celtron SQB-HSS Stainless Steel Load Cells</b>		
1000 lb for 2000 lb base (453.6 kg for 907.2 kg base)	19035	\$1,275.00
2500 lb for 5000 lb base (1134.0 kg for 2268.0 kg base)	19036	1,275.00
4000 lb for 10,000 lb base (1814.4 kg for 4535.9 kg base)	19037	1,275.00

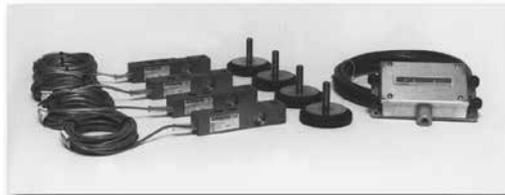

## Welded Seal Stainless Steel Load Cells

### WET CORROSIVE APPLICATIONS

#### Kit Includes

- (4) RL35083 welded-seal stainless steel load cells
- (1) JB4SS stainless steel NEMA 4X junction box
- (4) Surefoot high-accuracy stainless steel support feet
- 20 ft/6.1 m EL147HE load cell cable
- (4) Mounting plates and (8) Load cell bolts

NOTE: For complete load cell specifications, see RL35083.

## Order Information

LOAD CELL/BASE CAPACITY (PER MODULE)	PART #	PRICE
<b>Kit Includes RL35083 Welded-Seal Load Cells</b>		
1000 lb for 2000 lb base (453.6 kg for 907.2 kg base)	19038	\$1,595.00
2500 lb for 5000 lb base (1134.0 kg for 2268.0 kg base)	19039	1,595.00
4000 lb for 10,000 lb base (1814.4 kg for 4535.9 kg base)	19040	1,595.00

Scale "Underdeck" Kits are provided to meet the application needs of the electronic floor scale producer and are an easy source for rebuilding existing floor scales. Underdeck kits are provided with mounting plates and load cell bolts for easy installation.



# RL20000

S-Beam, Alloy Steel, NTEP 1:5000 III/1:10,000 IIIL



Picture is a representation of actual product

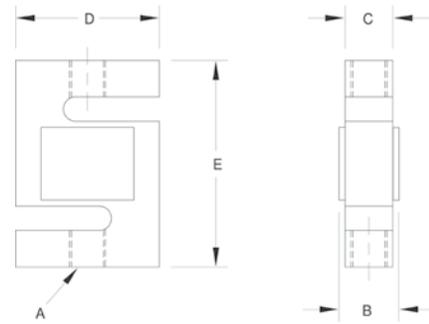

## Specifications

**Full Scale Output:**

3.0mV/V

**Output Resistance:**

350 ohms, +/- 3

**Input Resistance:**

385 ohms, +/- 5

**Material/Finish:**

High-alloy steel, nickel plated

**Temperature:**

Compensated range  
14°F to 104°F/-10°C to 40°C

**Seal Type:**

Environmentally sealed, IP67

**Safe Overload:**

150% Full scale

**Rated Excitation:**

10V DC (15V maximum)

**Combined Error:**

0.02%

**Insulation Resistance:**

5000 megohms

**Cable Length:**

20 ft/6.1 m

**Cable Diameter:**

.200 polyurethane jacket

**Cable Color Code:**

Red .....+ Excitation  
Black.....- Excitation  
Green .....+ Signal  
White .....- Signal

**Warranty:**

Two-year limited warranty

**Approvals:**



## Dimensions

RATED CAPACITY	A	B	C	D	E
<b>lb/inches</b>					
25-300	1/4-28 UNF-2B	.75	.50	2.00	2.50
500-1500	1/2-20 UNF-2B	1.00	.75	2.00	2.50
2000-2500	1/2-20 UNF-2B	1.25	1.00	2.00	2.50
3000	1/2-20 UNF-2B	1.25	1.00	3.00	4.00
5000-10,000	3/4-16 UNF-2B	1.25	1.00	3.00	4.00
15,000	1-12 UNF-2B	1.50	1.25	4.00	5.50
20,000	1 1/4-12 UNF-2B	2.25	2.00	5.00	7.00
<b>kg/mm</b>					
11.3-136.1	1/4-28 UNF-2B	19.1	12.7	50.8	63.5
226.8-680.4	1/2-20 UNF-2B	25.4	19.1	50.8	63.5
907.2-1134.0	1/2-20 UNF-2B	31.8	25.4	50.8	63.5
1360.8	1/2-20 UNF-2B	31.8	25.4	76.2	101.6
2268.0-4535.9	3/4-16 UNF-2B	31.8	25.4	76.2	101.6
6803.9	1-12 UNF-2B	38.1	31.8	101.6	139.7
9071.9	1 1/4-12 UNF-2B	57.2	50.8	127.0	177.8

# RL20000

S-Beam, Alloy Steel, NTEP 1:5000 III/1:10,000 IIIL

## Order Information

LOAD RATING		PART #	PRICE
25 lb	(11.3 kg)	21428	\$275.00
50 lb	(22.7 kg)	21429	275.00
75 lb	(34.0 kg)	21430	275.00
100 lb	(45.4 kg)	21431	275.00
150 lb	(68.0 kg)	21432	275.00
200 lb	(90.7 kg)	21433	275.00
250 lb	(113.4 kg)	21434	275.00
300 lb	(136.1 kg)	21435	275.00
500 lb	(226.8 kg)	21436	275.00
750 lb	(340.2 kg)	21437	275.00
1000 lb	(453.6 kg)	21438	275.00
1500 lb	(680.4 kg)	21439	275.00
2000 lb***	35 ft Cable	21356	338.00
2000 lb	(907.2 kg)	21440	275.00
2500 lb	(1134.0 kg)	21441	275.00
3000 lb	(1360.8 kg)	21442	315.00
5000 lb***	30 ft Cable	17044	476.00
5000 lb	(2268.0 kg)	21443	440.00
10,000 lb	(4535.9 kg)	21444	440.00
15,000 lb	(6803.9 kg)	21445	555.00
20,000 lb***	30 ft Cable	17045	937.00
20,000 lb	(9071.9 kg)	21446	875.00
<b>Conduit Adapter Kit*(must be factory installed to maintain warranty)</b>			
3/8-24 Nipple		31533*	30.00
3/8-24 to 1/4-18NPT		31534*	30.00

\* Parts #31533 and #31534 must be installed together to form the Conduit Adapter Kit

\*\*\*These load cells have 30' of cable and trimmed outputs and are used in many batch plants

## Interchangeable Products

MANUFACTURER	MODEL
**Artech®	20210 (15K has 1 in.-14)

\*\*Except 15K

## Weigh Module Available

MANUFACTURER	MODEL
Rice Lake Weighing Systems	ITCM Isolated Tension Cell Mount

# RL20000 SS

S-Beam, Stainless Steel, NTEP 1:10,000 Class IIIIL Single Cell



Picture is a representation of actual product

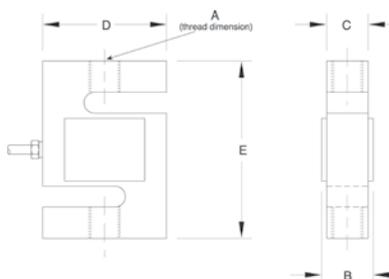

## Specifications

**Full Scale Output:**  
3.0 mV/V (+/- .008)

**Output Resistance:**  
350 ohms, +/- 3.5

**Input Resistance:**  
390 ohms, +/- 15

**Material/Finish:**  
Stainless steel

**Temperature:**  
Compensated range 14°F to 104°F/  
-10°C to 40°C

**Seal Type:**  
Environmentally sealed, IP67

**Safe Overload:**  
150% Full scale

**Rated Excitation:**  
10V DC (15V maximum)

**Nonlinearity:**  
0.03% Full scale

**Hysteresis:**  
0.02% Full scale

**Insulation Resistance:**  
5000 megohms

**Cable Length:**  
20 ft/6.1 m

**Cable Color Code:**  
Red .....+ Excitation  
Black.....- Excitation  
Green .....+ Signal  
White .....- Signal

**Warranty:**  
Two-year limited warranty

**Approvals:**



## Dimensions

RATED CAPACITY	A	B	C	D	E
<b>lb/inches</b>					
50-250	1/4-28 UNF-2B	.65	.46	2.00	2.40
500-1000	1/2-20 UNF-2B	.90	.71	2.00	2.40
2500	1/2-20 UNF-2B	1.15	.96	2.00	2.40
3000	1/2-20 UNF-2B	1.15	.96	3.00	3.90
5000	3/4-16 UNF-2B	1.15	.96	3.00	3.90
10,000	3/4-16 UNF-2B	1.15	1.21	3.00	3.90
15,000	1-14 UNS-2B	1.63	1.46	3.44	5.50
20,000	1 1/4-12 UNF-2B	1.88	1.68	4.44	7.00
<b>kg/mm</b>					
22.7-113.4	1/4-28 UNF-2B	16.5	11.7	50.8	61.0
226.8-453.6	1/2-20 UNF-2B	22.9	18.0	50.8	61.0
1134.0	1/2-20 UNF-2B	29.2	24.4	50.8	61.0
1360.8	1/2-20 UNF-2B	29.2	24.4	76.2	99.1
2268.0	3/4-16 UNF-2B	29.2	24.4	76.2	99.1
4535.9	3/4-16 UNF-2B	29.2	30.7	76.2	99.1
15,000	1-14 UNS-2B	41.4	37.1	87.4	139.7
20,000	1 1/4-12 UNF-2B	47.8	42.8	112.8	177.8

## RL20000 SS

Stainless Steel, NTEP 1:10,000 Class III Single Cell

### Order Information

LOAD RATING		PART #	PRICE
<b>RL20000 SS NTEP</b>			
100 lb	(45.4 kg)	46511	\$295.00
250 lb	(113.4 kg)	46503	295.00
500 lb	(226.8 kg)	46504	295.00
750 lb	(340.2 kg)	46505	295.00
1000 lb	(453.6 kg)	46506	295.00
2500 lb	(1134.0 kg)	46507	295.00
3000 lb	(1360.8 kg)	46508	325.00
5000 lb	(2268.0 kg)	46509	475.00
10,000 lb	(4535.9 kg)	46510	495.00
<b>RL20000 SS NON-NTEP</b>			
50 lb	(22.9 kg)	17013	295.00
15,000 lb	(6804.0 kg)	158375	675.00
20,000 lb	(9072.0 kg)	158376	895.00
<b>Conduit Adapter Kit*(must be factory installed to maintain warranty)</b>			
3/8-24 Nipple		31533*	30.00
3/8-24 to 1/4-18NPT		31534*	30.00

\* Parts #31533 and #31534 must be installed together to form the Conduit Adapter Kit

### Interchangeable Products

MANUFACTURER	MODEL
VPG Revere Transducers	9363
Artech®	SS20210

### Weigh Module Available

MANUFACTURER	MODEL
Rice Lake Weighing Systems	ITCM Isolated Tension Cell Mount

# RL20000 ST

S-Beam, Stainless Steel, NTEP 1:10,000 Class III L Single Cell, IP67



Picture is a representation of actual product

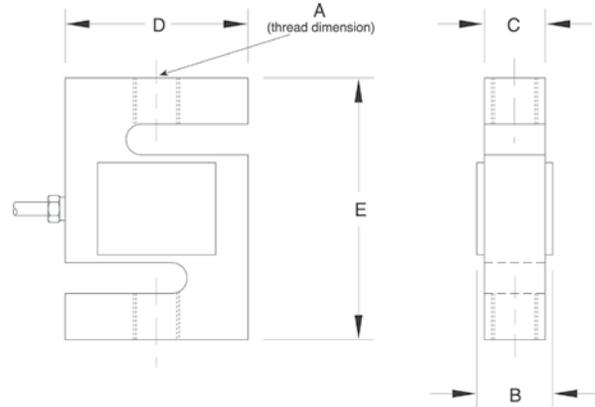

## Specifications

<b>Full Scale Output:</b> 3.0 mV/V <b>Output Resistance:</b> 350 ohms, +/- 3.5 <b>Input Resistance:</b> 430 ohms, +/- 60 <b>Material/Finish:</b> Stainless steel <b>Temperature:</b> Compensated range 14°F to 104°F/-10°C to 40°C	<b>Seal Type:</b> Environmentally sealed, IP67 <b>Safe Overload:</b> 150% Full scale <b>Rated Excitation:</b> 10V DC (15V maximum) <b>Nonlinearity:</b> 0.03% Full scale <b>Hysteresis:</b> 0.02% Full scale	<b>Insulation Resistance:</b> 5000 megohms <b>Cable Length:</b> 20 ft/6.1 m <b>Cable Diameter:</b> .190 polyurethane jacket <b>Cable Color Code:</b> Red .....+ Excitation Black.....- Excitation Green.....+ Signal White .....- Signal	<b>Warranty:</b> Two-year limited warranty <b>Approvals:</b>  
--	---	--	---

## Dimensions

RATED CAPACITY	A	B	C	D	E
<b>lb/inches</b>					
50-300	1/4-28 UNF-2B	.65	.46	2.00	2.40
500-1000	1/2-20 UNF-2B	.90	.71	2.00	2.40
1500-2500	1/2-20 UNF-2B	1.15	.96	2.00	2.40
3000	1/2-20 UNF-2B	1.15	.96	3.00	3.90
5000-10,000	3/4-16 UNF-2B	1.15	.96	3.00	3.90
15,000	1-14 UNF-2B	1.69	1.50	4.00	5.50
20,000	1 1/4-12 UNF-2B	2.19	2.00	5.00	7.00
<b>kg/mm</b>					
22.7-45.4	1/4-28 UNF-2B	16.5	11.7	50.8	60.9
340.2-453.6	1/2-20 UNF-2B	22.9	18.0	50.8	60.9
680.4-1134	1/2-20 UNF-2B	29.2	24.4	50.8	60.9
1360.8	1/2-20 UNF-2B	29.2	24.4	76.2	99.1
2268-4535.9	3/4-16 UNF-2B	29.2	24.4	76.2	99.1
6803.9	1-14 UNF-2B	42.9	38.1	101.6	139.7
9071.9	1 1/4-12 UNF-2B	55.6	50.8	127.0	177.8

## Order Information

LOAD RATING		PART #	PRICE
50 lb	(22.9 kg)	72741	\$295.00
100 lb	(45.4 kg)	72742	295.00
200 lb	(90.72 kg)	72743	295.00
250 lb	(113.4 kg)	72744	295.00
300 lb	(136.1 kg)	72745	295.00
500 lb	(226.8 kg)	72746	295.00
750 lb	(340.2 kg)	72747	295.00
1000 lb	(453.6 kg)	72748	295.00
1500 lb	(680.4 kg)	72749	295.00
2000 lb	(907.2 kg)	72750	295.00
2500 lb	(1134.0 kg)	72751	295.00

## Order Information

LOAD RATING		PART #	PRICE
3000 lb	(1360.8 kg)	72752	\$395.00
5000 lb	(2268.0 kg)	72753	495.00
10,000 lb	(4535.9 kg)	72754	695.00
15,000 lb	(6804.0 kg)	72755	995.00
20,000 lb	(9072.0 kg)	72756	1,295.00
<b>Conduit Adapter Kit*(must be factory installed to maintain warranty)</b>			
3/8-24 Nipple		31533*	30.00
3/8-24 to 1/4-18 NPT		31534*	30.00

\* Parts #31533 and #31534 must be installed together to form the Conduit Adapter Kit.  
Conduit Adapter Kit\* (must be factory installed to maintain warranty)

# RL20001

S-Beam, Alloy Steel, NTEP Single Cell, IP67 1:5000 III/1:10,000 IIIL



Picture is a representation of actual product

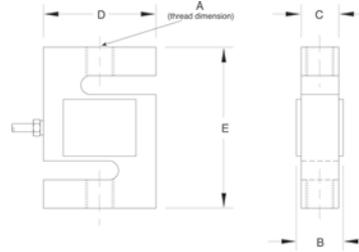

## Specifications

### Full Scale Output:

3.0mV/V

### Output Resistance:

350 ohms, +/- 3

### Input Resistance:

385 ohms, +/- 5

### Material/Finish:

High-alloy steel, nickel plated

### Temperature:

Compensated range  
14°F to 104°F/-10°C to 40°C

### Seal Type:

Environmentally sealed, IP67

### Safe Overload:

150% Full scale

### Rated Excitation:

10V AC/DC (15V max.)

### Nonlinearity:

0.03% Full scale

### Hysteresis:

0.02% Full scale

### Insulation Resistance:

5000 megohms

### Cable Length:

20 ft/6.1 m

### Cable Diameter:

200 polyurethane jacket

### Cable Color Code:

Red ..... + Excitation  
Black..... - Excitation  
Green ..... + Signal  
White ..... - Signal

### Warranty:

Two-year limited warranty

### Approvals:



## Dimensions

RATED CAPACITY	A	B	C	D	E
<b>lb/inches</b>					
250	3/8-24 UNF-2B	.75	.50	2.00	3.00
500-2000	1/2-20 UNF-2B	1.00	.75	2.00	3.00
2500-3000	1/2-20 UNF-2B	1.25	1.00	2.00	3.00
5000	3/4-16 UNF-2B	1.25	1.00	3.00	4.25
10,000	3/4-16 UNF-2B	1.25	1.00	3.50	4.75
15,000	1-14 UNF-2B	1.50	1.25	4.00	5.50
20,000	1 1/4-12 UNF-2B	2.25	2.00	5.00	7.00
<b>kg/mm</b>					
113.4	3/8-24 UNF-2B	19.1	12.7	50.8	76.2
226.8-907.2	1/2-20 UNF-2B	25.4	19.1	50.8	76.2
1134.0-1360.8	1/2-20 UNF-2B	31.8	25.4	50.8	76.2
2268.0	3/4-16 UNF-2B	31.8	25.4	76.2	108.8
4535.9	3/4-16 UNF-2B	31.8	25.4	88.9	120.7
6803.9	1-14 UNF-2B	38.1	31.8	101.6	139.7
9071.9	1 1/4-12 UNF-2B	57.2	50.8	127.0	177.8

## Order Information

LOAD RATING	PART #	PRICE
250 lb (113.4 kg)	21402	\$275.00
500 lb (226.8 kg)	21403	275.00
750 lb (340.2 kg)	21404	275.00
1000 lb (453.6 kg)	21405	275.00
1500 lb (680.4 kg)	21406	275.00
2000 lb (907.2 kg)	21407	275.00
2500 lb (1134.0 kg)	21408	275.00
3000 lb (1360.8 kg)	21409	315.00
5000 lb (2268.0 kg)	21410	440.00
10,000 lb (4535.9 kg)	21411	440.00
15,000 lb (6803.9 kg)	21412	555.00
20,000 lb (9071.9 kg)	21413	875.00
<b>Conduit Adapter Kit*(must be factory installed to maintain warranty)</b>		
3/8-24 Nipple	31533*	30.00
3/8-24 to 1/4-18 NPT	31534*	30.00

\*Parts #31533 and #31534 must be installed together to form the Conduit Adapter Kit

## Interchangeable Products

MANUFACTURER	MODEL
VPG Celtron	STC
VPG Sensortronics	60001

## Weigh Module Available

MANUFACTURER	MODEL
Rice Lake Weighing Systems	ITCM Isolated Tension Cell Mount

# RL20001 HE

S-Beam, Stainless Steel, NTEP 1:5000 Class III/1:10,000 Class IIIL Single Cell Welded-seal, IP68



Picture is a representation of actual product

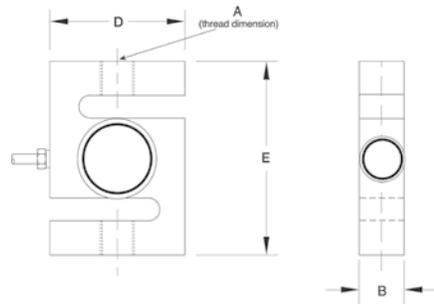

## Specifications

<p><b>Full Scale Output:</b> 2.0 mV/V</p> <p><b>Bridge Resistance:</b> 350 ohms, nominal</p> <p><b>Material/Finish:</b> Stainless steel</p> <p><b>Temperature:</b> Compensated range 14°F to 104°F/-10°C to 40°C</p>	<p><b>Safe Overload:</b> 150% Full scale</p> <p><b>Rated Excitation:</b> 10V DC (15V maximum)</p> <p><b>Nonlinearity:</b> 0.03% Full scale</p> <p><b>Hysteresis:</b> 0.02% Full scale</p>	<p><b>Insulation Resistance:</b> 5000 megohms</p> <p><b>Seal Type:</b> Welded-seal, IP68</p> <p><b>Cable Length:</b> 20 ft/6.1 m</p> <p><b>Cable Diameter:</b> .200 polyurethane jacket</p>	<p><b>Cable Color Code:</b> Red .....+ Excitation Black.....- Excitation Green .....+ Signal White .....- Signal</p> <p><b>Warranty:</b> Two-year limited warranty</p> <p><b>Approvals:</b></p>
--	---	---	---



## Dimensions

RATED CAPACITY	A	B	D	E
<b>lb/inches</b>				
500-3000	1/2-20 UNF	1.00	2.00	3.00
5000-10,000	3/4-16 UNF	1.00	3.50	4.75
<b>kg/mm</b>				
453.6-1360.8	1/2-20	25.4	50.8	76.2
2268.0-4535.9	3/4-16	25.4	88.9	120.7

## Order Information

LOAD RATING		PART #	PRICE
<b>RL20001 HE NTEP</b>			
500 lb	(226.8 kg)	46469	\$850.00
750 lb	(340.2 kg)	46470	850.00
1000 lb	(453.6 kg)	46471	850.00
1500 lb	(680.4 kg)	46472	850.00
2000 lb	(907.2 kg)	46473	850.00
2500 lb	(1134.0 kg)	46474	850.00
3000 lb	(1360.8 kg)	46475	850.00
5000 lb	(2268.0 kg)	46476	1,135.00
<b>RL20001 HE NON-NTEP</b>			
10,000 lb	(4535.9 kg)	36292	1,135.00

## Interchangeable Products

MANUFACTURER	MODEL
VPG Sensortronics	60063

## Weigh Module Available

MANUFACTURER	MODEL
Rice Lake Weighing Systems	ITCM Isolated Tension Cell Mount

# RLETS

S-Beam, Alloy Steel, Environmentally Sealed, OIML C3, IP67



Picture is a representation of actual product

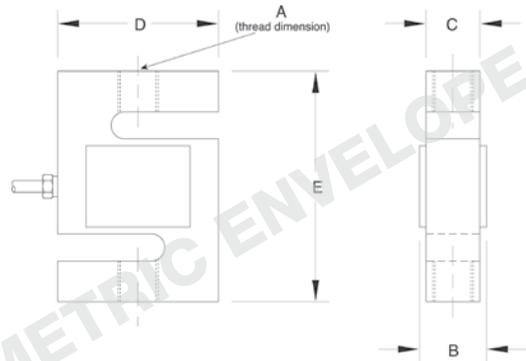

## Specifications

**Full Scale Output:**

3.0 mV/V  $\pm$ 0.25%

**Bridge Resistance:**

350 ohms, nominal

**Material/Finish:**

Alloy steel

**Temperature:**

Compensated range  
14°F to 104°F/-10°C to 40°C

**Seal Type:**

Environmentally sealed, IP67

**Safe Overload:**

150% Full scale

**Rated Excitation:**

10V AC/DC (15V maximum)

**Combined Error:**

0.02% Full scale

**Insulation Resistance:**

5000 megohms

**Cable Length:**

6m/19.7 ft

**Cable Diameter:**

.200 polyurethane jacket

**Cable Color Code:**

Red .....+ Excitation  
Black.....- Excitation  
Green .....+ Signal  
White .....- Signal

**Warranty:**

Two-year limited warranty

**Approvals:**

## Dimensions

RATED CAPACITY	A	B	C	D	E
<b>kg/mm</b>					
250-1000	M12 x 1.75-6H	25.4	19.1	50.8	76.0
2500	M20 x 1.5-6H	31.8	25.4	76.2	108.0
<b>lb/inches</b>					
551.2-2205.0	M12 x 1.75-6H	1.00	.75	2.00	3.00
5512.5	M20 x 1.5-6H	1.25	1.00	3.00	4.25

## Order Information

LOAD RATING		PART #	PRICE
250 kg	(551.2 lb)	31254	\$295.00
500 kg	(1102.3 lb)	31255	295.00
1000 kg	(2205.0 lb)	31256	295.00
2500 kg	(5512.5 lb)	31257	460.00



# RL30000

Single-Ended Beam, Alloy Steel, NTEP 1:5000 III L Class III Multiple Cell, IP67



Picture is a representation of actual product

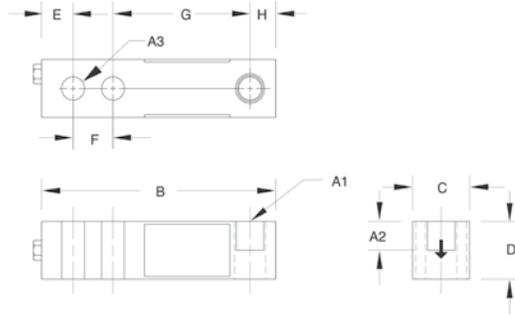

## Specifications

**Full Scale Output:**  
3.0mV/V

**Bridge Resistance:**  
350 ohms, nominal

**Material/Finish:**  
High-alloy steel, nickel plated

**Temperature:**  
Compensated range  
14°F to 104°F/-10°C to 40°C

**Seal Type:**  
Environmentally sealed, IP67

**Safe Overload:**  
150% Full scale

**Safe Sideload:**  
100% Full scale

**Rated Excitation:**  
10V DC (15V maximum)

**Nonlinearity:**  
0.03% Full scale

**Hysteresis:**  
0.02% Full scale

**Insulation Resistance:**  
5000 megohms

**Deflection at Capacity:**  
250-1000 lb = .013 in/.33 mm,  
2000-3000 lb = .015 in/.38 mm,  
4000-5000 lb = .025 in/.64 mm,  
10,000 lb = .032 in/.81 mm,  
15,000-20,000 lb = .038 in/.97 mm

**Cable Length:**  
20 ft/6.1 m

**Cable Diameter:**  
.200 polyurethane jacket

**Cable Color Code:**

Red .....+ Excitation  
Black.....- Excitation  
Green .....+ Signal  
White .....- Signal

**Warranty:**  
Two-year limited warranty

**Approvals:**



## Dimensions

RATED CAPACITY	A1*	A2†	A3*	B	C	D	E	F	G	H
<b>lb/inches</b>										
250-5000 SE	1/2-20 UNF-2B	.60	.53	5.12	1.25	1.25	.62	1.00	3.00	.50
5000 LE-10,000	3/4-16 UNF-2B	.75	.78	6.75	1.50	1.50	.75	1.50	3.75	.75
20,000	1-12 UNF-2B	1.00	1.03	8.75	2.00	2.00	1.00	2.00	4.75	1.00
<b>kg/mm</b>										
113.4-2268 SE	1/2-20 UNF-2B	15.2	13.5	130.1	31.8	31.8	15.8	25.4	76.2	12.7
2268.0 LE-4535.9	3/4-16 UNF-2B	19.1	19.8	171.5	38.1	38.1	19.1	38.1	95.3	19.1
9071.9	1-12 UNF-2B	25.4	26.2	222.3	50.8	50.8	25.4	50.8	120.7	25.4

\* Dimension A1 is identical to A3 on the RL30002 Thru-Hole Model. † Dimension

A2 applies to RL30000 Threaded-Hole Model ONLY

## Order Information

LOAD RATING	PART #	PRICE
<b>RL30000 NTEP, Threaded-Hole Design</b>		
1000 lb (453.6 kg)	21491	\$295.00
2000 lb (907.2 kg)	21493	295.00
2500 lb (1134.0 kg)	21495	295.00
3000 lb (1360.8 kg)	21497	295.00
4000 lb (1814.4 kg)	21498	295.00
5000 lb SE (2268.0 kg)	21500	295.00
5000 lb LE (2268.0 kg)	21501	375.00
10,000 lb (4535.9 kg)	21503	375.00
<b>RL30000 Non-NTEP, Threaded-Hole Design</b>		
250 lb (113.4 kg)	17341	295.00
500 lb (226.8 kg)	17342	295.00
20,000 lb (9071.9 kg)	17109	645.00
<b>Conduit Adapter Kit*(must be factory installed to maintain warranty)</b>		
3/8-24 Nipple	31533*	30.00
3/8-24 to 1/4-18 NPT	31534	30.00

\* Parts #31533 and #31534 must be installed together to form the Conduit Adapter Kit.

SE refers to small envelope.

LE refers to large envelope.

## Interchangeable Products

MANUFACTURER	MODEL
Threaded-Hole Design	—
VPG Revere Transducers	5123
VPG Tedeo-Huntleigh	3411
Artech®	30310

## Weigh Module Available

MANUFACTURER	MODEL
Rice Lake Weighing Systems	RL50210 TA
Rice Lake Weighing Systems	RL1800 Series

# RL30002 Thru Hole

Single-Ended Beam, Alloy Steel, NTEP 1:5000 IIIIL Class III Multiple Cell, IP67



Picture is a representation of actual product

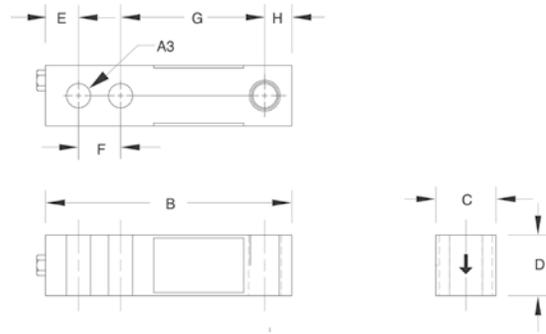

## Specifications

**Full Scale Output:**  
3.0mV/V

**Bridge Resistance:**  
350 ohms, nominal

**Material/Finish:**  
High-alloy steel, nickel plated

**Temperature:**  
Compensated range  
14°F to 104°F/-10°C to 40°C

**Seal Type:**  
Environmentally sealed, IP67

**Safe Overload:**  
150% Full scale

**Safe Sideload:**  
100% Full scale

**Rated Excitation:**  
10V DC (15V maximum)

**Nonlinearity:**  
0.03% Full scale

**Hysteresis:**  
0.02% Full scale

**Insulation Resistance:**  
5000 megohms

**Deflection at Capacity:**  
1000 lb = .013 in/.33 mm,  
2000-3000 lb = .015 in/.38 mm,  
4000-5000 lb = .025 in/.64 mm,

**Cable Length:**  
20 ft/6.1 m

**Cable Diameter:**  
200 polyurethane jacket

### Cable Color Code:

Red .....+ Excitation  
Black .....- Excitation  
Green .....+ Signal  
White .....- Signal

### Warranty:

Two-year limited warranty

### Approvals:



## Dimensions

RATED CAPACITY	A3*	B	C	D	E	F	G	H
<b>lb/inches</b>								
250-5000 SE	.53	5.12	1.25	1.25	.62	1.00	3.00	.50
<b>kg/mm</b>								
113.4-2268 SE	13.5	130.1	31.8	31.8	15.8	25.4	76.2	12.7

\* Dimension A1 is identical to A3 on the RL30002 Thru-Hole Model. † Dimension

## Order Information

LOAD RATING	PART #	PRICE
<b>RL30002 NTEP, Thru-Hole Design</b>		
1000 lb (453.6 kg)	21521	\$295.00
2000 lb (907.2 kg)	21522	295.00
2500 lb (1134.0 kg)	21523	295.00
4000 lb (1814.4 kg)	21524	295.00
5000 lb SE (2268.0 kg)	21525	295.00
<b>Conduit Adapter Kit* (must be factory installed to maintain warranty)</b>		
3/8-24 Nipple	31533*	30.00
3/8-24 to 1/4-18 NPT	31534*	30.00

## Interchangeable Products

MANUFACTURER	MODEL
Threaded-Hole Design	—
VPG Tedeo-Huntleigh	3410
Artech®	30210

# RLH35

Single-Ended Beam , Stainless Steel, NTEP 1:5000 Class IIIL Multiple Cell, Welded-seal, IP67



Picture is a representation of actual product

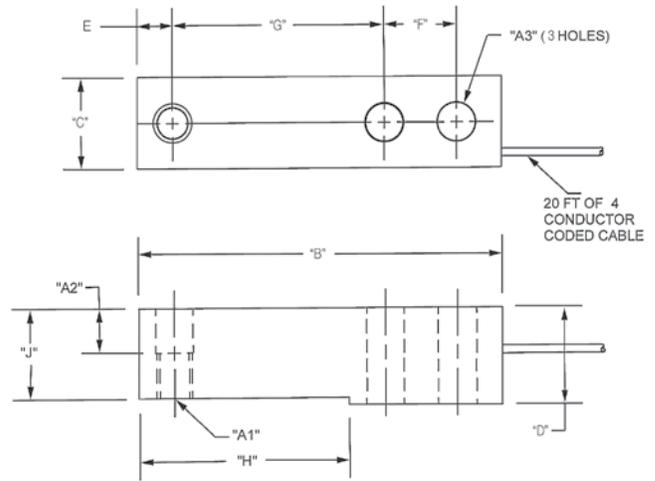

## Specifications

**Full Scale Output:**  
3.0mV/V

**Bridge Resistance:**  
350 ohms, nominal

**Material/Finish:**  
Stainless Steel

**Temperature:**  
Compensated range  
14°F to 104°F/-10°C to 40°C

**Safe Overload:**  
150% Full scale

**Rated Excitation:**  
10V DC (15V maximum)

**Nonlinearity:**  
0.17% Full scale

**Hysteresis:**  
0.17% Full scale

**Insulation Resistance:**  
5000 megohms

**Seal Type:**  
Welded-seal, IP67

**Cable Length:**  
20'/6.1 m

**Cable Diameter:**  
.190 polyurethane jacket

**Cable Color Code:**  
Green .....+ Excitation  
Black .....- Excitation  
White .....+ Signal  
Red .....- Signal  
Yellow .....Shield

**Warranty:**  
Two-year limited warranty

**Approvals:**



## Dimensions

RATED CAPACITY	A1	A2	A3	C	D	B	E	F	G	H
<b>lb/inches</b>										
500-5000	1/2-20 UNF-2B	.62	.53	1.21	1.19	5.12	.50	1.00	3.00	2.85
10,000	3/4-16 UNF-2B	.75	.78	1.44	1.44	6.75	.75	1.50	3.75	3.75
<b>kg/mm</b>										
453.6-2268	1/2-20 UNF-2B	15.8	13.5	30.7	30.2	130.05	12.7	25.4	76.2	72.4
4539.9	3/4 16 UNF02B	19.1	19.8	36.6	36.6	171.5	19.1	38.1	95.3	95.3

## Order Information

LOAD RATING	PART #	PRICE
500 lb (226.8 kg)	106038	\$385.00
1,000 lb (453.6 kg)	106039	385.00
2,500 lb (1134.0 kg)	106040	385.00
4,000 lb (1814.4 kg)	106041	385.00
5,000 lb (2268.0 kg)	106042	385.00

## Interchangeable products

MANUFACTURER	PART #
<b>Mettler Toledo®</b>	
500 lb-8 ft cable	TB601019-008
1,000 lb-20 ft cable	TB601016-020
2,500 lb-8 ft cable	TB601016-008
4,000 lb-20 ft cable	TB601017-020
5,000 lb-8 ft cable	TB601018-008
<b>HBM</b>	
H35	-

# RL39123

Single-Ended Beam, Stainless Steel



Picture is a representation of actual product

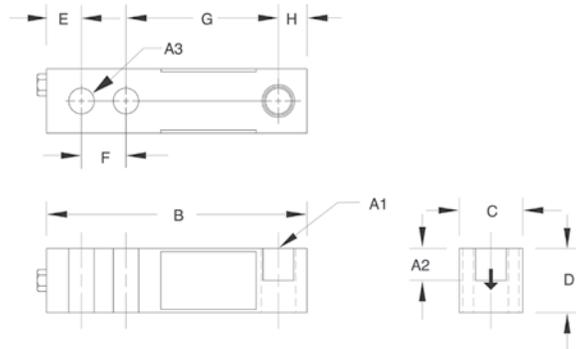

## Specifications

### Full Scale Output:

3.0 mV/V

### Output Resistance:

349-355 ohms

### Input Resistance:

343-357 ohms

### Material/Finish:

Stainless steel

### Temperature:

Compensated range  
0°F to 150°F/-18°C to 65°C

### Seal Type:

Environmentally sealed

### Safe Overload:

150% Full scale

### Safe Sideload:

100% Full scale

### Rated Excitation:

10V DC (15V maximum)

### Nonlinearity:

0.03% Full scale

### Hysteresis:

0.02% Full scale

### Insulation Resistance:

5000 megohms

### Deflection at Capacity:

250-1000 lb=.013 in/.33 mm,  
2000-3000 lb=.015 in/.38 mm,  
4000-5000 lb=.025 in/.64 mm,  
10,000 lb=.32 in/.81 mm,  
15,000-20,000 lb=.038 in/.97 mm

### Cable Length:

20 ft/6.1 m

### Cable Diameter:

.200 polyurethane jacket

### Cable Color Code:

Red ..... + Excitation  
Black ..... - Excitation  
Green ..... + Signal  
White ..... - Signal

### Warranty:

Two-year limited warranty

### Approvals:



## Dimensions

RATED CAPACITY	A1	A2	A3	B	C	D	E	F	G	H
<b>lb/inches</b>										
250-4000	1/2-20 UNF-2B	.60	.53	5.12	1.25	1.25	.62	1.00	3.00	.50
5000-10,000	3/4-16 UNF-2B	.75	.78	6.75	1.50	1.50	.75	1.50	3.75	.75
<b>kg/mm</b>										
113.4-1814.4	1/2-20 UNF-2B	15.2	13.5	130.1	31.8	31.8	15.8	25.4	76.2	12.7
2268.0-4535.9	3/4-16 UNF-2B	19.1	19.8	171.5	38.1	38.1	19.1	38.1	95.3	19.1
6803.9	1-12 UNF-2B	25.4	26.2	222.3	50.8	50.8	25.4	50.8	120.7	25.4

## Order Information

LOAD RATING	PART #	PRICE
250 lb (113.4 kg)	17386	\$350.00
500 lb (226.8 kg)	17387	350.00
1,000 lb (453.6 kg)	17189	350.00
2,500 lb (1134.0 kg)	17191	350.00
4,000 lb (1814.4 kg)	17193	350.00
5,000 lb (2268.0 kg)	17194	420.00
10,000 lb (4535.9 kg)	17195	420.00
<b>Conduit Adapter Kit*(must be factory installed to maintain warranty)</b>		
3/8-24 Nipple	31533*	30.00
3/8-24 to 1/4-18NPT	31534*	30.00

\* Parts # 31533 and # 31534 must be installed together to form the Conduit Adapter Kit

## Interchangeable Products

MANUFACTURER	MODEL
VPG Revere Transducers	9123
Artech®	SS30310
HBM®	B35

## Weigh Module Available

MANUFACTURER	MODEL
Rice Lake Weighing Systems	RL50210 TA
Rice Lake Weighing Systems	RL1800 Series

# RL30745

Single-Ended Beam, Stainless Steel, Welded-seal, IP67, NTEP 1:5000 Class III Multiple



500 lb model

Picture is a representation of actual product

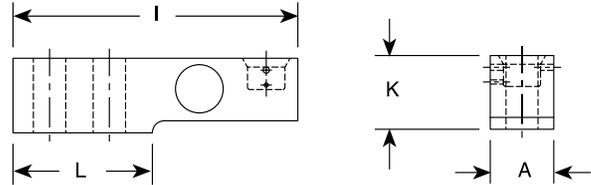
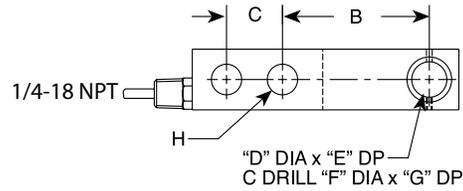

## Specifications

**Full Scale Output:**  
2.0 mV/V

**Bridge Resistance:**  
350 ohms, nominal

**Material/Finish:**  
Stainless steel

**Temperature:**  
Compensated range  
14°F to 104°F / -10°C to 40°C

**Safe Overload:**  
150% Full scale

**Safe Sideload:**  
100% Full scale

**Rated Excitation:**  
10V DC (15V maximum)

**Combined Error:**  
0.03%

**Non-repeatability:**  
0.01% Full scale

**Insulation Resistance:**  
5000 megohms

**Seal Type:**  
Welded-seal, IP67

**Cable Length:**  
30 ft/9.1 m/15 ft

**Cable Diameter:**  
.190 polyurethane jacket

**Deflection:**  
500-2.5 k .010 in  
5 k + 10 k .012 in

### Cable Color Code:

Green .....+ Excitation  
Black .....- Excitation  
White .....+ Signal  
Red .....- Signal  
Yellow .....Shield

**Warranty:**  
Two-year limited warranty

### Approvals:



## Dimensions

RATED CAPACITY	A	B	C	D	E	F	G	H	I	K	L
<b>lb/inches</b>											
500-4,000	1.20	3.00	1.00	.63	.68	.507	.189	.500	5.25	1.22	2.27
5,000	1.46	3.00	1.00	.63	.92	.539	.38	.500	5.38	1.40	2.28
10,000	1.68	3.75	1.50	.88	1.06	.533	.44	.750	6.87	1.68	3.03
<b>kg/mm</b>											
226.8-1814.2	30.5	76.2	25.4	16.0	17.5	22.4	4.8	12.7	133.3	30.9	57.6
2268	37.1	76.2	25.4	16.0	23.4	22.4	9.7	12.7	136.7	35.5	57.9
4536	42.7	95.3	38.1	22.4	26.9	35.1	11.8	19.1	174.5	42.6	76.9

## Order Information

LOAD RATING	PART #	PRICE
<b>30' cables</b>		
500 lb (226.8 kg)	76213	\$450.00
1,250 lb (567.0 kg)	47946	450.00
2,500 lb (1,134 kg)	45463	450.00
5,000 lb (2,268 kg)	45465	575.00
10,000 lb (4,536 kg)	45466	695.00
<b>15' cables</b>		
500 lb (226.8 kg)	101091	410.00
1,250 lb (567.0 kg)	101092	410.00
2,500 lb (1,134 kg)	101093	410.00
5,000 lb (2,268 kg)	101094	535.00
10,000 lb (4,536 kg)	101095	660.00
Rocker Pin 500-4 K	108612	62.00
Rocker Pin 5 K	130408	64.00
Rocker Pin 10 K	131376	94.00
O-ring*	108202	1.00

\*Two per pin

## Interchangeable Products

MANUFACTURER	MODEL
Mettler-Toledo®	TB600529-500 lb
Mettler-Toledo	TB600363-1250 lb
Mettler-Toledo	TB600342-2500 lb
Mettler-Toledo	TB600343-5000 lb
Mettler-Toledo	TB600364-10000 lb
HBM®	THC

# RLBLC

Single-Ended Beam, Stainless Steel with Counter Bore

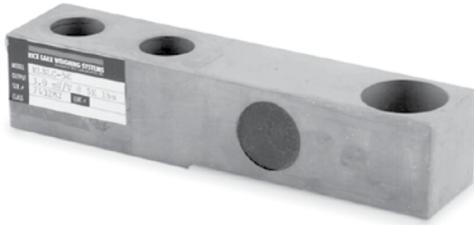

Picture is a representation of actual product

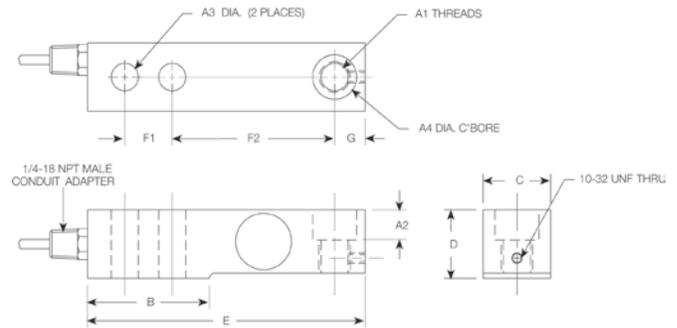

## Specifications

### Full Scale Output:

3.0 mV/V nominal

### Bridge Resistance:

1000 ohms, nominal

### Material/Finish:

Stainless steel

### Temperature:

Compensated range  
15°F to 115°F/-9°C to 46°C

### Seal Type:

Environmentally sealed

### Safe Overload:

150% Full scale

### Safe Sideload:

100% Full scale

### Rated Excitation:

10V DC (15V maximum)

### Nonlinearity:

0.03% Full scale

### Hysteresis:

0.05% Full scale

### Insulation Resistance:

5000 megohms

### Deflection at Capacity:

1000-4000 lb=.010 in/.25 mm,  
5000-10,000 lb=.012 in/.30 mm

### Cable Length:

1000-4000 lb=10 ft/3.1 m  
5000-10,000 lb=20 ft/6.1 m

### Cable Diameter:

.190 polyurethane jacket

### Cable Color Code:

Green .....+ Excitation  
Black .....- Excitation  
White .....+ Signal  
Red .....- Signal

### Warranty:

Two-year limited warranty

## Dimensions

RATED CAPACITY	A1	A2	A3	A4	B	C	D	E	F1	F2	G
<b>lb/inches</b>											
1000-4000	1/2-20 UNF-2B	.56	.53	.81	2.25	1.21	1.19	5.25	1.00	3.00	.60
5000	3/4-16 UNF-2B	.79	.78	1.19	3.00	1.45	1.44	6.75	1.50	3.75	.75
10,000	3/4-16 UNF-2B	.79	.78	1.19	3.00	1.69	1.69	6.75	1.50	3.75	.75
<b>kg/mm</b>											
453.6-1814.4	1/2-20 UNF-2B	14.2	13.5	20.6	57.2	30.2	30.2	130.1	25.4	76.2	12.7
2268.0	3/4-16 UNF-2B	20.1	19.8	30.2	76.2	36.6	36.6	171.5	38.1	95.3	19.1
4535.9	3/4-16 UNF-2B	20.1	19.8	30.2	76.2	36.6	49.3	171.5	38.1	95.3	19.1

## Order Information

LOAD RATING	PART #	PRICE
1,000 lb (453.6 kg)	17091	\$395.00
2,500 lb (1134.0 kg)	17096	395.00
4,000 lb (1814.4 kg)	17101	395.00
5,000 lb (2268.0 kg)	17104	495.00
10,000 lb (4535.9 kg)	17108	495.00
<b>Bushing (for conversion to non-counter bore)</b>		
1,000 lb-4,000 lb, SST	17691	8.00

## Interchangeable Products

MANUFACTURER	MODEL
HBM®	BLC

# RL35023

Single-Ended Beam, Alloy Steel, NTEP 1:5000 Class III Multiple Cell, IP67



Picture is a representation of actual product

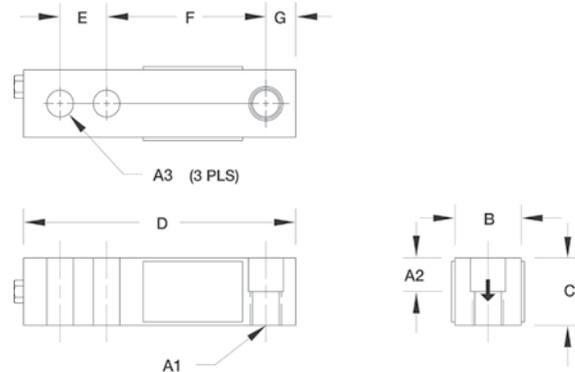

## Specifications

<b>Full Scale Output:</b> 3.0 mV/V	<b>Safe Overload:</b> 150% Full scale	<b>Insulation Resistance:</b> 5000 megohms	<b>Cable Diameter:</b> .200 polyurethane jacket
<b>Output Resistance:</b> 349-355 ohms	<b>Safe Sideload:</b> 100% Full scale	<b>Deflection at Capacity:</b> 500-1000 lb=.013 in/.3 mm, 2000-3000 lb=.015 in/.4 mm, 4000-5000 lb=.025 in/.6 mm, 10,000 lb=.035 in/.9 mm	<b>Cable Color Code:</b> Red .....+ Excitation Black.....- Excitation Green.....+ Signal White.....- Signal
<b>Input Resistance:</b> 343-357 ohms	<b>Rated Excitation:</b> 10V DC (15V maximum)	<b>Seal Type:</b> Environmentally sealed, IP67	<b>Warranty:</b> Two-year limited warranty
<b>Material/Finish:</b> High-alloy steel, nickel plated	<b>Nonlinearity:</b> 0.03% Full scale	<b>Cable Length:</b> 20 ft/6.1 m	<b>Approvals:</b>   
<b>Temperature:</b> Compensated range 14°F to 104°F/-10°C to 40°C	<b>Hysteresis:</b> 0.02% Full scale		

## Dimensions

RATED CAPACITY	A1	A2	A3	B	C	D	E	F	G
<b>lb/inches</b>									
500	1/2-20 UNF-2B	.50	.53	1.25	1.00	5.12	1.00	3.00	.50
1000-5000 SE	1/2-20 UNF-2B	.62	.53	1.25	1.25	5.12	1.00	3.00	.50
5000 LE-10,000	3/4-16 UNF-2B	.75	.78	1.50	1.50	6.75	1.50	3.75	.75
15,000-20,000	1-14 UNS-2B	1.00	1.03	2.00	2.00	8.88	2.00	4.88	1.03
<b>kg/mm</b>									
226.8	1/2-20 UNF-2B	12.7	13.5	31.8	25.4	130.1	25.4	76.2	12.7
453.6-2268.0 SE	1/2-20 UNF-2B	15.8	13.5	31.8	31.8	130.1	25.4	76.2	12.7
2268.0 LE-4535.9	3/4-16 UNF-2B	19.1	19.8	38.1	38.1	171.5	38.1	95.3	19.8
6803.9-9071.9	1-14 UNS-2B	25.4	26.2	50.8	50.8	225.6	50.8	124.0	25.0

## Order Information

LOAD RATING	PART #	PRICE
1,000 lb (453.6 kg)	21528	\$295.00
2,000 lb (907.2 kg)	21529	295.00
2,500 lb (1134.0 kg)	21530	295.00
3,000 lb (1360.8 kg)	21531	295.00
4,000 lb (1814.4 kg)	21532	295.00
5,000 lb SE (2268.0 kg)	21535	295.00
5,000 lb LE (2268.0 kg)	21533	375.00
10,000 lb (4535.9 kg)	21534	375.00
<b>Non-NTEP</b>		
500 lb (226.8 kg)	17181	295.00
15,000 lb (6803.9 kg)	17186	645.00
20,000 lb (9071.9 kg)	17187	645.00
<b>Conduit Adapter Kit* (must be factory installed to maintain warranty)</b>		
3/8-24 Nipple	31533*	30.00
3/8-24 to 1/4-18 NPT	31534*	30.00

## Interchangeable Products

MANUFACTURER	MODEL
VPG Celtron	SQB
VPG Sensortronics	65023

## Weigh Module Available

MANUFACTURER	MODEL
Rice Lake Weighing Systems	RL50210TA
Rice Lake Weighing Systems	RL1800 Series

SE refers to small envelope

LE refers to large envelope

\*Parts #31533 and #31534 must be installed together to form the Conduit Adapter Kit

# RL35023S

Single-Ended Beam, Stainless Steel, NTEP 1:5000 Class III Multiple Cell, IP67



Picture is a representation of actual product

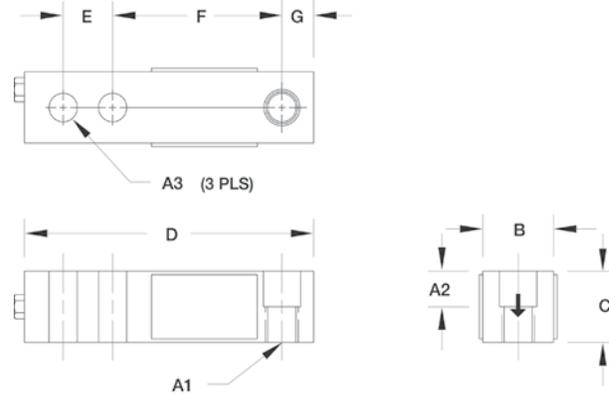

## Specifications

**Full Scale Output:**  
3.0 mV/V

**Output Resistance:**  
349-355 ohms

**Input Resistance:**  
343-357 ohms

**Material/Finish:**  
Stainless steel

**Temperature:**  
Compensated range  
14°F to 104°F/-10°C to 40°C

**Safe Overload:**  
150% Full scale

**Safe Sideload:**  
100% Full scale

**Rated Excitation:**  
10V DC (15V maximum)

**Nonlinearity:**  
0.03% Full scale

**Deflection at Capacity:**  
500-1500 lb=0.013 in/0.33 mm,  
1000-5000 lb=0.017-0.025 in,  
5000-10,000 lb=0.025-0.035 in,  
15,000-20,000 lb=0.048-0.013 in

**Seal Type:**  
Environmentally sealed, IP67

**Cable Length:**  
20 ft/6.1 m

**Cable Diameter:**  
.200 polyurethane jacket

**Cable Coloring:**  
Red .....+ Excitation  
Black.....- Excitation  
Green.....+ Signal  
White .....- Signal

**Hysteresis:**  
0.02% Full scale

**Insulation Resistance:**  
5000 megohms

**Warranty:**  
Two-year limited warranty

**Approvals:**



## Dimensions

RATED CAPACITY	A1	A2	A3	A4	B	C	D	E	F	G
<b>lb/inches</b>										
1000-4000	1/2-20 UNF-2B	.62	.53	.53 DIA.	1.25	1.25	5.12	1.00	3.00	.50
5000-10,000	3/4-16 UNF-2B	.75	.78	.78 DIA.	1.50	1.50	6.75	1.50	3.75	.75
<b>kg/mm</b>										
453.6-1814.4	1/2-20 UNF-2B	15.8	13.5	13.5 DIA.	31.8	31.8	130.1	25.4	76.2	12.7
2268.0-4535.9	3/4-16 UNF-2B	19.1	19.8	19.8 DIA.	38.1	38.1	171.5	38.1	95.3	19.1

## Order Information

LOAD RATING	PART #	PRICE
1000 lb (453.6 kg)	30649	\$365.00
2000 lb (907.2 kg)	30650	365.00
2500 lb (1134.0 kg)	30651	365.00
4000 lb (1814.4 kg)	30652	365.00
5000 lb (2268.0 kg)	30653	430.00
10,000 lb (4535.9 kg)	30654	430.00
<b>Conduit Adapter Kit* (must be factory installed to maintain warranty)</b>		
3/8-24 Nipple	31533*	30.00
3/8-24 to 1/4-18 NPT	31534*	30.00

\*Parts #31533 and #31534 must be installed together to form the Conduit Adapter Kit

## Interchangeable Products

MANUFACTURER	MODEL
VPG Sensortronics	65023 S
VPG Sensortronics	65023 SS
SQB HSS	

## Weigh Module Available

MANUFACTURER	MODEL
Rice Lake Weighing Systems	RL50210
Rice Lake Weighing Systems	RL1800 Series



# RL35083

Single-Ended Beam , Stainless Steel, Welded-seal, IP67



Picture is a representation of actual product

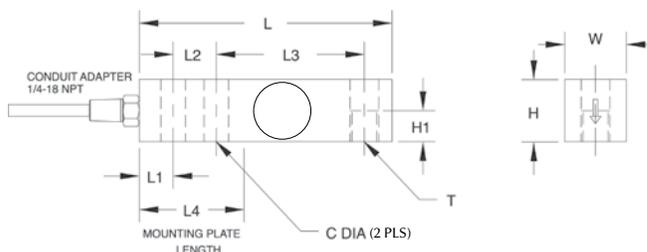

## Specifications

**Full Scale Output:**  
3.0mV/V

**Output Resistance:**  
349-355 ohms

**Input Resistance:**  
343-357 ohms

**Material/Finish:**  
Stainless steel

**Temperature:**  
Compensated range  
0°F to 150°F/-18°C to 65°C

**Safe Overload:**  
150% Full scale

**Safe Sideload:**  
100% Full scale

**Rated Excitation:**  
10V DC (15V maximum)

**Combined Error:**  
0.03% Full scale

**Non-Repeatability:**  
0.01% Full scale

**Insulation Resistance:**  
5000 megohms

**Deflection at Capacity:**

1000-4000 lb=.0008-0.026"/.33 mm,  
5000-10,000 lb=.030-0.055"/.81 mm

**Seal Type:**

Welded-seal strain gauge\*, IP67

**Cable Length:**

20 ft/6.1 m

**Cable Diameter:**

.220 PTFE coated cable

**Conduit Adapter Size:**

1/4-18 NPT

**Cable Color Code:**

Red .....+ Excitation  
Black.....- Excitation  
Green .....+ Signal  
White .....- Signal

**Warranty:**

Two-year limited warranty

**Approvals:**



## Dimensions

RATED CAPACITY	C	H	H1	L	L1	L2	L3	L4	T	W
<b>lb/inches</b>										
1000-4000	.53	1.22	.61	5.12	.62	1.00	3.00	2.25	1/2-20 UNF-2B	1.22
5000-10,000	.78	1.50	.75	6.75	.75	1.50	3.75	3.00	3/4-16 UNF-2B	1.50
<b>kg/mm</b>										
453.6-1814.4	13.5	31.0	15.5	130.0	15.7	25.4	76.2	57.2	1/2-20 UNF-2B	31.0
2268.0-4535.9	19.8	38.1	19.1	171.5	19.1	38.1	95.3	76.2	3/4-16 UNF-2B	38.1

## Order Information

LOAD RATING	PART #	PRICE
1000 lb (453.6 kg)	17252	\$405.00
2500 lb (1134.0 kg)	17253	405.00
4000 lb (1814.4 kg)	17254	405.00
5000 lb (2268.0 kg)	17255	455.00
10,000 lb (4535.9 kg)	17256	455.00

\*Conduit is recommended for maximum protection against the ingress of water and moisture through the cable entry

## Interchangeable Products

MANUFACTURER	MODEL
VPG Sensortronics	65083
VPG Celtron	SQB-HSS

## Weigh Module Available

MANUFACTURER	MODEL
Rice Lake Weighing Systems	RL50210
Rice Lake Weighing Systems	RL1800 Series

# RL35082

Single-Ended Beam, Stainless Steel, NTEP 1:5000 Class III Multiple Cell, Welded-Seal, IP67, 66/68\*\*



Picture is a representation of actual product

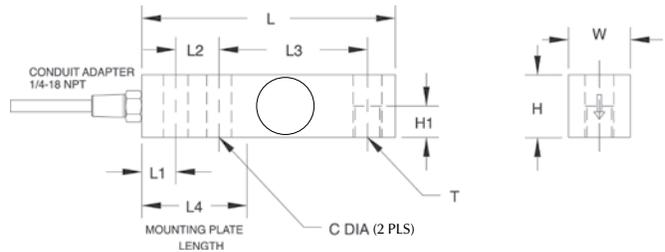

## Specifications

**Full Scale Output:**  
2.0 mV/V**Output Resistance:**  
349-355 ohms**Input Resistance:**  
343-357 ohms**Material/Finish:**  
Stainless steel**Temperature:**  
Compensated range  
14°F to 104°F/-10°C to 40°C**Safe Overload:**  
150% Full scale**Safe Sideload:**  
100% Full scale**Rated Excitation:**  
10V DC (15V maximum)**Combined Error:**  
0.02% Full scale**Non-Repeatability:**  
0.01% Full scale**Insulation Resistance:**  
5000 megohms**Deflection at Capacity:**  
1000-4000 lb=.012"/.33 mm,  
5000-10,000 lb=.030"/.81 mm**Seal Type:**  
Welded-seal strain gauge\*, IP67**Cable Length:**  
20 ft/6.1 m**Cable Diameter:**  
.220 PTFE coated cable**Conduit Adapter Size:**  
1/4-18 NPT\*\***Cable Color Code:**  
Red .....+ Excitation  
Black.....- Excitation  
Green .....+ Signal  
White .....- Signal**Warranty:**  
Two-year limited warranty**Approvals:**

## Dimensions

RATED CAPACITY	C	H	H1	L	L1	L2	L3	L4	T	W
<b>lb/inches</b>										
1000-4000	.53	1.22	.61	5.12	.62	1.00	3.00	2.25	1/2-20 UNF-2B	1.22
5000-10,000	.78	1.50	.75	6.75	.75	1.50	3.75	3.00	3/4-16 UNF-2B	1.50
<b>kg/mm</b>										
453.6-1814.4	13.5	31.0	15.5	130.0	15.7	25.4	76.2	57.2	1/2-20 UNF-2B	31.0
2268.0-4535.9	19.8	38.1	19.1	171.5	19.1	38.1	95.3	76.2	3/4-16 UNF-2B	38.1

## Order Information

LOAD RATING	PART #	PRICE
<b>IP67 RL35082 N5 Model</b>		
1000 lb (453.6 kg)	31283	\$425.00
2500 lb (1134.0 kg)	31282	425.00
4000 lb (1814.4 kg)	31281	425.00
5000 lb (2268.0 kg)	31280	475.00
10,000 lb (4535.9 kg)	31279	475.00
<b>IP66/68** RL35082 HE Model</b>		
1000 lb (453.6 kg)	34702	505.00
2500 lb (1134.0 kg)	34703	505.00
4000 lb (1814.4 kg)	34704	505.00
5000 lb (2268.0 kg)	34705	555.00
10,000 lb (4535.9 kg)	34706	555.00

\*Conduit is recommended for maximum protection against the ingress of water and moisture through the cable entry

\*\*IP66/68 Hermetically sealed versions have 1/2-14 NPT conduit adapter

## Interchangeable Products

MANUFACTURER	MODEL
VPG Sensortronics	65083 S

## Weigh Module Available

MANUFACTURER	MODEL
Rice Lake Weighing Systems	RL50210
Rice Lake Weighing Systems	RL1800 Series

# RLETB

Single-Ended Beam , Alloy Steel, OIML C3, IP67



Picture is a representation of actual product

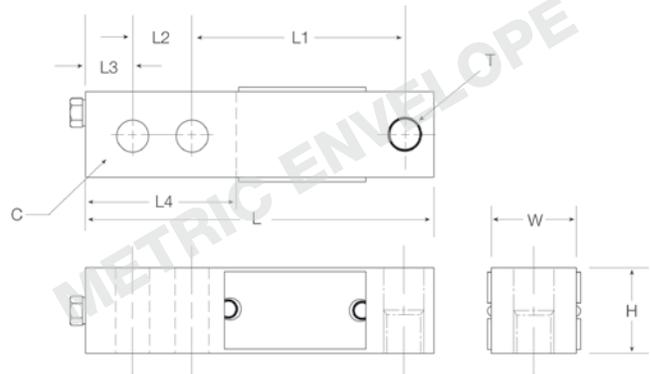

## Specifications

**Full Scale Output:**  
3.0mV/V

**Output Resistance:**  
349-355 ohms

**Input Resistance:**  
343-357 ohms

**Material/Finish:**  
Alloy steel

**Temperature:**  
Compensated range  
14°F to 104°F/-10°C to 40°C

**Safe Overload:**  
150% Full scale

**Safe Sideload:**  
100% Full scale

**Rated Excitation:**  
10V DC (15V maximum)

**Combined Error:**  
0.03% Full scale

**Insulation Resistance:**  
5000 megohms

**Seal Type:**  
Environmentally sealed, IP67

**Cable Length:**  
6 m/19.7 ft

**Cable Diameter:**  
.200 polyurethane jacket

**Cable Color Code:**  
Red .....+ Excitation  
Black.....- Excitation  
Green .....+ Signal  
White .....- Signal

**Warranty:**  
Two-year limited warranty

**Approvals:**



## Dimensions

RATED CAPACITY C	H	L	L1	L2	L3	L4	W	T
<b>kg/mm</b>								
500-2000	57.0	32.0	130.0	76.0	25.0	16.0	13.0	M12 x 1.75-6H
5000	76.0	38.0	171.0	95.0	38.0	19.0	20.7	M20 x 1.5-6H
<b>lb/inches</b>								
1102.3-4409.2	2.25	1.25	5.12	3.00	.98	.63	.51	M12 x 1.75-6H
11,023.1	3.00	1.50	6.73	3.74	1.50	.75	.81	M20 x 1.5-6H

## Order Information

LOAD RATING	PART #	PRICE
500 kg (1102.5 lb)	31249	\$325.00
1000 kg (2205.0 lb)	31248	325.00
2000 kg (4410.0 lb)	31247	325.00
5000 kg (11,025.0 lb)	31246	405.00

# RLHTO

Single-Ended Beam, Stainless Steel, Hermetically Sealed, IP66/68, OIML C3



Picture is a representation of actual product

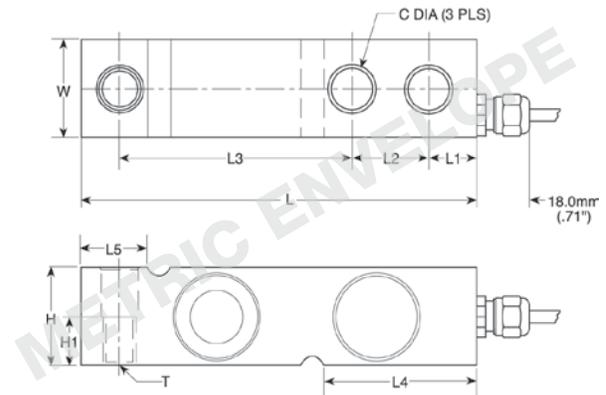

## Specifications

**Full Scale Output:**  
2.0 m-V/V

**Output Resistance:**  
350 ohms, +/- 3

**Input Resistance:**  
380 ohms, +/- 10

**Material/Finish:**  
Stainless steel

**Temperature:**  
Compensated range  
14°F to 104°F/-10°C to 40°C

**Safe Overload:**  
150% Full scale

**Safe Sideload:**  
100% Full

**Rated Excitation:**  
10V DC (15V maximum)

**Total Error:**  
0.02% Applied Load

**Insulation Resistance:**  
2000 megohms

**Deflection at Capacity:**  
500-5000 kg=.4 mm/.015 in

**Seal Type:**  
Hermetically sealed, IP66/68

**Cable Length:**  
5 m/16.4 ft

**Cable Diameter:**  
.220 polyurethane jacket

### Cable Color Code:

Blue .....+ Excitation  
Black.....- Excitation  
Green .....+ Sense  
Grey .....- Sense  
White .....+ Signal  
Red .....- Signal

**Warranty:**  
Two-year limited warranty

### Approvals:



## Dimensions

RATED CAPACITY	C	H	H1	L	L1	L2	L3	L4	L5	T	W
<b>lb/inches</b>											
1102.3-4409.2	.53	1.26	.63	5.12	.62	1.00	3.00	1.99	.93	M12 X 1.75.	1.26
11,023.1	.80	1.89	—	6.75	.75	1.50	3.75	2.76	1.46	—	1.44
<b>kg/mm</b>											
500-2000	13.5	32.0	16.0	130.0	15.8	25.4	76.2	50.5	23.5	M12 x 1.75.	32.0
5000	20.5	48.0	—	171.5	19.0	38.1	95.3	70.0	37.0	—	36.5

## Interchangeable Products

LOAD RATING		PART #	PRICE
C3 500 kg	(1102.5 lb)	31253	\$485.00
C3 1000 kg	(2205.0 lb)	31250	485.00
C3 2000 kg	(4410.0 lb)	31251	485.00
C3 5000 kg	(11,025.0 lb)	31252	555.00

## Interchangeable Products

MANUFACTURER	MODEL
VPG Tedeo-Huntleigh	3510 kg

## Weigh Module Available

MANUFACTURER	MODEL
Rice Lake Weighing Systems	1700HE

# RLSSB

Single-Ended Beam, Stainless Steel, Welded-Seal, NTEP 1:5000 Class III Multiple Cell, IP67



Picture is a representation of actual product

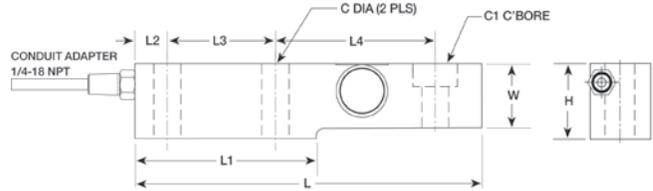

## Specifications

**Full Scale Output:**  
2.0mV/V

**Bridge Resistance:**  
350 ohms, nominal

**Material/Finish:**  
Stainless steel

**Temperature:**  
Compensated range  
14°F to 104°F/-10°C to 40°C

**Safe Overload:**  
150% Full scale

**Safe Sideload:**  
100% Full scale

**Rated Excitation:**  
10V DC (15V maximum)

**Combined Error:**  
0.02%

**Non-repeatability:**  
0.01% Full scale

**Insulation Resistance:**  
5000 megohms

**Seal Type:**  
Welded-seal, IP67

**Cable Length:**  
15 ft/4.5 m

**Cable Diameter:**  
.200 polyurethane jacket

**Cable Color Code:**

- Green .....+ Excitation
- Black.....- Excitation
- White .....+ Signal
- Red .....- Signal

**Warranty:**  
Two-year limited warranty

**Approvals:**



## Dimensions

RATED CAPACITY	C	C1	H	L	L1	L2	L3	L4	W
<b>lb/inches</b>									
1000-5000	.53	.68 THRU C'BORE 1.19 x .47 DP	1.88	8.00	4.00	.75	2.50	3.88	1.44
10,000	.88	1.00 THRU C'BORE 1.63 x .62 DP	2.75	9.25	4.62	.81	2.63	4.88	1.88
<b>kg/mm</b>									
453.6-2268.0	13.5	.68 THRU C'BORE 1.19 x .47 DP	47.8	203.2	101.6	19.1	63.5	98.6	36.6
4535.9	22.4	1.00 THRU C'BORE 1.63 x .62 DP	69.9	235.0	117.3	20.6	66.8	124.0	47.8

## Order Information

LOAD RATING		PART #	PRICE
1000 lb	(453.6 kg)	34310	\$600.00
2000 lb	(907.2 kg)	34311	600.00
5000 lb	(2268.0 kg)	34312	600.00
10,000 lb	(4535.9 kg)	34313	715.00
1-5 k, Stainless Steel			
Load cell button	—	26112	30.00

## Interchangeable Products

MANUFACTURER	MODEL
HBM®	SB3
VPG Revere Transducers	SSB
Artech®	SS30610

## Weigh Module Available

MANUFACTURER	MODEL
Rice Lake Weighing Systems	Mount Kit RL1900

# RLSB250/RLSB250T

Single-Ended Beam, Stainless Steel, Welded-Seal, NTEP 1:5000 Class III Multiple Cell, IP67



Threaded Versions  
Now Available

Picture is a representation of actual product

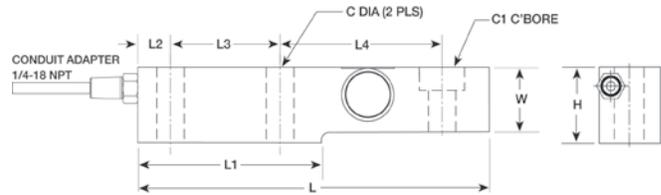

## Specifications

### Full Scale Output:

2.0mV/V

### Bridge Resistance:

350 ohms, nominal

### Material/Finish:

Stainless steel

### Temperature:

Compensated range  
14°F to 104°F/-10°C to 40°C

### Safe Overload:

150% Full scale

### Safe Sideload:

100% Full scale

### Rated Excitation:

10V DC (15V maximum)

### Combined Error:

0.02%

### Non-repeatability:

0.01% Full scale

### Insulation Resistance:

5000 megohms

### Seal Type:

Welded-seal, IP67

### Cable Length:

20 ft/6.2 m

### Cable Diameter:

.200 polyurethane jacket

### Cable Color Code:

Green .....+ Excitation  
Black.....- Excitation  
White .....+ Signal  
Red .....- Signal

### Warranty:

Two-year limited warranty

### Approvals:



## Dimensions

RATED CAPACITY C	C1	H	L	L1	L2	L3	L4	T*	W
<b>lb/inches</b>									
2500-5000	.53	.68 THRU C'BORE 1.19 x .47 DP	1.88	8.00	4.00	.75	2.50	3/4-16 UNF	1.44
10,000 lb	—	1.00 thru 1.63 x .62 DP	2.46	9.00	4.00	.75	2.00	—	1.62
<b>kg/mm</b>									
1134.0	13.5	.68 THRU C'BORE 1.19 x .47 DP	47.8	203.2	101.6	19.1	63.5	—	36.6

## Order Information

LOAD RATING		PART #	PRICE
*2500 lb	(1134.0 kg)	34482	\$600.00
2500 lb	(1134.0 kg)	116053	600.00
5000 lb	(2268.0 kg)	116054	700.00
*10,000 lb	(4536.0 kg)	116055	700.00
Insert	—	116084	9.00

\*No threads in load hole

## Interchangeable Products

MANUFACTURER	MODEL
Cardinal®	SB2500*

# RLSB2L

Single-Ended Beam , Hermetically Sealed, IP67



Picture is a representation of actual product

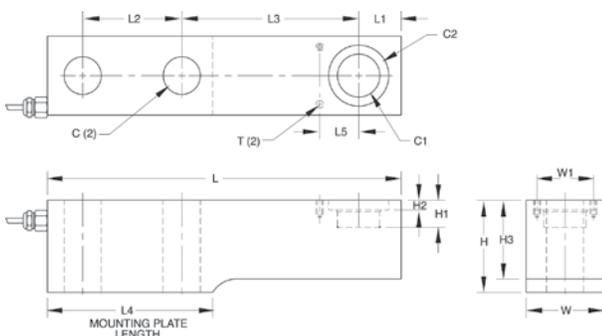

RLSB2L - 35,000-45,000 lb/15,876-20,411.7 kg

## Specifications

**Full Scale Output:**  
2.0 mV/V ± .07% (matched)

**Bridge Resistance:**  
350 ohms, nominal

**Material/Finish:**  
35,000-45,000 lb-High-alloy steel,  
epoxy coated

**Temperature:**  
Compensated range  
15°F to 115°F/-9°C to 46°C

**Safe Overload:**  
150% Full scale

**Safe Sideload:**  
100% Full scale

**Rated Excitation:**  
10V DC (15V maximum)

**Nonlinearity:**  
0.03% Full scale

**Hysteresis:**  
0.03% Full scale

**Insulation Resistance:**  
10,000 megohms

**Seal Type:**  
35,000 and 45,000 lb/15,875.7 and  
20,411.7 kg, Hermetically sealed, IP67

**Cable Length:**  
35,000-45,000 lb=30 ft/9.2 m

**Cable Diameter:**  
.299 polyurethane jacket

**Cable Color Code:**

Green .....+ Excitation  
Black.....- Excitation  
White .....+ Signal  
Red .....- Signal

**Warranty:**  
Two-year limited warranty

## Dimensions

RATED CAPACITY	C	C1	C2	H	H1	H2	H3	L	L1	L2	L3	L4	W	W1	T
<b>lb/inches</b>															
35,000	1.31	1.50	2.12	3.22	.95	.37	2.75	12.50	1.50	3.50	6.25	5.84	2.75	2.00	10-32 x .50 DP
<b>kg/mm</b>															
15,875.7	33.3	38.1	53.9	69.9	24.1	9.4	—	317.5	38.1	88.9	158.8	152.4	69.9	50.8	10-32 x 12.7 DP

## Order Information

LOAD RATING	PART #	PRICE
<b>RLSB2L</b>		
*35,000 lb (15,875.7 kg)	65234	\$1,595.00

\* Hermetically sealed

## Interchangeable Products

MANUFACTURER	MODEL	CAPACITY
Masstron	ML4437	35,000 lb (15,875.7 kg)

# RL50210

Single-Ended Beam, Alloy Steel, IP65

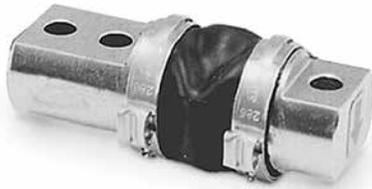

Picture is a representation of actual product

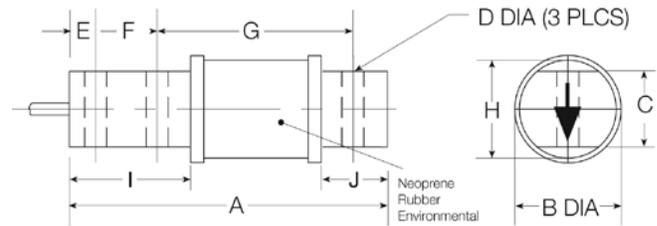

## Specifications

### Full Scale Output:

3.0 mV/V

### Output Resistance:

349-355 ohms

### Input Resistance:

380-450 ohms

### Material/Finish:

High-alloy steel, nickel plated

### Temperature:

Operating range  
0°F to 150°F/-18°C to 65°C

### Safe Overload:

150% Full scale

### Rated Excitation:

10V DC (15V maximum)

### Nonlinearity:

0.03% Full scale

### Hysteresis:

0.02% Full scale

### Insulation Resistance:

5000 megohms

### Deflection at Capacity:

25-50 lb=.008 in/.20 mm,  
100 lb=.010 in/.25 mm,  
150 lb=.012 in/.30 mm,  
250 lb=.016 in/.41 mm,  
500 lb=.025 in/.64 mm

### Seal Type:

Environmentally sealed with neoprene sleeve, IP65

### Cable Length:

20 ft/6.1 m

### Cable Diameter:

.200 polyurethane jacket

### Cable Color Code:

Red .....+ Excitation  
Black.....- Excitation  
Green .....+ Signal  
White .....- Signal

### Warranty:

Two-year limited warranty

### Approvals:



## Dimensions

RATED CAPACITY	A	B	C	D	E	F	G	H	I	J
<b>lb/inches</b>										
25-500	2.81	1.30	.62	.26	.25	.50	0.25	1.00	1.00	.50
<b>kg/mm</b>										
11.3-226.8	71.4	33.0	15.8	6.6	6.4	12.7	6.35	25.4	25.4	12.7

## Order Information

LOAD RATING		PART #	PRICE
25 lb	(11.3 kg)	17385	\$245.00
50 lb	(22.7 kg)	17380	245.00
100 lb	(45.4 kg)	17381	245.00
150 lb	(68.0 kg)	17382	245.00
250 lb	(113.4 kg)	17383	245.00
500 lb	(226.8 kg)	17384	245.00

## Interchangeable Products

MANUFACTURER	MODEL
VPG Scentroidronics	60040
Artech®	50210
VPG Revere Transducers	5503

## Weigh Module Available

MANUFACTURER	MODEL
Rice Lake Weighing Systems	RL50210



# RL50210SS

Single-Ended Beam, Stainless Steel, IP67



Picture is a representation of actual product

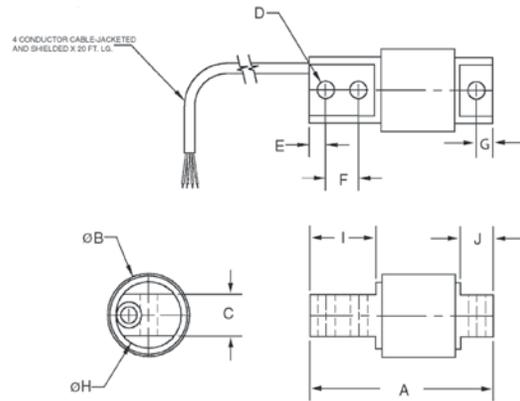

## Specifications

<b>Full Scale Output:</b> 3.0mV/V	<b>Rated Excitation:</b> 10V DC (15V maximum)	<b>Deflection at Capacity:</b> 25-50 lb=.008 in/.20 mm, 100 lb=.010 in/.25 mm, 150 lb=.012 in/.30 mm, 250 lb=.016 in/.41 mm, 500 lb=.025 in/.64 mm	<b>Cable Diameter:</b> .200 PVC jacket
<b>Bridge Resistance:</b> 350 ohms, nominal	<b>Nonlinearity:</b> 0.03% Full scale	<b>Seal Type:</b> Environmentally sealed stainless steel sleeve, IP67	<b>Cable Color Code:</b> Red .....+ Excitation Black.....- Excitation Green.....+ Signal White .....- Signal
<b>Material/Finish:</b> Stainless steel	<b>Hysteresis:</b> 0.05% Full scale	<b>Cable Length:</b> 20 ft/6.1 m	<b>Warranty:</b> Two-year limited warranty
<b>Temperature:</b> Operating range 0°F to 150°F/-18°C to 65°C	<b>Insulation Resistance:</b> 5000 megohms		<b>Approvals:</b> 
<b>Safe Overload:</b> 150% Full scale			

## Dimensions

RATED CAPACITY	A	B	C	D	E	F	G	H	I	J
<b>lb/inches</b>										
25-500	2.81	1.30	.62	.26	.25	.50	1.81	1.00	1.00	.50
<b>kg/mm</b>										
11.3-226.8	71.4	33.0	15.8	6.6	6.4	12.7	46.0	25.4	25.4	12.7

## Order Information

LOAD RATING	PART #	PRICE
25 lb (11.3 kg)	53209	\$425.00
50 lb (22.7 kg)	53210	425.00
75 lb (34.0 kg)	53211	425.00
100 lb (45.4 kg)	53212	425.00
150 lb (68.0 kg)	53213	425.00
250 lb (113.4 kg)	53214	425.00
500 lb (226.8 kg)	53215	425.00

## Interchangeable Products

MANUFACTURER	MODEL
VPG Sensortronics	60040
Artech®	50210
VPG Revere Transducers	5503

## Weigh Module Available

MANUFACTURER	MODEL
Rice Lake Weighing Systems	RL50210

# RL60040SST

Single-Ended Beam, Stainless Steel, IP65



Picture is a representation of actual product

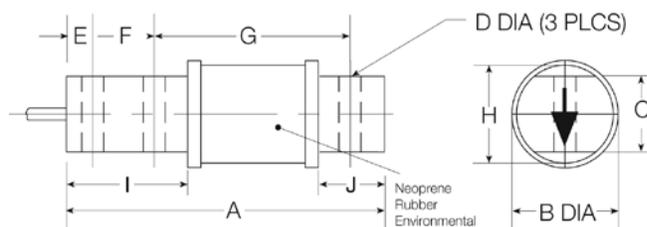

## Specifications

**Full Scale Output:**

3.0 mV/V

**Output Resistance:**

349-355 ohms

**Input Resistance:**

380-450 ohms

**Material/Finish:**

Stainless steel

**Temperature:**Operating range  
0°F to 150°F/-18°C to 65°C**Safe Overload:**

150% Full scale

**Rated Excitation:**

10V DC (15V maximum)

**Nonlinearity:**

0.03% Full scale

**Hysteresis:**

0.02% Full scale

**Insulation Resistance:**

5000 megohms

**Deflection at Capacity:**25-50 lb=.008 in/.20 mm,  
100 lb=.010 in/.25 mm,  
150 lb=.012 in/.3 mm,  
250 lb=.016 in/.41 mm,  
500 lb=.025 in/.64 mm**Seal Type:**Environmentally sealed with neoprene  
sleeve, IP65**Cable Length:**

20 ft/6.1 m

**Cable Diameter:**

.200 polyurethane jacket

**Cable Color Code:**Red .....+ Excitation  
Black.....- Excitation  
Green .....+ Signal  
White .....- Signal**Warranty:**

Two-year limited warranty

## Dimensions

RATED CAPACITY	A	B	C	D	E	F	G	H	I	J
<b>lb/inches</b>										
25-500	2.81	1.30	.62	.26	.25	.50	1.81	1.00	1.00	.50
<b>kg/mm</b>										
11.3-226.8	71.4	33.0	15.8	6.6	6.4	12.7	46.0	25.4	25.4	12.7

## Order Information

LOAD RATING		PART #	PRICE
25 lb	(11.3 kg)	101972	\$425.00
50 lb	(22.7 kg)	101973	425.00
75 lb	(34.0 kg)	101974	425.00
100 lb	(45.4 kg)	101975	425.00
150 lb	(68.0 kg)	101976	425.00
250 lb	(113.4 kg)	101977	425.00
500 lb	(226.8 kg)	101978	425.00

## Interchangeable Products

MANUFACTURER	MODEL
*VPG Sensortronics	60040
*Artech®	50210
*VPG Revere Transducers	5503

## Weigh Module Available

MANUFACTURER	MODEL
Rice Lake Weighing Systems	RL50210

\*Alloy steel

# RL40BBS

Single-Ended Beam , Alloy Steel, IP65



Picture is a representation of actual product

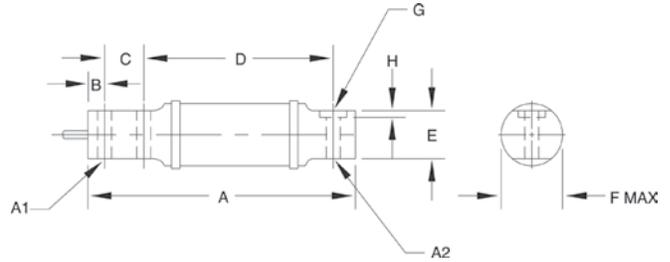

## Specifications

**Full Scale Output:**  
2.0mV/V

**Bridge Resistance:**  
50-1000 lb/750 ohms, nominal  
2500 lb/347 ohms, nominal

**Material/Finish:**  
High-alloy steel, nickel plated

**Temperature:**  
Operating range  
0°F to 150°F/-18°C to 65°C

**Safe Overload:**  
150% Full scale

**Rated Excitation:**  
10V DC (15V maximum)

**Deflection at Capacity:**  
50 lb=.015 in/.38 mm,  
100 lb=.005 in/.64 mm,  
200-250 lb=.030 in/.76 mm,  
500 lb=.020 in/.51 mm,  
1000 lb=.040 in/1.02 mm,  
2500 lb=.120 in/3.05 mm

**Nonlinearity:**  
0.03% Full scale

**Hysteresis:**  
0.02% Full scale

**Insulation Resistance:**  
5000 megohms

**Seal Type:**  
Environmentally sealed with neoprene sleeve, IP65

**Cable Length:**  
10 ft/3.1 m

**Cable Diameter:**  
.200 polyurethane jacket

**Cable Color Code:**

Green .....+ Excitation  
Black .....- Excitation  
White .....+ Signal  
Red .....- Signal

**Warranty:**  
Two-year limited warranty

**Approvals:**



## Dimensions

RATED CAPACITY	A	A1	A2	B	C	D	E	F	G	H
<b>lb/inches</b>										
50-100	6.00	.31	.31	.38	.88	4.25	1.06	1.41	—	—
200-1000	6.62	.52	.52	.50	1.12	4.25	1.06	1.41	—	—
2500	11.38	.53	.62	.50	1.75	8.25	1.25	2.19	1.19	.12
<b>kg/mm</b>										
22.7-45.4	52.4	7.9	7.9	9.7	22.4	108.0	26.9	35.8	—	—
90.7-453.6	168.2	13.2	13.2	12.7	28.5	108.0	26.9	35.8	—	—
1134.0	289.1	13.5	15.8	12.7	44.5	209.6	31.8	55.6	30.3	3.0

## Order Information

LOAD RATING		PART #	PRICE
50 lb	(22.7 kg)	17395	\$395.00
100 lb	(45.4 kg)	17343	395.00
200 lb	(90.7 kg)	17396	395.00
250 lb	(113.4 kg)	17397	395.00
500 lb	(226.8 kg)	17398	395.00
1000 lb	(453.6 kg)	17344	395.00
2500 lb	(1134.0 kg)	17345	625.00

## Interchangeable Products

MANUFACTURER	MODEL
HBM®	BBS
VPD Sensortronics	65087
Fairbanks®	3-481XX-1
Fairbanks	3-48660-1
ARTECH	40310

# RLHBB

Single-Ended Beam, Stainless Steel, NTEP 1:4000 Class III Single Cell 1:5000 Class III Mult/ Cell, OIML C3



Picture is a representation of actual product

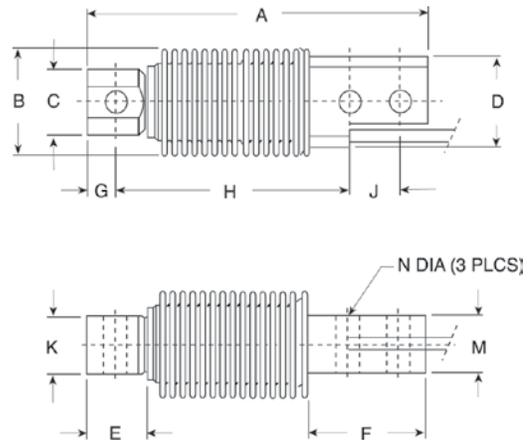

## Specifications

<b>Full Scale Output:</b> 2.0 mV/V	<b>Safe Overload:</b> 150% Full scale	<b>Seal Type:</b> Hermetically sealed, IP68	<b>Cable Diameter:</b> .220 polyurethane jacket
<b>Output Resistance:</b> 355 ohms, +/- 5	<b>Rated Excitation:</b> 10V DC (15V maximum)	<b>Cable Color Code:</b> Blue .....+ Excitation Black.....- Excitation White .....+ Signal Red .....- Signal Green .....+ Sense Gray .....- Sense	<b>Warranty:</b> Two-year limited warranty
<b>Input Resistance:</b> 380 ohms, +/- 10	<b>Total Error:</b> 0.02% Full scale	<b>Cable Length:</b> 3 m/10 ft	<b>Approvals:</b> 
<b>Material/Finish:</b> Stainless steel	<b>Insulation Resistance:</b> 2000 megohms		
<b>Temperature:</b> Compensated range 14°F to 104°F/-10°C to 40°C	<b>Deflection at Capacity:</b> 5-500 kg ≤ .4 mm/.015 in		

## Dimensions

RATED CAPACITY	A	B	C	D	E	F	G	H	J	K	M	N
<b>lb/inches</b>												
11.0-1102.3	4.72	1.61	.91	1.26	.81	1.79	.39	3.23	.71	.79	.79	.32
<b>kg/mm</b>												
5-500	120.0	40.0	23.0	32.0	20.5	45.5	10.0	82.0	18.0	20.0	20.0	8.20

## Order Information

LOAD RATING	PART #	PRICE
<b>OIML</b>		
5 kg (11.0 lb)	32678	\$525.00
10 kg (22.0 lb)	32677	525.00
20 kg (44.1 lb)	31259	525.00
50 kg (110.2 lb)	31260	525.00
100 kg (220.5 lb)	31261	525.00
200 kg (441.0 lb)	31262	525.00
250 kg (551.2 lb)	31263	525.00
500 kg (1102.5 lb)	36462	525.00
<b>NTEP</b>		
5 kg (11.0 lb)	41113	525.00
10 kg (22.0 lb)	41114	525.00
20 kg (44.1 lb)	41115	525.00
50 kg (110.2 lb)	41116	525.00
100 kg (220.5 lb)	41117	525.00
200 kg (441.0 lb)	41118	525.00
250 kg (551.2 lb)	41119	525.00
500 kg (1102.5 lb)	41120	525.00

## Interchangeable Products

MANUFACTURER	MODEL
HBM®	Z6*
VPG Revere Transducers	SHB
VPG Tedeá-Huntleigh	355
VPG Celtron	HBB**
Cardinal®	CB6

## Weigh Module Available

MANUFACTURER	MODEL
Rice Lake Weighing Systems	1700E Series

\*Non-NTEP

\*\*Non-NTEP, not FM-approved

# RL32011WB-L

Single-Ended Beam, NTEP 1:5000 Class III, Multiple Cell, Stainless Steel, IP67



Picture is a representation of actual product

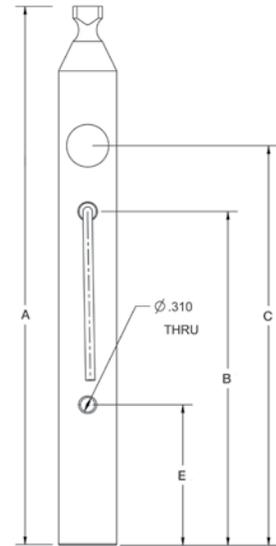
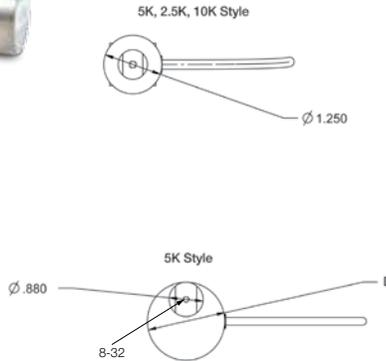

## Specifications

**Full Scale Output:**

2.0mV/V +/- 0.1%

**Output Resistance:**

350 ohms +/- 3

**Input Resistance:**

385 ohms +/- 10 ohms

**Material/Finish:**

Stainless steel

**Temperature:**

Compensated range  
14°F to 104°F/-10°C to 40°C

**Safe Overload:**

150% full scale

**Safe Sideload:**

100% full scale

**Rated Excitation:**

10 VDC

**Combined Error:**

0.02% full scale

**Non-Repeatability:**

+/- 0.01% full scale

**Insulation Resistance:**

5000 megaohms

**Cable Color Code:**

Green .....+ Excitation  
Black.....- Excitation  
White .....+ Signal  
Red .....- Signal

**Seal Type:**

Potted, IP67

**Cable Length:**

20 ft/6.1 m

**Cable Diameter:**

.190 polyurethane jacket

**Warranty:**

Two-year limited warranty

**Approvals:**



## Dimensions

RATED CAPACITY	A	B	C	D	E
<b>lb/inches</b>					
1250 lb	11.0	7.1	8.5	1.25	3.0
2500 lb	11.0	8.5	8.4	1.62	3.0
5000 lb	10.9	5.5	7.4	2.0	3.0
10,000 lb	12.6	5.9	8.0	2.5	3.0
<b>kg/mm</b>					
567.0 kg	292.1	180.9	216.5	31.8	76.2
1134.0 kg	292.1	215.3	212.9	41.1	76.2
2268.0 kg	276.9	138.8	187.5	50.8	76.2
4535.9 kg	320.5	149.6	203.2	63.5	76.2

## Order Information

LOAD RATING	PART #	PRICE	
1250 lb	566.99 kg	119788	\$595.00
2500 lb	1134.0 kg	119789	595.00
5000 lb	2268.0 kg	119790	895.00
10,000 lb	4535.9 kg	119791	995.00

## Interchangeable Products

MANUFACTURER	MODEL
Avery Weigh Tronix	—
Rice Lake Weighing Systems	75000 SS

# RL32011WB-T

Single-Ended Beam, NTEP 1:5000 Class III, Multiple Cell, Stainless Steel, IP67



Picture is a representation of actual product

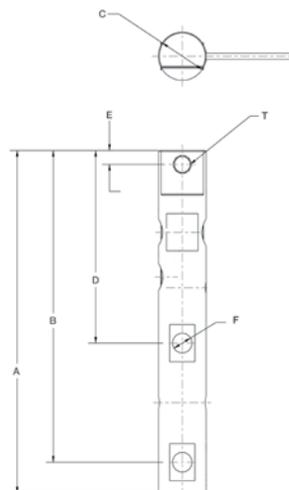

## Specifications

**Full Scale Output:**

2.0 mV/V +/- 0.1%

**Output Resistance:**

350 ohms +/- 3

**Input Resistance:**

385 ohms +/- 10 ohms

**Material/Finish:**

Stainless steel

**Temperature:**

Compensated range  
14°F to 104°F/-10°C to 40°C

**Safe Overload:**

150% full scale

**Safe Sideload:**

100% full scale

**Rated Excitation:**

10 VDC

**Combined Error:**

0.02% full scale

**Non-Repeatability:**

+/- 0.01% full scale

**Insulation Resistance:**

5000 megaohms

**Cable Color Code:**

Green .....+ Excitation

Black .....- Excitation

White .....+ Signal

Red .....- Signal

**Seal Type:**

Potted, IP67

**Cable Length:**

20 ft/6.1 m

**Cable Diameter:**

.190 polyurethane jacket

**Warranty:**

Two-year limited warranty

**Approvals:**

## Dimensions

RATED CAPACITY	A	B	C	D	E	F	T
<b>lb/inches</b>							
1250 lb	11.50	10.47	1.25	6.47	.470	0.53	1/2-13 UNC
2500 lb	11.50	10.47	1.62	6.47	.9.470	0.66	5/8-11 UNC
<b>kg/mm</b>							
566.99 kg	292.1	265.9	31.75	164.3	24.6	13.46	—
1134.0 kg	292.1	265.9	41.14	164.3	24.6	16.76	—

## Order Information

LOAD RATING		PART #	PRICE
1250	(566.99 kg)	119796	\$595.00
2500	(1134.0 kg)	119797	595.00

## Interchangeable Products

MANUFACTURER	MODEL
Avery Weigh Tronix	—

# RL70000

Double-Ended Beam , Alloy Steel, NTEP 1:10,000 Class III L Multiple Cell, IP67



Picture is a representation of actual product

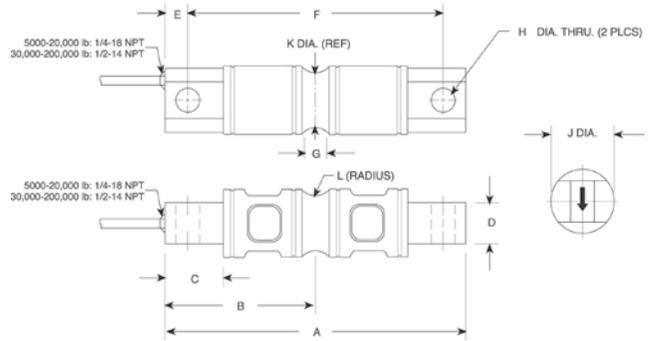

LOAD CELLS

## Specifications

**Full Scale Output:**

3.0mV/V

**Output Resistance:**

700 ohms, +/- 5

**Input Resistance:**

770 ohms, +/- 10

**Material/Finish:**

High-alloy steel, nickel plated

**Temperature:**

Compensated range  
14°F to 104°F/-10°C to 40°C

**Safe Overload:**

150% Full scale

**Safe Sideload:**

100% Full scale

**Rated Excitation:**

10V DC (15V maximum)

**Combined Error:**

0.02% Full scale

**Insulation Resistance:**

5000 megohms

**Seal Type:**

Environmentally sealed, IP67

**Deflection at Capacity:**

5000 lb=.02 in/.5 mm,  
10,000 lb=.025 in/.6 mm,  
20,000 lb=.042 in/1.1 mm,  
30,000-50,000 lb=.02 in/.5 mm,  
60,000 lb=.025 in/.6 mm,  
100,000 lb=.02 in/.5 mm

**Cable Length:**

30 ft/9.1 m

**Cable Diameter:**

.200 5k-20k; .305 30k-250k

**Cable Color Code:**

Red .....+ Excitation  
Black .....- Excitation  
Green .....+ Signal  
White .....- Signal

**Warranty:**

Two-year limited warranty

**Approvals:**



## Dimensions

RATED CAPACITY	A	B	C	D	E	F	G	H	J	K	L
<b>lb/inches</b>											
5000-10,000	8.12	4.06	1.44	1.12	.62	6.88	.62	.66	1.70	1.48	.50
20,000	8.12	4.06	1.44	1.12	.62	6.88	.84	.66	1.95	1.48	.50
30,000-60,000	10.25	5.12	1.88	2.37	.88	8.50	1.00	1.06	3.20	2.73	1.00
100,000	11.25	5.62	1.88	2.50	.88	9.50	1.00	1.06	3.50	3.24	1.00
150,000	11.25	5.62	1.88	2.80	.88	9.50	1.25	1.06	3.90	3.64	1.50
200,000-250,000	16.10	8.05	3.05	4.60	1.55	13.00	1.30	1.56	5.38	5.17	2.00
<b>kg/mm</b>											
2268.0-9071.9	206.3	103.1	36.6	28.5	15.8	174.8	15.8	16.8	55.9	37.6	12.7
9071.9	206.3	103.1	36.6	14.2	21.3	174.8	21.3	16.8	52.8	37.6	12.7
13,607.8-27,215.6	260.4	130.1	47.8	60.2	22.4	215.9	25.4	26.9	81.3	69.3	25.4
45,359.4	285.8	142.8	47.8	63.5	22.4	241.3	25.4	26.9	88.9	82.3	25.4
68,038.8	285.8	142.8	47.8	71.1	22.4	241.3	31.8	26.9	99.1	92.5	38.1
90,718.5-113,398	409.0	204.5	77.5	116.8	39.4	330.2	33.0	39.6	136.7	131.3	50.8

## Order Information

LOAD RATING	PART #	PRICE
<b>NTEP</b>		
5000 lb (2268.0 kg)	36263	\$655.00
10,000 lb (4535.9 kg)	36264	655.00
20,000 lb (9071.9 kg)	36265	655.00
30,000 lb (13,607.8 kg)	36266	755.00
40,000 lb (18,143.7 kg)	36267	755.00
50,000 lb (22,679.6 kg)	36268	755.00
60,000 lb (27,215.5 kg)	36269	755.00
100,000 lb (45,359.2 kg)	36270	1,475.00
150,000 lb (68,038.8 kg)	36976	1,475.00
200,000 lb (90,718.5 kg)	36977	2,775.00
<b>Non-NTEP</b>		
250,000 lb (113,398.0 kg)	36978	2,775.00

## Interchangeable Products

MANUFACTURER	MODEL
VPG Revere Transducers	5103
Artech®	70210
Mettler Toledo	SLD 430
Celtron	CSB

## Weigh Module Available

MANUFACTURER	MODEL
Rice Lake Weighing Systems	EZ Mount 1

www.ricelake.com | Phone: 800-472-6703

RICE LAKE

# RL70000 SS

Double-Ended Beam, Stainless Steel, NTEP 1:5000 Class III/1:10,000 III L Multiple Cell, IP67



Picture is a representation of actual product

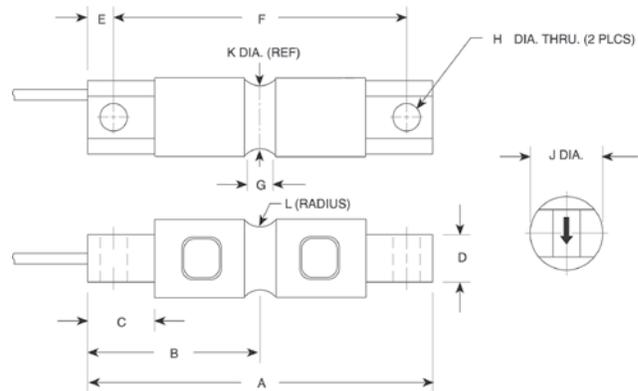

## Specifications

### Full Scale Output:

3.0mV/V

### Output Resistance:

700 ohms, +/- 9

### Input Resistance:

Ohms, 700 +/- 7

### Material/Finish:

Stainless steel

### Temperature:

Compensated range  
0°F to 150°F/-18°C to 65°C

### Safe Overload:

150% Full scale

### Safe Sideload:

100% Full scale

### Rated Excitation:

10V AC/DC (15V max)

### Non-repeatability:

0.02% Full scale

### Combined Error:

0.3% Full scale

### Insulation Resistance:

5000 megohms

### Deflection at Capacity:

5000 lb=.02 in/.5 mm,  
10,000 lb=.025 in/.6 mm,  
20,000 lb=.042 in/1.1 mm,  
30,000-50,000 lb=.02 in/.5 mm,  
60,000 lb=.025 in/.6 mm,  
100,000-150,000 lb=.02 in/.5 mm

### Seal Type:

Environmentally sealed, IP67

### Cable Length:

18.6 ft/6 m (5K - 20K)  
30'/10 m (30K - 150K)

### Cable Diameter:

.295

### Cable Color Code:

Red .....+ Excitation  
Black.....- Excitation  
Green.....+ Signal  
White .....- Signal  
Orange.....Shield

### Warranty:

Two-year limited warranty

### Approvals:



Except  
5k and 150k

## Dimensions

RATED CAPACITY	A	B	C	D	E	F	G	H	J	K	L
<b>lb/inches</b>											
5000-10,000	8.12	4.06	1.44	1.12	.62	6.88	.62	.66	1.70	1.48	.50
20,000	8.12	4.06	1.44	1.12	.62	6.88	.84	.66	1.95	1.48	.50
30,000-60,000	10.25	5.12	1.88	2.37	.88	8.50	1.00	1.06	3.20	2.73	1.00
100,000	11.25	5.62	1.88	2.50	.88	9.50	1.00	1.06	3.50	3.24	1.50
150,000	11.25	5.62	1.88	2.80	.88	9.50	1.25	1.06	3.90	3.64	1.50
<b>kg/mm</b>											
2268.0-4535.9	206.3	103.1	36.6	28.5	15.8	174.8	15.8	16.8	43.2	37.6	12.7
9071.9	206.3	103.1	36.6	14.2	15.8	174.8	21.3	16.8	49.5	37.6	12.7
13,607.8-27,215.6	260.4	130.1	47.8	60.2	22.4	215.9	25.4	26.9	81.3	69.3	25.4
45,359.4	285.8	142.8	47.8	63.5	22.4	241.3	25.4	26.9	88.9	82.3	38.1
68,038.8	285.8	142.8	47.8	71.1	22.4	241.3	31.8	26.9	99.1	92.5	38.1

## Order Information

LOAD RATING		PART #	PRICE
***5000 lb	(2268.0 kg)	30431	\$700.00
10,000 lb	(4535.9 kg)	30432	750.00
20,000 lb	(9071.9 kg)	30433	750.00
30,000 lb	(13,607.8 kg)	30434	825.00
40,000 lb	(18,143.7 kg)	30435	825.00
50,000 lb	(22,679.6 kg)	30436	925.00
60,000 lb	(27,215.5 kg)	30437	925.00
100,000 lb	(45,359.2 kg)	30444	1,825.00
***150,000 lb	(68,038.9 kg)	30445	1,895.00
<b>Conduit Adapter Kit*(must be factory installed to maintain warranty)</b>			
3/8-24 to 1/4-18 NPT		31534*	30.00
5/8-18 UNF / 1/2-14 NPT		31535**	30.00

\*\*\*Non-NTEP

## Interchangeable Products

MANUFACTURER	MODEL
Rice Lake Weighing Systems	RL71000HE
VPG Revere Transducers	9103
Mettler Toledo	SLD-530

\* On capacities of 5000 to 20,000 lb, order part #31534

\*\* On capacities of 30,000 to 150,000 lb, order part #31535

## Weigh Module Available

MANUFACTURER	MODEL
Rice Lake Weighing Systems	EZ Mount 1



# RL71000 HE

Double-Ended Beam, Stainless Steel, Hermetically Sealed, IP66/68



Picture is a representation of actual product

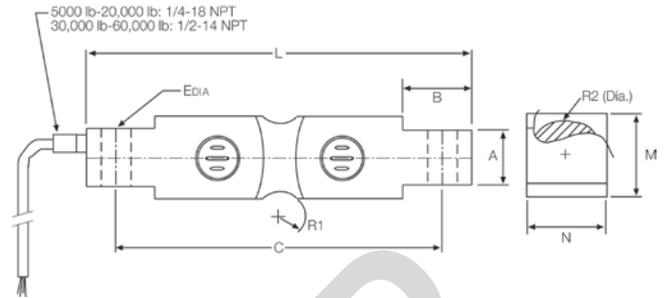

## Specifications

<b>Full Scale Output:</b> 3.0mV/V	<b>Safe Overload:</b> 200% Full scale	<b>Hysteresis:</b> 0.05% Full scale	<b>Seal Type:</b> Hermetically sealed, IP66/68
<b>Bridge Resistance:</b> 700 ohms, nominal with voltage applied*	<b>Side Load:</b> 100% Full scale	<b>Insulation Resistance:</b> 5000 megohms	<b>Cable Length:</b> 25ft/7.6 m
<b>Material/Finish:</b> Stainless steel	<b>Rated Excitation:</b> 6-15V DC	<b>Cable Color Code:</b> Red .....+ Excitation Black.....- Excitation Green .....+ Signal White .....- Signal Orange.....Shield	<b>Warranty:</b> Two-year limited warranty
<b>Temperature:</b> Operating range 0°F to 150°F/-18°C to 65°C	<b>Nonlinearity:</b> 0.03% Full scale		<b>Approvals:</b> 

## Dimensions

RATED CAPACITY	A	B	C	E	R1	R2 (DIA.)	L	M	N
<b>lb/inches</b>									
30,000-60,000	2.38	1.88	8.50	1.06	1.00	2.73	10.25	3.03	3.03
<b>kg/mm</b>									
13,608-27,216	60.4	47.7	215.9	26.9	25.4	69.3	260.3	76.96	76.96

## Order Information

LOAD RATING		PART #	PRICE
30,000 lb	(13,608.0 kg)	42134	\$1,695.00
50,000 lb	(22,679.6 kg)	42136	1,695.00
60,000 lb	(27,216.0 kg)	42137	1,695.00

\*Consult factory for IS applications

# RL72010MH

Double-Ended Beam, Stainless Steel, Hermetically Sealed, IP68



Picture is a representation of actual product

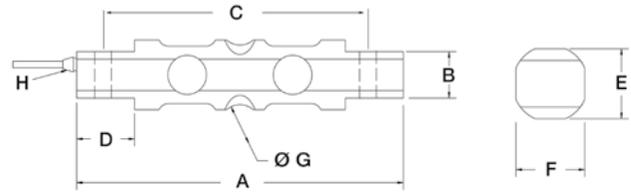

## Specifications

### Full Scale Output:

3.0 mV/V, nominal

### Bridge Resistance:

700 ohms, nominal

### Material/Finish:

Stainless steel

### Temperature:

Compensated range  
0°F to 150°F/-18°C to 65°C

### Safe Overload:

150% Full scale

### Sideload:

100% Full scale

### Non Linearity:

0.03% Full scale

### Hysteresis:

0.05% Full scale

### Rated Excitation:

5-15 VDC

### Insulation Resistance:

5000 mega ohms

### Cable Diameter:

.190 Polyurethane jacket

### Cable Color Code:

Red .....+ Excitation  
Black.....- Excitation  
Green .....+ Signal  
White .....- Signal  
Orange.....Shield

### Seal Type:

Hermetically sealed, IP68

### Cable Length:

25 ft/7.6 m

### Warranty:

Two-year limited warranty

### Approvals:



## Dimensions

RATED CAPACITY	A	B	C	D	E	F	ØG	H
<b>lb/inches</b>								
5000-20,000	8.12	1.14	6.88	1.44	1.71	1.71	1.00	1/4-18 NPT
30,000-60,000	10.25	2.38	8.50	1.88	3.03	3.03	2.00	1/2-14 NPT
<b>kg/mm</b>								
2268-9072	206.2	28.9	174.7	36.5	43.43	43.43	25.4	1/4-18 NPT
13,608-27,216	260.3	60.4	215.9	47.7	76.96	76.96	50.8	1/2-14 NPT

## Order Information

LOAD RATING	PART #	PRICE
5000 lb (2268.0 kg)	118462	\$1,095.00
10,000 lb (4535.9 kg)	118463	1,095.00
20,000 lb (9071.9 kg)	118464	1,095.00
30,000 lb (13,607.8 kg)	118465	1,495.00
40,000 lb (18,143.7 kg)	118466	1,495.00
50,000 lb (22,679.6 kg)	118467	1,495.00
60,000 lb (27,215.5 kg)	118468	1,495.00

## Interchangeable Products

MANUFACTURER	MODEL
Rice Lake Weighing Systems	RL71000HE
Rice Lake Weighing Systems	RL70000SS
VPG Revere Transducers	9103

## Weigh Module Available

MANUFACTURER	MODEL
Rice Lake Weighing Systems	EZ Mount 1

# RL75016

Double-Ended Beam, Alloy Steel, IP67



Picture is a representation of actual product

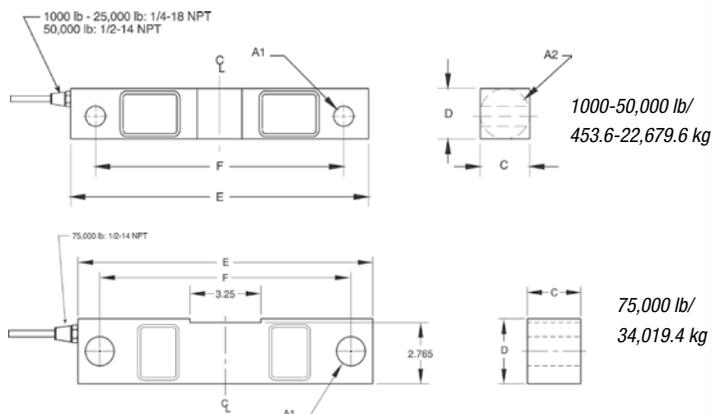

## Specifications

**Full Scale Output:**  
3.0mV/V

**Output Resistance:**  
700 ohms, +/- 5

**Input Resistance:**  
770 ohms, +/- 10

**Material/Finish:**  
High-alloy steel, nickel plated

**Temperature:**  
Operating range  
0°F to 150°F/-18°C to 65°C

**Safe Overload:**  
150% Full scale

**Safe Sideload:**  
100% Full scale

**Rated Excitation:**  
10V DC (15V maximum)

**Nonlinearity:**  
0.03% Full scale

**Deflection at Capacity:**  
1000-3000 lb=.01 in/.3 mm,  
5000 lb=.015 in/.4 mm  
10,000-20,000 lb=.022 in/.6 mm,  
25,000 lb=.036 in/.9 mm  
50,000 lb=.052 in/1.3 mm,  
75,000 lb=.07 in/1.8 mm

**Hysteresis:**  
0.02% Full scale

**Insulation Resistance:**  
5000 megohms

**Seal Type:**  
Environmentally sealed, IP67

**Cable Length:**  
25 ft/7.6 m

**Cable Diameter:**  
.200 polyurethane jacket 1K-25K  
.305 polyurethane jacket 50K-75K

**Cable Color Code:**

Red .....+ Excitation  
Black.....- Excitation  
Green .....+ Signal  
White .....- Signal

**Warranty:**  
Two-year limited warranty

**Approvals:**



## Dimensions

RATED CAPACITY	A1	A2	C	D	E	F
<b>lb/inches</b>						
1000-5000	.50	1.25	1.25	1.25	7.50	6.25
10,000-25,000	.81	1.99	1.44	1.94	8.75	7.50
50,000	1.31	3.00	2.44	2.94	13.50	11.50
75,000	1.31	—	2.44	2.94	13.50	11.50
<b>kg/mm</b>						
453.6-2268.0	12.7	31.8	31.8	31.8	190.5	158.8
4535.9-11,339.8	20.6	50.8	36.6	49.3	222.3	190.5
22,679.6	33.3	76.2	62.0	74.7	342.9	292.1
34,019.4	33.3	—	62.0	74.7	342.9	292.1

## Order Information

LOAD RATING		PART #	PRICE
1000 lb	(453.6 kg)	17300	\$525.00
1500 lb	(680.4 kg)	17302	525.00
2000 lb	(907.2 kg)	17304	525.00
2500 lb	(1134.0 kg)	17306	525.00
3000 lb	(1360.8 kg)	17308	525.00
5000 lb	(2268.0 kg)	17309	525.00
10,000 lb	(4535.9 kg)	17311	600.00
15,000 lb	(6803.9 kg)	17313	600.00
20,000 lb	(9071.9 kg)	17315	600.00
25,000 lb	(11,339.8 kg)	17317	600.00
50,000 lb	(22,679.6 kg)	17319	925.00
*75,000 lb	(34,019.4 kg)	25357	925.00

\*75,000 lb capacity has a square center

## Interchangeable Products

MANUFACTURER	MODEL
VPG Celtron	DSR
VPG Sensortronics	65016
VPG Revere Transducers	5203

## Weigh Module Available

MANUFACTURER	MODEL
Rice Lake Weighing Systems	RL1600 Series

# RL75016 SS

Double-Ended Beam, Stainless Steel, IP67



Picture is a representation of actual product

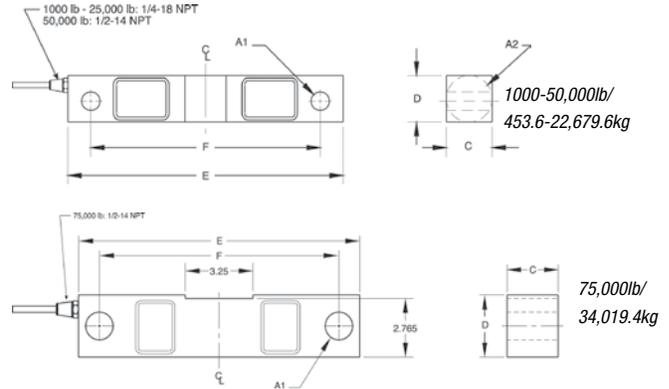

## Specifications

### Full Scale Output:

3.0 mV/V

### Output Resistance:

700 ohms, +/- 5

### Input Resistance:

770 ohms, +/- 10

### Material/Finish:

Stainless steel

### Temperature:

Operating range  
0°F to 150°F/-18°C to 65°C

### Safe Overload:

150% Full scale

### Safe Sideload:

100% Full scale

### Rated Excitation:

10V DC (15V maximum)

### Nonlinearity:

0.07% Full scale

### Hysteresis:

0.02% Full scale

### Deflection at Capacity:

1000-3000 lb=.01 in/.3 mm,  
5000 lb=.015 in/.4 mm  
10,000-20,000 lb=.022 in/.6 mm,  
25,000 lb=.036 in/.9 mm  
50,000 lb=.052 in/1.3 mm,  
75,000 lb=.07 in/1.8 mm

### Insulation Resistance:

5000 megohms

### Seal Type:

Environmentally sealed, IP67

### Cable Length:

25 ft/7.6 m

### Cable Diameter:

.200 polyurethane jacket 1 k-25 k  
.305 polyurethane jacket 50 k-75 k

### Cable Color Code:

Red .....+ Excitation  
Black.....- Excitation  
Green .....+ Signal  
White .....- Signal

### Warranty:

Two-year limited warranty

### Approvals:



## Dimensions

RATED CAPACITY	A1	A2	C	D	E	F
<b>lb/inches</b>						
1000-5000	.50	1.25	1.25	1.25	7.50	6.25
10,000-25,000	.81	1.99	1.44	1.94	8.75	7.50
50,000	1.31	3.00	2.44	2.94	13.50	11.50
75,000	1.31	—	2.44	2.94	13.50	11.50
<b>kg/mm</b>						
453.6-2268.0	12.7	31.8	31.8	31.8	190.5	158.8
4535.9-11,339.8	20.6	50.8	36.6	49.3	222.3	190.5
22,679.6	33.3	76.2	62.0	74.7	342.9	292.1
34,019.4	33.3	—	62.0	74.7	342.9	292.1

## Order Information

LOAD RATING	PART #	PRICE
1000 lb (453.6 kg)	17301	\$550.00
1500 lb (680.4 kg)	17303	550.00
2000 lb (907.2 kg)	17305	550.00
2500 lb (1134.0 kg)	17307	550.00
5000 lb (2268.0 kg)	17310	550.00
10,000 lb (4535.9 kg)	17312	625.00
15,000 lb (6803.9 kg)	17314	625.00
20,000 lb (9071.9 kg)	17316	625.00
25,000 lb (11,334.8 kg)	17318	625.00
50,000 lb (22,679.6 kg)	17320	1,225.00
*75,000 lb (34,019.4 kg)	25356	1,225.00

\*75,000 lb capacity has a square center

## Interchangeable Products

MANUFACTURER	MODEL
Rice Lake Weighing Systems	RL75016 WHE*
VPG Scentroid	65016W
VPG Scentroid	65016WH*
VPG Revere Transducers	9203
VPG Celtron	DSR-HSS

## Weigh Module Available

MANUFACTURER	MODEL
Rice Lake Weighing Systems	RL1600 Series

\*Hermetically sealed

# RL75016 WHE

Double-Ended Beam, Stainless Steel, Hermetically Sealed, IP66/68



Picture is a representation of actual product

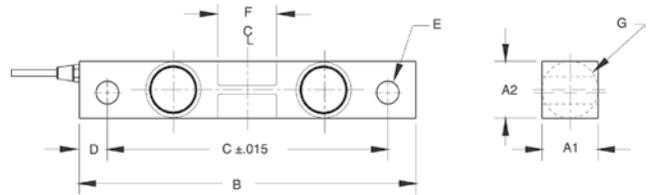

## Specifications

**Full Scale Output:**  
3.0mV/V

**Output Resistance:**  
699-707 ohms

**Input Resistance:**  
686-714 ohms

**Material/Finish:**  
Stainless steel

**Temperature:**  
Operating range  
0°F to 150°F/-18°C to 65°C

**Safe Overload:**  
150% Full scale

**Safe Sideload:**  
100% Full scale

**Rated Excitation:**  
10V DC (15V maximum)

**Total Error:**  
0.03% Full scale

**Insulation Resistance:**  
>2000 megohms

**Seal Type:**  
Hermetically sealed, IP66/68

**Cable Length:**  
25 ft/7.6 m

**Cable Diameter:**  
.200 polyurethane jacket

**Cable Color Code:**  
Red .....+ Excitation  
Black .....- Excitation  
Green .....+ Signal  
White .....- Signal

**Warranty:**  
Two-year limited warranty



## Dimensions

RATED CAPACITY	A1	A2	B	C	D	E	F	G	CONDUIT ADAPTER
<b>lb/inches</b>									
1000-5000	1.22	1.22	7.50	6.25	.62	.50	1.12	1.25	1/2-14 NPT
10,000-25,000	1.44	1.94	8.75	7.50	.62	.81	1.62	1.99	1/2-14 NPT
<b>kg/mm</b>									
453.6-2268.0	31.0	31.0	190.5	158.8	15.7	12.7	28.4	31.8	—
4535.9-11,339.8	36.6	49.3	222.3	190.5	15.7	20.6	41.1	50.5	—

## Order Information

LOAD RATING		PART #	PRICE
1000 lb	(453.6 kg)	67043	\$695.00
1500 lb	(680.4 kg)	67044	695.00
2000 lb	(907.2 kg)	67045	695.00
2500 lb	(1124.0 kg)	67046	695.00
5000 lb	(2268.0 kg)	67047	695.00
10,000 lb	(4535.9 kg)	67048	785.00
15,000 lb	(6803.9 kg)	67049	785.00
20,000 lb	(9071.8 kg)	67050	785.00
25,000 lb	(11,339.8 kg)	67051	785.00

## Interchangeable Products

MANUFACTURER	MODEL
Rice Lake Weighing Systems	RL75016 SS*
VPG Sensortronics	65016W
VPG Sensortronics	65016WH

\*Environmentally sealed, IP67

## Weigh Module Available

MANUFACTURER	MODEL
Rice Lake Weighing Systems	RL1600 Series

# RL75058

Double-Ended Beam, Alloy Steel, NTEP 1:10,000 Class IIIL Multiple Cell, IP67



Picture is a representation of actual product

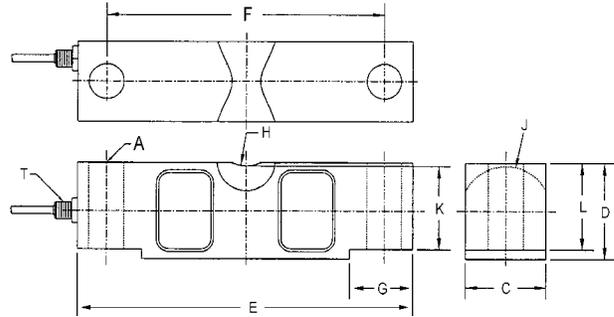

## Specifications

**Full Scale Output:**

3.0 mV/V

**Output Resistance:**

700 ohms, +/- 5

**Input Resistance:**

770 ohms, +/- 10

**Material/Finish:**

High-alloy steel, nickel plated

**Temperature:**Compensated range  
14°F to 104°F/-10°C to 40°C**Safe Overload:**

150% Full scale

**Safe Sideload:**

100% Full scale

**Rated Excitation:**

10V DC (15V maximum)

**Nonlinearity:**

0.03% Full scale

**Hysteresis:**

0.02% Full scale

**Insulation Resistance:**

5000 megohms

**Seal Type:**

Environmentally sealed, IP67

**Cable Length:**

35 ft/10.6 m

**Cable Diameter:**.200 polyurethane jacket 10 k-25 k  
.305 polyurethane jacket 40 k-125 k**Cable Coloring:**Red .....+ Excitation  
Black.....- Excitation  
Green.....+ Signal  
White.....- Signal**Warranty:**

Two-year limited warranty

**Approvals:**

## Dimensions

RATED CAPACITY	A	C	D	E	F	G	H	J	K	L	T
<b>lb/inches</b>											
10,000-25,000	.68	1.69	1.94	7.75	6.50	1.38	.75	.90	1.63	1.70	1/4-18 NPT
40,000	.81	1.94	2.44	10.25	8.50	1.93	1.00	1.12	2.00	2.10	1/4-18 NPT
50,000-75,000	1.06	2.44	2.94	10.25	8.50	1.93	1.00	1.37	2.54	2.65	1/2-14 NPT
100,000-125,000	1.62	2.90	3.86	15.25	12.75	3.13	1.50	1.80	3.30	3.43	1/2-14 NPT
<b>kg/mm</b>											
4536.1-11,339.8	17.3	42.9	49.3	196.9	165.1	35.1	19.1	22.9	41.4	43.2	1/4-18 NPT
18,143.7	20.6	49.3	62.0	260.4	215.9	49.0	25.4	28.5	50.8	53.3	1/4-18 NPT
22,679.6-34,019.4	26.9	62.0	74.7	260.4	215.9	49.0	25.4	34.8	64.5	67.3	1/2-14 NPT
45,359.4-56,699.1	41.2	737	980	387.4	323.9	79.5	38.1	45.7	83.8	87.1	1/2-14 NPT

## Order Information

LOAD RATING	PART #	PRICE
<b>NTEP 1:10,000</b>		
20,000 lb (9071.9 kg)	34314	\$635.00
25,000 lb (11,339.8 kg)	34315	635.00
40,000 lb (18,143.7 kg)	34316	760.00
50,000 lb (22,679.6 kg)	34317	835.00
60,000 lb (27,215.5 kg)	34318	835.00
75,000 lb (34,019.4 kg)	34319	835.00
100,000 lb (45,359.4 kg)	34320	1,575.00
125,000 lb (56,699.1 kg)	34321	1,575.00
<b>Non-NTEP</b>		
10,000 lb (4536.0 kg)	41890	615.00
<b>60' Cables</b>		
50,000 lb (22,679.6 kg)	53417	895.00
75,000 lb (34,019.4 kg)	39516	895.00
*75,000 lb (34,019.4 kg)	73839	995.00
125,000 lb (45,359.4 kg)	96944	1,625.00
<b>100' Cable</b>		
75,000 lb (34,019.4 kg)	74725	995.00

\*Stainless steel overbraided cable

## Interchangeable Products

MANUFACTURER	MODEL
VPG Sensortronics	65058
VPG Celtron	CLB

## Weigh Module Available

MANUFACTURER	MODEL
Rice Lake Weighing Systems	2100HE
Rice Lake Weighing Systems	MVS
Rice Lake Weighing Systems	TSA

## Replacement Load Cells for RL75058 Class III Rice Lake Coil Scale

LOAD RATING	PART #	PRICE
20,000	121439	\$635.00
25,000	121440	635.00
40,000	121441	760.00
50,000	121442	835.00
60,000	121443	835.00
75,000	121444	835.00

# RL75060S

Double-Ended Beam, Stainless Steel, Welded-Seal, IP67, NTEP 1:5000 III/1:10,000 Class III L Multiple Cell



Picture is a representation of actual product

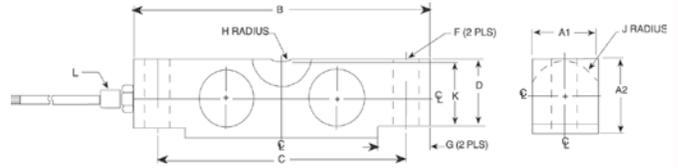

## Specifications

**Full Scale Output:**  
3.0mV/V

**Output Resistance:**  
699-707 ohms

**Input Resistance:**  
686-714 ohms

**Material/Finish:**  
Stainless steel

**Temperature:**  
Compensated range  
14°F to 104°F/-10°C to 40°C

**Safe Overload:**  
150% Full scale

**Safe Sideload:**  
100% Full scale

**Rated Excitation:**  
10V DC (15V maximum)

**Nonlinearity:**  
0.03% Full scale

**Hysteresis:**  
0.02% Full scale

**Insulation Resistance:**  
1000 megohms

**Seal Type:**  
Welded-seal, IP67

**Cable Length:**  
35 ft/10.6 m

**Cable Diameter:**  
.200 polyurethane jacket 20 k-25 k  
.305 polyurethane jacket 35 k-100 k

**Cable Coloring:**

- Red .....+ Excitation
- Black.....- Excitation
- Green .....+ Signal
- White .....- Signal

**Warranty:**  
Two-year limited warranty

**Approvals:**



## Dimensions

RATED CAPACITY	F	A1	A2	B	C	G	H	J	K	D	L
<b>lb/inches</b>											
20,000-25,000	.68	1.69	1.94	7.75	6.50	1.38	.75	.90	1.63	1.70	1/4-18 NPT
35,000-75,000	1.06	2.44	2.94	10.25	8.50	1.93	1.00	1.37	2.54	2.65	1/2-14 NPT
100,000	1.06	2.44	3.44	10.25	8.50	1.93	1.00	1.37	2.54	2.65	1/2-14 NPT
<b>kg/mm</b>											
9071.9	17.3	42.9	49.3	196.9	165.1	35.1	19.1	22.9	41.4	43.2	1/4-18 NPT
15,875.7-34,019.4	26.9	62.0	74.7	260.4	215.9	49.0	25.4	34.8	64.5	67.3	1/2-14 NPT
45,359.4	26.9	62.0	87.4	260.4	215.9	49.0	25.4	34.8	64.5	67.3	1/2-14 NPT

## Order Information

LOAD RATING		PART #	PRICE
20,000 lb	(9071.9 kg)	53481	\$875.00
25,000 lb	(11,339.8 kg)	50559	875.00
35,000 lb	(15,875.7 kg)	50560	1,095.00
50,000 lb	(22,679.6 kg)	50561	1,095.00
60,000 lb	(27,215.5 kg)	50562	1,095.00
75,000 lb	(34,019.4 kg)	50563	1,095.00
100,000 lb	(45,359.4 kg)	50564	2,295.00
<b>60 ft Cable</b>			
25,000 lb	(11,339.8 kg)	157931	925.00

## Interchangeable Products

MANUFACTURER	MODEL
VPG Scentroidronics	65058S

## Weigh Module Available

MANUFACTURER	MODEL
Rice Lake Weighing Systems	2100HE
Rice Lake Weighing Systems	MVS
Rice Lake Weighing Systems	TSA

# RL75223

Double-Ended Beam, Alloy Steel, Welded-Seal, IP67, NTEP 1:10,000 Class IIIL Multiple Cell



Picture is a representation of actual product

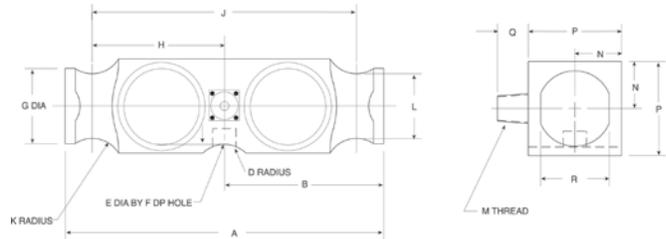

## Specifications

**Full Scale Output:**  
3.0 mV/V**Output Resistance:**  
699-707 ohms**Input Resistance:**  
686-714 ohms**Material/Finish:**  
High-alloy steel**Temperature:**  
Compensated range  
14°F to 104°F/-10°C to 40°C**Safe Overload:**  
150% Full scale**Safe Sideload:**  
100% Full scale**Rated Excitation:**  
10V DC (15V maximum)**Non-repeatability:**  
0.01% Full scale**Combined Error:**  
0.03% Full scale**Insulation Resistance:**  
5000 megohms**Deflection at Capacity:**  
50,000 lb=.018 in/.5 mm,  
65,000 lb=.022 in/.6 mm,  
100,000 lb=.034 in/.9 mm**Seal Type:**  
Welded-seal strain gauge\*, IP67**Cable Length:**  
40 ft/12.2 m**Cable Diameter:**  
.305 polyurethane jacket**Cable Color Code:**  
Red .....+ Excitation  
Black.....- Excitation  
Green .....+ Signal  
White .....Signal**Warranty:**  
Two-year limited warranty**Approvals:**

## Dimensions

RATED CAPACITY	A	B	D	E	F	G	H	J	K	L	M	N	P	Q	R
<b>lb/inches</b>															
50,000-65,000	10.25	5.12	1.00	.75	.78	2.40	4.25	8.50	1.00	2.06	1/2-14 NPT	1.50	3.00	1.03	2.20
100,000	10.25	5.12	1.00	—	—	2.40	4.25	8.50	1.00	2.06	1/2-14 NPT	1.50	3.00	1.03	2.20
<b>kg/mm</b>															
22,679.6-29,483.5	260.4	130.1	25.4	19.1	19.8	61.0	108.0	215.9	25.4	5.2	1/2-14 NPT	38.1	76.2	26.2	55.9
45,359.2	260.4	130.1	25.4	—	—	61.0	108.0	215.9	25.4	5.2	1/2-14 NPT	38.1	76.2	26.2	55.9

## Order Information

LOAD RATING	PART #	PRICE
**50,000 lb (22,679.6 kg)	107583	\$925.00
50,000 lb (22,679.6 kg)	21611	850.00
65,000 lb (29,483.5 kg)	21612	850.00
100,000 lb (45,359.2 kg)	21613	1,200.00

\*Conduit is recommended for maximum protection against the ingress of water and moisture through the cable entry

\*\*60' of cable

## Interchangeable Products

MANUFACTURER	MODEL
VPG Revere Transducers	5223
Artech®	80210
Thurman®	TSC 800
Vishay Sensortronics	65040A-XX-1127W
Unibrigde	DL9000

## Weigh Module Available

MANUFACTURER	MODEL
Rice Lake Weighing Systems	Translink



# RLDB50000S

Double-Ended Beam , Stainless Steel, NTEP 1:10000 IIIIL Multiple Cell, Welded-Seal, IP67



Picture is a representation of actual product

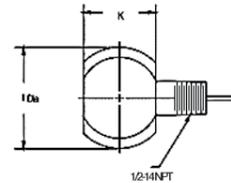
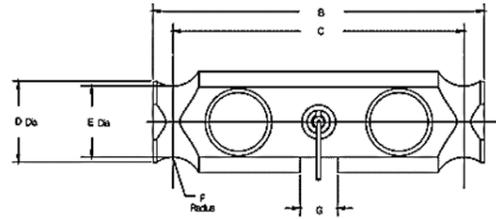

## Specifications

**Full Scale Output:**  
2±0.1% mV/V

**Output Resistance:**  
686-714 ohms

**Input Resistance:**  
699-707 ohms

**Material/Finish:**  
Stainless steel

**Temperature:**  
Compensated Range  
14°F-104°F/-10°C-40°C

**Safe Overload:**  
150% Full Scale

**Safe Sideload:**  
100% Full Scale

**Rated Excitation:**  
10V DC (15V DC maximum)

**Non-repeatability:**  
0.01% Full Scale

**Combined Error:**  
0.03% Full Scale

**Insulation Resistance:**  
5000 megohms

**Deflection at Capacity:**  
0.01 in/0.38 mm

**Seal Type:**  
Environmentally sealed, NEMA 6P/  
IP67

**Cable Length:**  
35 ft/10.6 m

**Cable Diameter:**  
.305 polyurethane jacket

### Cable Color Code:

Red .....+ Excitation  
Black.....- Excitation  
White.....- Signal  
Green.....+ Signal

### Warranty:

Two-year limited warranty

### Approvals:



## Dimensions

RATED CAPACITY	B	C	D	E	F	G	K	I
<b>lb/inches</b>								
50,000 lb	8.25	7.25	2.0	1.76	0.75	0.93	1.8	2.5
<b>kg/mm</b>								
22,679.6	209.55	184.15	50.8	44.7	19	23.6	45.72	63.50

## Order Information

LOAD RATING	PART #	PRICE
50,000 lb (22,679.6 kg)	91765	\$1,195.00

## Interchangeable Products

MANUFACTURER	MODEL
Cardinal®	DB50000S

# RL75040

Double-Ended Beam, Alloy Steel, NTEP 1:10,000 Class IIIIL Multiple Cell, IP67



Picture is a representation of actual product

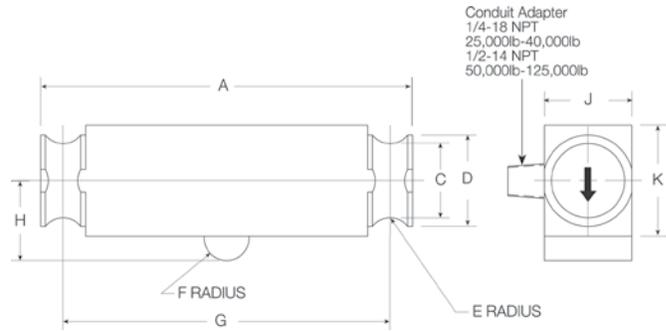

## Specifications

**Full Scale Output:**  
3.0 mV/V

**Output Resistance:**  
700 ohms, +/- 5

**Input Resistance:**  
770 ohms, +/- 10

**Material/Finish:**  
High-alloy steel, nickel plated

**Temperature:**  
Compensated range  
14°F to 104°F/-10°C to 40°C

**Safe Overload:**  
150% Full scale

**Safe Sideload:**  
100% Full scale

**Rated Excitation:**  
10V DC (15V maximum)

**Nonlinearity:**  
0.03% Full scale

**Hysteresis:**  
0.02% Full scale

**Insulation Resistance:**  
1000 megohms

**Seal Type:**  
Environmentally sealed, IP67

**Cable Length:**  
35 ft/10.6 m, 40 ft/12.2 m or  
50 ft/15.2 m

**Cable Diameter:**  
.200 polyurethane jacket 25 k  
.305 polyurethane jacket 40 k-75 k

### Cable Coloring:

Red .....+ Excitation  
Black.....- Excitation  
Green .....+ Signal  
White .....- Signal

### Warranty:

Two-year limited warranty

### Approvals:



## Dimensions

RATED CAPACITY	A	C	D	E	F	G	H	J	K
<b>lb/inches</b>									
25,000-40,000 50K SE and 60,000 SE	8.25	1.63	2.00	.50	.50	7.25	1.75	1.94	2.44
50,000-75,000	11.50	1.70	2.20	.75	1.00	10.00	2.00	1.94	2.94
100,000-125,000	14.50	2.44	3.20	1.00	1.50	12.50	2.75	2.90	3.86
<b>kg/mm</b>									
11,339.8-18,143.7 and 27,215.5 SE	209.6	41.4	50.8	12.7	12.7	184.2	44.5	49.3	62.0
22,679.6-34,019.4	292.1	43.2	55.9	19.1	25.4	254.0	50.8	49.3	74.7
45,359.2-56,699.1	368.3	62.0	81.3	25.4	38.1	317.5	69.9	73.7	98.0

## Order Information

LOAD RATING	PART #	PRICE
<b>35' Cable</b>		
25,000 lb (11,339.8 kg)	21614	\$635.00
40,000 lb (18,143.7 kg)	21615	760.00
50,000 lb (22,679.6 kg)	21616	835.00
60,000 lb (27,215.5 kg)	21617	835.00
75,000 lb (34,019.4 kg)	21618	835.00
100,000 lb (45,359.2 kg)	21619	1,575.00
125,000 lb (56,699.1 kg)	21620	1,575.00
<b>40' Cable Small Envelope</b>		
50,000 lb SE (22,679.6 kg)	87253	760.00
60,000 lb SE (27,215.5 kg)	53593	760.00
<b>50' Cable</b>		
50,000 lb (22,679.6 kg)	21621	865.00
60,000 lb (27,215.5 kg)	21622	865.00
75,000 lb (34,020 kg)	40951	865.00

SE refers to small envelope

## Interchangeable Products

MANUFACTURER	MODEL
VPG Sensortronics	65040A
Artech®	80310
Thurman®	TSC 840
VPG Celtron	DLB

## Weigh Module Available

MANUFACTURER	MODEL
Rice Lake Weighing Systems	Translink

# RLCSP1

Compression Canister , Stainless Steel Welded-Seal, IP67, NTEP 1:10,000 Class IIII Multiple Cell



Picture is a representation of actual product

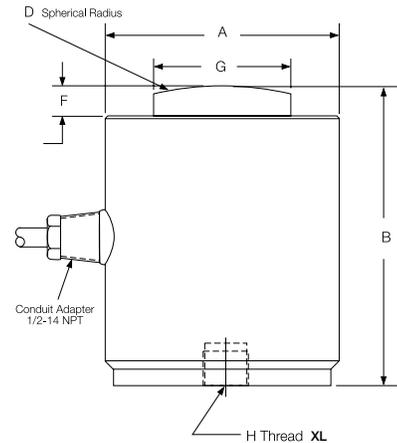

## Specifications

**Full Scale Output:**  
2.0 mV/V

**Output Resistance:**  
475.2-484.8 ohms

**Input Resistance:**  
445.5-454.5

**Material/Finish:**  
Stainless steel

**Temperature:**  
Compensated range  
14°F to 104°F/-10°C to 40°C

**Safe Overload:**  
150% Full scale

**Rated Excitation:**  
10V DC (15V maximum)

**Combined Error:**  
0.03% Full scale

**Non-repeatability:**  
0.01% Full scale

**Insulation Resistance:**  
1000 megohms

**Deflection at Capacity:**

25,000-50,000 lb=.003 in/.076 mm  
100,000-200,000 lb=.006 in/.152 mm

**Seal Type:**  
Welded-seal, IP67

**Cable Length:**  
35 ft/10.7 m

**Cable Diameter:**  
.305 polyurethane jacket

**Cable Color Code:**

Green .....+ Excitation  
Black.....- Excitation  
White .....+ Signal  
Red .....- Signal  
Orange..... Shield

**Warranty:**  
Two-year limited warranty

**Approvals:**



## Dimensions

RATED CAPACITY	A	B	D	F	G	H	L-DEPTH
<b>lb/inches</b>							
25,000	3.00	3.25	6.00	.40	1.25	1/2-20 UNF-2B	.31
100,000	4.00	5.00	6.00	.51	2.31	3/4-16 UNF-2B	.56
200,000	6.00	7.25	17.00	1.04	3.13	3/4-16 UNF-2B	.75
<b>kg/mm</b>							
11,339.8-22,679.6	76.2	82.6	152.4	10.2	31.8	1/2-20 UNF-2B	7.9
45,359.2	101.6	127.0	152.4	13.0	58.7	3/4-16 UNF-2B	14.2
90,718.5	152.4	184.2	431.8	26.4	79.5	3/4-16 UNF-2B	19.1

## Order Information

LOAD RATING		PART #	PRICE
25,000 lb	(11,339.8 kg)	32702	\$1,795.00
50,000 lb	(22,679.6 kg)	32701	1,795.00
100,000 lb	(45,359.2 kg)	32700	2,100.00
200,000 lb	(90,718.5 kg)	32699	2,995.00

## Interchangeable Products

MANUFACTURER	MODEL
VPG Sensortronics	65088-1000
VPG Revere Transducers	CSP
VPG Revere Transducers	692B
Howe Richardson®	244699-000X
Streeter Amet	3760XXX
<b>Weigh Module Available</b>	
Rice Lake Weighing Systems	MagnaMount®

# RLSCA-50K

Rocker Column, Stainless Steel Welded-Seal, IP67, NTEP 1:10,000 Class IIIL Multiple Cell



Picture is a representation of actual product

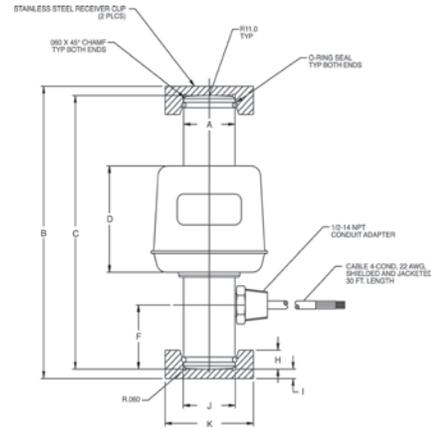

## Specifications

**Full Scale Output:**  
2 mv/V nominal

**Output Resistance:**  
1050 ohms +/- 10

**Input Resistance:**  
1100

**Material/Finish:**  
Stainless Steel

**Temperature:**  
Compensated range  
14°F to 104°F/-10°C to 40°C

**Safe Overload:**  
150% Full scale

**Rated Excitation:**  
10V DC (15V maximum)

**Combined Error:**  
.025% Full scale

**Non-repeatability:**  
.01% Full scale

**Insulation Resistance:**  
1000 megohms

**Seal Type:**  
Welded-seal, IP67

**Cable Length:**  
30 ft/9 m

**Cable Diameter:**  
.200 polyurethane jacket

### Cable Color Code:

Green .....+ Excitation  
Black.....- Excitation  
White .....- Signal  
Red .....+ Signal

### Warranty:

Two-year limited warranty

### Approvals:



## Dimensions

RATED CAPACITY	A	B	C	D	F	H	I	J	K
<b>lb/inches</b>									
50,000	1.46	7.75	7.25	2.82	1.70	.50	.25	1.48	2.50
<b>kg/mm</b>									
22,679.6	37.0	196.8	184.1	71.6	43.1	12.7	6.35	37.5	63.5

## Order Information

LOAD RATING	PART #	PRICE
*50,000lb (22,679.6 kg)	68918	\$995.00
Replacement load cup set upper and lower included	85433	95.00
Replacement O-rings	92988	1.00/each

\*Load cell supplied with load cups

## Interchangeable Products

MANUFACTURER	MODEL
Cardinal®	SCA-50K

# RL75114-50K

Rocker Column , Stainless Steel Welded-Seal, IP67, NTEP 1:10,000 Class III L



Picture is a representation of actual product

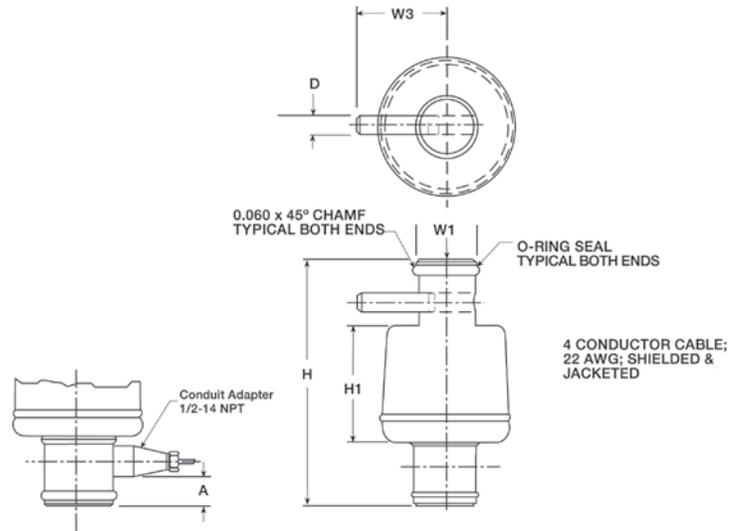

## Specifications

**Full Scale Output:**  
1.8 mV/v nominal

**Output Resistance:**  
1000 ohms +/- 10

**Input Resistance:**  
1000 ohms

**Material/Finish:**  
Stainless steel

**Temperature:**  
Compensated Range  
14°F-104°F/-10°C-40°C

**Safe Overload:**  
150%

**Rated Excitation:**  
10V DC

**Combined Error:**  
0.025% full scale

**Non-repeatability:**  
.01% full scale

**Insulation Resistance:**  
1000 megohms

**Seal Type:**  
Welded Seal IP67

**Cable Length:**  
30 ft/9 m

**Cable Diameter:**  
.200 overbraid cable

**Cable Color Code:**

- Green .....+ Excitation
- Black.....- Excitation
- White .....+ Signal
- Red .....- Signal

**Warranty:**  
Two-year limited warranty

**Approvals:**



## Dimensions

RATED CAPACITY	A	D	H	H1	W1	W3
<b>lb/inches</b>						
50,000 LE	.87	.38	7.56	2.82	1.46	2.18
<b>kg/mm</b>						
22,680.0	15.6	9.7	192.0	71.6	37.08	63.5

## Order Information

LOAD RATING	PART #	PRICE
50,000 lb (22,679.6 kg)	88074	\$1,195.00
Replacement o-ring	92988	1.00
Spring pin	116181	5.00

Not interchangeable with Sensortronics 65114 - different mV/v

## Interchangeable Products

MANUFACTURER	PART #	MODEL
Fairbanks	64166	LCFHR4020-2

# RL8C2P1SS

Compression Canister, Stainless Steel Hermetically Sealed, IP68, NTEP 1:10,000 Class III L Multiple Cell



Picture is a representation of actual product

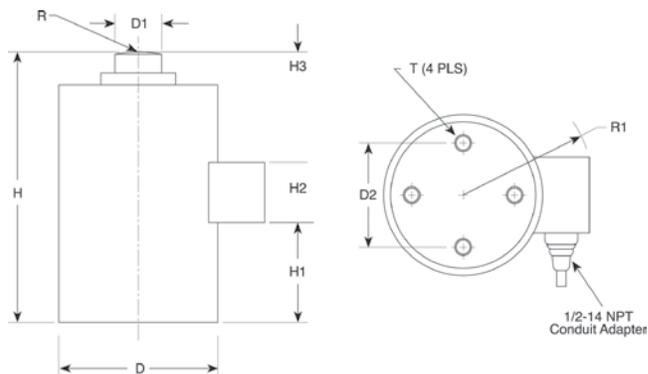

## Specifications

### Full Scale Output:

2.0mV/V

### Output Resistance:

350 ohms, +/- 3.5

### Output Resistance:

+/- 3.5

### Material/Finish:

Stainless steel

### Temperature:

Compensated range  
14°F to 104°F/-10°C to 40°C

### Safe Overload:

150% Full scale

### Rated Excitation:

10V DC (15V maximum)

### Non-repeatability:

0.01% Full scale

### Combined Error:

0.03% Full scale

### Insulation Resistance:

>1000 megohms

### Deflection at Capacity:

50,000 lb=.004 in/.102 mm,  
100,000 lb=.006 in/.152 mm,  
200,000 lb=.009 in/.228 mm

### Seal Type:

Hermetically sealed, IP68

### Cable Length:

35 ft/10.7 m

### Cable Color Code:

Green .....+ Excitation  
Black.....- Excitation  
White .....+ Signal  
Red .....- Signal  
Orange..... Shield

### Warranty:

Two-year limited warranty

### Approvals:



## Dimensions

RATED CAPACITY	D	D1	D2	H	H1	H2	H3	R	R1	T
<b>lb/inches</b>										
50,000	4.50	1.25	2.38	7.50	1.17	.75	.75	8.00	3.75	3/8-24 UNF-2B x .63 D
100,000	5.75	1.75	4.00	9.13	2.00	.87	1.05	12.00	4.05	1/2-20 UNF-2B x .75 D
200,000	7.50	2.50	5.50	11.63	2.93	.97	.97	12.00	5.11	5/8-18 UNF-2B x 25.4 D
<b>kg/mm</b>										
22,679.6	114.3	31.8	53.4	190.5	77.7	19.1	19.1	203.2	95.3	3/8-24 UNF-2B x .63 D
45,359.2	146.1	44.5	101.6	231.9	66.0	22.1	26.6	304.8	102.9	1/2-20 UNF-2B x .75 D
90,718.5	190.5	63.5	139.7	295.4	100.0	24.6	24.6	304.8	129.8	5/8-18 UNF-2B x 25.4 D

## Order Information

LOAD RATING		PART #	PRICE
50,000 lb	(22,679.6 kg)	34855	\$2,195.00
100,000 lb	(45,359.2 kg)	34856	2,195.00
200,000 lb	(90,718.5 kg)	34857	3,395.00

## Interchangeable Products

MANUFACTURER	MODEL
VPG Revere Transducers	792

# RL90000

Compression\* Disk, Alloy Steel, IP67



Picture is a representation of actual product  
Load cup sold separately on 5,000 and 10,000 lb models.

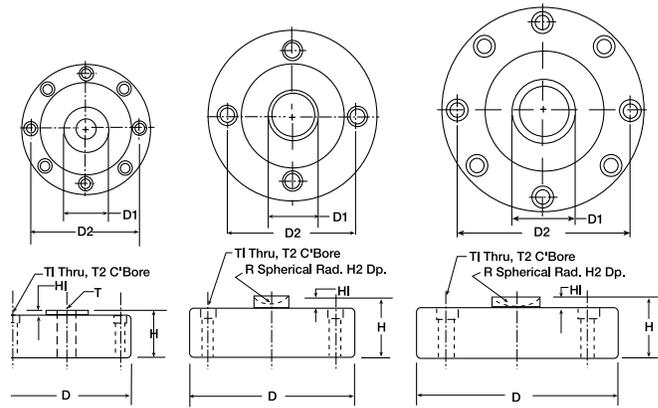

## Specifications

<p><b>Full Scale Output:</b> 4.0 mV/V</p> <p><b>Output Resistance:</b> 350 ohms +/- 3 (5K - 50K) 700 ohms +/- 5 (100K)</p> <p><b>Input Resistance:</b> 385 ohms +/- 5 (5K - 50K) 770 ohms +/- 70 (100K)</p> <p><b>Material/Finish:</b> High-alloy steel, nickel plated</p>	<p><b>Temperature:</b> Compensated range 14°F to 104°F/-10°C to 40°C</p> <p><b>Safe Overload:</b> 150% Full scale</p> <p><b>Safe Sideload:</b> 100% Full scale</p> <p><b>Rated Excitation:</b> 15V DC (15V maximum)</p> <p><b>Nonlinearity:</b> 0.05% Full scale</p>	<p><b>Hysteresis:</b> 0.02% Full scale</p> <p><b>Insulation Resistance:</b> 2000 megohms</p> <p><b>Seal Type:</b> Environmentally sealed</p> <p><b>Cable Length:</b> 50 ft/15.2 m</p> <p><b>Cable Diameter:</b> .200 polyurethane jacket 5 k-25 k .305 polyurethane jacket 50 k-100 k</p>	<p><b>Cable Color Code:</b> Red .....+ Excitation Black .....- Excitation Green .....+ Signal White .....- Signal</p> <p><b>Warranty:</b> Two-year limited warranty</p> <p><b>Approvals:</b> </p>
--	--	---	---

## Dimensions

RATED CAPACITY	T	R	D	D1	D2	H	H1	H2	T1	T2
<b>lb/inches</b>										
5000*-10,000*	5/8-18 UNF-3B	—	4.12	1.26	3.50	1.37	.12	—	.28	.406 x .283 DP
25,000-50,000	—	.875	4.75	1.53	4.00	2.12	.50	.30	.34	.508 x .38 DP
100,000	—	.875	5.50	1.98	4.60	2.25	.25	.30	.41	.626 x .4 DP
<b>kg/mm</b>										
2268.0*-4539.9*	5/8-18 UNF-3B	—	104.6	32.0	88.9	34.8	3.05	7.6	7.2	10.3 x 7.2 DP
11,339.8-22,679.7	—	22.2	120.7	38.9	101.6	53.8	12.7	7.6	8.7	12.9 x 9.7 DP
45,359.4	—	22.2	139.7	50.4	116.8	57.2	6.4	7.6	10.3	10.3 x 10.2 DP

## Order Information

LOAD RATING	PART #	PRICE
*5000 lb (2268.0 kg)	33061	\$650.00
*10,000 lb (4535.9 kg)	33062	650.00
25,000 lb (11,339.8 kg)	33063	795.00
50,000 lb (22,679.7 kg)	33064	795.00
100,000 lb (45,359.4 kg)	33065	935.00
*Load Cup	33616	35.00

\*5000 lb and 10,000 lb models can be used in compression and tension load applications.  
Load cup, part # 33616, is required for compression applications on 5000 lb and 10,000 lb capacity load cells.

## Interchangeable Products

MANUFACTURER	MODEL	PAGE #
VPG Celtron	LCD	210

# RLPC6

Single Point, Stainless Steel NTEP 1:5000 Class III Single Cell, Hermetically Sealed, IP69K



Picture is a representation of actual product

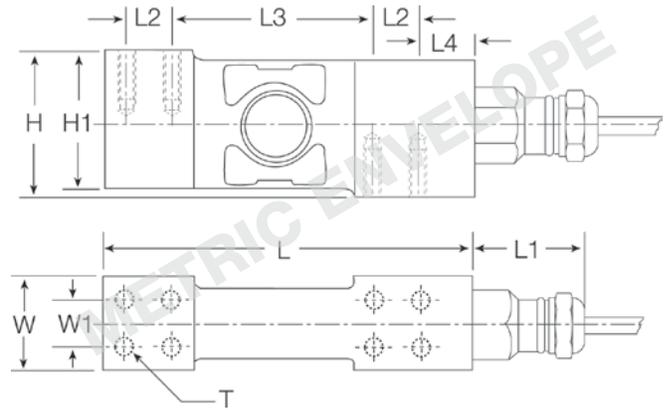

## Specifications

**Full Scale Output:**

2.0 mv/v

**Output Resistance:**

960 ohms, nominal +/- 50

**Input Resistance:**

1100 ohms +/- 50

**Material/Finish:**

Stainless steel

**Temperature:**

Compensated range  
14° F to 104° F / -10° C to 40° C

**Safe Overload:**

200% Full scale

**Safe Sideload:**

100% Full scale

**Rated Excitation:**

10V DC

**Total Error:**

0.02% Full scale

**Insulation Resistance:**

5000 megohms

**Seal Type:**

Hermetically sealed, IP69K

**Cable Length:**

10 ft/3.1 m

**Cable Diameter:**

.196 polyurethane jacket

**Cable Color Code:**

Green ..... + Excitation  
Black ..... - Excitation  
White ..... + Signal  
Red ..... - Signal  
Yellow ..... - Shield

**Max Deflection**

.006-.010

**Max Platform Size:**

24 in x 24 in

**Warranty:**

Two-year limited warranty

**Approvals:**

## Dimensions

RATED CAPACITY	H	H1	L	L1	L2	L3	L4	W	W1	T
<b>lb/inches</b>										
22-441.0	1.89	1.80	4.84	1.61	.60	2.66	.70	1.18	.60	8 x M6/15 DP
<b>kg/mm</b>										
10-200	48.0	45.5	123.0	41.0	15.2	67.6	17.8	30.1	15.2	8 x M6/15 DP

## Order Information

LOAD RATING		PART #	PRICE
10 kg	(22 lb)	87027	\$595.00
20 kg	(44.1 lb)	87028	595.00
50 kg	(110.2 lb)	87029	595.00
100 kg	(220.5 lb)	87030	595.00
200 kg	(441.0 lb)	87031	595.00

## Interchangeable Products

MANUFACTURER	MODEL
Flintec	PC6



# RLPWM15HE

Single Point, Stainless Steel IP69K, Hermetically Sealed, NTEP 1:5000 Class III Single Cell



Picture is a representation of actual product

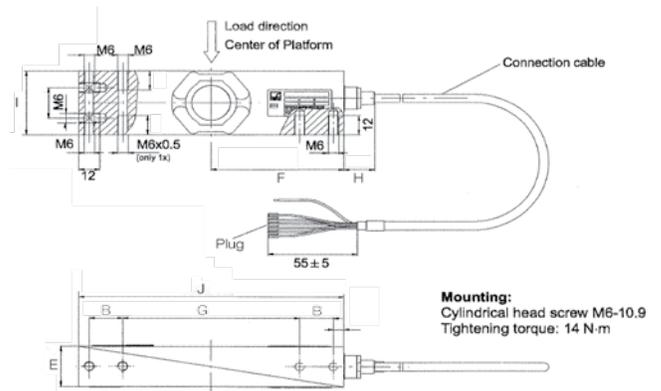

## Specifications

**Full Scale Output:**  
2.0mV/V

**Output Resistance:**  
350 ohms +/- 10

**Input Resistance:**  
380 ohms +/- 15

**Material/Finish:**  
Stainless Steel

**Temperature:**  
Compensated range  
14°F to 104°F/-10°C to 40°C

**Safe Overload:**  
150% Full scale

**Rated Excitation:**  
10V DC (15V maximum)

**Total Error:**  
0.02% Full scale

**Insulation Resistance:**  
1000 megohms

**Seal Type:**  
Hermetically sealed, IP69K

**Cable Length:**  
3.1 m/10 ft  
.86 m/2.83 ft

**Cable Diameter:**  
.212 PVC jacket

**Cable Color Code:**  
Blue ..... + Excitation  
Black..... - Excitation  
Green ..... + Sense  
Grey ..... - Sense  
White ..... + Signal  
Red ..... - Signal

**Warranty:**  
Two-year limited warranty

**Approvals:**



## Dimensions

RATED CAPACITY	B	E	F	G	H	I	J
<b>lb/inches</b>							
22/220.5	.75	.98	2.95	3.94	.69	1.57	5.91
<b>kg/mm</b>							
10-100	19	25	75	100	17.5	40	150

## Order Information: 10 ft cables

LOAD RATING	PART #	PRICE
10 kg (22.0 lb)	108685	\$595.00
20 kg (44.1 lb)	108686	595.00
50 kg (110.2 lb)	108687	595.00
100 kg (220.5 lb)	108688	595.00

## Interchangeable Products

MANUFACTURER	MODEL
HBM®	PW15AH

## Order Information: 2.83 ft cables

LOAD RATING	PART #	PRICE
10 kg (22.0 lb)	107174	\$595.00
20 kg (44.1 lb)	107175	595.00
50 kg (110.2 lb)	107176	595.00
100 kg (220.5 lb)	107177	595.00

# RLPWM15

Single Point, Stainless Steel, NTEP IP67, 1:5000 Class III Single Cell



Picture is a representation of actual product

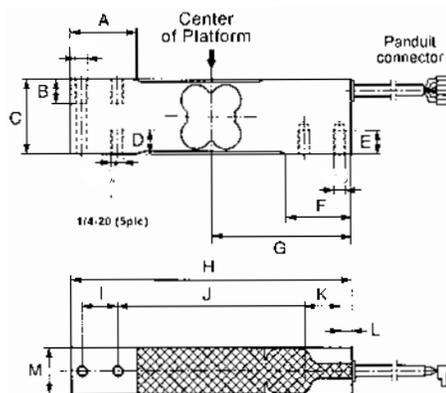

## Specifications

**Full Scale Output:**

2.0 mV/V

**Bridge Resistance:**

350 ohms, nominal

**Material/Finish:**

Stainless steel

**Temperature:**

Compensated range  
14°F to 104°F/-10°C to 40°C

**Safe Overload:**

150% Full scale

**Rated Excitation:**

10V DC (15V maximum)

**Total Error:**

0.02% Full scale

**Insulation Resistance:**

1000 megohms

**Seal Type:**

Environmentally sealed

**Cable Length:**

3.1 m/10 ft

**Cable Diameter:**

.190 PVC jacket

**Cable Color Code:**

Blue ..... + Excitation  
Black ..... - Excitation  
Green ..... + Sense  
Gray ..... - Sense  
White ..... + Signal  
Red ..... - Signal

**Warranty:**

Two-year limited warranty

**Approvals:**

## Dimensions

RATED CAPACITY	A	B	C	D	E	F	G	H	I	J	K	L	M
<b>lb/inches</b>													
22.1 - 330.7	1.37	.51	1.57	.51	.51	1.37	2.95	5.90	.74	3.93	.74	.24	.98
<b>kg/mm</b>													
10 - 150	35	13	40	13	13	35	75	150	19	100	19	6.2	25

## Order Information

LOAD RATING	PART #	PRICE
10 kg (22.1 lb)	119904	\$295.00
15 kg (33.1 lb)	119912	295.00
20 kg (44.1 lb)	119905	295.00
30 kg (66.2 lb)	119906	295.00
50 kg (110.3 lb)	119908	295.00
75 kg (165.3 lb)	119909	295.00
100 kg (220.5 lb)	119910	295.00
150 kg (330.7 lb)	119911	295.00

## Interchangeable Products

MANUFACTURER	MODEL
HBM®	PW15

# RLPCBC-60

Single Point, Stainless Steel NTEP 1:5000 Class III Single Cell, Hermetically Sealed IP69K



Picture is a representation of actual product

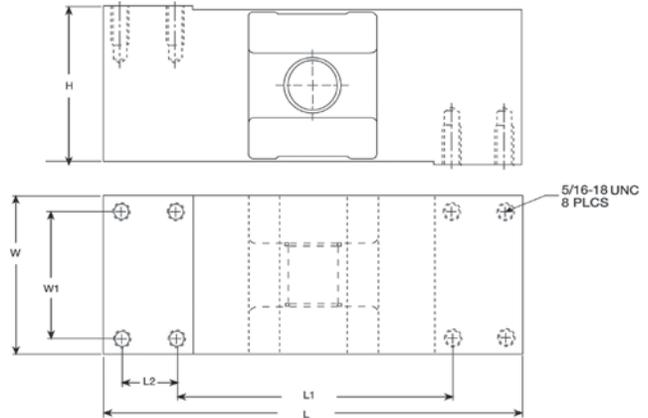

## Specifications

<b>Full Scale Output:</b> 2 mv/v <b>Output Resistance:</b> 960 ohms, nominal +/- 50 <b>Input Resistance:</b> 1100 ohms +/- 50 <b>1100 ohms +/- 50 Material/Finish:</b> Stainless steel <b>Temperature:</b> Compensated range: 14° F to 104° F/ -10° C to 40° C	<b>Safe Overload:</b> 200% Full scale <b>Safe Sideload:</b> 100% Full scale <b>Rated Excitation:</b> 10V DC <b>Total Error:</b> 0.020% Full scale <b>Insulation Resistance:</b> 5000 megohms <b>Seal Type:</b> Hermetically sealed, IP69K	<b>Cable Length:</b> 10 ft/3 m <b>Cable Diameter:</b> .196 polyurethane jacket <b>Cable Color Code:</b> Green ..... + Excitation Black ..... - Excitation White ..... + Signal Red ..... - Signal Yellow ..... Shield Blue ..... + Sense Brown ..... - Sense	<b>Max Platform Size:</b> 24 in x 24 in <b>Warranty:</b> Two-year limited warranty <b>Approvals:</b> 
--	--	---	--

## Dimensions

RATED CAPACITY	L	L1	L2	W	W1	H
<b>lb/inches</b>						
110.3-2205	7.50	4.21	1.38	2.90	1.97	2.90
<b>kg/mm</b>						
50-1000	190.5	107	35	73.7	50	73.7

## Order Information

LOAD RATING		PART #	PRICE
50 kg	(110.3 lb)	87022	\$850.00
100 kg	(220.5 lb)	87023	850.00
250 kg	(551.3 lb)	87024	850.00
500 kg	(1,102.5 lb)	87025	850.00
1000 kg	(2,205 lb)	87026	850.00

# RL1521A

Single Point, Aluminum NTEP 1:5000 Class III Single Cell



Picture is a representation of actual product

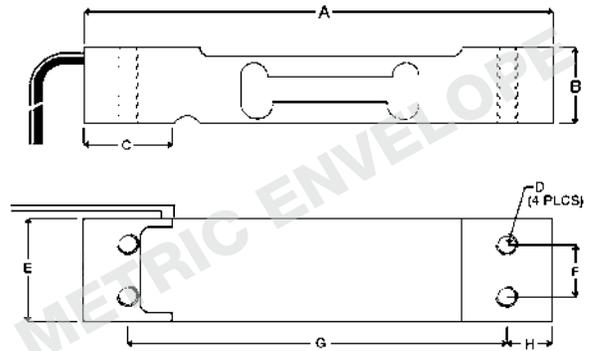

## Specifications

**Full Scale Output:**  
2.0mV/V

**Output Resistance:**  
350 ohm +/- 3

**Input Resistance:**  
410 ohms +/- 15

**Material/Finish:**  
Aluminum

**Temperature:**  
Compensated range  
14°F to 104°F/-10°C to 40°C

**Safe Overload:**  
150% Full scale

**Rated Excitation:**  
10V DC (15V maximum)

**Total Error:**  
0.03% Full scale

**Insulation Resistance:**  
2000 megohms

**Seal Type:**  
Environmentally sealed

**Cable Length:**  
1.50 ft/.5 m  
10 ft/3.1 m

**Cable Diameter:**  
.14 PVC jacket

**Cable Color Code:**  
Green ..... + Excitation  
Black..... - Excitation  
Red ..... + Signal  
White ..... - Signal

**Max Platform Size:**  
13.75 in x 13.75 in

**Warranty:**  
Two-year limited warranty

**Approvals:**



## Dimensions

RATED CAPACITY	A	B	C	D	E	F	G	H
<b>lb/inches</b>								
6.6-15.4	5.12	.87	.99	M6 x 1.0	1.00	.59	4.17	.47
22.0-66.2	5.12	.87	.99	M6 x 1.0	1.18	.59	4.17	.47
77.2	5.12	.87	.99	M6 x 1.0	1.57	.59	4.17	.47
<b>kg/mm</b>								
3-7	130.0	22.0	25.0	M6 x 1.0	25.4	15.0	106.0	12.0
10-30	130.0	22.0	25.0	M6 x 1.0	30.0	15.0	106.0	12.0
35	130.0	22.0	25.0	M6 x 1.0	40.0	15.0	106.0	12.0

## Order Information: 1.50' cables

LOAD RATING	PART #	PRICE
3 kg (6.6 lb)	50620	\$140.00
5 kg (11 lb)	50619	140.00
7 kg (15.4 lb)	50621	140.00
10 kg (22 lb)	50622	140.00
15 kg (33.1 lb)	50623	140.00
20 kg (44.1 lb)	50624	140.00
30 kg (66.1 lb)	50625	140.00
35 kg (110.2 lb)	50626	140.00

## Interchangeable Products

MANUFACTURER	MODEL
VPG Celtron	LPS except 3kg
VPG BLH	C2G1
Fairbanks®	4900 Series Checkweighers
NMB®	C2G1
VPG Tedeo-Huntleigh	1022
Artech®	61022

## Order Information: 10' cables

LOAD RATING	PART #	PRICE
3 kg (6.6 lb)	132261	\$140.00
5 kg (11 lb)	132262	140.00
7 kg (15.4 lb)	132263	140.00
10 kg (22 lb)	132264	140.00
15 kg (33.1 lb)	132265	140.00
20 kg (44.1 lb)	132266	140.00
30 kg (66.1 lb)	132267	140.00
35 kg (110.2 lb)	132268	140.00

# RL1010

Potted and Unpotted Single Point , Aluminum NTEP 1:5000 Class III Single Cell



Picture is a representation of actual product

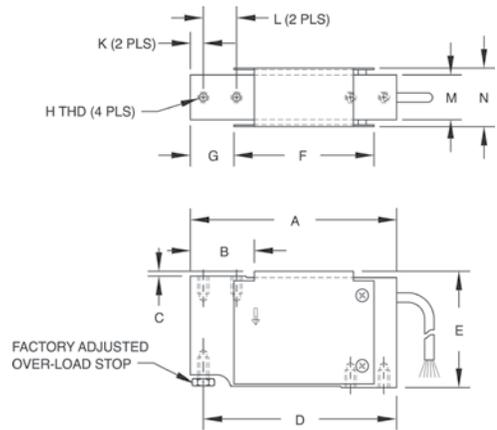

LOAD CELLS

## Specifications

**Full Scale Output:**  
2.0mV/V

**Output Resistance:**  
350 ohms, nominal +/- 3

**Input Resistance:**  
415 ohms +/- 15

**Material/Finish:**  
Anodized aluminum

**Temperature:**  
Compensated range  
14°F to 104°F/-10°C to 40°C

**Safe Overload:**  
150% at center of loading point, full scale

**Rated Excitation:**  
10V DC (15V maximum)

**Total Error:**  
.02% Full scale

**Insulation Resistance:**  
5000 megohms

**Deflection at Capacity:**  
3-90 kg ≤ .015 in/.4 mm

**Seal Type:**  
Potted and unpotted models available

**Cable Length:**  
Potted 3.1 m/10 ft, unpotted 0.9 m/3 in

**Cable Diameter:**  
.200/PVC jacket

**Cable Color Code:**  
Green .....+ Excitation  
Black.....- Excitation  
Blue .....+ Sense  
Brown .....- Sense  
Red .....+ Signal  
White .....- Signal

**Max Platform Size:**  
15.75 in x 15.75 in

**Warranty:**  
Two-year limited warranty

**Approvals:**  
FM APPROVED VPG CE

## Dimensions

RATED CAPACITY	A	B	C	D	E	F	G	H	K	L	M	N
<b>lb/inches</b>												
6.6-198.4	4.65	1.34	.12	4.35	2.60	3.15	.98	1/4-20 UNC x 0.50 DP	.30	.75	1.00	1.32
<b>kg/mm</b>												
3-90	118.1	34.0	3.0	110.5	66.0	80.0	25.0	1/4-20 UNC x 13 DP	7.5	19.1	25.4	33.5

## Order Information

LOAD RATING	PART #	PRICE
<b>Non-NTEP, Potted</b>		
7 kg (15.4 lb)	17529	\$195.00
10 kg (22 lb)	17530	195.00
15 kg (33.1 lb)	17531	195.00
20 kg (44.1 lb)	17532	195.00
30 kg (66.1 lb)	17533	195.00
50 kg (110.2 lb)	17534	195.00
90 kg (198.4 lb)	17535	195.00
<b>Non-NTEP, Unpotted</b>		
3 kg (6.6 lb)	17527	180.00
5 kg (11.0 lb)	17528	180.00
<b>NTEP 1:5000, Potted</b>		
10 kg (22.1 lb)	50819	195.00
15 kg (33.1 lb)	50820	195.00
20 kg (44.1 lb)	50821	195.00
30 kg (66.1 lb)	50822	195.00
50 kg (110.2 lb)	50823	195.00

## Interchangeable Products

MANUFACTURER	MODEL
VPG TedeA-Huntleigh	1010

www.ricelake.com | Phone: 800-472-6703

RICE LAKE

# RLSP4

Single Point, Aluminum NTEP 1:5000 Class III Single Cell



Picture is a representation of actual product

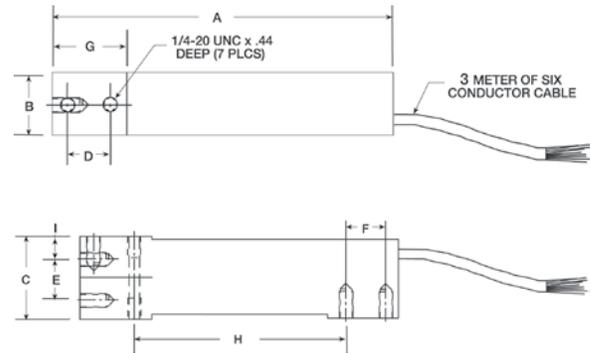

## Specifications

<b>Full Scale Output:</b> 2.0 mV/V	<b>Safe Overload:</b> 150% Full scale	<b>Cable Length:</b> 3.1 m/10 ft	<b>Max Platform Size:</b> 3 kg-10 kg (12 in x 12 in) 15 kg-30 kg (18 in x 18 in) 50 kg-100 kg (24 in x 24 in)
<b>Output Resistance:</b> 350 ohms +/- 3	<b>Rated Excitation:</b> 10V DC (15V maximum)	<b>Cable Diameter:</b> .19/PVC jacket	<b>Warranty:</b> Two-year limited warranty
<b>Input Resistance:</b> 350 min	<b>Combined Error:</b> 0.02% Full scale	<b>Cable Color Code:</b> Green ..... + Excitation Black ..... - Excitation Blue ..... + Sense Brown ..... - Sense Red ..... + Signal White ..... - Signal Yellow ..... Shield	<b>Approvals:</b>   
<b>Material/Finish:</b> Anodized Aluminum	<b>Insulation Resistance:</b> 5000 megohms		
<b>Temperature:</b> Compensated range 14°F to 104°F/-10°C to 40°C	<b>Deflection at Capacity:</b> 5-100 kg ≤ 0.4 mm/.015 in		
	<b>Seal Type:</b> Environmentally sealed		

## Dimensions

RATED CAPACITY	A	B	C	D	E	F	G	H	I
<b>lb/inches</b>									
6.6-220.5	5.92	1.0	1.57	.75	.75	.75	1.33	3.92	.45
<b>kg/mm</b>									
3 kg-100	150.3	25.4	39.9	19.1	19.1	19.1	33.8	99.6	11.4

## Order Information

LOAD RATING		PART #	PRICE
*3 kg	(6.6 lb)	91723	\$180.00
*5 kg	(11.0 lb)	91724	180.00
7 kg	(15.4 lb)	91725	180.00
10 kg	(22.1 lb)	91726	180.00
15 kg	(33.1 lb)	91727	180.00
20 kg	(44.1 lb)	91728	180.00
30 kg	(66.2 lb)	91729	180.00
50 kg	(110.3 lb)	91730	180.00
75 kg	(165.3 lb)	91731	180.00
100 kg	(220.5 lb)	91732	180.00

\*Non NTEP

## Interchangeable Products

MANUFACTURER	MODEL
HBM®	SP4
VPG Tedeá-Huntleigh	1042
Rice Lake Weighing Systems	RL1042

# RLPWM12

Single Point, Aluminum IP67, NTEP 1:5000 Class III Single Cell



Picture is a representation of actual product

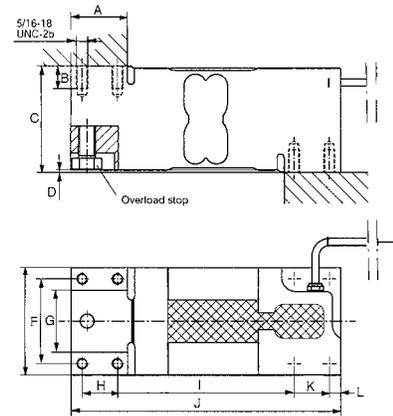

## Specifications

<b>Full Scale Output:</b> 2.0mV/V	<b>Safe Overload:</b> 150% Full scale	<b>Cable Length:</b> 3.1 m/10 ft	<b>Warranty:</b> Two-year limited warranty
<b>Output Resistance:</b> 330-450 ohms, nominal	<b>Rated Excitation:</b> 10V DC (15V maximum)	<b>Cable Diameter:</b> .190/PVC jacket	<b>Max Platform Size:</b> 30 in x 30 in
<b>Input Resistance:</b> 300-500	<b>Total Error:</b> 0.02% Full scale	<b>Cable Color Code:</b> Green ..... + Excitation Black ..... - Excitation Blue ..... + Sense Brown ..... - Sense Red ..... + Signal White ..... - Signal	<b>Approvals:</b>   
<b>Material/Finish:</b> Aluminum	<b>Insulation Resistance:</b> 1000 megohms		
<b>Temperature:</b> Compensated temperature range 14°F to 104°F/-10°C to 40°C	<b>Seal Type:</b> Environmentally sealed, IP67		

## Dimensions

RATED CAPACITY	A	B	C	D	E	F	H	I	J	K	L
<b>lb/inches</b>											
110.2-2205.0	1.57	.62	2.95	.05	2.99	2.36	.98	4.92	7.51	.98	.31
<b>kg/mm</b>											
50-1000	40	16	75	1.5	76	60	25	125	191	25	8

## Order Information

LOAD RATING		PART #	PRICE
50 kg	(110.2lb)	91674	\$300.00
75 kg	(165.4lb)	91675	300.00
100 kg	(220.5lb)	91676	300.00
150 kg	(330.7lb)	91677	300.00
200 kg	(440.9lb)	91678	300.00
250 kg	(551.2lb)	91679	300.00
300 kg	(661.4lb)	91680	300.00
500 kg	(1102.3lb)	91681	300.00
635 kg	(1400.1lb)	91682	300.00
1000 kg	(2205.0lb)	91683	300.00

## Interchangeable Products

MANUFACTURER	MODEL
*HBM*	PW12
VPg Tedeo-Huntleigh	1250
Rice Lake Weighing Systems	RL 1250

\*Color code is different

# RLPWM16

Single Point, Aluminum NTEP 1:5000 Class III Single Cell, IP67



Picture is a representation of actual product

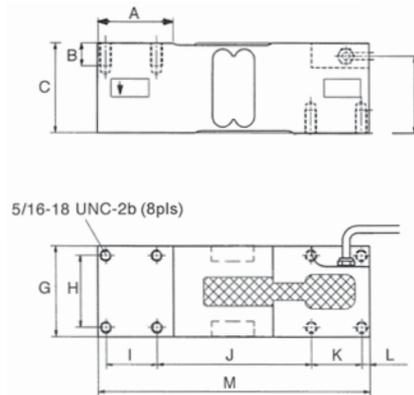

## Specifications

### Full Scale Output:

2.0 mV/V

### Output Resistance:

300-500

### Input Resistance:

300-500

### Material/Finish:

Aluminum

### Temperature:

Compensated temperature range  
14°F to 104°F/-10°C to 40°C

### Safe Overload:

150% Full scale

### Rated Excitation:

10V DC (15V maximum)

### Total Error:

0.02% Full scale

### Insulation Resistance:

1000 megohms

### Seal Type:

Environmentally sealed, IP67

### Cable Length:

3.1 m/10 ft

### Cable Diameter:

.190/PVC jacket

### Max Platform Size:

24 in x 24 in

### Cable Color Code:

Green .....+ Excitation  
Black .....- Excitation  
Blue .....+ Sense  
Brown .....- Sense  
Red .....+ Signal  
White .....- Signal

### Warranty:

Two-year limited warranty

### Approvals:



## Dimensions

RATED CAPACITY	A	B	C	F	G	H	I	J	K	L	M
<b>lb/inches</b>											
110.2-1455.5	2.04	.62	2.45	2.05	2.48	1.96	1.37	4.21	1.37	.21	7.40
<b>kg/mm</b>											
50-635	52	16	62.3	52.3	63	50	35	107	35	5.5	188

## Order Information

LOAD RATING	PART #	PRICE
50 kg (110.2 lb)	91684	\$275.00
75 kg (165.4 lb)	91686	275.00
100 kg (220.5 lb)	91687	275.00
150 kg (330.7 lb)	91688	275.00
200 kg (440.9 lb)	91689	275.00
250 kg (551.2 lb)	91690	275.00
300 kg (661.4 lb)	91691	275.00
500 kg (1102.3 lb)	91692	275.00
635 kg (1455.5 lb)	91693	275.00

## Interchangeable Products

MANUFACTURER	MODEL
*HBM®	PW16
VPG Tedeá-Huntleigh	1260
Rice Lake Weighing Systems	RL1260

\*Color code is different



# RL1042

Single Point, Aluminum NTEP 1:5000 Class III Single Cell

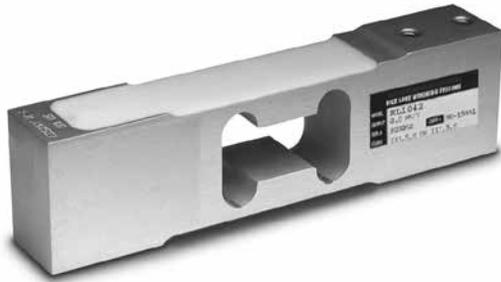

Picture is a representation of actual product

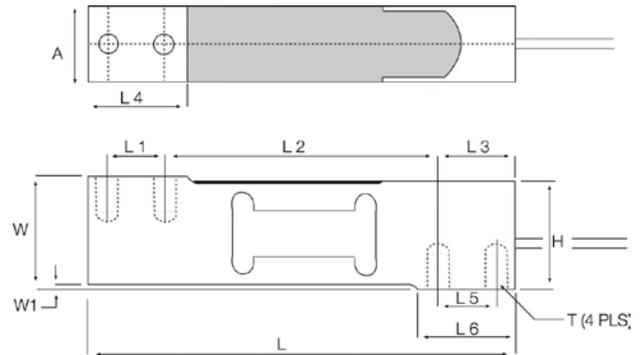

## Specifications

**Full Scale Output:**

2.0 mV/V

**Output Resistance:**

350 ohms +/- 3

**Input Resistance:**

415 ohms +/- 15

**Material/Finish:**

Aluminum

**Temperature:**

Compensated temperature range  
14°F to 104°F/-10°C to 40°C

**Safe Overload:**

150% Full scale  
Over center loading point

**Rated Excitation:**

10V DC (15V maximum)

**Total Error:**

0.02% Full scale

**Deflection at Capacity:**

1-100 kg ≤ .4 mm/.015"

**Insulation Resistance:**

2000 megohms

**Seal Type:**

Environmentally sealed

**Cable Length:**

3.1 m/10 ft

**Cable Diameter:**

.20/PVC jacket

**Cable Color Code:**

Green ..... + Excitation  
Black ..... - Excitation  
Blue ..... + Sense  
Brown ..... - Sense  
Red ..... + Signal  
White ..... - Signal

**Max Platform Size:**

15.75 in x 15.75 in

**Warranty:**

Two-year limited warranty

**Approvals:**



## Dimensions

RATED CAPACITY	A	H	L	L1	L2	L3	L4	L5	L6	W	W1	T
<b>lb/inches</b>												
2.2-66.1	.787	1.54	5.91	.75	3.937	.984	1.339	.75	1.339	1.575	.040	1/4-20 UNC-2B
110.2-220.5	.992	1.54	5.91	.75	3.937	.984	1.339	.75	1.339	1.575	.040	1/4-20 UNC-2B
<b>kg/mm</b>												
1-30	20.0	39	150.0	19.0	100.0	25.0	34.0	19.0	34.0	40.0	1.0	1/4-20 UNC-2B
50-100	25.2	39	150.0	19.0	100.0	25.0	34.0	19.0	34.0	40.0	1.0	1/4-20 UNC-2B

## Order Information

LOAD RATING		PART #	PRICE
1 kg	(2.2 lb)	40955	\$180.00
3 kg	(6.6 lb)	40956	180.00
5 kg	(11.0 lb)	40957	180.00
10 kg	(22.0 lb)	40958	180.00
15 kg	(33.1 lb)	40959	180.00
20 kg	(44.1 lb)	40960	180.00
30 kg	(66.1 lb)	40961	180.00
50 kg	(110.2 lb)	40962	180.00
75 kg	(165.4 lb)	40963	180.00
100 kg	(220.5 lb)	40964	180.00

## Interchangeable Products

MANUFACTURER	MODEL
VPG Tedeo-Huntleigh	1042
HBM®	SP4
Flintec	PC 42

# RL1040

Potted and Unpotted Single Point, Aluminum NTEP 1:5000 Class III Single Cell



Picture is a representation of actual product

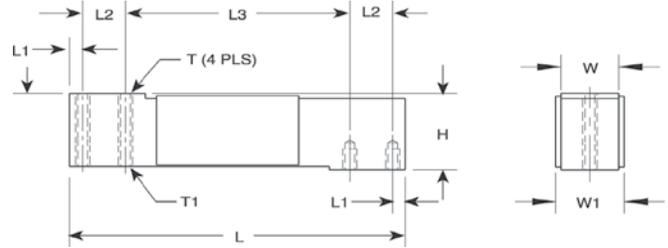

## Specifications

### Full Scale Output:

2.0 mV/V

### Output Resistance:

350 ohms +/- 3

### Input Resistance:

415 ohms +/- 5

### Material/Finish:

Anodized aluminum

### Temperature:

Compensated range  
14°F to 104°F/-10°C to 40°C

### Safe Overload:

200% at center loading point, full scale

### Rated Excitation:

10V DC (15V maximum)

### Total Error:

.02% Full scale

### Insulation Resistance:

2000 megohms

### Deflection at Capacity:

3-100 kg ≤ .4 mm/.015 in

### Seal Type:

Environmentally sealed, potted and unpotted models

### Cable Length:

3.1 m/10 ft

### Cable Diameter:

.20/PVC jacket

### Cable Color Code:

Green ..... + Excitation  
Black ..... - Excitation  
Blue ..... + Sense  
Brown ..... - Sense  
Red ..... + Signal  
White ..... - Signal

### Max Platform Size:

15.75 in x 15.75 in

### Warranty:

Two-year limited warranty

### Approvals:



## Dimensions

RATED CAPACITY	H	L	L1	L2	L3	T	T1	W	W1
<b>lb/inches</b>									
11-220.5	1.57	5.91	.23	.75	3.94	1/4-20 UNC x 0.39 DP	1/4-28 UNF x 0.39 DP	1.00	1.16
<b>kg/mm</b>									
5-100	40.0	150.0	5.95	19.05	100.0	1/4-20 UNC x 10 DP	1/4-28 UNF x 10 DP	25.4	29.4

## Order Information

LOAD RATING		PART #	PRICE
<b>NTEP 1:5000, Potted</b>			
7 kg	(15.4 lb)	32860	\$195.00
10 kg	(22.1 lb)	32861	195.00
15 kg	(33.1 lb)	32862	195.00
20 kg	(44.1 lb)	32863	195.00
30 kg	(66.1 lb)	32864	195.00
50 kg	(110.2 lb)	32865	195.00
100 kg	(220.5 lb)	32866	195.00
<b>NTEP 1:5000, Unpotted</b>			
5 kg	(11.0 lb)	32859	190.00

## Interchangeable Products

MANUFACTURER	MODEL
VPG Celtron	LOC
VPG Tedeá-Huntleigh	1040

# RL1140

Potted Single Point, Stainless Steel, IP67



Picture is a representation of actual product

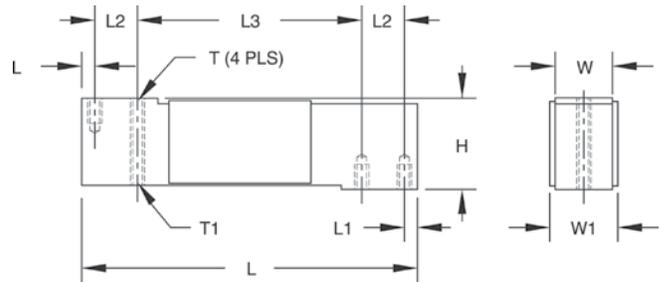

## Specifications

**Full Scale Output:**

2.0mV/V

**Output Resistance:**

350 ohms, nominal +/- 3

**Input Resistance:**

415 ohms +/- 15

**Material/Finish:**

Stainless steel

**Temperature:**

Compensated range  
14°F to 104°F/-10°C to 40°C

**Safe Overload:**

200% at center loading point,  
full scale

**Rated Excitation:**

10V DC (15V maximum)

**Total Error:**

.02% Full scale

**Insulation Resistance:**

2000 megohms

**Deflection at Capacity:**

15-150 kg ≤ .4 mm/.015 in

**Seal Type:**

Environmentally sealed, potted, IP67

**Cable Length:**

3.1 m/10ft

**Cable Diameter:**

.20/PVC jacket

**Cable Color Code:**

Green ..... + Excitation  
Black..... - Excitation  
Blue ..... + Sense  
Brown ..... - Sense  
Red ..... + Signal  
White ..... - Signal

**Max Platform Size:**

15.75 in x 15.75 in

**Warranty:**

Two-year limited warranty

**Approvals:**



## Dimensions

RATED CAPACITY	H	L	L1	L2	L3	T	T1	W	W1
<b>lb/inches</b>									
33.1-330.7	1.57	5.91	.23	.75	3.94	1/4-20 UNC x 0.39 DP	1/4-28 UNF x 0.39 DP	1.00	1.16
<b>kg/mm</b>									
15-150	40.0	150.0	5.95	19.05	100.0	1/4-20 UNC x 10 DP	1/4-28 UNF x 10 DP	25.4	29.4

## Order Information

LOAD RATING		PART #	PRICE
15 kg	(33.1 lb)	17544	\$320.00
30 kg	(66.1 lb)	17545	320.00
50 kg	(110.2 lb)	17546	320.00
75 kg	(165.4 lb)	17547	320.00
100 kg	(220.5 lb)	17548	320.00
150 kg	(330.7 lb)	36467	320.00

## Interchangeable Products

MANUFACTURER	MODEL
VPG TedeA-Huntleigh	1140

# RL1380

Single Point, Stainless Steel NTEP 1:3000 Class III Single Cell, IP67



Picture is a representation of actual product

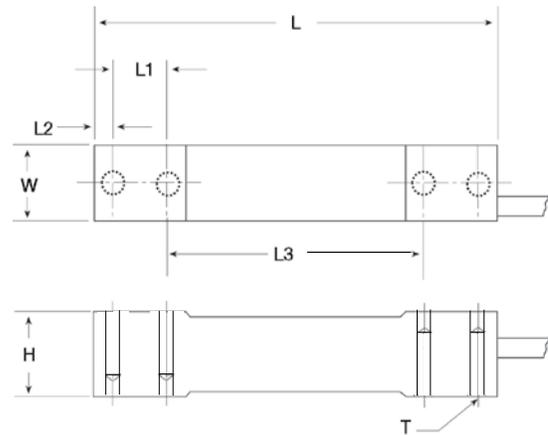

## Specifications

**Full Scale Output:**

2.0 mV/V

**Output Resistance:**

350 ohms +/- 3

**Input Resistance:**

350 ohms

**Material/Finish:**

Stainless steel

**Temperature:**Compensated range  
14°F to 104°F/-10°C to 40°C**Safe Overload:**

150% Full scale

**Rated Excitation:**

10V DC (15V maximum)

**Combined Error:**

0.03% Full scale

**Insulation Resistance:**

1000 megohms

**Seal Type:**

Environmentally sealed, IP67

**Cable Length:**

3.1 m/10ft

**Cable Diameter:**

.190 polyurethane jacket

**Cable Color Code:**Green ..... + Excitation  
Black ..... - Excitation  
White ..... + Signal  
Red ..... - Signal  
Yellow ..... Shield**Deflection:**

&lt;.4 mm FS

**Max Platform Size:**

15.75 in x 15.75 in

**Warranty:**

Two-year limited warranty

**Approvals:**

## Dimensions

RATED CAPACITY	W	L	L1	L2	L3	T	H
<b>lb/inches</b>							
15.4-33.1	.75	5.50	.75	.25	3.50	1/4-20 UNC	1.19
66.1-132.3	.94	5.50	.75	.25	3.50	1/4-20 UNC	1.19
<b>kg/mm</b>							
7-15	19.1	139.7	19.1	6.4	88.9	1/4-20 UNC	30.2
30-60	23.9	139.7	19.1	6.4	88.9	1/4-20 UNC	30.2

## Order Information

LOAD RATING	PART #	PRICE
7 kg (15.4 lb)	30783	\$295.00
10 kg (22.0 lb)	30782	295.00
15 kg (33.1 lb)	30781	295.00
30 kg (66.1 lb)	30780	295.00
60 kg (132.3 lb)	30779	295.00

## Interchangeable Products

MANUFACTURER	MODEL
HBM®	PWS

# RL1385

Single-Point , Stainless Steel NTEP 1:4500 Class III Single Cell, IP67



Picture is a representation of actual product

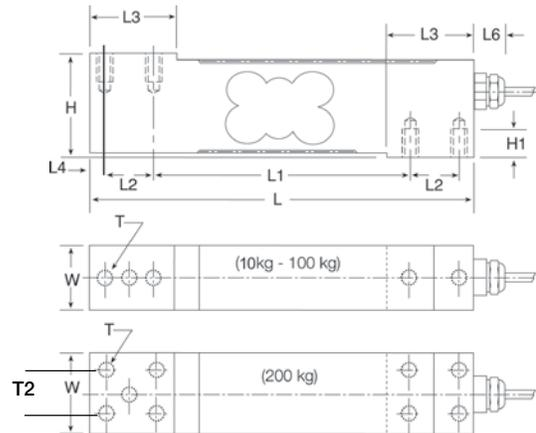

## Specifications

**Full Scale Output:**  
2.0 mV/V

**Output Resistance:**  
330 ohms +/- 25

**Input Resistance:**  
340 ohms +/- 20

**Material/Finish:**  
Stainless Steel

**Temperature:**  
Compensated range  
14°F to 104°F/-10°C to 40°C

**Safe Overload:**  
200% Full scale

**Rated Excitation:**  
5V DC (15V maximum)

**Combined Error:**  
0.02% Full scale

**Insulation Resistance:**  
5000 megohms

**Seal Type:**  
Environmentally sealed, IP67

**Cable Length:**  
3.1 m/10 ft

**Cable Diameter:**  
.196 polyurethane jacket

**Cable Color Code:**  
Green ..... + Excitation  
Black ..... - Excitation  
White ..... + Signal  
Red ..... - Signal  
Yellow ..... Shield

**Max Platform Size:**  
18 in x 18 in

**Warranty:**  
Two-year limited warranty

**Approvals:**



## Dimensions

RATED CAPACITY	H	H1	L	L1	L2	L3	L4	L6	W	T	T2
<b>lb/inches</b>											
13.2-220.5	1.57	.40	5.90	3.93	.75	1.26	.24	.79	1.00	1/4-20 x .75 DP	N/A
441.0	1.57	.40	5.90	3.93	.75	1.26	.24	.79	1.50	1/4-20 x .75 DP	1.00
<b>kg/mm</b>											
10-100	40.0	10.0	150.0	100.0	19.0	32.0	6.0	20.0	25.4	1/4-20 x 19.1 DP	N/A
200	40.0	10.0	150.0	100.0	19.0	32.0	6.0	20.0	38.1	1/4-20 x 19.1 DP	25.4

## Order Information

LOAD RATING	PART #	PRICE
10 kg (22.0 lb)	41405	\$295.00
15 kg (33.1 lb)	41233	295.00
30 kg (66.1 lb)	41234	295.00
50 kg (110.2 lb)	41235	295.00
75 kg (165.4 lb)	41236	295.00
*100 kg (220.5 lb)	41237	295.00
*200 kg (441.0 lb)	41406	440.00

\*Non NTEP

# RL1260

Single Point, Aluminum NTEP 1:5000 Class III Single Cell, IP67



Picture is a representation of actual product

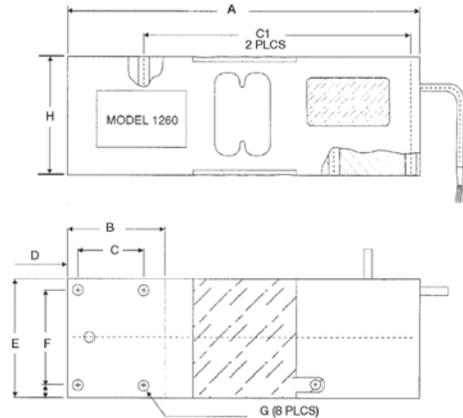

## Specifications

### Full Scale Output:

2.0mV/V

### Output Resistance:

350 ohms +/- 3

### Input Resistance:

415 ohms +/- 15

### Material/Finish:

Anodized aluminum

### Temperature:

Compensated range  
14°F to 104°F/-10°C to 40°C

### Safe Overload:

200% of full scale at center loading point

### Rated Excitation:

10V DC (15V maximum)

### Total Error:

0.02% Full scale

### Insulation Resistance:

5000 megohms

### Seal Type:

Environmentally sealed, IP67

### Cable Length:

3.1 m/10 ft

### Cable Diameter:

.220 polyurethane jacket

### Cable Color Code:

Green ..... + Excitation  
Black..... - Excitation  
Blue ..... + Sense  
Brown ..... - Sense  
Red ..... + Signal  
White ..... - Signal

### Max Platform Size:

24 in x 24 in

### Warranty:

Two-year limited warranty

### Approvals:



## Dimensions

RATED CAPACITY	A	B	C	C1	D	E	F	G	H
<b>lb/inches</b>									
110.2-1400.2	7.40	2.05	1.38	5.59	.22	2.49	1.97	5/16-18 UNC-2B	2.45
<b>kg/mm</b>									
50-635	188	52	35	142	5.5	63.5	50	5/16-18 UNC-2B	62.3

## Order Information

LOAD RATING		PART #	PRICE
50 kg	(110.2 lb)	41020	\$310.00
75 kg	(165.4 lb)	41021	310.00
100 kg	(220.5 lb)	41022	310.00
150 kg	(330.7 lb)	158469	310.00
200 kg	(440.9 lb)	41023	310.00
250 kg	(551.2 lb)	41024	310.00
300 kg	(661.4 lb)	41025	310.00
500 kg	(1102.3 lb)	41026	310.00
635 kg	(1400 lb)	41027	310.00

## Interchangeable Products

MANUFACTURER	MODEL
VPG Tedeo-Huntleigh	1260
HBM®	PW16
Rice Lake Weighing Systems	RLPWM16

# RL1250

Potted Single Point , Aluminum NTEP 1:5000 Class III Single Cell



Picture is a representation of actual product

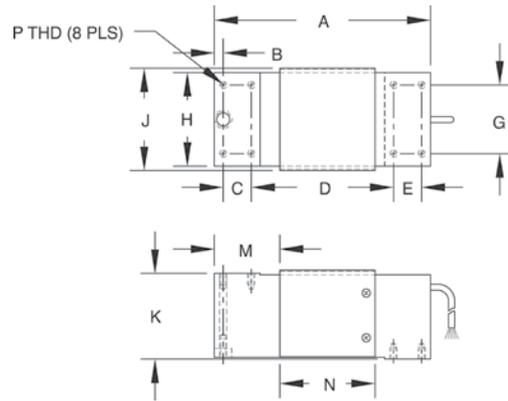

## Specifications

<b>Full Scale Output:</b> 2.0mV/V	<b>Safe Overload:</b> 150% of full scale at center loading point	<b>Seal Type:</b> Environmentally sealed, potted	<b>Max Platform Size:</b> 24 in x 24 in
<b>Output Resistance:</b> 350 ohms +/- 3	<b>Rated Excitation:</b> 10V AC/DC (15V maximum)	<b>Cable Length:</b> 3.1 m/10ft	<b>Warranty:</b> Two-year limited warranty
<b>Input Resistance:</b> 415 ohms +/-15	<b>Total Error:</b> .02% Full scale	<b>Cable Diameter:</b> .220 polyurethane jacket	<b>Approvals:</b> 
<b>Material/Finish:</b> Anodized aluminum	<b>Insulation Resistance:</b> 2000 megohms	<b>Cable Color Code:</b> Green .....+ Excitation Black.....- Excitation Blue .....+ Sense Brown .....- Sense Red .....+ Signal White .....- Signal	
<b>Temperature:</b> Compensated range 14°F to 104°F/-10°C to 40°C	<b>Deflection at Capacity:</b> 50-1000 kg ≤ .4 mm/.015 in		

## Dimensions

RATED CAPACITY	A	B	C	D	E	G	H	J	K	M	N	P
<b>lb/inches</b>												
110.2-1400.2	7.52	.43	.98	4.92	.98	2.36	2.95	3.23	2.95	2.26	3.35	5/16-18 UNC x 0.59 DP
<b>kg/mm</b>												
50-1000	191.0	11.0	25.0	125.0	25.0	60.0	75.0	82.0	75.0	57.5	85.0	5/16-18 UNC x 15 DP

## Order Information

LOAD RATING		PART #	PRICE
50 kg	(110.2 lb)	32849	\$315.00
75 kg	(165.4 lb)	32856	315.00
100 kg	(220.5 lb)	32855	315.00
150 kg	(330.7 lb)	32854	315.00
200 kg	(440.9 lb)	32853	315.00
250 kg	(551.2 lb)	32852	315.00
300 kg	(661.4 lb)	32851	315.00
500 kg	(1102.3 lb)	32850	315.00
635 kg	(1400 lb)	32857	315.00
1000 kg	(2205 lb)	32858	315.00

## Interchangeable Products

MANUFACTURER	MODEL
VPG Tedeo-Huntleigh	1250
VPG Celtron	LOC
Flintec	PCB*
HBM®	PW12
Rice Lake Weighing Systems	RLPWM12

\*Stainless steel, Hermetically sealed  
Shim plate-part# 22264

# RLFLS

Potted Single Point, Stainless Steel

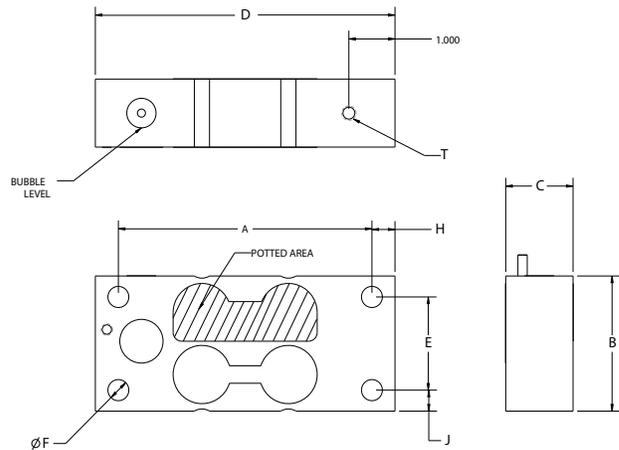

## Specifications

**Full Scale Output:**

1.0 mV/V +/- 10%

**Output Resistance:**

350 ohms +/- 3

**Input Resistance:**

385 ohms +/- 10

**Material/Finish:**

Stainless steel

**Temperature:**

Operating range:  
0° F-150° F/-18° C-65° C

**Safe Overload:**

150% full scale

**Rated Excitation:**

5-15 VDC

**Hysteresis:**

0.02% R.O.

**Linearity:**

0.02% R.O.

**Seal Type:**

Potted, IP67

**Insulation Resistance:**

5000 megohms

**Cable Length:**

10 ft/3.1 m

**Cable Color Code:**

Green ..... + Excitation  
Black ..... - Excitation  
Red ..... + Signal  
White ..... - Signal

**Warranty:**

Two-year limited warranty

## Dimensions

RATED CAPACITY	A	B	C	D	E	F	H	J	T
<b>lb/inches</b>									
50-75	5.50	2.90	.735	6.50	2.00	.453	.50	.45	5/16-18 UNC x .50
125-250	5.50	2.90	1.46	6.50	2.00	.453	.50	.45	5/16-18 UNC x .50
625	7.00	3.75	1.91	8.00	2.75	.520	.50	.50	—

## Order Information

LOAD RATING		PART #	PRICE
50 lb	22.7 kg	125612	\$595.00
75 lb	34.0 kg	125613	595.00
125 lb	56.9 kg	125614	595.00
250 lb	113.4 kg	125616	595.00
625 lb	283.4 kg	125617	750.00

## Interchangeable Products

MANUFACTURER	MODEL
Avery Weigh-Tronix®	FLS



# RLBLP

Planar Beam , Aluminum IP65

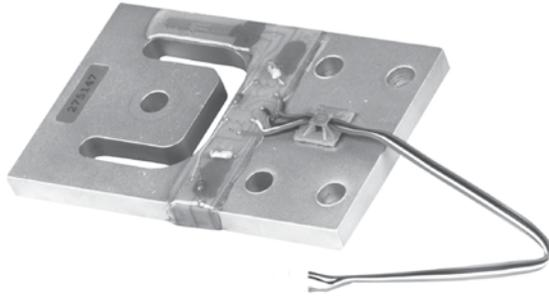

Picture is a representation of actual product

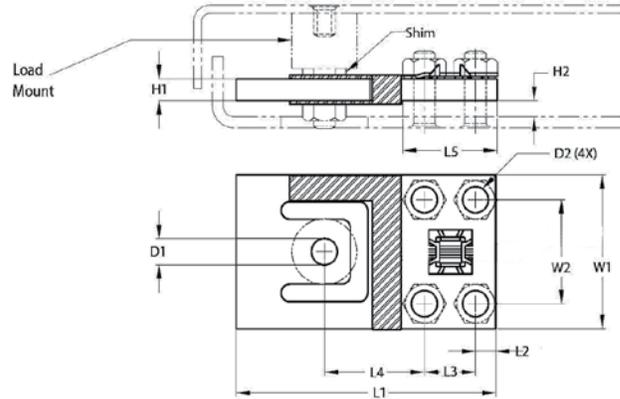

## Specifications

**Full Scale Output:**

1 mV/V

**Output Resistance:**

1000 ohms +/- 10

**Input Resistance:**

1180 ohms +/- 50

**Material/Finish:**

Aluminum

**Temperature:**

Operating range:  
0°F to 150°F/-18°C to 65°C

**Safe Overload:**

150% Full scale

**Rated Excitation:**

5-15V DC

**Combined Error:**

0.05% Full scale

**Seal Type:**

Environmentally sealed, IP65

**Insulation Resistance:**

5000 megohms

**Cable Length:**

1.0 m 3.75/7.5/15 kg  
1.5 m 37.5/75/150/375 kg

**Cable Color Code:**

Green ..... + Excitation  
Black ..... - Excitation  
White ..... + Signal  
Red ..... - Signal

**Warranty:**

Two-year limited warranty

## Dimensions

RATED CAPACITY KG/MM	L1	L2	L3	L4	L5	W1	W2	H1	H2 (MIN)	D1	D2
RLPB-15 kg-RS	70	4.9	14	28	23.7	39	27.8	4.1	4.5	7.6	5.1
RLPB-37.5 kg-RS	76.2	6	15	29.3	27	44.5	30	4.8	5	7.6	6.6
RLPB-75 kg-RS	84.4	6.4	15	34	27.7	54.8	30	6.4	5	7.6	6.6
RLPB-150 kg-RS	107.3	7.8	22.9	45.9	38.4	69.9	44.5	7.9	6	9.1	8.1

## Order Information

LOAD RATING		PART #	PRICE
15 kg	33.0 lb	100272	\$80.00
37.5 kg	82.6 lb	104645	85.00
75 kg	165.3 lb	100273	90.00
150 kg	330.7 lb	100274	95.00

## Interchangeable Products

MANUFACTURER	MODEL
Flintec	PB

# RL2010

Tension Link, Stainless Steel IP67



Picture is a representation of actual product

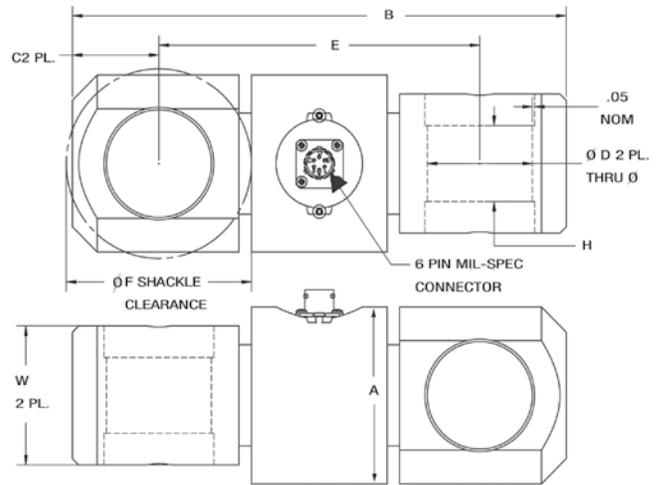

## Specifications

### Full Scale Output:

3.0 mV/V +/- 1%

### Bridge Resistance:

350 ohms, nominal

### Material/Finish:

Stainless steel

### Temperature:

Operating range  
10°F to 120°F/-12°C to 49°C

### Safe Overload:

150% Full scale

### Rated Excitation:

10V DC (15V maximum)

### Linearity:

0.05% Full scale

### Repeatability:

0.03% Full scale

### Insulation Resistance:

5000 megohms

### Seal Type:

Environmentally IP67

### Cable Length:

40 ft polyurethane jacket\*

### Cable Color Code:

Green ..... + Excitation  
Black ..... - Excitation  
White ..... + Signal  
Red ..... - Signal

### Warranty:

Two-year limited warranty

### Approvals:



## Dimensions

RATED CAPACITY	A	B	C	ØD	E	F	W	H
<b>lb/inches</b>								
5000-10,000	2.00	6.50	1.00	1.05	4.50	2.38	1.37	.075
25,000	2.75	8.00	1.38	1.55	5.25	2.88	2.00	1.00
50,000-75,000	3.25	14.00	2.50	2.31	9.00	5.00	3.00	1.75
100,000-150,000	4.00	16.00	2.88	2.88	10.25	6.25	4.00	2.00
200,000	6.00	18.00	3.25	3.38	11.50	6.50	4.75	2.38
250,000	6.50	20.00	3.75	3.88	12.50	7.50	5.00	2.75
300,000-500,000	7.50	24.00	4.50	4.31	15.00	9.50	5.40	3.00

## Order Information

LOAD RATING	PART #	PRICE
5000 lb (2268.0 kg)	117731	\$1,195.00
10,000 lb (4535.9 kg)	117732	1,195.00
25,000 lb (11,334.8 kg)	117733	1,395.00
50,000 lb (22,679.6 kg)	117735	2,495.00
75,000 lb (34,019.4 kg)	117736	2,495.00
100,000 lb (45,359.4 kg)	117737	2,695.00
150,000 lb (68,038.9 kg)	117738	2,695.00
200,000 lb (90,718.5 kg)	117739	4,895.00
250,000 lb (113,398.0 kg)	117740	5,295.00
300,000 lb (136,077.7 kg)	117741	7,500.00
500,000 lb (226,796.2 kg)	117742	7,500.00

40' Cable w/connector

## \*Shackles

LOAD RATING	PART #	PRICE
5K -10K	83450	\$195.00
25K	83451	605.00
50K	83452	895.00
75K	119279	1,595.00
100K	83453	2,925.00
150K - 200K	83454	3,695.00
250K	83455	4,459.00
300K	83456	10,840.00

\* Each pair

# Medical Scales

Table of Contents

<b>Personal Home Health</b> .....	<b>606</b>	<b>Wireless Wheelchair Scale</b> .....	<b>628</b>
<b>Certified Fitness Scale</b> .....	<b>608</b>	<b>Wheelchair Scale</b> .....	<b>629</b>
<b>Mechanical Physician Scale</b> .....	<b>609</b>	<b>Wheelchair Scale</b> .....	<b>634</b>
<b>Digital Physician Scale</b> .....	<b>613</b>	Single Ramp with Wheel Stop	
Eye Level		<b>Wheelchair Scale</b> .....	<b>635</b>
<b>Digital Physician Scale</b> .....	<b>614</b>	Dual Ramp	
Waist Level		<b>Wheelchair Scale</b> .....	<b>638</b>
<b>Mechanical Baby Scale</b> .....	<b>616</b>	Pit Frame Concrete Details	
<b>Digital Baby/Pediatric Scales</b> .....	<b>618</b>	<b>Wireless Bed Scale</b> .....	<b>639</b>
<b>Adult and Child Scale</b> .....	<b>619</b>	<b>Dietary Scale</b> .....	<b>640</b>
<b>Digital Baby/Pediatric Scale</b> .....	<b>620</b>	<b>Body Composition Analyzer</b> .....	<b>641</b>
<b>Neonatal Scale</b> .....	<b>622</b>		
<b>Bariatric Scales</b> .....	<b>623</b>		
<b>Mechanical Chair Scale</b> .....	<b>625</b>		
<b>Digital Chair Scales</b> .....	<b>627</b>		

**ESPAÑOL** | Visit [ricelake.com/spanish](http://ricelake.com/spanish)  
to see all RLWS materials  
available in Spanish

Product names, logos, brands, and other trademarks featured or referred to within this publication are the property of their respective trademark holders.

## Personal Home Health

### Standard Features

- Weigh in pounds, kilograms or stones
- Easy to read 1.5 in LCD display
- Durable platform with non-slip surface
- Auto holds weight value on display
- Lithium battery included
- Tap to turn on, automatic switch off

### Specifications

**Capacity:**

440 lb x 0.2 lb (200 kg x 0.1 kg)  
 1 st - 10 st x 0.5 lb; 10 st - 31 st x 1.0 lb  
 st = stone

**Platform Dimensions:**

13.7 in L x 12.9 in W x 1.625 in H

**Warranty:**

One-year limited warranty

### Part Number/Price

PART #	MODEL	CAPACITY	EST. SHIP WEIGHT	PRICE
112566	RL-440HH	440 lb x 0.2 lb (200 kg x 0.1 kg) 1st - 10 st x 0.5 lb; 10 st - 31st x 1.0 lb	4.0 lb	\$58.00



Model RL-440HH

# Personal Home Health

## Standard Features

- Easy to read 7.875 inch diameter dial
- Colorful markers for record purposes
- Durable steel base and platform
- Non-slip mat

## Specifications

### Capacity:

330 lb x 1 lb (RL-330HHL)

330 lb (150 kg) x 1 lb (0.5 kg) (RL-330HHD)

### Platform Dimensions:

16.93 in L x 11.22 in W x 2.5 in H

### Warranty:

One-year limited warranty

## Part Number/Price

PART #	MODEL	CAPACITY	EST. SHIP WEIGHT	PRICE
110592	RL-330HHL	330 lb x 1 lb	9.0 lb	\$58.00
113500	RL-330HHD	330 lb (150 kg) x 1 lb (0.5 kg)	9.0 lb	58.00



Model RL-330HHL



Model RL-330HHD

# Certified Fitness Scale

## Standard Features

- Capacity: 600 lb x 0.1 lb (270 kg x 0.05 kg)
- Platform dimensions: 14.5 x 14.5 x 3 in
- Large 1 inch LCD display
- AC adapter and internal rechargeable battery
- RS-232 output
- 6.5 ft cable between scale base and indicator
- Switch between lb and kg
- Light weight, 14 lb, for ease of transport

## Specifications

**Power:**

9 VDC, provided by AC adapter or internal rechargeable battery

**Battery Type:**

Sealed Lead Acid

**Battery Use:**

75 hours, automatic power off can be configured from 0-20 minutes

**Operating Temperature:**

32° F to 104° F (0° C to 40° C)

**Warranty:**

Two-year limited warranty

**Approvals:**

CE, NTEP CC 09-098, MC AM-5759

## Part Number/Price

PART #	MODEL #	CAPACITY	EST. SHIP WEIGHT	PRICE
119551	140-10-7N	600 lb (270 kg) x 0.1 lb (0.05 kg)	20 lb	\$495.00

## Options/Accessories

PART #	DESCRIPTION	PRICE
107445	Transport/carrying case	\$90.00



Model 140-10-7N

## APPROVALS



Measurement  
Canada  
Approved



Optional Transport/Carrying Case

# Mechanical Physician Scale

## Standard Features

- Dual read capacity and height rod
- Capacity: 440 lb x 4 oz (200 kg x 100 g)
- 10.75 in x 14.75 in Platform
- Sturdy enameled steel body
- Die cast beam
- Rugged scale understructure
- Removable slip-resistant plastic base cover
- Retractable aluminum height rod
- Easy operation with two sliding weights
- Rear wheels for portability ease

## Specifications

### Height Rod:

24-84 in (60-210 cm)

### Height Division:

0.125 in (0.1 cm)

### Warranty:

Two-year limited warranty

## Part Number/Price

PART #	MODEL	CAPACITY	EST SHIP WEIGHT	PRICE
102613	RL-MPS	440 lb (200 kg) x 4 oz (100 g)	43 lb	\$250.00

## DIMENSIONS

A	10.75 in (27.3 cm)	D	22.25 in (56.5 cm)
B	14.75 in (37.5 cm)	E	58.5 in (148.6 cm)
C	4.125 in (10.5 cm)		



Model RL-MPS

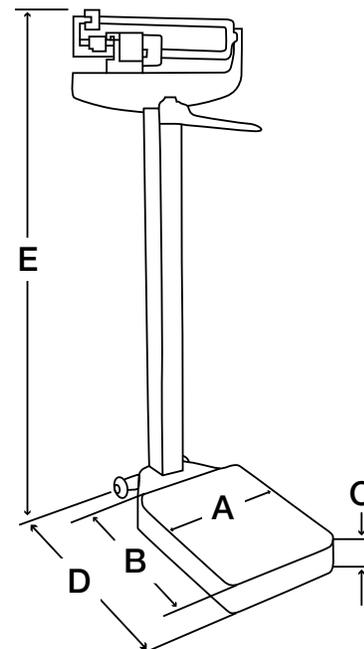

# Mechanical Physician Scale

## Standard Features

- Capacity: 450 lb x 4 oz
- 10.75 in x 14.75 in Platform
- Sturdy enameled steel body
- Die cast beam
- Rugged scale understructure
- Removable slip-resistant plastic base cover
- Retractable aluminum height rod, inches only
- Easy operation with two sliding weights
- Rear wheels for portability ease

## Specifications

**Height Rod:**  
24-84 in

**Height Division:**  
0.125 in

**Warranty:**  
Two-year limited warranty

## Part Number/Price

PART #	MODEL	CAPACITY	EST SHIP WEIGHT	PRICE
124223	RL-MPS-10	450 lb x 4 oz	43 lb	\$250.00

DIMENSIONS			
A	10.75 in (27.3 cm)	D	22.25 in (56.5 cm)
B	14.75 in (37.5 cm)	E	58.5 in (148.6 cm)
C	4.125 in (10.5 cm)		

**LB Only**



Model RL-MPS-10

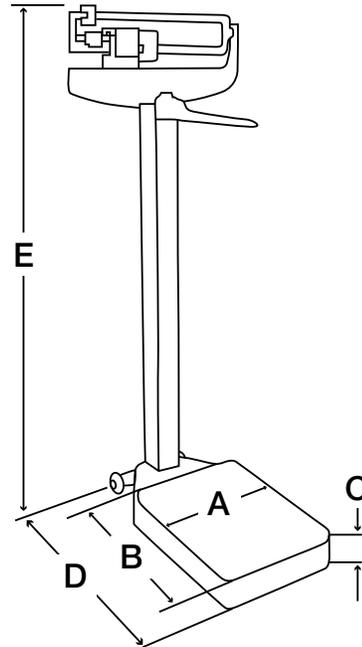



# Mechanical Physician Scale

## Standard Features

- Dual read capacity
- Capacity: 440 lb x 4 oz (200 kg x 100 g)
- 10.75 in x 14.75 inch Platform
- Sturdy enameled steel body
- Die cast beam
- Rugged scale understructure
- Removable slip-resistant plastic base cover
- Easy operation with two sliding weights

*LB and KG without height rod or wheels*

## Specifications

### Height Division:

0.125 in (0.1 cm)

### Warranty:

Two-year limited warranty

## Part Number/Price

PART #	MODEL	CAPACITY	EST SHIP WEIGHT	PRICE
124222	RL-MPS-20	440 lb (200 kg) x 4 oz (100 g)	41 lb	\$230.00

## DIMENSIONS

A	10.75 in (27.3 cm)	D	22.25 in (56.5 cm)
B	14.75 in (37.5 cm)	E	58.5 in (148.6 cm)
C	4.125 in (10.5 cm)		



Model RL-MPS-20

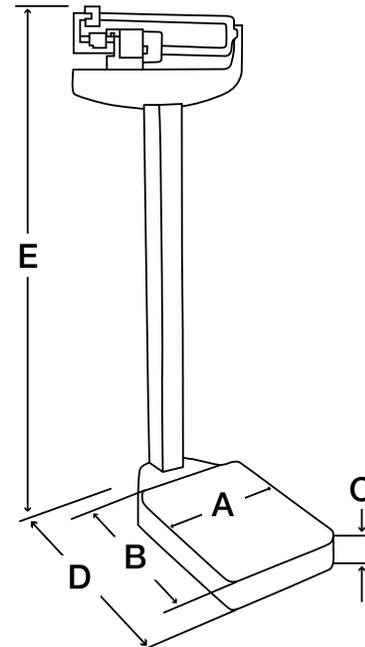

# Mechanical Physician Scale

## Standard Features

- Capacity: 180 kg x 100 g
- 10.75 in x 14.75 in Platform
- Sturdy enameled steel body
- Die cast beam
- Rugged scale understructure
- Slip-resistant plastic base cover
- Retractable aluminum height rod, centimeter only
- Easy operation with two sliding weights
- Rear wheels for portability ease

## Specifications

**Height Rod:**

60-212 cm

**Height Division:**

0.1 cm

**Warranty:**

Two-year limited warranty

## Part Number/Price

PART #	MODEL	CAPACITY	EST SHIP WEIGHT	PRICE
132703	RL-MPS-30	180 kg x 100 g	44 lb	\$265.00

### DIMENSIONS

A	10.75 in (27.3 cm)	D	22.25 in (56.5 cm)
B	14.75 in (37.5 cm)	E	58.5 in (148.6 cm)
C	4.125 in (10.5 cm)	F	31.5 in (80 cm)



Model RL-MPS-30

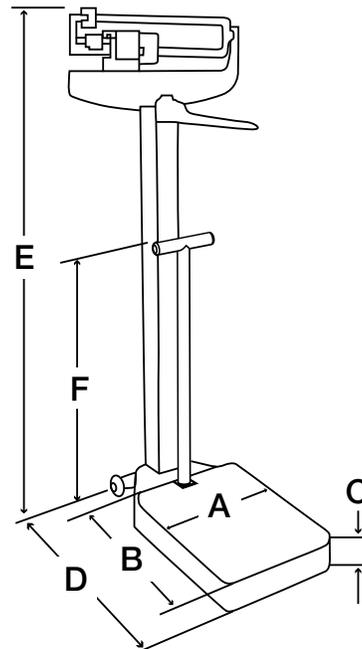

# Digital Physician Scale

Eye Level

## Standard Features

- Capacity: 550 x 0.2 lb (250 kg x 0.1 kg)
- Platform Dimensions: 14.5 in W x 14.5 in L x 3 in H
- Motiontrap™ (movement compensation technology)
- Large LCD display
- Six "AA" size Alkaline batteries included
- Low-battery indication/automatic power-off
- BMI (body mass index) function
- Hold function
- Unit of measure: lb only, kg only, Lb/Kg
- EMR capable
- Built-in height measuring rod measures from 27.5 in to 82 in x 1/8 in (70 cm to 208 cm x 1 mm)
- Integrated wheels for portability ease

## Specifications

### Power:

9 VDC, provided six "AA" alkaline batteries (included) or AC adapter (optional)

### Battery Type:

Six "AA" alkaline

### Battery Use:

25 hours, continuous use with batteries

### Approvals:

CE

### Warranty:

Two-year limited warranty

## Part Number/Price

PART #	MODEL	CAPACITY	EST. SHIP WEIGHT	PRICE
119113	150-10-5	550 x 0.2 lb (250 kg x 0.1 kg) with USB	26 lb	\$475.00
161818	150-10-5BT	550 lb x 0.2 lb (250 kg x 0.1 kg) with USB and Bluetooth	26 lb	550.00

## Options/Accessories

PART #	DESCRIPTION	PRICE
133077	9V AC adapter, 120V/230V auto switching †	\$15.00
102508	9V AC adapter, 230V ††	20.00

Motiontrap



Model 150-10-5

## APPROVALS



† NEMA 1-15 Plug

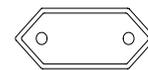

†† CEE 7/16 Euro Plug

# Digital Physician Scale

Waist Level

## Standard Features

- Capacity: 550 x 0.2 lb (250 kg x 0.1 kg)
- Platform Dimensions: 14.5 in W x 14.5 in L x 3 in H
- Motiontrap™ (movement compensation technology)
- Large LCD display
- Six "AA" size Alkaline batteries included
- Low-battery indication/automatic power-off
- BMI (body mass index) function
- Hold function
- Unit of measure: lb only, kg only, Lb/Kg
- EMR capable
- Integrated wheels for portability ease

## Specifications

**Power:**

9VDC, provided six "AA" alkaline batteries (included) or AC adapter (optional)

**Battery Type:**

Six "AA" alkaline

**Battery Use:**

25 hours, continuous use with batteries

**Approvals:**

CE

**Warranty:**

Two-year limited warranty

## Part Number/Price

PART #	MODEL	CAPACITY	EST. SHIP WEIGHT	PRICE
161786	150-10-6	550 lb x 0.2 lb (250 kg x 0.1 kg) with USB	26 lb	\$450.00
161819	150-10-6BT	550 lb x 0.2 lb (250 kg x 0.1 kg) with USB and Bluetooth	26 lb	525.00

## options/accessories

PART #	DESCRIPTION	PRICE
133077	9V AC adapter, 120V/230V auto switching †	\$15.00
102508	9V AC adapter, 230V ††	20.00



Model 150-10-6

## APPROVALS



† NEMA 1-15 Plug



†† CEE 7/16 Euro Plug

# Digital Physician Scale

## Standard Features

- Capacity 550 lb x 0.2 lb (250 kg x 0.1 kg)
- Platform dimensions 14.5 x 14.5 x 3 in
- Motiontrap™ (movement compensation technology)
- Large LCD display
- Six “AA” alkaline batteries
- Low battery indication/automatic power-off
- BMI (body mass index) function
- Hold function
- Unit of measure; lb only, kg only, Lb/Kg
- EMR capable

## Specifications

### Power:

9VDC provided by six alkaline “AA” batteries (standard) or 120V/230VAC adapter (optional)

### Battery Type:

Six “AA” alkaline

### Battery Use:

25 hours continuous use with batteries

### Approvals:

CE

### Warranty:

Two-year limited warranty

## Part Number/Price

PART #	MODEL	CAPACITY	EST. SHIP WEIGHT	PRICE
121304	150-10-7	550 x 0.2 lb (250 x 0.1 kg) with USB	25 lb	\$365.00
161820	150-10-7BT	550 lb x 0.2 lb (250 kg x 0.1 kg) with USB and Bluetooth	25 lb	440.00

## Options/Accessories

PART #	DESCRIPTION	PRICE
133077	9V AC adapter, 120V/230V auto switching †	\$15.00
102508	9V AC adapter, 230V ††	20.00
107445	Carrying case	90.00



Model 150-10-7



† NEMA 1-15 Plug

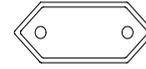

†† CEE 7/16 Euro Plug

# Mechanical Baby Scale

## Standard Features

- Dual-read capacity and measuring tape
- Built-in measuring tape 0-23 in (0-58 cm)
- Die cast beam
- Sturdy enameled steel body
- Easy-to-clean ABS plastic tray

## Specifications

**Tray Dimensions:**

24 W x 16 (D) x 3 in H  
 610 W x 406 (D) x 76 mm H

**Warranty:**

Two-year limited warranty

## Part Number/Price

PART #	MODEL	CAPACITY	EST. SHIP WEIGHT	PRICE
131470	RL-MIS	135 lb (62 kg) x 1 oz (20 g)	14 lb	\$265.00



Model RL-MIS

# Mechanical Baby Scale

## Standard Features

- Built-in measuring tape 0-58 cm
- Die cast beam
- Sturdy enameled steel body
- Easy-to-clean ABS plastic tray

## Specifications

### Tray Dimensions:

24 W x 16 (D) x 3 in H  
610 W x 406 (D) x 76 mm H

### Warranty:

Two-year limited warranty

## Part Number/Price

PART #	MODEL	CAPACITY	EST. SHIP WEIGHT	PRICE
131471	RL-MIS-20	70 kg x 20 g	14 lb	\$265.00

**KG Only**



Model RL-MIS-20

# Digital Baby/Pediatric Scales

## Standard Features

- Hold function
- Units of measure kg/lb/lb-oz
- Adjustable automatic shutoff
- Ergonomic handheld design
- Battery operated, two "AA" batteries included
- Carrying case and top s-hook included

## Part Number/Price

PART #	MODEL	CAPACITY	EST. SHIP WEIGHT	PRICE
130292	OS-10	10 x 0.01 kg/22 x 0.02 lb/ 22 lb x 1/4 oz	1.25 lb	\$75.00
130293	OS-25	25 x 0.02 kg/55 x 0.05 lb/ 55 lb x 1/2 oz	1.25 lb	75.00
130294	OS-45	45 x 0.05 kg/99 x 0.1 lb/ 99 lb x 1 oz	1.25 lb	75.00



Model OS-10/25/45

## Options/Accessories

PART #	DESCRIPTION	PRICE
141444	Suspended infant sling seat trousers	\$5.00



Optional suspended infant sling trousers



# Adult and Child Scale

## Standard Features

- Adult Child weighing mode allows the child to be accurately weighed while safely being held by an adult
- Tap to turn on, auto power off ensures long battery life
- Four “AA” batteries (included) and universal AC adapter (included)
- Lg/kg switch on bottom of scale
- Master ON/OFF power toggle switch on bottom of scale to keep scale from turning on accidentally during transportation
- Transport carry case (optional)

## Specifications

### Capacity

- 0-100 lb x 2 oz
- 100-400 lb x 4 oz
- 0-50 kg x 0.05 kg
- 50-200 kg x 0.1 kg

### Platform Dimensions:

- 12.68 x 12.68 x 1.97 in
- 322 x 322 x 50 mm

### Warranty:

One-year limited warranty

## Part Number/Price

PART #	MODEL	CAPACITY	EST. SHIP WEIGHT	PRICE
157108	D400	0-100 lb x 2 oz, 100-400 lb x 4 oz, 0-50 kg x 0.05 kg and 50-200 kg x 0.1 kg	9.0 lb	\$125.00

## Options/Accessories

PART #	DESCRIPTION	PRICE
107445	Transport/carrying case	\$90.00



Model D400



Optional Transport/Carrying Case

# Digital Baby/Pediatric Scale

## Standard Features

- Capacity: 44 lb x 0.5 oz (20 kg x 10 g)
- Convenient Lb/Kg toggle key
- Large, easy-to-read 1 inch Liquid Crystal Display (LCD)
- Built-in measuring tape: 0 - 22.5 in (0 - 57 cm)
- Recall key to view last weight measurement
- Four AA batteries (included) or AC adapter (included)
- Automatic shut-off ensures long battery life

## Specifications

**Capacity:**

44 lb x 0.5 oz  
20 kg x 0.01 kg

**Platform Dimensions:**

23.5 in L x 11 in W

**Power:**

Four AA batteries (included) or  
AC adapter (included)  
Adapter is UL and C-UL approved

**Warranty:**

Two-year limited warranty

## Part Number/Price

PART #	MODEL	CAPACITY	EST. SHIP WEIGHT	PRICE
107423	RL-DBS	44 lb x 0.5 oz (20 kg x 10 g) includes 120VAC adapter	10 lb	\$125.00
112571	RL-DBS	44 lb x 0.5 oz (20 kg x 10 g) includes 230VAC adapter	10 lb	125.00

## Options/Accessories

PART #	DESCRIPTION	PRICE
112570	Transport/carrying case (RL-DBS)	\$55.00
158463	Growth chart, boy, birth to 36 months, pack of 100 sheets	25.00
158464	Growth chart, girl, birth to 36 months, pack of 100 sheets	25.00
158465	Growth chart, boy, 2-20 years, pack of 100 sheets	25.00
158466	Growth chart, girl, 2-20 years, pack of 100 sheets	25.00



Model RL-DBS



Transport/Carrying Case

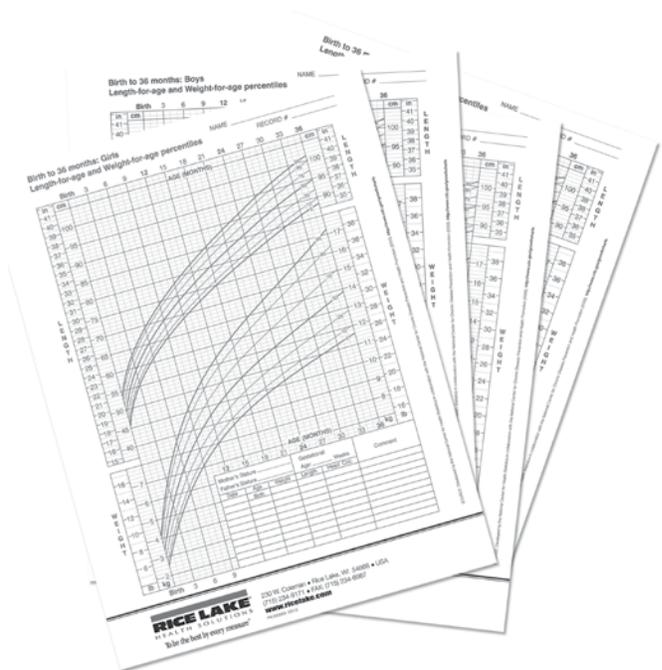

# Digital Baby/Pediatric Scale

## Standard Features

- Dual Range Capacity:  
0-22 lb x 0.2 oz (0-10 kg x 5 g)  
22-44 lb x 0.5 oz (10-20 kg x 10 g)
- Convenient Lb/Kg toggle key
- Large, easy-to-read 1 inch Liquid Crystal Display (LCD)
- Built-in measuring tape: 0 - 22.5 in (0 - 57 cm)
- Recall key to view last weight measurement
- Four "AA" batteries (included) or AC adapter (included)
- Automatic shut-off ensures long battery life



Model RL-DBS-2

## Specifications

### Capacity:

- 0-22 lb x 0.2 oz (0-10 kg x 5 g)
- 22-44 lb x 0.5 oz (10-20 kg x 10 g)

### Platform Dimensions:

23.5 in L x 11 in W

### Power:

- Four "AA" batteries (included) or AC adapter (included)
- Adapter is UL and C-UL approved

### Warranty:

Two-year limited warranty



Transport/Carrying Case

## Part Number/Price

PART #	MODEL	CAPACITY	EST. SHIP WEIGHT	PRICE
155922	RL-DBS-2	0-22 lb x 0.2 oz (0-10 kg x 5 g) 22-44 lb x 0.5 oz (10-20 kg x 10 g) includes 120VAC adapter	10 lb	\$150.00
155923	RL-DBS-02	0-22 lb x 0.2 oz (0-10 kg x 5 g) 22-44 lb x 0.5 oz (10-20 kg x 10 g) includes 230VAC adapter	10 lb	150.00

## Options/Accessories

PART #	DESCRIPTION	PRICE
112570	Transport/carrying case (RL-DBS-2)	\$55.00
158463	Growth chart, boy, birth to 36 months, pack of 100 sheets	25.00
158464	Growth chart, girl, birth to 36 months, pack of 100 sheets	25.00
158465	Growth chart, boy, 2-20 years, pack of 100 sheets	25.00
158466	Growth chart, girl, 2-20 years, pack of 100 sheets	25.00

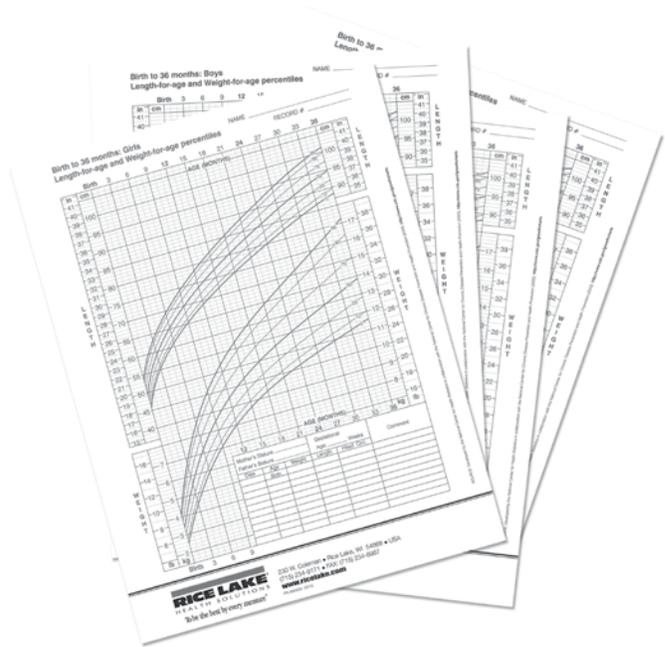

# Neonatal Scale

## Standard Features

- Capacity: 0-10 lb (0-5 kg) x 0.05 oz (1 g); 10-33 lb (5-15 kg) x 0.1 oz (2 g)
- Tray dimensions: 11 in x 23.5 in x 3 in
- Two-sided removeable tray with built-in measuring tape (up to 23.5 in x 1/8 in or 60 cm x 1/4 cm)
- Motiontrap™ (movement compensation technology)
- 0.75 inch LCD display
- Reweigh function
- Low battery indication
- Auto shut-off ensures long battery life

## Specifications

**Power:**  
12VDC, provided by six "AA" alkaline batteries (included) or AC adapter (optional).

**Battery Type:**  
Six "AA" alkaline

**Operating Temperature:**  
50°F to 95°F (10°C to 35°C)

**Warranty:**  
Two-year limited warranty

**Approvals:**  
CE

## Part Number/Price

PART #	MODEL	CAPACITY	EST. SHIP WEIGHT	PRICE
161784	650-10-1	0-10 lb (0-5 kg) x 0.05 oz (1 g) 10-33 lb (5-15 kg) x 0.1 oz (2 g)	25 lb	\$795.00

## Options/Accessories

PART #	DESCRIPTION	PRICE
165138	AC adapter	\$45.00
110995	Stainless Steel cart (inside rail dimensions 23 in L x 16.5 in W)	616.00



Model 650-10-1

## APPROVALS



Optional Stainless Steel Cart

# Bariatric Scales

## Standard Features

- Platform dimensions: 20 in x 25 in x 3 in
- Handrails for extra support and safety
- Integrated wheels for portability ease
- Motiontrap™ (movement compensation technology)
- Large 1 inch LCD display
- Low battery indicator/automatic power-off
- BMI (body mass index) function
- Hold function
- Unit of measure: lb only, kg only, Lb/Kg
- EMR capable, USB
- Updatable firmware
- Capacity: 1000 lb x 0.2 lb (450 kg x 0.1 kg)

## Specifications

### Power:

9VDC, provided by six "AA" alkaline batteries (included) or AC adapter (optional)

### Battery Type:

Six "AA" alkaline

### Battery Use:

25 hours continuous with batteries

### Operating Temperature:

50°F to 104°F (14°C to 40°C)

### Warranty:

Two-year limited warranty

### Approvals:

CE

## Part Number/Price

PART #	MODEL	CAPACITY	EST. SHIP WEIGHT	PRICE
<b>Bariatric/Handrail</b>				
133119	250-10-2	1000 lb (450 kg) x 0.2 lb (0.1 kg)	65 lb	\$1,040.00

## Options/Accessories

PART #	DESCRIPTION	PRICE
133077	9V AC adapter 120V/230V auto switching †	\$15.00
102508	9V AC adator, 230V ††	20.00

## DIMENSIONS

A	20 in	D	25 in
B	25 in	E	34 in
C	3 in	F	44.5 in

Motiontrap



Bariatric Model 250-10-2

## APPROVALS

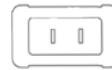

† NEMA 1-15 Plug

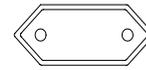

†† CEE 7/16 Euro Plug

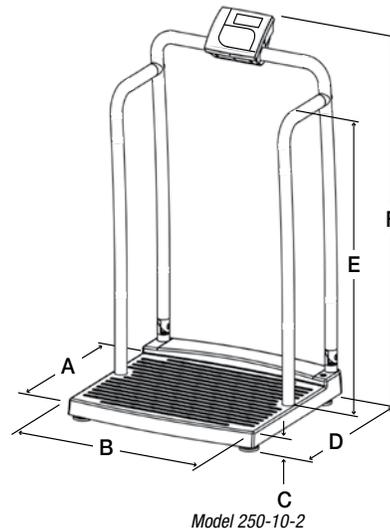

Model 250-10-2

# Bariatric Scales

## Standard Features

- Platform dimensions: 20 in x 25 in x 3 in
- Handrails for extra support and safety
- Integrated wheels for portability ease
- Motiontrap™ (movement compensation technology)
- Large 1 inch LCD display
- Low battery indicator/automatic power-off
- BMI (body mass index) function
- Hold function
- Unit of measure: lb only, kg only, Lb/Kg
- EMR capable, USB
- Updatable firmware
- Capacity: 1000 lb x 0.2 lb (450 kg x 0.1 kg)

### Bariatric/Handrail with Chair Seat (Model 250-10-4)

- Folding seat

## Specifications

### Power:

9VDC, provided by six "AA" alkaline batteries (included) or AC adapter (optional)

### Battery Type:

Six "AA" alkaline

### Battery Use:

25 hours continuous with batteries

### Operating Temperature:

50°F to 104°F (14°C to 40°C)

### Warranty:

Two-year limited warranty

### Approvals:

CE

## Part Number/Price

PART #	MODEL	CAPACITY	EST. SHIP WEIGHT	PRICE
<b>Bariatric/Handrail with Chair Seat</b>				
133120	250-10-4	1000 lb (450 kg) x 0.2 lb (0.1 kg)	75 lb	1,640.00

## Options/Accessories

PART #	DESCRIPTION	PRICE
133077	9V AC adapter 120V/230V auto switching †	\$15.00
102508	9V AC adator, 230V ††	20.00



Bariatric/Handrail with Chair Seat Model 250-10-4

## APPROVALS

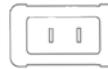

† NEMA 1-15 Plug

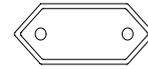

†† CEE 7/16 Euro Plug

Model 250-10-2

# Mechanical Chair Scale

## Standard Features

- Capacity: 440 lb x 0.25 lb (200 kg x 100 g)
- Swing-up arms for easy access and exit
- Fold up footrest
- Sturdy enameled, steel frame
- Dual read die cast beam
- ABS plastic seat 17 in (D) x 18.3 in W
- Swing-up armrests
- Heavy duty wheels - two back wheels lock, two front wheels swivel

## Specifications

### Capacity:

450 lb x 0.25 lb (200 kg x 0.1 kg)

### Seat Size:

17 in (D) x 18.3 in W

### Warranty:

Two-year limited warranty

## Part Number/Price

PART #	MODEL	CAPACITY	EST. SHIP WEIGHT	PRICE
111326	RL-MCS	440 lb (200 kg) x 4 oz (100 g)	85 lb	\$495.00



Model RL-MCS



# Mechanical Chair Scale

## Standard Features

- Capacity: 440 lb x 0.25lb
- Swing-up arms for easy access and exit
- Fold up footrest
- Sturdy enameled, steel frame
- Dual read die cast beam
- ABS plastic seat 17 in (D) x 18.3 in W
- Heavy duty wheels - two back wheels lock, two front wheels swivel

## Specifications

**Capacity:**

450 lb x 0.25 lb

**Seat Size:**

17 in (D) x 18.3 in W

**Warranty:**

Two-year limited warranty

## Part Number/Price

PART #	MODEL	CAPACITY	EST. SHIP WEIGHT	PRICE
124221	RL-MCS-10	450 lb x 4 oz	85 lb	\$495.00

**LB Only**



Model RL-MCS-10

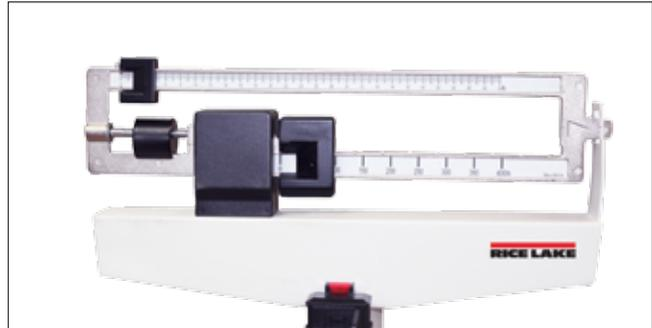



# Digital Chair Scales

## Standard Features

- Swing-up arm rests and fold up footrest to ease patient access
- Motiontrap™ (movement compensation technology)
- Four locking casters
- Large LCD display
- Unit of measure: lb only, kg only, Lb/Kg
- Six "AA" alkaline batteries included
- Low-battery indication/automatic power-off
- EMR capable USB
- BMI (body mass index) function

## Specifications

### Power:

9VDC provided by six "AA" alkaline batteries (standard) or 120V/230VAC adapter (optional)

### Battery Type:

Six "AA" alkaline

### Battery Use:

25 hours continuous use with batteries

### Warranty:

Two-year limited warranty

### Approvals:

CE

## Part Number/Price

PART #	MODEL	CAPACITY	WEIGHT	PRICE
<b>Chair Scale</b>				
119114	550-10-1	660 lb (300 kg) x 0.2 lb (0.1 kg)	44 lb	\$895.00

## Options/Accessories

PART #	DESCRIPTION	PRICE
133077	9V AC adapter, 120V/230V auto switching †	\$15.00
102508	9V AC adapter, 230V ††	20.00

Motiontrap



Model 550-10-1

## APPROVALS



† NEMA 1-15 Plug

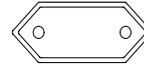

†† CEE 7/16 Euro Plug

# Wireless Wheelchair Scale

## Standard Features

- Lightweight design to ease portability
- Simple user Interface
- Four scale pads
- One handheld controller
- Four wheel stops
- Four roll-up ramps
- One lanyard
- One rubber glove for controller



Model D300

## Specifications

**Capacity:**

800 lb x 0.1 lb (363 kg x 0.05 kg)  
 1,200 lb x 0.5 lb (544 kg x 0.02 kg)

**Power:**

Eight EL-123 batteries per scale system 2 per pad (included)  
 Three "AAA" lithium batteries (included) for handheld controller

**Construction:**

Powder coated molded plastic and cast aluminum

**Operating Temperature:**

50°F to 90°F (14°C to 35°C)

**Warranty:**

Two-year limited warranty

**Approvals:**

CE

## APPROVALS



Hard-shell Rolling Case



Wheelchair Positioned on Pads

## Part Number/Price

PART #	MODEL	CAPACITY	EST. SHIP WEIGHT	PRICE
157141	D300-8	800 lb x 0.5 lb (363 kg x 0.2 kg)	15 lb	\$2,495.00
158214	D300-12	1,200 lb x 0.5 lb (544 kg x 0.2 kg)	15 lb	3,295.00

## Options/Accessories

PART #	DESCRIPTION	PRICE
158226	Hard-shell, rolling case with wheels	\$250.00



# Wheelchair Scale

## Standard Features

- Capacity: 1000 lb x 0.2 lb (450 kg x 0.1 kg)
- Platform dimensions: 29.5 in x 32 in
- Single ramp for on-off access
- Two wheels for portability ease
- Motiontrap™ (movement compensation technology)
- Large 1 inch LCD display
- Ability to manually enter the tare weight of a wheelchair
- BMI (body mass index) function
- Hold function
- Unit of measure: lb only, kg only, Lb/Kg
- EMR capable, USB

## Specifications

### Power:

9VDC, provided by 6 "AA" alkaline batteries (included) or AC adapter (optional)

### Battery Type:

6 "AA" alkaline

### Battery Use:

25 hours continuous use with batteries

### Operating Temperature:

50°F to 104°F (14°C to 40°C)

### Warranty:

Two-year limited warranty

### Approvals:

CE

## Part Number/Price

PART #	MODEL	CAPACITY	WEIGHT	PRICE
<b>Single Ramp Wheelchair Scale</b>				
141445	350-10-2	1000 lb (450 kg) x 0.2 lb (0.1 kg)	72 lb	\$1,040.00

## Options/Accessories

PART #	DESCRIPTION	PRICE
133077	9V AC adapter, 120V/230V auto switching †	\$15.00
102508	9V AC adapter, 230V ††	20.00

## DIMENSIONS

Wheelchair Scale			
A	29.5 in	D	9.25 in
B	32 in	E	37.5 in
C	2.375 in	F	39.75 in



Wheelchair Scale Model 350-10-2



Wheelchair scale in folded position

## APPROVALS



† NEMA 1-15 Plug

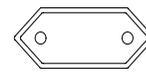

†† CEE 7/16 Euro Plug

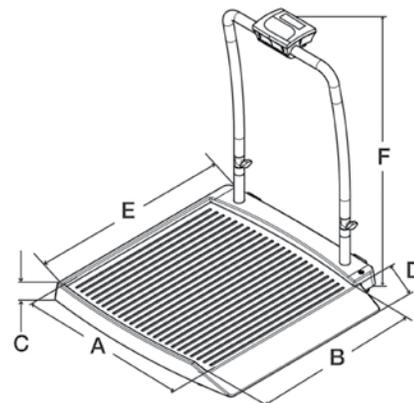

# Wheelchair Scale

## Standard Features

- Capacity: 1000 lb x 0.2 lb (450 kg x 0.1 kg)
- Platform dimensions: 29.5 in x 32 in
- Single ramp for on-off access
- Two wheels for portability ease
- Motiontrap™ (movement compensation technology)
- Large 1 inch LCD display
- Ability to manually enter the tare weight of a wheelchair
- BMI (body mass index) function
- Hold function
- Unit of measure: lb only, kg only, Lb/Kg
- EMR capable, USB
- 6.5 ft cable between scale base and indicator

## Specifications

**Power:**

9VDC, provided by six "AA" alkaline batteries (included) or AC adapter (optional)

**Battery Type:**

Six "AA" alkaline

**Battery Use:**

25 hours continuous use with batteries

**Operating Temperature:**

50°F to 104°F (14°C to 40°C)

**Warranty:**

Two-year limited warranty

**Approvals:**

CE

## Part Number/Price

PART #	MODEL	CAPACITY	WEIGHT	PRICE
<b>Single Ramp Wheelchair Platform Scale</b>				
141446	350-10-7	1000lb (450 kg) x 0.2lb (0.1 kg)	60 lb	995.00

## Options/Accessories

PART #	DESCRIPTION	PRICE
133077	9V AC adapter, 120V/230V auto switching †	\$15.00
102508	9V AC adapter, 230V ††	20.00

DIMENSIONS			
Wheelchair Platform Scale			
A	32 in	D	9.25 in
B	29.5 in	E	37.5 in
C	2.375 in	F	N/A



Wheelchair Platform Scale Model 350-10-7

## APPROVALS



† NEMA 1-15 Plug

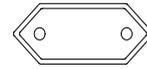

†† CEE 7/16 Euro Plug

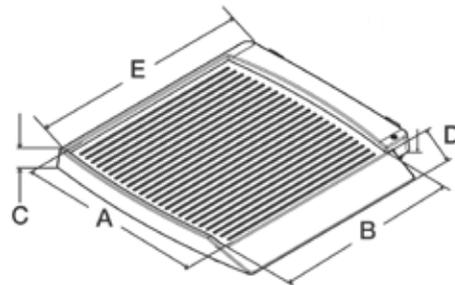

# Wheelchair Scale

## Standard Features

- Capacity: 1000 lb x 0.2 lb (450 kg x 0.1 kg)
- Platform dimensions: 29.5 in x 32 in
- Dual ramp for on-off access
- Two wheels for portability ease
- Motiontrap™ (movement compensation technology)
- Large 1 inch LCD display
- Ability to manually enter the tare weight of a wheelchair
- BMI (body mass index) function
- Hold function
- Unit of measure: lb only, kg only, Lb/Kg
- EMR capable, USB

## Specifications

### Power:

9VDC, provided by six "AA" alkaline batteries (included) or AC adapter (optional)

### Battery Type:

Six "AA" alkaline

### Battery Use:

25 hours continuous use with batteries

### Operating Temperature:

50°F to 104°F (14°C to 40°C)

### Warranty:

Two-year limited warranty

### Approvals:

CE

## Part Number/Price

PART #	MODEL	CAPACITY	EST. SHIP WEIGHT	PRICE
<b>Wheelchair Scale</b>				
141447	350-10-3	1000 lb (450 kg) x 0.2 lb (0.1 kg)	75 lb	\$1,595.00

## Options/Accessories

PART #	DESCRIPTION	PRICE
133077	9V AC adapter, 120V/230V auto switching †	\$15.00
102508	9V AC adapter, 230V ††	20.00

## DIMENSIONS

<b>Wheelchair Scale</b>			
A	48.5 in	D	9.25 in
B	29.5 in	E	38 in
C	2.375 in	F	45 in
<b>Wheelchair Platform Scale</b>			
A	48.5 in	D	9.25 in
B	29.5 in	E	38 in
C	2.375 in	F	N/A



Dual Ramp Wheelchair Model 350-10-3

## APPROVALS



† NEMA 1-15 Plug

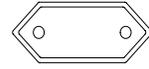

†† CEE 7/16 Euro Plug

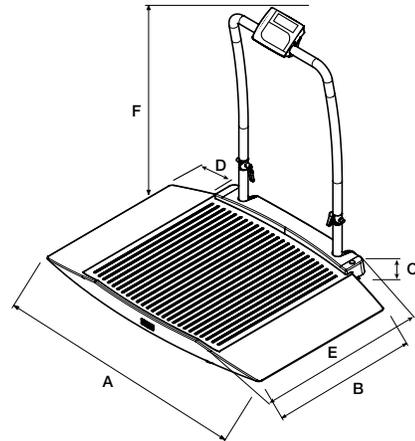

Model 350-10-3

# Wheelchair Scale

## Standard Features

- Capacity: 1000 lb x 0.2 lb (450 kg x 0.1 kg)
- Platform dimensions: 29.5 in x 32 in
- Dual ramp for on-off access
- Two wheels for portability ease
- Motiontrap™ (movement compensation technology)
- Large 1 inch LCD display
- Ability to manually enter the tare weight of a wheelchair
- BMI (body mass index) function
- Hold function
- Unit of measure: lb only, kg only, Lb/Kg
- EMR capable, USB
- Includes padded, fold away chair with back rest

## Specifications

- Power:**  
9VDC, provided by six "AA" alkaline batteries (included) or AC adapter (optional)
- Battery Type:**  
Six "AA" alkaline
- Battery Use:**  
25 hours continuous use with batteries
- Operating Temperature:**  
50°F to 104°F (14°C to 40°C)
- Warranty:**  
Two-year limited warranty
- Approvals:**  
CE

## Part Number/Price

PART #	MODEL	CAPACITY	EST. SHIP WEIGHT	PRICE
<b>Wheelchair Scale with Chair Seat</b>				
141448	350-10-4	1000 lb (450 kg) x 0.2 lb (0.1 kg)	85 lb	\$2,295.00

## Options/Accessories

PART #	DESCRIPTION	PRICE
133077	9V AC adapter, 120V/230V auto switching †	\$15.00
102508	9V AC adapter, 230V ††	20.00

DIMENSIONS			
<b>Wheelchair Scale</b>			
A	48.5 in	D	9.25 in
B	29.5 in	E	38 in
C	2.375 in	F	45 in
<b>Wheelchair Platform Scale</b>			
A	48.5 in	D	9.25 in
B	29.5 in	E	38 in
C	2.375 in	F	N/A



Dual Ramp Wheelchair Platform with Chair Seat  
Model 350-10-4

## APPROVALS



† NEMA 1-15 Plug

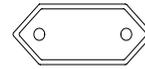

†† CEE 7/16 Euro Plug

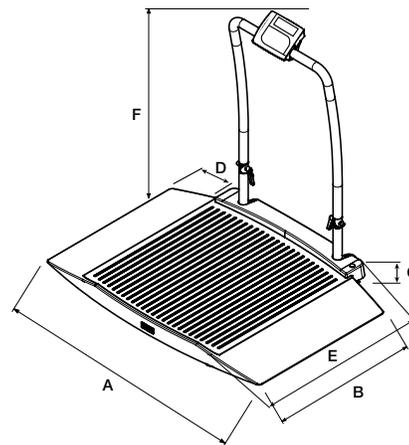

Model 350-10-3

# Wheelchair Scale

## Standard Features

- Capacity: 1000 lb x 0.2 lb (450 kg x 0.1 kg)
- Platform dimensions: 29.5 in x 32 in
- Dual ramp for on-off access
- Two wheels for portability ease
- Motiontrap™ (movement compensation technology)
- Large 1 inch LCD display
- Ability to manually enter the tare weight of a wheelchair
- BMI (body mass index) function
- Hold function
- Unit of measure: lb only, kg only, Lb/Kg
- EMR capable, USB
- 6.5ft cable between scale base and indicator

## Specifications

### Power:

9VDC, provided by six "AA" alkaline batteries (included) or AC adapter (optional)

### Battery Type:

Six "AA" alkaline

### Battery Use:

25 hours continuous use with batteries

### Operating Temperature:

50°F to 104°F (14°C to 40°C)

### Warranty:

Two-year limited warranty

### Approvals:

CE

## Part Number/Price

PART #	MODEL	CAPACITY	EST. SHIP WEIGHT	PRICE
<b>Dual Ramp Wheelchair Platform Scale</b>				
141449	350-10-8	1000 lb (450 kg) x 0.2 lb (0.1 kg)	63 lb	\$1,550.00

## Options/Accessories

PART #	DESCRIPTION	PRICE
133077	9V AC adapter, 120V/230V auto switching †	\$15.00
102508	9V AC adapter, 230V ††	20.00

## DIMENSIONS

Wheelchair Platform Scale			
A	48.5 in	D	9.25 in
B	29.5 in	E	38 in
C	2.375 in		



Dual Ramp Wheelchair Platform Model 350-10-8

## APPROVALS



† NEMA 1-15 Plug

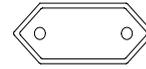

†† CEE 7/16 Euro Plug

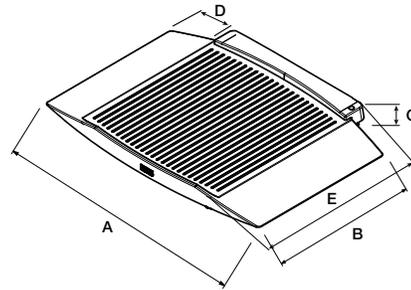

# Wheelchair Scale

Single Ramp with Wheel Stop

## Standard Features

- Capacity: 1000 lb x 0.2 lb (450 kg x 0.1 kg)
- Platform dimensions: 34 in x 34 in
- Anti slip rubber surface on platform
- Two integral handles and wheels for portability ease
- Motiontrap™ (movement compensation technology)
- Large 1 inch LCD display
- Ability to manually enter the tare weight of a wheelchair
- BMI (body mass index) function
- Hold function
- Unit of measure: lb only, kg only, Lb/Kg
- EMR capable, USB
- 10 ft cable between scale base and indicator

## Specifications

**Power:**

9VDC, provided by six "AA" alkaline batteries (included) or AC adapter (optional)

**Battery Type:**

Six "AA" alkaline

**Battery Use:**

25 hours continuous use with batteries

**Operating Temperature:**

50°F to 104°F (14°C to 40°C)

**Warranty:**

Two-year limited warranty

**Approvals:**

CE

## Part Number/Price

PART #	MODEL	CAPACITY	EST. SHIP WEIGHT	PRICE
150703	RL-350-5	1000 lb (450 kg) x 0.2 lb (0.1 kg)	135 lb	\$1,595.00

## Options/Accessories

PART #	DESCRIPTION	PRICE
133077	9V AC adapter, 120V/230V auto switching †	\$15.00
102508	9V AC adapter, 230V ††	20.00

## DIMENSIONS

A	41 in	D	34 in
B	40 in	E	34 in
C	2.22 in		

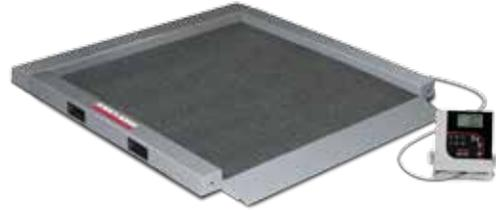

Single Ramp with Wheel Stop Model RL-350-5

## APPROVALS



† NEMA 1-15 Plug

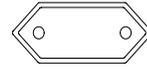

†† CEE 7/16 Euro Plug

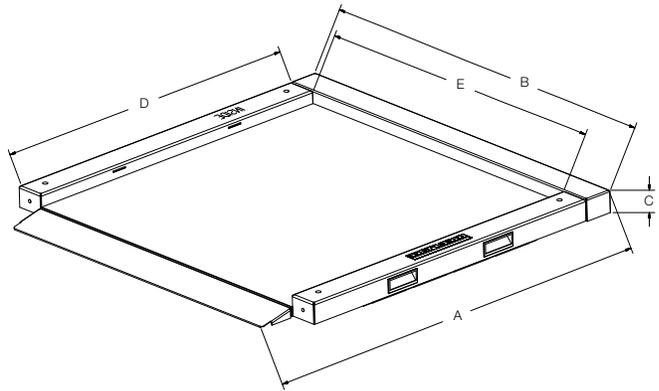

Model RL-350-6



# Wheelchair Scale

Dual Ramp

## Standard Features

- Capacity: 1000 lb x 0.2 lb (450 kg x 0.1 kg)
- Platform dimensions: 34 in x 34 in
- Anti slip rubber surface on platform
- Two integral handles and wheels for portability ease
- Motiontrap™ (movement compensation technology)
- Large 1 inch LCD display
- Ability to manually enter the tare weight of a wheelchair
- BMI (body mass index) function
- Hold function
- Unit of measure: lb only, kg only, Lb/Kg
- EMR capable, USB
- 10 ft cable between scale base and indicator

## Specifications

### Power:

9VDC, provided by six "AA" alkaline batteries (included) or AC adapter (optional)

### Battery Type:

Six "AA" alkaline

### Battery Use:

25 hours continuous use with batteries

### Operating Temperature:

50°F to 104°F (14°C to 40°C)

### Warranty:

Two-year limited warranty

### Approvals:

CE

## Part Number/Price

PART #	MODEL	CAPACITY	EST. SHIP WEIGHT	PRICE
150704	RL-350-6	1000 lb (450 kg) x 0.2 lb (0.1 kg)	135 lb	\$1,595.00

## Options/Accessories

PART #	DESCRIPTION	PRICE
133077	9V AC adapter, 120V/230V auto switching †	\$15.00
102508	9V AC adapter, 230V ††	20.00

DIMENSIONS			
A	41 in	D	34 in
B	40 in	E	34 in
C	2.22 in		

Motiontrap

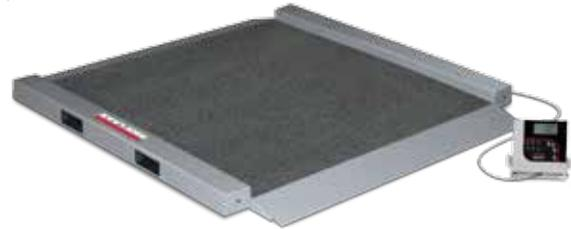

Dual Ramp Model RL-350-6

## APPROVALS



† NEMA 1-15 Plug

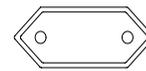

†† CEE 7/16 Euro Plug

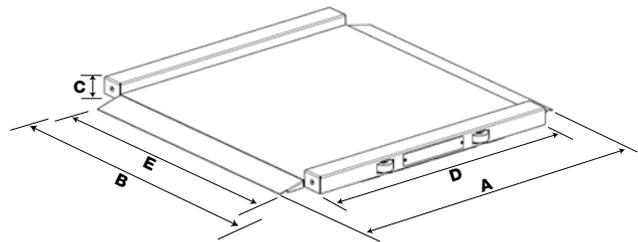

Model RL-350-6

# Wheelchair Scale

## Standard Features

- 36 in W x 36 in L - 1,000 lb mild steel painted scale with anti-slip rubber surface and three-sided safety rails
- Access ramp 36 in W x 28.5 in L with anti-slip rubber surface
- Motiontrap™ (movement compensation technology)
- Large 1 inch LCD display
- Pushbutton or manual entry of tare weight
- Unit of measure: lb only, kg only, Lb/Kg
- 10 ft interface cable from scale to indicator
- EMR capable, USB
- BMI (body mass index) function
- Hold function

## Specifications

**Power:**

9VDC, provided by six "AA" alkaline batteries (included) or AC adapter (optional)

**Battery Type:**

Six "AA" alkaline

**Battery Use:**

25 hours, continuous use with batteries

**Operating Temperature:**

50°F to 104°F (14°C to 40°C)

**Warranty:**

Two-year limited warranty

**Approvals:**

CE

## Part Number/Price

PART #	MODEL	CAPACITY	EST. SHIP WEIGHT	PRICE
150706	SB-1150	1000 lb (450 kg) x 0.2lb (0.1 kg)	370 lb	\$1,495.00

## Options/Accessories

PART #	DESCRIPTION	PRICE
133077	9V AC adapter, 120V/230V auto switching †	\$15.00
102508	9V AC adapter, 230V ††	20.00

DIMENSIONS			
A	36 in	D	36 in
B	36 in	E	4 in
C	28.5 in	F	1 in



Model SB-1150

## APPROVALS



† NEMA 1-15 Plug

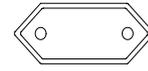

†† CEE 7/16 Euro Plug

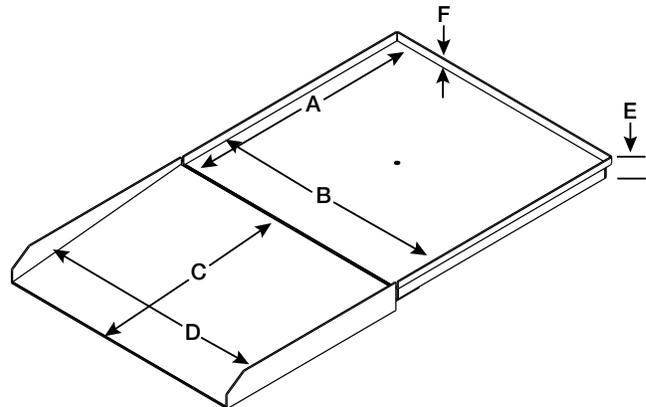

# Wheelchair Scale

## Standard Features

- 36 in W x 36 in L - 1,000 lb mild steel painted scale with anti-slip rubber surface
- 36 in H x 30 in L handrail and mounting hardware
- 36 in W x 36 in L - mild steel painted pit frame
- Large 1 inch LCD display
- Push button or manual entry of tare weight
- Unit of measure: lb only, kg only, Lb/Kg
- 10 ft interface cable from scale to indicator
- EMR capable, USB
- BMI (body mass index) function
- Hold function

## Specifications

### Power:

9VDC, provided by six "AA" alkaline batteries (included) or AC adapter (optional)

### Battery Type:

Six "AA" alkaline

### Battery Use:

25 hours continuous use with batteries

### Operating Temperature:

50°F to 104°F (14°C to 40°C)

### Warranty:

Two-year limited warranty

### Approvals:

CE

## Part Number/Price

PART #	MODEL	CAPACITY	EST. SHIP WEIGHT	PRICE
150707	SD-1150-WP	1000 lb (450 kg) x 0.2lb (0.1 kg)	295 lb	\$1,695.00

## Options/Accessories

PART #	DESCRIPTION	PRICE
133077	9V AC adapter, 120V/230V auto switching †	\$15.00
102508	9V AC adapter, 230V ††	20.00

## DIMENSIONS

A	36 in	D	31.5 in
B	36 in	E	37 in
C	3 in		



Model SD-1150-WP

## APPROVALS

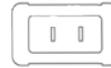

† NEMA 1-15 Plug

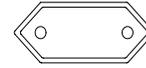

†† CEE 7/16 Euro Plug

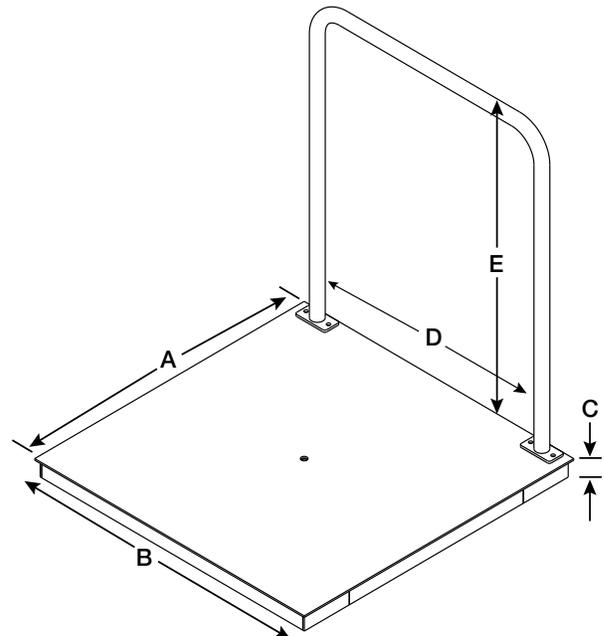

# Wheelchair Scale

## Pit Frame Concrete Details

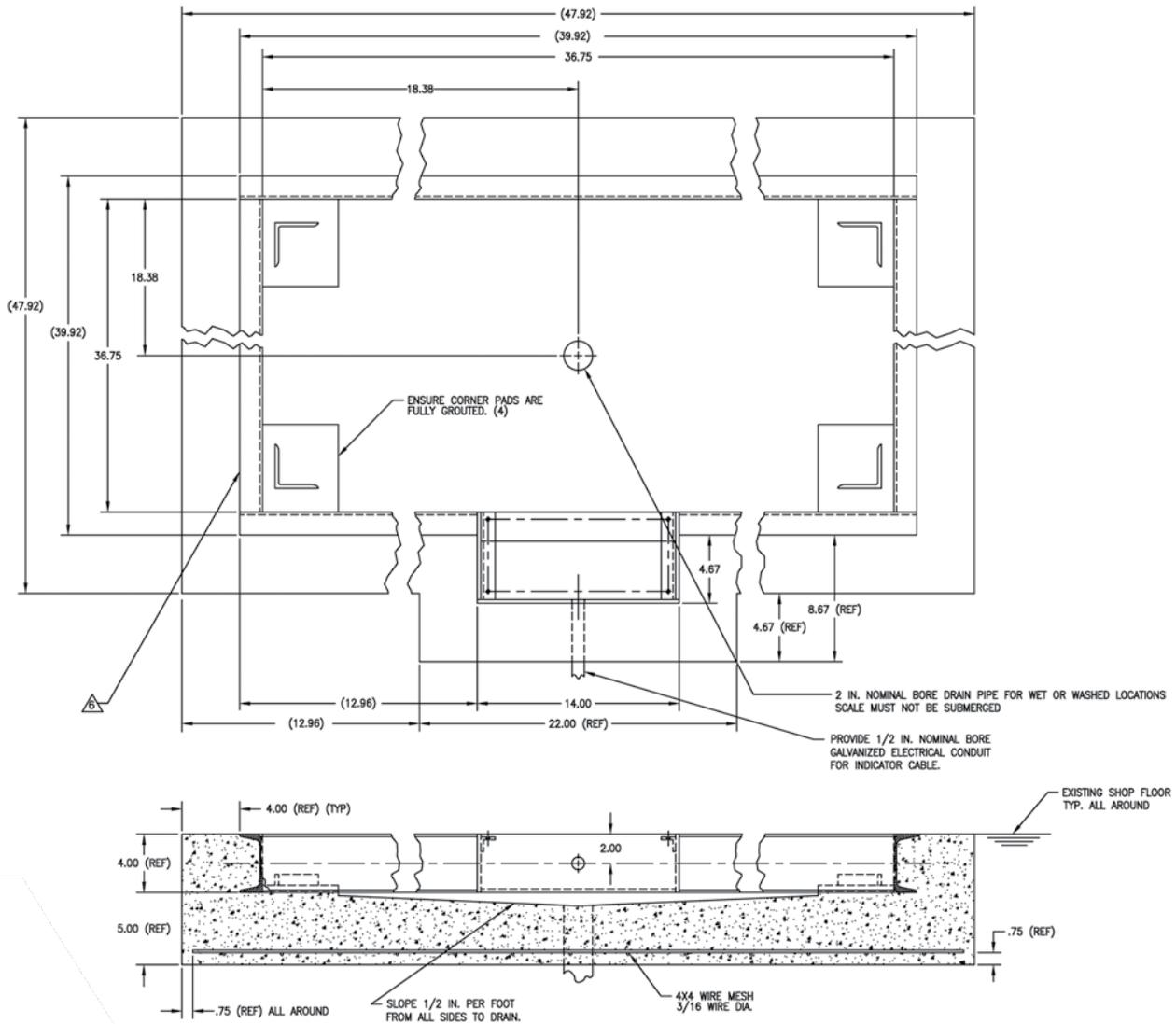

**NOTE:**

1. USE CONCRETE OF MINIMUM YIELD STRENGTH 5000 PSI OR 6-BAG MIX.
  2. ALLOW 7 DAYS TO CURE. WET CONCRETE PERIODICALLY DURING THIS TIME.
  3. DIMENSIONS SHOWN ASSUME FIRM, STABLE SOIL CONDITIONS. WHEN SOIL CONDITIONS ARE NOT ADEQUATE, PLACE FOUNDATION AT SUFFICIENT DEPTH.
  4. IN WET OR WASHDOWN APPLICATIONS WE RECOMMEND THE USE OF HERMETICALLY SEALED LOAD CELLS, AND THAT THE JUNCTION BOX BE MOUNTED REMOTELY IN A DRY LOCATION.
  5. WIRE MESH TO HAVE MINIMUM .75 COVER BOTTOM AND SIDES.
- △ ON STAINLESS STEEL VERSIONS, TWO PIECES OF 2 INCH ANGLE WILL BE SUBSTITUTED FOR THE 4 INCH CHANNEL.

# Wireless Bed Scale

## Standard Features

- Four scale pads
- One handheld controller
- Four wheel stops
- Four roll-up ramps
- One bed rail controller mount
- Simple user interface
- Compact and lightweight

## Specifications

### Capacity:

800 lb x 0.1 lb (363 kg x 0.2 kg)  
1,200 lb x 0.5 lb (544 kg x 0.2 kg)

### Power:

Eight EL-123 batteries per scale system two per pad (included)  
Three "AAA" lithium batteries (included) for handheld controller

### Construction:

Powder coated molded plastic and cast aluminum

### Operating Temperature:

50°F to 95°F (14°C to 35°C)

### Warranty:

Two-year limited warranty

### Approvals:

CE

## Part Number/Price

PART #	MODEL	CAPACITY	EST. SHIP WEIGHT	PRICE
158216	D1100-8	800 lb x 0.5 lb (363 kg x 0.05 kg)	15 lb	\$2,495.00
157222	D1100-12	1,200 lb x 0.5 lb (544 kg x 0.02 kg)	15 lb	3,295.00

## Options/Accessories

PART #	DESCRIPTION	PRICE
158229	Lanyard	\$5.00
158230	Rubber controller glove	10.00



Model D1100

## APPROVALS



Bed Positioned on Pads



Bedrail Mount



# Dietary Scale

## Standard Features

- Six-digit LCD display
- Powered by two "D" cell batteries\* (up to 500 hours operation)
- Auto power-off function
- Low battery indicator
- Overload stops

## Specifications

### Display:

Six digits (7-segment), LCD  
Character height: 1 in (25.4 mm)

### Keyboard:

Zero, tare, on/off, unit (Lb/Kg)  
NOTE: oz version only displays weight in oz

### Power:

Two dry cell "D" type batteries\* (up to 500 hours) or AC adapter  
Auto power-off function (can be set to 60 min., 20 min., or off)

### Divisions (Auto Ranging):

100 oz: 0.05 oz from 0–50 oz, 0.1 oz from 50–100 oz  
6 lb (3 kg): 0.002 lb (0.001 kg) from 0–3 lb (0–1.5 kg), 0.005 lb (0.002 kg) from 3–6 lb (1.5–3 kg)  
15 lb (6 kg): 0.005 lb (0.002 kg) from 0–6 lb (0–3 kg), 0.01 lb (0.005 kg) from 6–15 lb (3–6 kg)  
30 lb (15 kg): 0.01 lb (0.005 kg) from 0–15 lb (0–7.5 kg), 0.02 lb (0.01 kg) from 15–30 lb (7.5–15 kg)  
60 lb (30 kg): 0.02 lb (0.01 kg) from 0–30 lb (0–15 kg), 0.05 lb (0.02 kg) from 30–60 lb (15–30 kg)

### Operational Temperature:

23°F to 104°F (-5°C to 40°C)

### Platter Size:

100 oz: (3 kg) 9.1 in x 7.8 in (231 mm x 198.1 mm)  
6 lb (3 kg): 9.1 in x 7.8 in (231 mm x 198.1 mm)  
15 lb (6 kg): 9.1 in x 7.8 in (231 mm x 198.1 mm)  
30 lb (15 kg): 11 in x 11.5 in (279.4 mm x 292.1 mm)  
60 lb (30 kg): 11 in x 11.5 in (279.4 mm x 292.1 mm)

### Warranty:

One-year limited warranty

### Approvals:

NTEP Certified CC 02-139, Class III  
0-30 lb 1500d; 60 lb 1200d; 0-100 oz 1000d  
UL listed

## Part Number/Price

PART #	CAPACITY	DIMENSIONS	EST. SHIP WEIGHT	PRICE
<b>Single display</b>				
75466	100 oz (3 kg)	9.1 in x 7.8 in	6 lb	\$230.00
<b>Single display, multi-ranging</b>				
75454	6 lb (3 kg)	9.1 in x 7.8 in	6 lb	230.00
75455	15 lb (6 kg)	9.1 in x 7.8 in	6 lb	230.00
75457	30 lb (15 kg)	11 in x 11.5 in	8 lb	230.00
75458	60 lb (30 kg)	11 in x 11.5 in	8 lb	230.00

## Options/Accessories

PART #	DESCRIPTION	PRICE
75470	Stainless steel platter cover (100 oz, 6 lb, and 15 lb capacity)	\$20.00
75739	Stainless steel platter cover (30 lb and 60 lb capacity)	20.00
75473	AC adapter	19.00



Model iPC

## APPROVALS

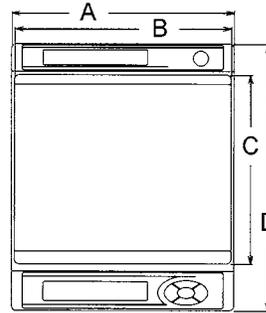

iPC 9.1" x 7.8" platter

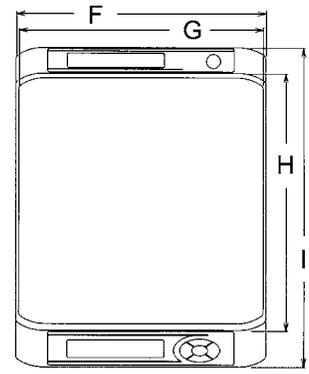

iPC 11" x 11.5" platter

DIMENSIONS			
A	9.3 in (236.2 mm)	F	11.3 in (287 mm)
B	9.1 in (231.1 mm)	G	11 in (279.4 mm)
C	7.8 in (198.1 mm)	H	11.5 in (292.1 mm)
D	11.1 in (281.9 mm)	I	14.3 in (363.2 mm)
E	3.9 in (99.1 mm)	J	4 in (101.6 mm)

\* Batteries and AC adapter not included

# Body Composition Analyzer

## Standard Features

- Multi frequency full body composition obtained from BIA, bio-electrical impedance analysis through scale base electrodes and handheld electrodes
- Capacity: 440 x 0.2 lb/200 x 0.1 kg
- Platform dimensions: 14.5 x 14 x 4 in
- User configurable mode: adult and athlete mode, wrestler, goal setter, weight only
- Built-in thermal printer
- USB terminal and RS-232 port for computer interface
- Includes AC adapter and two rolls of thermal printer paper

## Specifications

### Power Supply:

12V AC adapter

### Frequency:

50, 150, 250 K Hz

### Test Duration:

Approximately 60 seconds

### Height Range:

3 ft to 7 ft 11.5 in x 0.5 in increments  
(90 cm to 249 cm x 1 cm)

### Body Fat Range:

1% to 75% x 0.1% increments

### BMR:

1 kcal increments

### Impedance Measurement Range:

150–900 ohms

### Operating Temperature:

50°F to 104°F (14°C to 40°C)

### Warranty:

Two-year limited warranty

### Approvals:

FDA, 510 K pending

## Part Number/Price

PART #	MODEL	CAPACITY	EST. SHIP WEIGHT	PRICE
151116	D1000-3	440 lb (200 kg) x 0.2 lb (0.1 kg)	33 lb (15 kg)	\$3,295.00

## Options/Accessories

PART #	DESCRIPTION	PRICE
152984	Column kit	\$400.00
158046	Body pass software	295.00
75947	Replacement paper, 85 ft long, direct thermal	6.00



**Full Body!**

Model D1000-3



Shown with optional column kit

# Body Composition Analyzer

## Standard Features

- Single frequency lower body composition obtained from BIA, bio-electrical impedance analysis through scale base electrodes
- Capacity: 440 x 0.2 lb/200 x 0.1 kg
- Platform dimensions: 14.5 x 14 x 4 in
- User configurable mode: adult and athlete mode, wrestler, goal setter, weight only
- Built-in thermal printer
- USB terminal and RS-232 port for computer interface
- Includes AC adapter and two rolls of thermal printer paper



Model D1000-1



## Specifications

**Power Supply:**  
12V AC adapter

**Frequency:**  
50 K Hz

**Test Duration:**  
Approximately 60 seconds

**Height Range:**  
3 ft to 7 ft 11.5 in x 0.5 in increments  
(90 cm to 249 cm x 1 cm)

**Body Fat Range:**  
1% to 75% x 0.1% increments

**BMR:**  
1 kcal increments

**Impedance Measurement Range:**  
150–900 ohms

**Operating Temperature:**  
50°F to 104°F (14°C to 40°C)

**Warranty:**  
Two-year limited warranty

**Approvals:**  
FDA, 510 K pending

## Part Number/Price

PART #	MODEL	CAPACITY	EST. SHIP WEIGHT	PRICE
151115	D1000-1	440 lb (200 kg) x 0.2 lb (0.1 kg)	33 lb (15 kg)	\$2,595.00

## Options/Accessories

PART #	DESCRIPTION	PRICE
152984	Column kit	\$400.00
158046	Body pass software	295.00
75947	Replacement paper, 85 ft. long, direct thermal	6.00



# Body Composition Analyzer

## Standard Features

- Single frequency upper body composition obtained from BIA, bio-electrical impedance analysis through handheld electrodes
- Capacity: 440 x 0.2lb/200 x 0.1 kg
- Platform dimensions: 14.5 x 14 x 4 in
- User configurable mode: adult and athlete mode, wrestler, goal setter, weight only
- Built-in thermal printer
- USB terminal and RS-232 port for computer interface
- Includes AC adapter and two rolls of thermal printer paper

## Specifications

### Power Supply:

12V AC adapter

### Frequency:

50 K Hz

### Test Duration:

Approximately 60 seconds

### Height Range:

3ft to 7ft 11.5in x 0.5in increments  
(90 cm to 249 cm x 1 cm)

### Body Fat Range:

1% to 75% x 0.1% increments

### BMR:

1 kcal increments

### Impedance Measurement Range:

150–900 ohms

### Operating Temperature:

50°F to 104°F (14°C to 40°C)

### Warranty:

Two-year limited warranty

### Approvals:

FDA, 510K pending

## Part Number/Price

PART #	MODEL	CAPACITY	EST. SHIP WEIGHT	PRICE
151114	D1000-2	440 lb (200 kg) x 0.2 lb (0.1 kg)	33 lb (15 kg)	\$2,595.00

## Options/Accessories

PART #	DESCRIPTION	PRICE
152984	Column kit	\$400.00
158046	Body pass software	295.00
75947	Replacement paper, 85 ft. long, direct thermal	6.00



Model D1000-2





# Monorail Scales

Table of Contents

**MS200 and MS202** ..... **646**  
Portable and Permanent Monorail Scales

**ESPAÑOL** | Visit [ricelake.com/spanish](http://ricelake.com/spanish)  
to see all RLWS materials  
available in Spanish

Product names, logos, brands, and other trademarks featured  
or referred to within this publication are the property of their respective trademark holders.

# MS200 and MS202

Portable and Permanent Monorail Scales

## Standard Features

- 8 inch long live rail designed to weigh one trolley at a time
- 750 lb x .5 lb resolution in both portable and permanent models
- Available for rail sizes 3/8 in x 2 1/2 in or 1/2 in x 2 1/2 in
- Requires less than 41 inches of straight rail to install (14 inch between rail hangers for permanent model)
- Zinc-plated, steel construction
- High accuracy, stainless steel load cell
- 25 ft of load cell cable for flexible installation
- Slightly recessed live rail for the trolley roller provides stable weighments

## Specifications

### MS200/MS202 Construction:

Zinc-plated steel construction, stainless steel hardware

### Load Cell Construction:

Stainless steel

### Bridge Resistance:

350 ohms nominal

### Rated Output:

2 mV/V

### Nonlinearity:

0.03% full scale

### Approvals:

NTEP CC 90-003, Class III, nmax 1500

## Part Number/Price

PART #	DESCRIPTION	WEIGHT	PRICE
19743*	MS200HB, NTEP Certified portable	38 lb	\$1,610.00
19744*	MS202HB-3/8 in, NTEP Certified permanent	38 lb	1,610.00
19745*	MS202HB-1/2 in, NTEP Certified permanent	38 lb	1,610.00

\*Scale only, indicator not included

## Options/Accessories

PART #	DESCRIPTION	PRICE
16984	Additional operating manual	\$5.00

NOTE: If scale is not going to be moved to different locations, the MS-202 permanent model is recommended for easier transfer of the load.



## APPROVALS

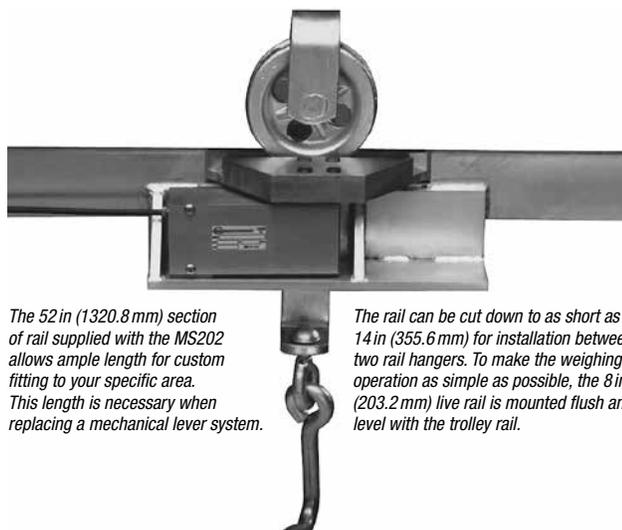

The 52 in (1320.8 mm) section of rail supplied with the MS202 allows ample length for custom fitting to your specific area. This length is necessary when replacing a mechanical lever system.

The rail can be cut down to as short as 14 in (355.6 mm) for installation between two rail hangers. To make the weighing operation as simple as possible, the 8 in (203.2 mm) live rail is mounted flush and level with the trolley rail.

MS202 Permanent Monorail Scale

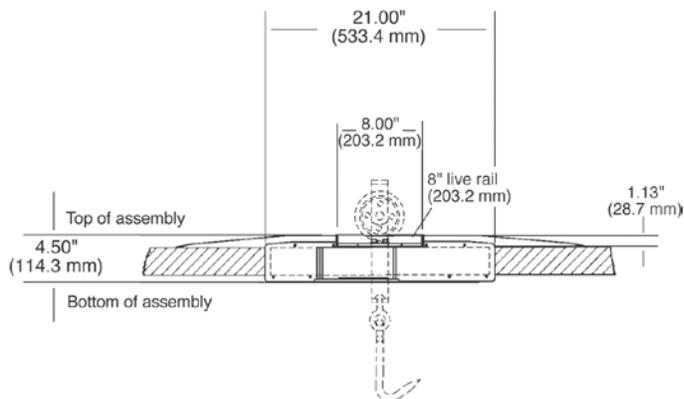

MS200/MS202 Dimensions

# Onboard Weighing

## Table of Contents

<b>Precision Loads</b> .....	<b>648</b>
Semi Trailer Kits	
<b>Precision Loads</b> .....	<b>649</b>
Straight Truck Kits	
<b>Precision Loads</b> .....	<b>650</b>
Replacement/SVC Parts	
<b>TradeRoute™ HL Series</b> .....	<b>652</b>
Legal for Trade Onboard Weighing System	
<b>Loadrunner™ Onboard Weighing Systems</b> .....	<b>655</b>
Roll-Off Systems Kit	
<b>Loadrunner™ Onboard Weighing Systems</b> .....	<b>656</b>
Dump Truck Systems Kit	

**ESPAÑOL** | Visit [ricelake.com/spanish](http://ricelake.com/spanish)  
to see all RLWS materials  
available in Spanish

Product names, logos, brands, and other trademarks featured or referred to within this publication are the property of their respective trademark holders.

# Precision Loads

## Semi Trailer Kits

### Part Number/Price

PART #	MODEL #	DESCRIPTION	PRICE
<b>Complete Tractor/Trailer Air-ride Kits</b>			
114285	PL9700-100	Single Transducer Kit for Tractor/Trailer Kit Includes: 9700, Air Transmitter (2), Air Pressure Transducer (2), 35 ft & 80 ft Truck cable, 15 ft power cable	\$2,830.00
114286	PL9700-200	Dual Transducer Kit for Tractor/Trailer Kit Includes: 9700, Air Transmitter 2 lead (2), Dual Air Pressure Transducer (2), 35 ft & 80 ft Truck cable, 15 ft power cable	3,300.00
114287	PL9704-3202	Three Channel Air Transducer System Kit Includes: 9704, Air Transmitter 2 lead (3), Dual Air Pressure Transducer (3), 35 ft & 80 ft (2) Truck cable, 15 ft power cable	4,600.00
114288	PL9704-4202	Four Channel Air Transducer System Kit Includes: 9704, Air Transmitter 2 lead (4), Dual Air Pressure Transducer (4), 35 ft & 80 ft (3) Truck cable, 15 ft power cable	6,000.00
114289	PL9704A-3202	Three Channel Air Transducer System with Auto ID Indicator/Transmitter Kit Includes: 9704A, Air Transmitter 2 lead Auto ID(3), Dual Air Pressure Transducer (3), 35 ft & 80 ft (2) Truck cable, 15 ft power cable	4,800.00
114290	PL9704A-4202	Four Channel Air Transducer System with Auto ID Indicator Kit Includes: 9704A, Air Transmitter 2 lead Auto ID(4), Dual Air Pressure Transducer (4), 35 ft & 80 ft (3) Truck cable, 15 ft power cable	6,100.00
<b>Half System Air-Ride Kits</b>			
114292	PL9701-200	Dual Transducer Kit for Tractor Only Kit Includes: 9700, Air Transmitter 2 lead LC, Dual Air Pressure Transducer, 35 ft & 80 ft Truck cable, 15 ft power cable	2,100.00
114294	PL9701-200	Dual Transducer Kit for Trailer Only Kit Includes: Air Transmitter 2 lead LC, Dual Air Pressure Transducer, 80 ft Truck cable	1,200.00
<b>Half System 5th Wheel Kits</b>			
114295	PL9701-250H	Holland Fixed 5th Wheel Kit (25,000 lb Max with dead load) Kit Includes: 9700, Dual Lead Transmitter ,(2) 5th wheel bending beam/suspension load cell, 35 ft Truck cable, 15 ft power cable, hardware	3,900.00
114296	PL9701-250F	Fontaine Fixed 5th Wheel Kit (25,000 lb Max with dead load) Kit Includes: 9700, Dual Lead Transmitter, (2) 5th wheel bending beam/suspension load cell, 35 ft Truck cable, 15 ft power cable, hardware	3,800.00
132050	PL9701-250J	Jost fixed 5th wheel kit (25,000 lb max with dead load) Kit Includes: 9700, Dual Lead Transmitter, (2) 5th wheel bending beam/suspension load cell, 35 ft Truck cable, 15 ft power cable, hardware	4,200.00
<b>Equalizing Leaf Spring Suspension Kits</b>			
114299	PL9720-250	Tandem Center Hanger Load Cell Kit (25,000 lb Max with dead load) Kit Includes: Dual Lead Load Cell Transmitter, (2) 5th wheel bending beam/suspension load cell, 80 ft Truck cable, (4) bearing plates, hardware	2,700.00
114300	PL9720-450	Tandem Tri-Axle Center Hanger Load Cell Kit (25,000 lb Max with dead load) Kit Includes: Four Lead Load Cell Transmitter, (4) 5th wheel bending beam/suspension load cell, 80 ft Truck cable, (8) bearing plates, hardware	4,600.00
163091		Hutch center equalizer hanger for tandem/triaxle kit Kit Includes: Two hangers	2,100.00
<b>Tandem Trailer Single-Point Suspension Kits</b>			
117667	PL9720-216	Single Point Clamp Load Cell Kit, 40 K (80,000lb Max with dead load) Kit Includes: Dual Lead Transmitter, (2) Bearing Plates, (2) 40 K Load Cells,(8) Bearing Plates	3,350.00
161660		Single Point Clamp Load Cell Kit, 40 K (80,000lb Max with dead load) Kit Includes: (2) 40K Load Cells, (4) Body Springs, (2) Nuts, Bolts and Washers, Bearing Plates	2,650.00
<b>Indicator Kits</b>			
114163	PL9700-02	Dual Channel Indicator Kit Kit Includes: 9700, (2) Dual Lead Transmitter, 35 ft & 80 ft Truck cable, 15 ft power cable	2,100.00
114174	PL9710-02	Dual Channel Indicator Air Kit with Serial Ports Kit Includes: 9710, 2 Lead Transmitter, 2 Lead Air Transmitter	2,450.00
114304	PL9704-03	Three Channel Indicator Air Kit with Serial Ports Kit Includes: 9704, (3) 2 Lead Air Transmitter, 35 ft & (2) 80 ft Truck cables, 15 ft power cable	3,250.00
114305	PL9704-04	Four Channel Indicator Air Kit with Serial Ports Kit Includes: 9704, (4) 2 Lead Air Transmitter, 35 ft & (3) 80 ft Truck cables, 15 ft power cable	3,625.00

# Precision Loads

## Straight Truck Kits

### Part Number/Price

PART #	MODEL #	DESCRIPTION	PRICE
<b>Ridgid Underbody Load Cell Kits</b>			
114307	PL9710-414.4	Four Point Indicator Kit with 14.4 in Load Cells (50,000 lb Max with dead load) Kit Includes: 9710, Four Lead Transmitter, (4) 14.4 in Load Cell,(4) Bearing Plates, (4) Body Coil Springs, 35 ft Truck cable, 15 ft Power Cable	\$5,695.00
114308	PL9710-614	Six Point Indicator Kit with 14.4 in Load Cells (75,000 lb Max with dead load) Kit Includes: 9710, Six Lead Transmitter, (6) 14.4 in Load Cell,(6) Bearing Plates, (8) Body Coil Springs, Anti Rotation plate, 35 ft Truck cable, 15 ft Power Cable	7,500.00
114309	PL9710-426	Four Point Indicator Kit with 26 in load cells (50,000 lb Max with dead load) Kit includes: 9710, Four Lead Transmitter, (4) 26 in Load Cells, (8) Bearing Plates, (6) Body Coil Springs, 35 ft Truck Cable, 15 ft Power Cable	7,000.00
161660		Single Point Clamp Load Cell Kit, 40 K (80,000lb Mas with dead load) Kit Includes: (2) 40K Load Cells, (4) Body Springs, Nuts, Bolts and Washers, Bearing Plates	2,650.00
<b>Tiping Body/Hoist Chassis Kits</b>			
118572		Six Point Pivot Pin Kit with Groove Lock Load Cells, Live Weigh Kit Includes: 9710, 6 Lead Transmitter, 35 ft Truck cable, 15 ft power cable, 94) Bearing Plates, (4) Shear Beam Underbody Load Cells. (4) Groove Lock Kits, (2) Labrie Hinge Pin Kits] (50,000 lb Max with dead load)	8,400.00
<b>Air Ride Kits</b>			
114313	PL9700-1200	Dual Transducer/Transmitter Air Ride Kit Kit Includes: 9700, 2 Lead Air Transmitter, Air Pressure Transducer, 35 ft Truck cable, 15 ft power cable	2,100.00
119287		GPS Indicator Kit Kit Includes: 9700/ RS-232 and GPS Serial Output, (2) Dual Lead Air Transmitters, Wireless Transceiver, Wireless Receiver, 35 ft Truck cable, 15 ft power cable	3,095.00
<b>Indicator Kits</b>			
114176	PL9710-04	Four Point Indicator Kit with Serial Ports Kit Includes: 9710, Four Lead Transmitter, 35 ft Truck cable, 15 ft power cable	2,000.00
114177	PL9710-06	Six Point Indicator Kit with Serial Ports Kit Includes: 9710, 6 Lead Transmitter, 35 ft Truck cable, 15 ft power cable	2,125.00

# Precision Loads

Replacement/SVC Parts

## Part Number/Price

PART #	MODEL #	DESCRIPTION	PRICE
<b>Replacement Parts</b>			
114185	PL9700-10	In Cab, Dual Channel, Gross Net	\$895.00
114186	PL9710-10	In Cab, Single Channel, Load Deliver with Printer Ports	995.00
114187	PL9704-10	In Cab, Four Channel	995.00
114188	PL9705-10	In Cab with Auto Id	995.00
118570	PL9704A	In Cab, Four Channel with Auto ID	1,095.00
119284	PL97000-SF	9700 Indicator with GPS serial output	1,050.00
<b>Options</b>			
119301	601/602	Wireless Kit Eliminates 80 ft cable from installation, includes Receiver and Transmitter	995.00
114316	PL605D	Printek mtP400si Thermal Lister Printer Kit Includes: Printer, mounting bracket, serial & power cable, 2 paper rolls	1,395.00
114319	PL9897	Dual Limit Set Point Remote Relay Module, 9710 only. Compatible with 118572 and 9710. For use when weight 1 is exceeded, activates Signal, exceeds weight 2 set point, activates signal	355.00
75850		Rice Lake Laser Light Remote Display 4 in Digits, Mild Steel, Weatherproof	1,500.00
75852		Rice Lake Laser Light Remote Display 6 in Digits, Mild Steel, Weatherproof	1,950.00
87172		Rice Lake Laser Light Remote Display 4 in Digits, Stainless Steel, Weatherproof	2,000.00
<b>Load Cell Replacement Parts</b>			
116435	PL9000-11	Feed Wagon Cantilever Beam 7,000 lb Replaces 118195 for use on Old Lodec Feed Wagons Limited Stock	480.00
114322	PL9000-14	13 in Low Profile Bending Beam 10,000 lb For use as SI replacement Load Cell	650.00
115345	PL9000-14.4	14.4 inch Under Body Shear Beam 12,500 lb for use on part numbers 114307 or 114308	750.00
111766	PL-9000-22	22.6 in underbody/Axle Scale Load Cell Replaces 114324 for use in Axle Scales, SI Replacement SI830042010	1,050.00
114325	PL9000-26	26 in Shear Beam Load Cell 12,500 lb. For use on 114309 and used as Vulcan® or SI® replacement	885.00
114326	PL9000-50	5th Wheel Bending Beam/ Suspension Load Cell 12,500 lb for use on 114295 and 114296	765.00
117666	PLSB-40K	40K Double Ended Shear Beam Load Cell for use on 117667	945.00
118369	PLSB-40K	40K Double Ended Shear Beam Load Cell and Bearing Plate for use on 117667	1,025.00
<b>Transmitter Replacement Parts</b>			
114189	PL8705	Dual Lead Transmitter, SI® replacement	500.00
118276	PL8701	Single Lead Transmitter, SI replacement	560.00
118217	PL9720-20010	Dual Lead Vulcan® V200 Transmitter	560.00
114190	PL7042	2 Lead L C Transmitter	540.00
114191	PL7052	2 Lead Air Transmitter	540.00
114192	PL8042	2 Lead LC Transmitter with Auto ID	560.00
114193	PL8052	2 Lead Air Transmitter with Auto ID	560.00
114353	PL7154	4 Lead LC Transmitter	650.00
114354	PL7156	6 Lead LC Transmitter	700.00
114196	PL7041	Single Lead LC Transmitter	540.00
114197	PL7051	Single Lead Air Transmitter	540.00
114198	PL8044	4 Lead LC Transmitter with Auto ID	650.00
129993	PL8702	2 Lead LC Transmitter with 8 ft cable, 4 Pin Connector , 90 degree	560.00
<b>Air Transducer Replacement Parts</b>			
114320	PL9000-102	Air Pressure Transducer, Single Element	300.00
114321	PL9000-202	Air Pressure Transducer, Dual Element	500.00



# Precision Loads

Replacement/SVC Parts

## Part Number/Price

PART #	MODEL #	DESCRIPTION	PRICE
<b>Replacement Parts</b>			
119285	601	Wireless Transmitter	\$500.00
119286	602	Wireless Receiver	500.00
26069	PL9000-08CP	Cotter Pin, 1/4 x 2 1/2 zinc plated	1.10
114199	PL9720-35	Cable 2 wire, 35 ft	90.00
114200	PL9720-45	Cable 2 wire, 45 ft	120.00
114201	PL9720-80	Cable 2 wire, 80 ft	150.00
115093	PL9700-15	Power Cable wire, 15 ft	12.00
114240	PL9000-17C	Plated bolt, 3/4 - 16 x 1.50 Grade 8	3.00
114241	PL9000-17D	Plated bolt, 3/4 - 16 x 2.00 Grade 8	3.00
114244	PL9000-17E	Plated bolt, 3/4 - 16 x 4.00 Grade 8	6.00
114249	PL9000-22D	Plated bolt, 1- 14 x 2.50 Grade 8	6.00
114251	PL9000-22C	Plated bolt, 1- 14 x 1.50 Grade 8	5.00
114252	PL9000-22F	Plated bolt, 1- 14 UNF x 4.50 Grade 8	12.00
114342	PL9000-26C	Plated bolt, 1 1/8 in 12 UNF x 3.25 Grade 8	22.00
114343	PL9000-13C	Plated bolt, 1.25- 12 x 2.50 Grade 8	20.00
114243	PL9000-17W	Plated washer F436 , 3 / 4 in	1.00
114254	PL9000-22W	Plated washer F436 , 1 in	3.00
114255	PL9000-13W	Plated washer F436 , 1.25 in	5.00
114256	PL9000-26W	Plated washer F436 , 1 1/8 in	2.00
114332	PL9000-50H	Holland 5th Wheel Trunnion Kit Inc; Bushing, (4) Cap Screws & Washers, Shear Slug, Trunnion	195.00
115104		Holland trunnion 4.25 x 3.11 x 8.6 in	140.00
114236		Holland bushing 2 3/4 (OD) x 1 1/8 (ID) x 4 1/4 in	50.00
114333	PL9000-50F	Fontaine 5th Wheel Trunnion Kit Inc; Bushing, (4) Cap Screws & Washers, Shear Slug, Trunnion	195.00
115328		Fontaine trunnion 3.5 x 9.08 x 5.125 in	140.00
114235		Fontaine bushing 4 (OD) x 1 1/4 (ID) x 2 1/4 in	50.00
131997		Jost trunnion	175.00
132563		Jost bushing	45.00
114334	PL9000-50S	Shear Slug for PN 114326	5.00
114338	PL9000-50B	Bearing plate for PN 114326	30.00
114339	PL9000-14B	Single Bearing plate for PN 114322	80.00
114340	PL9000-24B	Single Bearing plate for PN 114324	20.00
114341	PL9000-26B	Bearing plate for PN 114326	20.00
115309	PL9000-14.4	Single Bearing plate for PN 114345	90.00
114349	PL9000-01S	Body Spring, 3 / 4 in Bolt x 3 in (L) 1800 lb per inch	40.00
114350	PL9000-02S	Body Spring , 1 in Bolt x 3 in (L) 2200 lb per inch	40.00
114357	PL9700-17	6-Pin terminal strip	12.00
118713		Replacement Serial Cable for Printek mtP400si, data and power	75.00
115954		30 ft load cell cable extension, 4 Pin connector to bare wire	85.00

# TradeRoute™ HL Series

Legal for Trade Onboard Weighing System

## Standard Features: System

### Legal for Trade Onboard System Includes:

- 3 or 4 point onboard system RL2000B load cell with 20 ft cable, IP67
- 80 ft conduit cable
- Magnetic transport alarm sensor with 15 ft cable
- JB4SS junction box
- Hydraulic line locks and hoses
- 920i® Onboard Weigh Center

Hydraulic pump not included

Minimum 3,000 PSI recommended to maintain 2200 PSI during lift

### 920i Onboard Weigh Center:

- Epson® TM-U295 printer with splash shield
- Pre-installed 30 ft power cable
- Pre-installed 30 ft load cell cable
- Pre-installed Inclinometer
- Transport alarm LEDs
- Power switch
- Start/End switch
- Waterproof enclosure
- Vibration mounts

Mounting bracket to body not included

### 920i USB Universal with Onboard Software:

- RS-232 port
- Standard onboard software
- USB interface board only

### USB Interface Functions:

- Available upon special request using a Type A sealed connector
- USB interface card on Port 2
- Supports weigh mode and configuration mode functions
- Supports upload of databases and 920 configuration file
- Supports download of databases, 920 configuration file, iRite®, COD file, and firmware file
- Sanity checks for command errors
- Create STD database files

### Flash Drives:

- Supports USB 2.0
- Create sub directories by unit ID and database name
- Use the root directory for generic files

### Approvals:

- NTEP CC 99-091
- Measurement Canada AM-4847



920i Onboard Weigh Center



Single Assembly



Double Assembly

## APPROVALS



Measurement  
Canada  
Approved

# TradeRoute™ HL Series

Legal for Trade Onboard Weighing System

## Specifications: 920i® USB Indicator

### Power:

Line voltages: 115 or 230VAC, 9-36VDC,  
+/- 6, 25 Watt input  
Frequency: 50 or 60 Hz  
Power consumption: 340 mA, maximum at 115VAC  
(26W) 240 mA at 230VAC (26W)

### Excitation Voltage:

10 ± VDC, 16 x 350 Ω or 32 x 700 Ω load cells  
per A/D card

### Analog Signal Input Range:

-10 mV to +45 mV

### Analog Signal Sensitivity:

0.3 μV/graduation minimum at 7.5 Hz  
1.0 μV/graduation typical at 120 Hz  
4.0 μV/graduation typical at 960 Hz

### A/D Sample Rate:

7.5 to 960 Hz, software selectable

### Resolution:

Internal resolution: 8 million counts  
Weight display resolution: 9,999,999

### System Linearity:

± 0.01% full scale

### Digital I/O:

Six I/O channels on CPU board; optional 24-channel  
I/O expansion boards available

### Circuit Protection:

RFI, EMI, ESD protection

### Serial Ports:

Four ports on CPU board support up to  
115,200 bps; optional dual-channel serial expansion  
boards available

Port 1: Full duplex RS-232

Port 2: USB Type A and Type B connectors

Port 3: Full duplex RS-232, 20 mA output

Port 4: Full duplex RS-232, 2-wire RS-485,  
20 mA output

### Display (W x H):

4.6 in x 3.4 in (116 W x 86 mm H), 320 x 240 pixel  
VGA Liquid Crystal Display (LCD) module with  
adjustable contrast

### Keyboard:

27-key membrane panel, tactile feel

### Operating Temperature:

Legal: 14°F to 104°F (-10°C to 40°C)  
Industrial: 14°F to 122°F (-10°C to 50°C)

### Weight:

45 lb, weigh center

### Rating/Material:

NEMA 4X/IP66, stainless steel

### Warranty:

Two-year limited warranty

### Indicator Approvals:

NTEP CC 01-088, Class III/III 10,000d  
Measurement Canada AM-5426, Class III/III HD  
10,000d  
OIML UK 2658, 6,000/10,000  
CE marked  
UL & C-UL listed (Universal, Deep and Wall Mount  
Enclosure)

## Specifications: Epson® TM-U295 Printer

### Print Speed:

1.9 to 2.3 lines per second (5 x 7 character,  
3 dot line spacing)

### Column Capacity:

35/42 columns

### Characters Per Line:

35 standard font

### Print Area:

2.59 in W (65.8 mm W)

### Character Formation:

5 x 7 and 7 x 7 dot matrix

### Character Height:

0.11 standard font

### Print Head Life:

Approximately 100 million strokes/pin

### Form Thickness:

Single-ply - 0.003 in to 0.009 in  
(0.08 to 0.23 mm)  
Copy paper - 0.003 in to 0.014 in  
(0.08 to 0.36 mm)

### Ribbon:

Cassette-type purple ribbon. Ribbon life  
is approximately 1.5 million characters  
(continuous prints). Black ink also available.

### Approvals:

UL listed, CSA certified, CE marked

### Warranty:

One-year limited warranty  
(includes print head)

## Specifications: JB4SS Junction Box

### Cable Fittings:

#### P/N 88956:

(4) PG7 0.118-0.255 strain relief  
(2) PG11 0.197-0.394 strain relief  
(1) Prevent™ breather vent

#### P/N 107700:

(4) PG9 0.138-0.315 strain relief  
(2) PG11 0.197-0.394 strain relief  
(1) Prevent™ breather vent

### Enclosure:

Stainless Steel NEMA 4X

### Connectors:

Spring clamp screwless, 12-28 AWG

### Trimming:

Individual cell, signal trim, ranges zero trim  
12.49 k-100 k ohms with 2.49 k ohms isolation  
resistors

### Potentiometers:

100 k ohm, 25 turn cermet

### Circuit Board:

3.8 x 2.3 in. (96.5 x 58.4 mm), with conformal coating

### Warranty:

One-year limited warranty

## Specifications: RL2000B S-Beam Load Cell

### Full Scale Output:

3.0 mV/V

### Output Resistance:

350 ohms, +/- 3

### Input Resistance:

385 ohms, +/- 5

### Material/Finish:

High-alloy steel, nickel plated

### Temperature:

Compensated range  
14°F to 104°F (-10°C to 40°C)

### Seal Type:

Environmentally sealed, IP67

### Safe Overload:

150% Full scale

### Rated Excitation:

10V DC (15V maximum)

### Nonlinearity:

0.03% Full scale

### Hysteresis:

0.02% Full scale

### Insulation Resistance:

5000 megohms

### Cable Length:

20 ft/6.1 m

### Cable Diameter:

.200 polyurethane jacket

### Cable Color Code:

Red ..... + Excitation  
Black ..... - Excitation  
Green ..... + Signal  
White ..... - Signal

### Warranty:

Two-year limited warranty

### Approvals:

FM approved  
NTEP approved  
CE marked

# TradeRoute™ HL Series

Legal for Trade Onboard Weighing System

ONBOARD WEIGHING

## Part Number/Price

PART #	MODEL #	DESCRIPTION	PRICE
<b>Complete System</b>			
131098		15,000 lb x 5 lb/8,000 x 2 kg 3-point onboard system (Class III), qty 1 each OB5-SGL5, OB10-DBL5, 920i® weigh center	\$11,195.00
131099		20,000 lb x 5 lb/10,000 x 2 kg 4-point onboard system (Class III/IIIL), qty 2 OB10-DBL5, qty 1, 920i weigh center	13,330.00
131100		30,000 lb x 10 lb/15,000 x 5 kg 3-point onboard system (Class III), qty 1 each OB10-SGL10, OB20-DBL10, 920i weigh center	11,995.00
131101		40,000 lb x 10 lb/20,000 x 5 kg 4-point onboard system (Class III) qty 2 OB20-DBL10 qty 1, 920i weigh center	13,330.00
131102		20,000 x 5 kg 3-point onboard system (Class III) qty 1 each, OB15-SGL105, OB30-DBL15, 920i weigh center	13,995.00
131103		60,000 lb x 10 lb/30,000 x 5 kg 4-point onboard system (Class III/IIIL/IIHD) qty 2, OB30-DBL15, qty 1, 920i weigh center	14,995.00
<b>Weighing Module Assembly Kits (indicator package required)</b>			
154125		20,000 x 5 lb/10,000 x 2 kg 4-point onboard system (Class III/IIIL), qty 2, OB10-DBL5, JB4SS, 30 ft homerun cable, 60 ft conduit, power cable	9,250.00
154124		40,000 x 10 lb/20,000 x 5 kg 4-point onboard system (Class III/IIIL), qty 2, OB20-DBL10, JB4SS, 30 ft homerun cable, 60 ft conduit, power cable	9,250.00
154122		60,000 x 10 lb/30,000 x 5 kg 4-point onboard system (Class III/IIIL), qty 2, OB30-DBL15, JB4SS, 30 ft homerun cable, 60 ft conduit, power cable	10,945.00
<b>System Components</b>			
131442		Electronics package includes: indicator, Epson® Ticket Printer, 25 ft load cell cable, power cable, housing, vibration mounts for installation to customer supplied mounting bracket	3,990.00
154109		In-cab indicator 920i (requires 154112, 154111 and printer)	2,795.00
154112		In-cab LED alarm assembly, 8 ft cable	90.00
154111		Inclinometer, j-box assembly, 35 ft cable	550.00
65635		Epson TM-U295 printer	565.00
131811		Optional LED cab alarm, 35 ft	100.00
15494	EL146HE	4 conductor hostile environment load cell cable	1.55/ft
88956	JB4SS	JB4SS signal trim j-box with PG37 cord grips	235.00
128123		Conduit, 1/2 in non metallic liquid tight polytuf®	10.00/ft
128670	OB5-SGL5	Low profile 5 K single assembly	2,850.00
128666	OB10-DBL5	Low profile 10 K double assembly	3,600.00
127956	OB10-SGL10	Low profile 10 K single assembly	2,850.00
127958	OB20-DBL10	Low profile 20 K double assembly	3,600.00
127957	OB15-SGL15	Low profile 15 K single assembly	3,550.00
127959	OB30-DBL15	Low profile 30 K double assembly	4,995.00
155300	OB30-TAN15	Low profile 30 K tandem assembly	5,560.00
130107	Packaging	Double/Double packaging	95.00

Other capacities available via specials request, reference NTEP and Canadian Weights & Measurements CC number

Note: Hydraulic pump, connect to your existing hydraulic pump with a maximum pressure of 3,000 PSI with a minimum flow of 5 GPM for best performance of lifting speed

Note: In cab weigh center available upon specials request

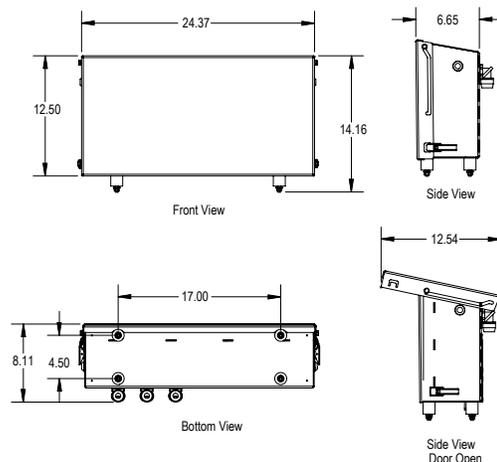

920i® weigh center dimensions

www.ricelake.com | Phone: 800-472-6703

RICE LAKE

# Loadrunner™ Onboard Weighing Systems

## Roll-Off Systems Kit

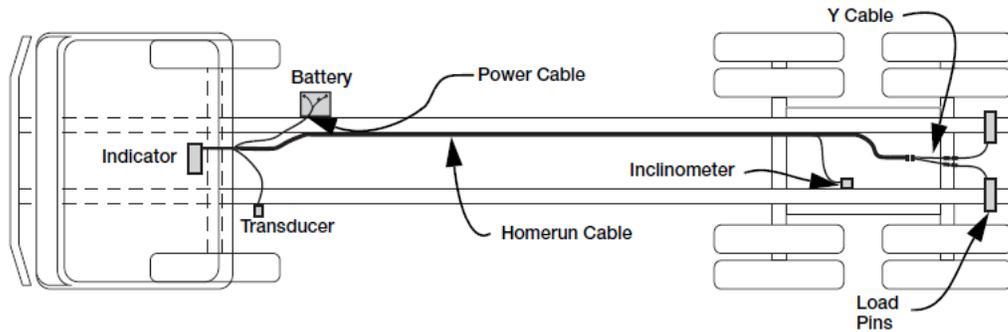

**OB-350 Indicator**  
PN 131219



**Hydraulic Transducer**  
PN 131211



**Roll-Off Load Pin**  
PN 131204



**Onboard Inclinometer**  
PN 131222



**Roll-Off Kit**  
PN 153104



**Power Cable**  
PN 131221

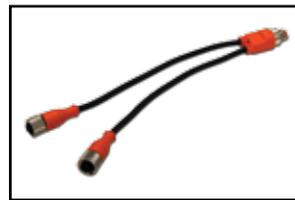

**Y-Splitter Cable**  
PN 131226



**Homerun Cable**  
PN 131228

Compatibility note: The Loadrunner Roll-Off System is sized to replace the hinge pivot of Roll-Off hoist models produced by Galbreath, GalFab, Accurate, Ruddco and other Roll-Off manufacturers.

### Part Number/Price

PART #	DESCRIPTION	PRICE
<b>System</b>		
158194	Roll-Off Truck System with 2.5 inch load pins, indicator, cables and hardware	\$3,350.00
<b>Replacement Spare Parts</b>		
131204	Roll-Off load pin, 20,000lbs at 1.3mV/V 350 ohm with male M12 Lumberg connector, 2.5in x 10.8in l	600.00
131211	Hydraulic transducer, RL300-h, 5000 psi, 32 ft stainless steel IP68 with male M12 connector	390.00
131219	OB-350 two channel indicator, RS232 CANbus interface (does not include power cable)	650.00
131221	Assembly fuse cable, in-line power cable with fuse for OB350 indicator	28.00
131222	Onboard inclinometer, 35ft CANbus cable inclinometer junction box for OB350 indicator	350.00
131226	Y-splitter cable, M12 four way connectors, for use on two way junction box	60.00
131228	Assembly 15ft cable, homerun cable with M12 five way CANbus F/M connectors	65.00
131800	Assembly 6ft cable, homerun cable with M12 male/female connectors	40.00
153104	Roll-Off assembly kit	95.00
158196	Onboard hydraulic bracket, angle bracket kit used for inclinometer	26.00
153098	Roll-Off Collar, 0.40 x 2.625	25.00
153116	Top nut lock, 1/2-20NF, grade 9 yellow zinc	3.00
153117	Cap screw, 1/2-20NF x 5, hex head grade 8, steel zinc plated	7.50

# Loadrunner™ Onboard Weighing Systems

## Dump Truck Systems Kit

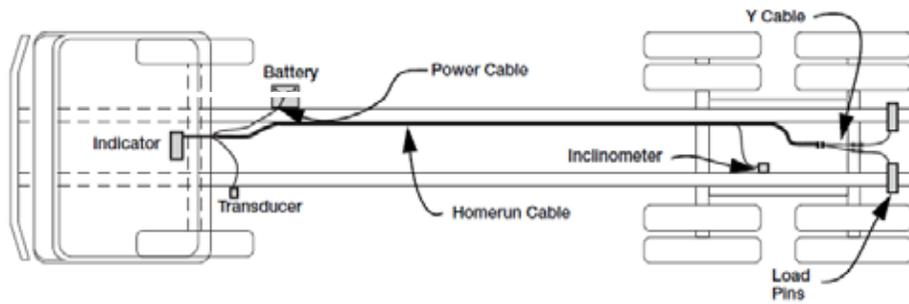

**OB-350 Indicator**  
PN 131219



**Hydraulic Transducer**  
PN 131211



**Dump Truck Load Pin**  
PN 131207



**Onboard Inclinometer**  
PN 131222

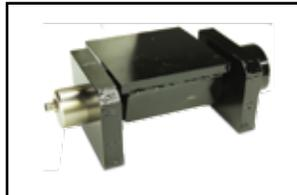

**Dump Truck Hardware Kit**



**Power Cable**  
PN 131221



**Y-Splitter Cable**  
PN 131226



**Homerun Cable**  
PN 131228

*Compatibility note: The Loadrunner dump truck kit has been designed for use on dual pin hinge pivot type dump bodies only. For dump truck body rear pivot assemblies using a single hinge bar, contact Rice Lake.*

### Part Number/Price

PART #	DESCRIPTION	PRICE
<b>System</b>		
158195	Dump Truck System with 2.0 inch load pins, indicator, cables and hardware	\$3,600.00
<b>Replacement Spare Parts</b>		
154189	Onboard weighing Dump Truck hardware kit for right rear (load pin not included)	175.00
159840	Onboard weighing Dump Truck hardware kit for left rear (load pin not included)	175.00
131207	Dump Truck load pin, 20,000lbs at 1.3mV/V 350 ohm with male M12 Lumberg connector, 2.0in x 11.8in l	590.00
131211	Hydraulic transducer, RL300-h, 5000 psi, 32 ft stainless steel IP68 with male M12 connector	390.00
131219	OB-350 two channel indicator, RS232 CANbus interface (does not include power cable)	650.00
131221	Assembly fuse cable, in-line power cable with fuse for OB350 indicator	28.00
131222	Onboard inclinometer, 35ft CANbus cable inclinometer junction box for OB350 indicator	350.00
131226	Y-splitter cable, M12 four way connectors, for use on two way junction box	60.00
131228	Assembly 15ft cable, homerun cable with M12 five way CANbus F/M connectors	65.00
131800	Assembly 6ft cable, homerun cable with M12 male/female connectors	40.00
158196	Onboard hydraulic bracket, angle bracket kit used for inclinometer	26.00
116559	Screw cap hex head, 1/2-20NFX3-1/2, grade 8 steel yellow zinc plated	3.00
119963	Ring, .25in x 2.25in x 3in	3.00
119966	Support, 1in x 4in x 5.16in with 2.02in hole	13.85
119973	Load cell mount weldment	42.50
119974	Glass tubing, 2.233 OD x 2.015 ID x 6.5 long	37.50
153116	Top lock nut, 1/2-20NF grade 9 yellow zinc	3.00
15173	Plain washer, 1/2 type B series N steel zinc plate	1.10
159839	Support ring weldment, left rear	35.00
119969	Support ring weldment, right rear	35.00
162356	Installation manual	N/C

# Pipe Lever

Table of Contents

Pipe Lever Scale ..... 658

**ESPAÑOL** | Visit [ricelake.com/spanish](http://ricelake.com/spanish)  
to see all RLWS materials  
available in Spanish

Product names, logos, brands, and other trademarks featured or referred to within this publication are the property of their respective trademark holders.

# Pipe Lever Scale

## Standard Features

- Capacity range: 5,000 to 60,000 lb
- NTEP and Canadian type-approved models available
- RL20000 alloy steel load cell standard (prices includes load cell and ITCM load cell assembly)
- Mild steel construction, black paint finish
- Stainless steel, hermetically-sealed load cells available
- Custom built

## Specifications

### End Load Capacity:

100% full scale

### mV/V Output:

1.50 - 1.87 mV/V nominal

### Cable Length:

20 ft (6.1 m)

### Warranty:

One-year limited warranty

### Approvals:

NTEP CC 94-126 Model PLS-XXYY-ZZK Class III/IIIL, 5000  
Measurement Canada Approved, AM-5114, Legal For Trade on sizes greater than 1.6m, or a capacity greater than 10,000 kg



*Custom sizes fit your tank/hopper system for fewer modifications and less installation time.*

## APPROVALS



Measurement  
Canada  
Approved





# Pipe Lever Scale

Please complete and fax this form to RLWS for pricing. Fax: (715) 234-6967

## STANDARD AND MINIMUM LEVER LENGTH SPECIFICATIONS.

	10K TOTAL LOAD*		25K TOTAL LOAD*		30K TOTAL LOAD*		40/50K TOTAL LOAD*	
	Standard	Minimum	Standard	Minimum	Standard	Minimum	Standard	Minimum
<b>A</b>	-	48.00in	-	48.00in	-	60.00in	-	60.00in
<b>B</b>	-	48.00in	-	48.00in	-	60.00in	-	60.00in
<b>C</b>	12.25in	4.50in	15.50in	7.00in	15.62in	7.00in	18.00in	7.00in
<b>D</b>	6.00in	6.00in	9.50in	8.75in	9.50in	8.75in	13.00in	12.00in
<b>E</b>	6.00in	6.00in	9.50in	8.75in	9.50in	8.75in	13.00in	12.00in
<b>F</b>	8.62in	8.62in	13.56in	13.56in	13.81in	13.81in	18.18in	18.18in
<b>G</b>	4.50in	3.50in	6.50in	4.75in	6.50in	4.75in	9.25in	6.50in
<b>H</b>	4.50in	3.50in	6.50in	4.75in	6.50in	4.75in	9.25in	6.50in
<b>J</b>	24.00in	24.00in	32.25in	32.25in	32.25in	32.25in	37.25in	37.25in

A x B must be equal to or less than 64 square feet, or consult factory.    A x B must be equal to or less than 100 square feet, or consult factory.    A x B must be equal to or less than 100 square feet, or consult factory.    A x B must be equal to or less than 100 square feet, or consult factory.

\* Live and dead load

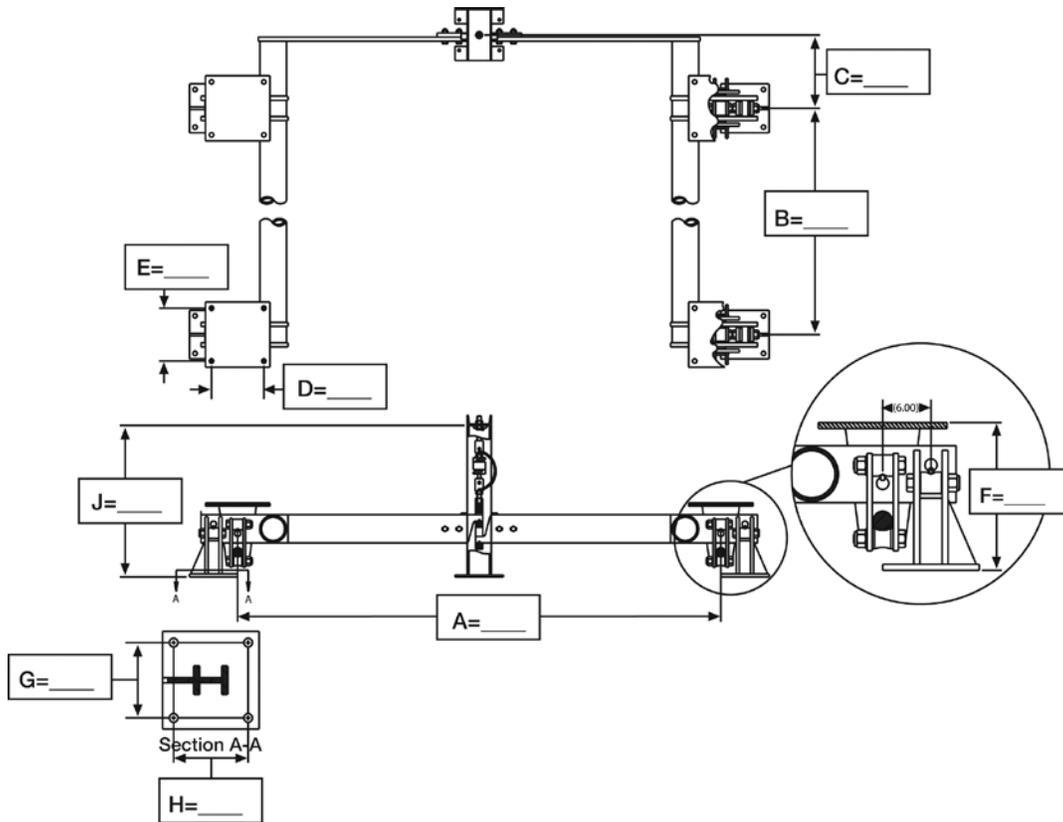

<b>A</b>	
<b>B</b>	
<b>C</b>	
<b>D+</b>	
<b>E+</b>	
<b>F</b>	
<b>G**</b>	
<b>H**</b>	
<b>J</b>	

+ Chair hole dimensions    \*\* Stand hole dimensions

- 5K Total Load\*\*\*
- 10K Total Load\*\*\*
- 25K Total Load\*\*\*
- 30K Total Load\*\*\*
- 40K Total Load\*\*\*
- 50K Total Load\*\*\*

- Stainless steel hermetically-sealed load cell (specify model number)
- Mild steel load cell (specify model number)

\*\*\* Live and dead load

These drawings are not to be used as installation guidelines

**Material Type:** \_\_\_\_\_

**Finish:** \_\_\_\_\_

**NTEP:**     Yes     No

**NTEP Legal for Trade:**     Yes     No



# Portable Vehicle Scales

## Table of Contents

Intercomp PT300™ Wheel Load Scale	662
Intercomp PT300™ RFX/PT300DW™ RFX Solar Powered Wheel Load Scale	663

**ESPAÑOL** | Visit [ricelake.com/spanish](http://ricelake.com/spanish)  
to see all RLWS materials  
available in Spanish

Product names, logos, brands, and other trademarks featured  
or referred to within this publication are the property of their respective trademark holders.

# Intercomp PT300™

Wheel Load Scale

## Standard Features

- Self contained digital indicator on each scale
- 1 in Liquid Crystal Display (LCD) with auto backlight
- 150 hours of continuous use with 4 size "AA" Nicad batteries
- lb/kg selectable
- Transmits weight to another scale for totalizing individual axles (requires optional Interconnect cables)
- Configurable RS-232, RS-485 or 20mA passive current loop to interface with a printer or remote display

## Specifications

### Humidity:

10 to 95% non-condensing

### Temperature:

Operating: -20°F to 150°F (-28°C to 65°C)  
Storage: -40°F to 170°F (-40°C to 75°C)

### EMI/RFI:

Meets Mil Spec 461

### Voltage:

Self-contained 4-size AA nickel cadmium batteries (batteries included)  
Integral universal charger 10-15 VDC

### Controls:

All controls are located on a waterproof membrane keypad with large contact surfaces

Print/Accumulate, ON/OFF, Zero, Local/Total

### Display Annunciators:

Local Weight, Total Weight, Accumulated Total Weight, Low Battery, lb/kg

### Speed:

4 display updates per second

### Accuracy:

± 1% of reading or  
± display graduation whichever is greater

### Units Of Measure:

lbs, kg selectable

### Safe Overload:

150% of capacity

### Overall Size (W x D x H):

PT300: 16 x 20 x 3 in (406 x 508 x 76 mm)  
PT300DW: 26 in x 20 in x 3 in (660 x 508 x 76 mm)

### Platform Size:

PT300: 12 in x 12 in (305 mm x 305 mm)  
PT300DW: 22 in x 14 in (559 mm x 356 mm)

### Weight:

PT300: 37 lb (16.8 kg)  
PT300DW: 49 lb (22 kg)

### Case:

Heat-treated aluminum

### Warranty:

One-year limited warranty

### Approvals:

NTEP Certified (PT300-50 only) Class IV CC 90-106P



PT300

## APPROVALS



## Part Number/Price

PART #	MODEL	PLATFORM SIZE	CAPACITY/GRADUATION	EST. SHIP WEIGHT	PRICE
43738†*	PT300	12 in x 12 in	20,000 lb x 50 lb	40 lb	\$1,595.00

\* NTEP Certified Class IV

† Battery charging cable and transformer is included with orders for 2, 4, or 6 scales. Interconnect cable is optional and shown below. See options for pricing on single scale charging cable and transformers.

## Options/Accessories

PART #	DESCRIPTION	PRICE
43951	115/230 VAC battery charger (1 scale)	\$160.00
43952	115/230 VAC interconnect/charging cable (2 scales) (Totalizes and charges scales together)	330.00
43953	115/230 VAC interconnect/charging cable (4 scales) (Totalizes and charges scales together)	500.00
43954	115/230 VAC interconnect/charging cable (6 scales) (Totalizes and charges scales together)	670.00

# Intercomp PT300™ RFX/PT300DW™ RFX Solar Powered Wheel Load Scale

## Standard Features

- Equipped with radio module to talk to optional RFX indicator
- Self contained digital indicator on each scale
- 1 in Liquid Crystal Display (LCD) with auto backlight
- Dual power provided by solar and 4 "AA" NiMH batteries
- Configurable RS-232, RS-485 or 20mA passive current loop to interface with a printer or remote display

### Optional RFX Wireless Hand Held Indicator:

- Rugged ABS industrial housing
- Four-line, 5-digit, 0.5in LCD digital readout
- Indicator carrying case with charger and 4 "AA" NiMH rechargeable batteries
- 40 hours of continuous use (with backlight off)
- Works with up to 6 scales at once. 200ft indoors, 300ft line of sight
- RS232/USB output
- Allows user to view individual scale/pad weights, total weight of all scales, center of balance and ability to store and recall up to ten arm records

## Specifications

### Humidity:

10 to 95% non-condensing

### Temperature:

Operating: -20°F to 150°F (-28°C to 65°C)  
Storage: -40°F to 170°F (-40°C to 75°C)

### EMI/RFI:

Meets Mil Spec 461

### Battery Life:

With radio off: 250 hours plus solar boost  
With radio on: 200 hours plus solar boost  
Battery life with daytime outdoor use, the solar boost allows the scale to last a full year without requiring direct power charging

### Power Source:

Dual power of solar and batteries. With use of direct power cable 5-15VDC, 100-240VAC

### Controls:

All controls are located on a waterproof membrane keypad with large contact surfaces  
Print/Accumulate, ON/OFF, Zero, Local/Total

### Display Annunciators:

Local Weight, Total Weight, Accumulated Total Weight, Low Battery, lb/kg

### Speed:

4 display updates per second

### Accuracy:

± 1% of reading or ± display graduation whichever is greater

### Units Of Measure:

lbs, kg selectable

### Safe Overload:

150% of capacity

### Overall Size (W x D x H):

PT300: 16 x 20 x 3 in (406 x 508 x 76 mm)  
PT300DW: 26 x 20 x 3 in (660 x 508 x 76 mm)

### Platform Size:

PT300: 12 in x 12 in (305 mm x 305 mm)  
PT300DW: 22 in x 14 in (559 mm x 356 mm)

### Weight:

PT300: 37 lb (16.8 kg)  
PT300DW: 49 lb (22 kg)

### Case Material:

Heat treated aluminum

### Warranty:

One-year limited warranty



PT300 Wireless



Optional



# Intercomp PT300™ RFX / PT300DW™ RFX Solar Power

Wheel Load Scale

PORTABLE VEHICLE SCALES

## Part Number/Price

PART #	MODEL	SIZE	GRADUATION	WEIGHT	PRICE
<b>PT300, battery operated</b>					
165278*	PT300-RFX	12 in x 12 in	5,000 lb x 5 lb (2,500 x 5 kg)	40 lb	\$1,545.00
165279*	PT300-RFX	12 in x 12 in	10,000 lb x 5 lb (5,000 x 2 kg)	40 lb	1,745.00
165280*	PT300-RFX	12 in x 12 in	20,000 lb x 20 lb (10,000 x 10 kg)	40 lb	1,595.00
169017*	PT300-RFX, NTEP approved	12 in x 12 in	20,000 lb x 50 lb (10,000 x 25 kg)	40 lb	1,595.00
<b>PT300 DW, solar powered</b>					
165262*	PT300DW-RFX	22 in x 14 in	5,000 lb x 5 lb (2,500 x 2 kg)	60 lb	2,095.00
165263*	PT300DW-RFX	22 in x 14 in	10,000 lb x 5 lb (5,000 x 2 kg)	60 lb	2,245.00
165264*	PT300DW-RFX	22 in x 14 in	20,000 lb x 20 lb (10,000 x 10 kg)	60 lb	2,095.00
165265*	PT300DW-RFX	22 in x 14 in	30,000 lb x 50 lb (14,000 x 20 kg)	75 lb	3,095.00
165266*	PT300DW-RFX	22 in x 14 in	40,000 lb x 100 lb (18,000 x 50 kg)	75 lb	3,595.00

\*Direct power cable is not included with orders for 2,4, or 6 scales. Power cable and/or RFX Wireless Indicator are optional and shown below.

## Options/Accessories

PART #	DESCRIPTION	PRICE
119007	RFX Wireless Hand Held Indicator	\$995.00
163184	100/240 VAC Direct power cord (2 scales) provides direct power to scales	254.00
163185	100/240 VAC Direct power cord (4 scales) provides direct power to scales	424.00
163186	100/240 VAC Direct power cord (6 scales) provides direct power to scales	594.00

www.ricelake.com | Phone: 800-472-6703

**RICE LAKE**

# Power Conditioning

## Table of Contents

<b>Transient Protection AC, DC, Series and Parallel</b> .....	<b>668</b>
<b>TP232 RS-232</b> .....	<b>669</b>
<b>Tripp-Lite DNET1</b> .....	<b>670</b>
<b>LCP-1 DC</b> .....	<b>671</b>
Transient Protection	
<b>UJB3T6 DC</b> .....	<b>672</b>
Transient Protection	
<b>TP75 DC</b> .....	<b>673</b>
Transient Protection	
<b>ISOBLOK®</b> .....	<b>674</b>
AC Transient Protector	
<b>ISOBAR®</b> .....	<b>675</b>
AC Transient Protector	
<b>EL226</b> .....	<b>676</b>
AC Transient Protector	
<b>EL225-4</b> .....	<b>677</b>
<b>Sola MCR Series</b> .....	<b>678</b>
<b>Tripp-Lite PV Series</b> .....	<b>679</b>
<b>LC1200</b> .....	<b>680</b>
<b>Sola S1K/S3K</b> .....	<b>681</b>
Uninterruptible Power System	
<b>Liebert PSP/PSA</b> .....	<b>682</b>
Uninterruptible Power Supply	
<b>Eaton 3S/5S</b> .....	<b>683</b>
Uninterruptible Power Supply	

**ESPAÑOL** | Visit [ricelake.com/spanish](http://ricelake.com/spanish)  
to see all RLWS materials  
available in Spanish

Product names, logos, brands, and other trademarks featured  
or referred to within this publication are the property of their respective trademark holders.

## Selecting the Best Power Conditioning Devices/Equipment for Your Applications

Digital weighing indicators utilize an incredibly small signal in their operation. These signals are easily disturbed by any number of voltage distortions. Additionally, many weighing systems are now designed with a complex array of peripheral equipment, including printers and computers. To maintain proper operation and provide maximum protection, Rice Lake Weighing Systems offers this wide variety of power conditioning products as your first line of defense in the battle to improve power problems.

The following is a list of power problems you are likely to experience, with a reference to the equipment we recommend to solve that particular problem. A “quick reference” Power Conditioning equipment chart found on page 666 is also included for easy reference.

### Voltage Surge

A voltage surge is a temporary rise in voltage level lasting at least one AC cycle (1/60 second). Typically caused by switching off high-power electric motors (electric welders, compressors, machine tools, conveyors, material handling equipment and power tools), momentarily boosting the line voltage. Regulation of the line to an acceptable voltage level is required to prevent the damage caused by voltage surges. The SOLA MCR series of voltage regulators, MCR070, MCR150 and MCR250, are designed to keep the voltage level within acceptable and harmless limits.

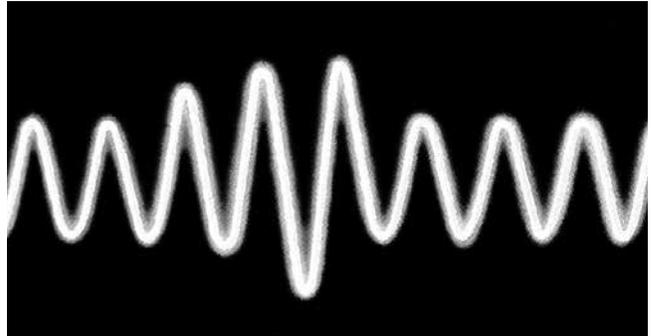

### Voltage Dip

A voltage dip is the opposite of a voltage surge, lasting at least one AC cycle (1/60 second). Typically caused by a sudden nearby increase in an electrical load, such as turning on high-power electrical motors (electric welders, compressors, machine tools, conveyors, material handling equipment and power tools). During this time, every other piece of operating equipment is forced to operate with the reduced available voltage. Regulation of the line voltage is required to remedy this situation. The SOLA MCR series of voltage regulators, MCR070, MCR150 and MCR250, solve your problem by temporarily boosting the line voltage to within acceptable limits, until the voltage dip condition has corrected itself.

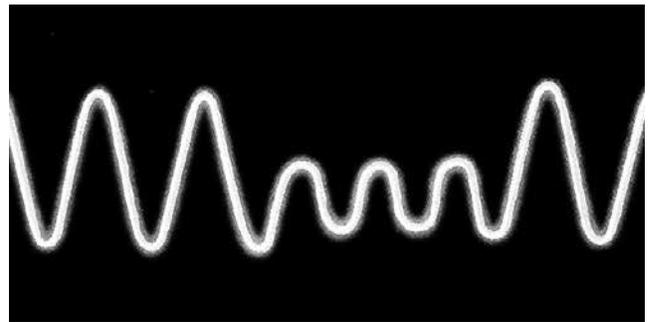

### Voltage Spikes

A voltage spike is a large, damaging voltage pulse caused when lightning strikes a powerline, a communications line, a signal or sensing line, or even the nearby ground. Voltage spikes last only a few milliseconds, but can reach a potential of 1,000 volts. High-quality protection is the only practical answer. For your load cells, RS-232 or 20 mA communication lines and other DC protection needs, our UJB3T6, LCP-1 and TP-75 are practical solutions. For line-powered equipment, the Tripp-Lite ISOBLOK® and ISOBAR® or the Rice Lake Weighing Systems EL225 or EL226 are the most effective protection against voltage spikes.

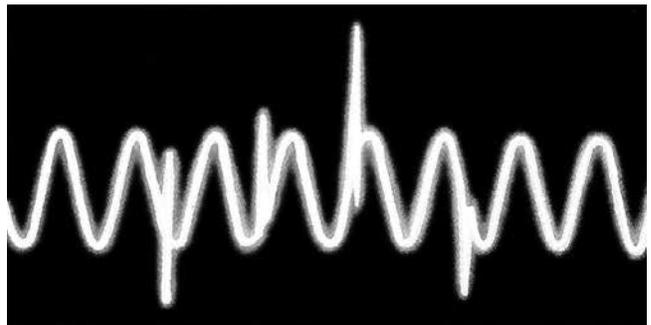



### Brownouts

Brownouts are prolonged voltage dips of as much as 15 percent, lasting from several hours to several days. This condition is initiated by local power companies during hours of unusually high demands. Brownouts create many forms of abnormal behavior. The only way to safeguard the operation of critical equipment is to bring the powerline voltage back up to normal specifications. The SOLA MCR series of line voltage regulators, MCR070, MCR150 and MCR250; or the Sola SK Series, the Liebert or Eaton Uninterruptible Power Systems can eliminate the problems associated with brownout conditions.

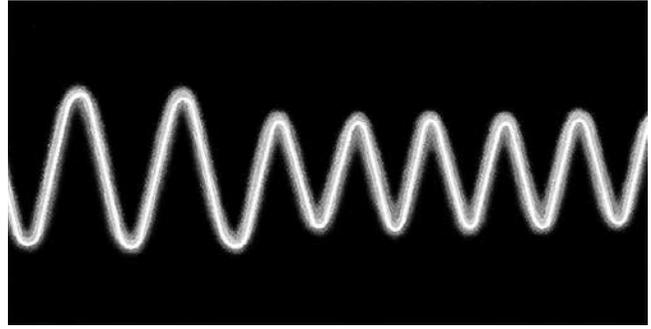

### Blackouts

The ultimate power problem! The only way to keep critical electrical equipment running during a blackout is to provide a new supply of power, either from batteries or mechanical generators. Liebert PSA Uninterruptible Power System is our answer to battery-supplied electrical power.

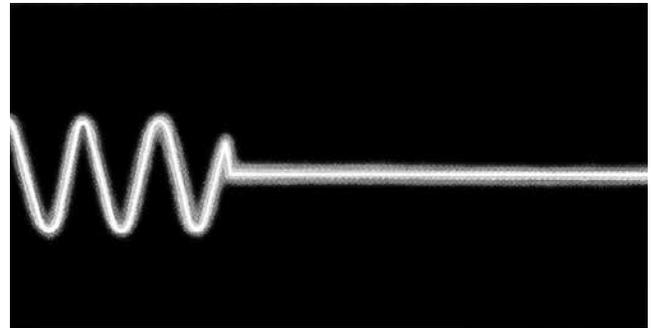

### Electrical Noise

Noise is a disturbance of electrical power caused by distant lightning, radio transmitters, welding equipment, electrical switching equipment and poor brush contact on motors and other electronic devices utilizing switching power supplies. One solution is to prevent noise from entering the equipment by filtering the powerline input. The Tripp-Lite ISOBLOK® and ISOBAR®, or the Rice Lake Weighing Systems EL225 or EL226 will effectively filter most electrical noise problems. In severe cases, the use of uninterruptible power systems such as Liebert PSA and Sola S1K Series are recommended.

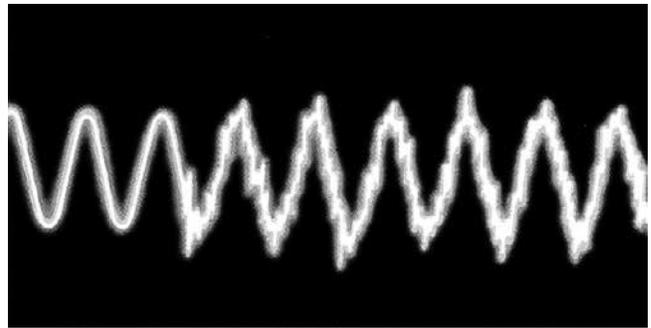

### Dropouts

A dropout is a temporary loss of electrical power normally caused by utility and maintenance switching functions where break-before-make switching strategies are used. This simply means that the old source of power is disconnected momentarily prior to the connection of the new power source. Your local utility company may be the most common source of this type of disturbance, causing many problems—notably computer lockups, software errors, equipment resets and diagnostic self-tests. The SOLA MCR series of regulators; MCR070, MCR150 and the MCR250 are available to deal with short-term dropouts (less than 3 milliseconds). For longer-lasting protection, Liebert PSA and Sola SK Series Uninterruptible Power Systems are recommended.

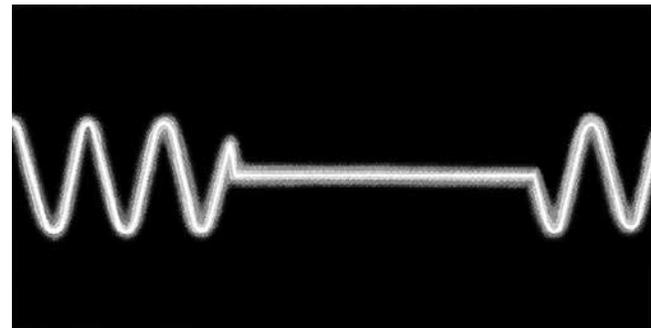

## Transient Protection AC, DC, Series and Parallel

### AC Protection

Designed for filtering voltage spikes and electrical noise from AC wall receptacles providing power to sensitive microprocessor-based equipment such as computers, printers and indicators. Clamping voltages typically are set to 140 volts AC rms and peak current handling capacities are near 6000 amperes.

### DC Protection

Designed for filtering voltage spikes and electrical noise from load cell cables, and both RS-232 and 20 mA serial communication lines protecting indicators, communications interfaces and computers.

### Parallel Protection

Protection is provided by “diverting” or “bypass” elements that attempt to quickly change the direction of the voltage spike, typically toward earth ground. Examples of “diverting” type elements are gas tubes, MOVs and Transzorbs™. In a parallel-type of transient protector, the equipment to be protected is not removed from the line in the event of a protector damaging voltage spike, leaving the possibility of a second catastrophic voltage spike to enter the unprotected equipment.

### Series Protection

Protection is provided by “blocking” type elements that buffer the equipment to be protected from the line voltage available at the wall receptacle. Examples of “blocking” type protective elements that are used in series-type transient protectors are fuses, circuit breakers, common mode coils and inductors. In addition, series-type protectors will also utilize “diverting” elements used in parallel protectors. In the series type of transient protector, the equipment to be protected is generally removed from the line source in the event of a damaging transient or surge. Rice Lake Weighing Systems endorses only series type AC and DC transient protectors. The additional performance and protection provided by them are substantial compared to parallel type counterparts.

### A Word About Grounds...

A good ground is essential for any successful transient protection scheme. However, simply driving a copper ground rod is not enough. The conductivity of the soil can vary seasonally, particularly if the local water table rises and falls with the season. An adequate ground in spring, when the water table is high, may not be adequate in late summer when the water table is low (and thunderstorms are common!). Check the resistivity of your ground regularly throughout the year. If problems appear, check with your local utility about alternate grounding techniques.

Type of Disturbance	AC Line Disturbance Solutions		
	TRANSIENT PROTECTORS	VOLTAGE REGULATORS	UNINTERRUPTIBLE POWER SYSTEMS
	ISOBLOK/ISOBAR Our Best - EL225, EL226	MCR Series	Sola Series
SURGE	*	✓	✓
DIP		✓	✓
BROWNOUT		✓	✓
DROPOUT		✓	✓
BLACKOUT			✓
SPIKES	✓		✓
NOISE EMI/RFI	✓		✓

\* Will provide some protection against surges; however, we recommend that transient protectors be used on lines where spikes, noise and interference occur.

### Our Policy

Rice Lake Weighing Systems recommends the installation of AC and/or DC transient protection, which is effective in significantly reducing both the frequency and degree of damage caused by AC and/or DC transient voltage occurrences. However, transient protection devices will not eliminate all damage caused by transient voltage. Rice Lake Weighing Systems does not warrant or guarantee any transient protection device against damage or repair or any scale-related or other electrical/electronic device, which is intended to be protected by any transient protection device. No other warranty or guarantees—express or implied—contrary to this written policy are supported or acknowledged by Rice Lake Weighing Systems.

# TP232 RS-232

## Standard Features

- Two metal mounting brackets
- Three stages of protection: gas discharge tube, series resistor, and Transient Voltage Suppressor (TVS)
- Two terminal posts for ground
- RS-232 high energy surge protector
- Terminal blocks for transmit, receive, request to send, clear to send and signal ground
- Safe for use with Computers and PLC's

## Specifications

### Clamping Voltage (Stage One):

72VDC minimum, 108VDC maximum

### Series Resistance (Stage Two):

2.7 Ohms

### Clamping Voltage (Stage Three):

14.3V minimum, 15.7 maximum

### Clamping Time:

Less than 5 x 10<sup>-9</sup> seconds

### Connectors:

5 position terminal blocks

### Dimensions:

Approximately 4.5 L x 3.3 W x 1.8 in H (114.3 L x 83.8 W x 45.7 mm H)

### Weight:

Approximately 0.42 lb (0.19 kg)

### Approvals:

CE marked

### Warranty:

One-year limited



720i Indicator



SURVIVOR®

LaserLight® Series Remote Display

## APPROVALS



## Part number/Price

PART #	DESCRIPTION	EST. SHIP WEIGHT	PRICE
69201	RS-232 transient serial protection TP232 high energy surge protector	1.0 lb	\$175.00

## Options/Accessories

PART #	DESCRIPTION	PRICE
17778	12 in ground strap, copper braid	\$10.25
17781	24 in ground strap, copper braid	13.25
69516	Additional installation manual	6.00

# Tripp-Lite DNET1

## Standard Features

- RJ45 input and output connections
- 5 in Ethernet patch cable enables ideal protection placed as close as possible to the point of use
- 6 in heavy gauge lead connects to designated grounding lugs on protected equipment
- Surge suppression utilizing high speed avalanche diodes divert excess energies on the network to ground

## Specifications

### Interface Type:

RJ45

### Application:

100 Base-T, 10 Base-T, Token Ring, AS400/Sys3x, RS-422. Ideal for NICs, terminals, hubs, MAUs, LAN equipment. RJ11/45-compatible. RJ45 cable included

### Lines Protected:

1-8

### Peak Pulse Clamping Voltage:

7.5V

### Maximum Current:

750 Amps

### Shunt Capacitance:

<40  $\mu$ F

### Warranty:

One-year limited



## Part Number/Price

PART #	DESCRIPTION	EST. SHIP WEIGHT	PRICE
72682	DNET1 network surge suppressor	1 lb	\$40.00

# LCP-1 DC

Transient Protection

## Standard Features

- Low cost, non-serviceable
- Effective series protection for strain gauge transducers
- Encapsulated circuitry ensures positive protection against fungus or corrosion on boards
- Two nylon strain reliefs for 0.187 in-0.312 in (4.7 mm-7.9 mm) diameter cable

## Specifications

### Protection Type:

Four-channel series type with separate shield

### Maximum Excitation Voltage:

18VDC or 18VAC

### Clamping Voltage:

75VDC or 75VAC

### Clamping Time:

<100 nanoseconds typical

### Peak Surge Currents:

5,000 Amps any line to ground and 5,000 Amps excitation to excitation

### Maximum Serial Transmission Rate:

30 Kbaud

### Grounding:

Through a .25 in (6.35 mm) lug to a 20 ft (6.1 m) insulated #10 AWG ground wire provided

### Cable Fitting:

(2) Standard nylon strain relief for 0.187 in-0.312 in (4.7 mm-7.9 mm) diameter cable

### Enclosure:

Chemically-resistant PVC. This device, for outdoor or indoor service, is not intended for washdown service (NEMA 4) or for submersion (NEMA 6). Optional NEMA 4X available

### Operating Temperature:

14°F to 104°F (-10°C to 40°C) consistent with NTEP guidelines

### Leakage:

7,500 MΩ minimum

### Dimensions:

4.0 W x 4.0 H x 2.50 in D (103.2 W x 103.2 H x 63.5 mm D)

### Warranty:

One-year limited

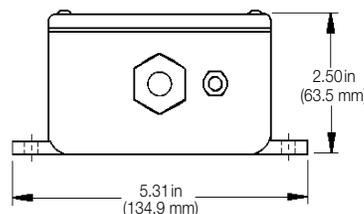
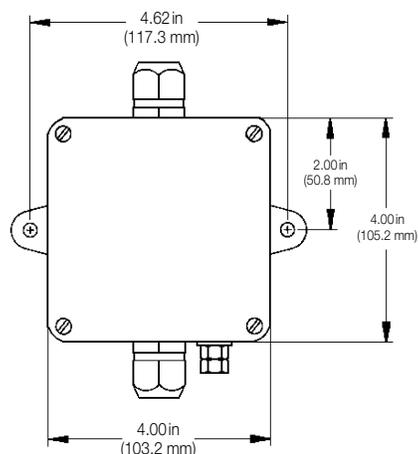
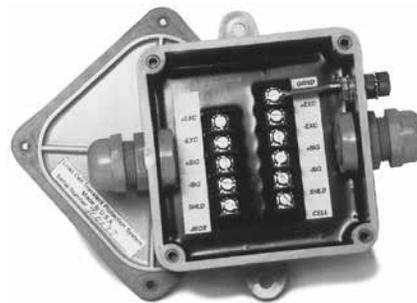

## Part Number/Price

PART #	DESCRIPTION	EST. SHIP WEIGHT	PRICE
21143	LCP-1 DC with cable compression fittings	2 lb	\$210.00

# UJB3T6 DC

Transient Protection

## Standard Features

- Factory serviceable
- Full six-wire with shield protection
- #6 SEMS screw type; accepts spade lugs, tinned leads or bare wires up to #12 AWG
- Up to eight parallel or summed load cells
- 50 K baud maximum transmission frequency
- Up to six serial data lines can be protected instead of load cells

## Specifications

### Protection Type:

Six-channel series type with separate shield

### Maximum Excitation Voltage:

20VDC or 20VAC

### Clamping Voltage:

75VDC or 75VAC

### Clamping Time:

75VDC Stages <100 nanoseconds typical

### Peak Surge Currents:

75VDC Stage - 5,000 Amps

### Maximum Serial Transmission Rate:

50 Kbaud

### Series Resistance:

0.219 ohms typical..

### Series Inductance:

110 µh typical

### Grounding:

20 ft (6.1 m) insulated #10 AWG wire

### Cable Fitting:

(2) nylon strain relief for 0.079in-0.236 in (2.0-6.0 mm) diameter cable

### Enclosure:

Fiberglass-Reinforced Polyester (FRP) NEMA 4X, maximum 40 psi washdown

### Operating Temperature:

14°F to 104°F (-10°C to 40°C)

### Circuit Board:

6.75 in x 4.75 in (171.5 mm x 120.7 mm) with anti-fungal coating

### Dimensions:

7.63 W x 6.63 H x 3.25 in D (193.8 W x 168.3 H x 82.6 mm D)

### Warranty:

One-year limited

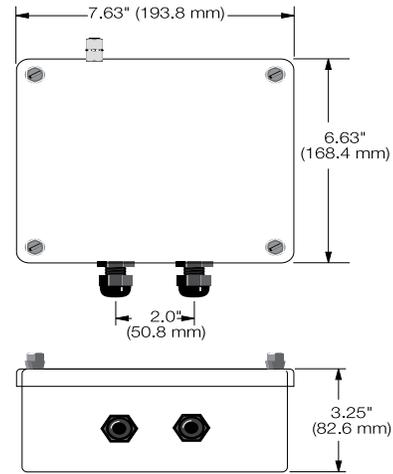

## Part Number/Price

PART #	DESCRIPTION	EST. SHIP WEIGHT	PRICE
21134	UJB3T6 DC	4 lb	\$350.00

## Options/Accessories

PART #	DESCRIPTION	PRICE
21135	UJB3T6 DC 6-channel load cell transient protector, board only	\$250.00

# TP75 DC

Transient Protection

## Standard Features

- Avalanche diode design
- Full 6-wire with shield protection
- NEMA 4X enclosure
- Unlimited number of parallel load cells; up to eight in series
- Terminal lugs provided

## Specifications

**Protection Type:**

Six-channel parallel type with separate shield

**Maximum Excitation Voltage:**

22.8VDC

**Response Time:**

Five nanoseconds

**Peak Surge Currents:**

100 Amps

**Series Resistance:**

0.0 ohms

**Series Inductance:**

0.0 μh

**Grounding:**

10 AWG wire or larger (not provided)

**Cable Fitting:**

(2) nylon strain relief for 0.187 in - 0.312 in (4.7 mm - 7.9 mm) diameter cable

**Enclosure:**

Impact-resistant polycarbonate NEMA 4X, maximum 40 psi washdown

**Operating Temperature:**

4°F to 121°F (-20°C to 85°C)

**Circuit Board:**

2.22 in x 2.22 in (56.4 mm x 56.4 mm)

**Dimensions:**

4.38 W x 3.15 H x 3.38 in D (111.1 W x 80 H x 85.9 mm D)

**Warranty:**

One-year limited

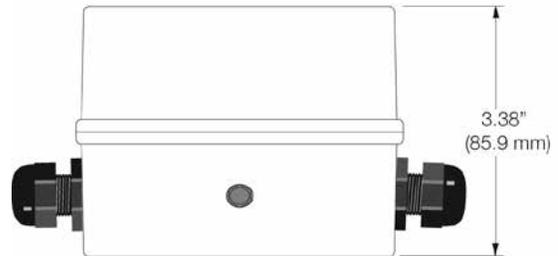
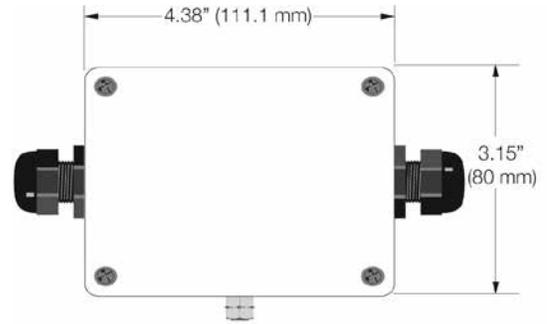
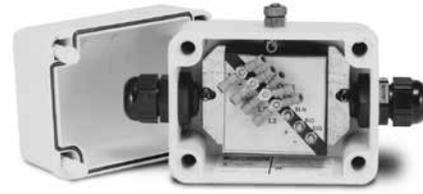

## Part Number/Price

PART #	DESCRIPTION	EST. SHIP WEIGHT	PRICE
33185	TP75, load cell protector and mounting hardware	2 lb	\$225.00

## Options/Accessories

PART #	DESCRIPTION	PRICE
31164	TP75 DC transient protection, board only, with labels	\$170.00

**ISOBLOK®**

AC Transient Protector

**Standard Features**

- Two outlets, direct plug-in
- LED indicator for power on
- LED indicator for protection circuitry
- UL1449 listed at 330 volts
- Mounting clamp assures positive connection

**Specifications****Clamp Voltage:**

140V rms

**Peak Surge Current:**

6,500 Amps

**Clamping Time:**

&lt;5 nanoseconds

**Input Voltage:**

120VAC

**Maximum Current:**

15 Amps

**Maximum Power:**

1875 Watts

**Noise Suppression:**

Frequency Attenuation  
 50 KHz>20 db  
 150 KHz>40 db  
 1 MHz>80 db  
 >6 MHz>30 db

**Dimensions:**

2.37 W x 4.15 H x 2.31 in D (60.2 W x 105.4 H x 58.7 mm D)

**Weight:**

Approximately 1 lb (0.45 kg)

**Part Number/Price**

PART #	DESCRIPTION	EST. SHIP WEIGHT	PRICE
21145	ISOBLOK® AC two-outlet transient protector	1 lb	\$65.00

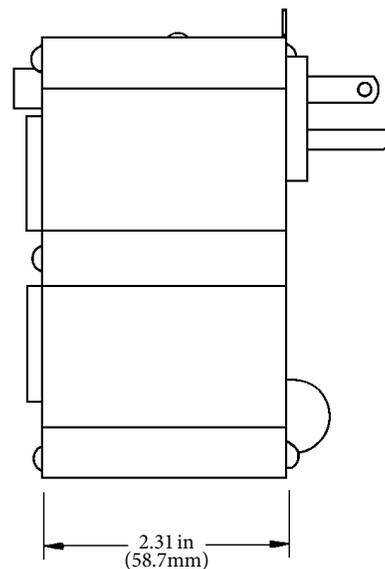
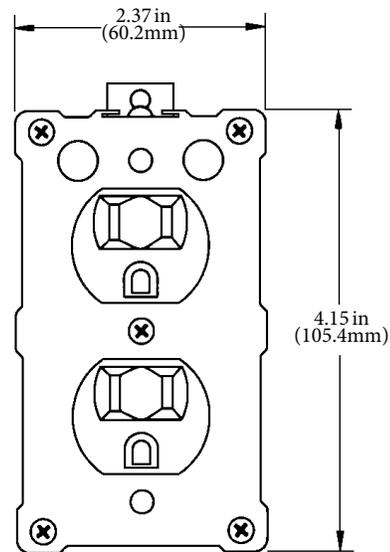



# ISOBAR<sup>®</sup>

## AC Transient Protector

### Standard Features

- Four outlets
- 6-foot cord with grounded three-prong plug
- Lighted on/off switch
- Circuit breaker protected
- Multiple filter design prevents the different components of your system from interfering with each other
- UL1449 listed at 330 volts
- Exclusive isolated filter banks prevent equipment interaction
- ISOBAR's cascade circuitry allows you to choose more protection for your most sensitive equipment and a lesser degree of protection for equipment with more tolerance

### Specifications

**Clamp Voltage:**

140V rms

**Peak Surge Current:**

13,000 Amps

**Clamping Time:**

Less than five nanoseconds

**Input Voltage:**

120VAC

**Maximum Current:**

15 Amps

**Maximum Power:**

1875 Watts

**Noise Suppression:**

Frequency Attenuation

50 KHz > 20 db

150 KHz > 40 db

1 MHz > 80 db

> 6 MHz > 30 db

**Dimensions:**

6.15 W x 3.56 H x 2.48 in D  
(156.2 W x 90.4 H x 63.0 mm D)

**Weight:**

Approximately 2 lb (0.91 kg)

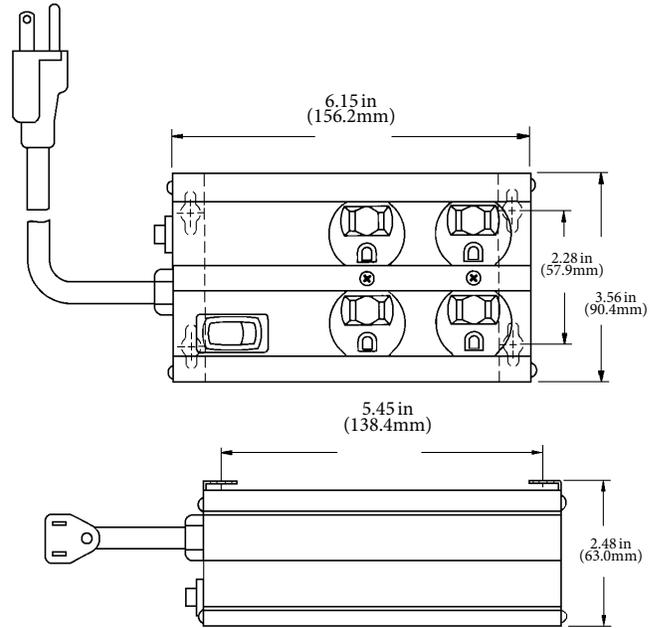

### Part Number/Price

PART #	DESCRIPTION	EST. SHIP WEIGHT	PRICE
21146	ISOBAR <sup>®</sup> AC four-outlet transient protector	2lb	\$110.00
36663	ISOBAR 230VAC Euro	3lb	155.00

# EL226

## AC Transient Protector

### Standard Features

- Duplex receptacle
- 20 ft (6.1 m) ground cable
- Factory serviceable
- 9 ft (2.7 m) cord with three-prong plug
- Stainless steel industrial enclosure
- Plugs into any grounded three-prong outlet
- Indicator light shows protection is secure
- Excellent as a prefilter for voltage regulators
- Reliability and quality top-of-the-line performance
- Shielded line cord for protection against induced transients
- Positive proven protection for scales, computers and printers
- Convenient mounting holes; can be mounted on any surface

### Specifications

**Operating Voltage:**

120VAC 50/60 Hz, nominal

**Maximum Current:**

10A rms instantaneous, 7.5A rms continuous

**Clamping Time:**

Less than 3 to 5 nanoseconds

**EMI/RFI Protection:**

13 stages

**Protection Type:**

13-stage series type filters out both common and normal mode transients

**Grounding:**

20 ft (6.1 m) insulated #10 AWG wire provided

**Enclosure:**

Stainless steel

**Operating Temperature:**

14°F to 104°F (-10°C to 40°C)

**Circuit Board:**

Fiberglass-reinforced 4-glass epoxy

**Dimensions:**

8.00 W x 6.00 H x 2.50 in D (203.2 W x 152.4 H x 63.5 mm D)

**Warranty:**

One-year limited



### Part Number/Price

PART #	DESCRIPTION	EST. SHIP WEIGHT	PRICE
21136	EL226 AC two-outlet transient protector	6 lb	\$370.00

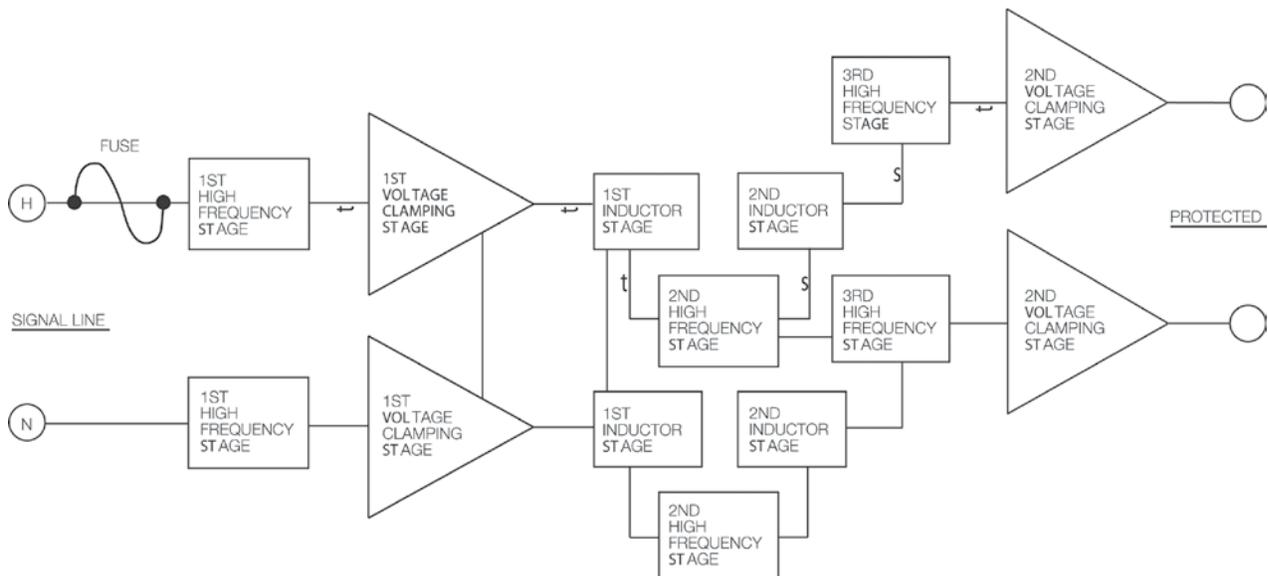

# EL225-4

## Standard Features

- Dedicated series transient protection
- Bidirectional design reduces noise on surrounding lines

## Specifications

**Operating Voltage:**

117 VAC 50/60 Hz, nominal

**Maximum Current:**

2 Amps continuous

**Clamping Time:**

Less than 5 nanoseconds

**Dimensions:**

2 (H) x 2.05 (W) x 4.005 (L) in

**EMI/RFI Protection:**

9 stages

**Protection Type:**

Nine-stage series type filters out both common and normal mode transients

**Grounding:**

20 ft (6.1 m) insulated #10 AWG wire provided

**Operating Temperature:**

14°F to 104°F (-10°C to 40°C)

**Warranty:**

One-year limited



## Part Number/Price

PART #	DESCRIPTION	EST. SHIP WEIGHT	PRICE
21142	EL225-4 AC transient protector (chassis mount)	1 lb	\$285.00

# Sola MCR Series

## Standard Features

- UL listed, CSA certified
- Automatic overload protection
- Convenient lighted on/off switches
- Available in 70, 150 and 250VA outputs
- Offered in standard 120 volt, 60 Hz models
- Two duplex receptacles allow several pieces of equipment to economically share the same source of regulated power

## Specifications

### Input:

Voltage: 120V

Input Voltage Range: +10% to -20% of input nominal voltage

### Control: Lighted Enable Switch Output:

Voltage: 120V

Voltage Regulation:  $\pm 3\%$  for an input line variation of +10% to -20%. Output will remain within NEMA voltage specifications for input voltages as low as 65% of nominal. No loss of output for line loss of 3 milliseconds.

Harmonic Distortion: Less than 3% total RMS content at full load

### Noise Reduction:

Common mode noise rejection exceeds 120 dB (DC to 1 MHz). Transverse mode noise rejection exceeds 60 dB (10 KHz to 1 MHz)

### Protection:

Input: Surge suppression module

Output: Surge suppression module and ferroresonant technology suppresses ANSI/IEEE C62.41-1980 Class A and B waveforms to safe levels (formerly IEEE 587-1980)

### Efficiency:

90% at full load (typical)

### Reliability:

25-year continuous life, average

### Operating Temperature:

-4°F to 122°F (-20°C to 50°C)

### Construction:

Cruciform-type construction with precision die-cut shunts, gaps, and spacing between windings

### Approvals:

UL listed to UL1012; CSA certified to CSA C22.2-66

### Dimensions:

70, 150 & 250 VA - 6.75 W x 6.25 H x 9.25 in D (171.5 W x 158.8 H x 235.0 mm D)

### Weight:

70 VA - Approximately 16 lb (7.3 kg)

150 VA - Approximately 21 lb (9.5 kg)

250 VA - Approximately 26 lb (11.8 kg)

### Warranty:

One-year limited



## APPROVALS



## Part Number/Price

PART #	DESCRIPTION	EST. SHIP WEIGHT	PRICE
21155	Sola MCR 070 AC power regulator, 70 VA	16 lb	\$625.00
21156	Sola MCR 150 AC power regulator, 150 VA	21 lb	1,095.00
21157	Sola MCR 250 AC power regulator, 250 VA	29 lb	1,395.00

# Tripp-Lite PV Series

## Standard Features

- Two conductor outlet
- Convenient on/off switch
- 120VAC 60Hz square wave output
- Transistorized and solid state for long life and quiet operation
- Packaged in a compact, rugged aluminum case

## Specifications

**Input VDC:**

PV-375—12V

**Output VAC:**

PV-375—120VAC

**Frequency Hz:**

PV-375—60 Hz

**Maximum Output Continuous:**

PV-375—375 Watts

**Maximum Output Intermittent:**

PV-375—375 Watts

**Input AMP - No Load:**

PV-375—.65 Amps

**Input AMP - Full load:**

PV-375—40 Amps

**Enclosure:**

Non-sealed aluminum

**Dimensions:**

4.25 W x 2 H x 7 in D

**Warranty:**

One-year limited



## Part Number/Price

PART #	DESCRIPTION	EST. SHIP WEIGHT	PRICE
79679	375VA**, 200VA	7 lb	\$130.00

\* Frequency controlled

\*\* Car charger adapter

# LC1200

## Standard Features

- Maintains usable 120V nominal output during brownouts as low as 87V and overvoltages as high as 140V
- 1,200 Watts output power rating supports heavy 120V loads up to 10 Amps
- Network grade surge suppression rated at 1200 joules
- Complete EMI/RFI noise filtering
- Seven diagnostic LEDs indicate input voltage levels, surge suppression status and line fault conditions
- Protected NEMA5-15R outlets
- 6ft AC power cord with standard NEMA5-15P input plug

## Specifications

### Output Wattage (continuous):

1,200

### Voltage/Frequency:

120/60

### Cordset:

6ft (1.8m)

### AC Receptacles:

Four NEMA 5-15R

### LED Indicators:

Seven (very high voltage, high voltage, normal voltage, low voltage, very low voltage, line fault, line OK)

### Surge Energy Rating (Joules):

1,200

### High Frequency Noise Suppression (@ 1 MHz):

80 dB

### Dimensions:

6.75 H x 5.75 W x 6.75 in D (171.4 H x 146.1 W x 171.4 mm D)

### Ship Weight:

9lb (4kg)

### Warranty:

One-year limited

*NOTE: LC models have isolated filter banks. Each duplex outlet pair is filtered from the rest to prevent interference between connected equipment.*



## Part Number/Price

PART #	DESCRIPTION	EST. SHIP WEIGHT	PRICE
70726	LC1200	11 lb	\$210.00

# Sola S1K/S3K

Uninterruptible Power System

## Standard Features

- Offline with Automatic Voltage Regulation (AVR) topology
- Protects against most adverse power conditions, including: frequency variations, surge, noise, blackouts, lightning, spike, brownouts and over and under voltages
- Data-line surge protection for phone or network included on every unit
- Greater uptime with intelligent power management, full-sequence battery testing and two-level overload protection

## Specifications

### Input Voltage Range (for online operation):

115VAC: +20%/-25%

### Operating Frequency (online):

50/60 Hz  $\pm$ 1 Hz auto sensing

### Overload Capacity:

120%  $\pm$ 10% (3 minutes on line mode, 10 seconds on battery)

### Transfer Time:

Four ms typical

### On Battery Voltage:

115VAC: 115VAC rms  $\pm$ 10%

### Output Voltage Waveform:

Step Sine Wave @ 115V

### Output Protection:

Electronically limited

### Input Protection:

Circuit breaker

### Recharge Time (to 95% capacity):

Four hours

### Lightning & Surge Protection:

ANSI/IEEE C62.41 categories A & B, IEC801.4, 801.5

### Safety Certification:

115VAC: UL listed to 1778, designed to meet UL497A, CSA certified to CSAC22.2 No. 107.1

### EMI Compliance:

115VAC: FCC Class B

### Data Line Protection:

115VAC: fax/modem, network

### Indicators:

Online/utility fail/overload/replace battery

### Audible Alarms:

Utility fail/overload/replace battery

### Dimensions (inches) H x W x D:

S1K: 5.3 x 3.8 x 12.6 in

S2K: 8.3 x 5.5 x 17.2 in

### Warranty:

Two-year limited



## APPROVALS



## Part Number/Price

PART #	MODEL #	CAPACITY (VA/WATTS)	VOLTS, FREQUENCY IN/OUT	TYPICAL BACKUP (MINUTES)	EST. SHIP WEIGHT	INPUT PLUG/ OUTPUT RECEPTACLE	PRICE
110812	520VA S1K	520	115/115,50/60Hz	15	12 lb	5-15P(4) 5-15R	\$325.00
109910	1000VA S3K	1000/750	115/115,50/60Hz	18	39 lb	5-15P(4) 5-15R	850.00

Note: 230VAC versions available. Consult factory.

Note: Air around the above units must be free of dust, chemicals or other materials that corrode or contaminate

# Liebert PSP/PSA

Uninterruptible Power Supply

## Standard Features

- Full sequenced battery testing to ensure batteries are available when needed
- Advanced early warning of UPS shutdown
- AVR Technology (PSA)
- User replaceable batteries

## Specifications

### Input Voltage Range (for online operation):

84-140 VAC

### Operating Frequency (online):

50/60Hz  $\pm$ 5Hz

### Output Voltage Waveform:

Stepped sine wave

### UPS and Surge Protection (both models):

Three battery backed UPS outlets and one surge protection only outlet

### Safety Certification:

UL1778, C-UL Listed

### Data Line Protection:

RJ-45 port for surge protection

### Indicators:

LED alarm

### Alarms:

Audible, LED

### Dimensions:

PSA: 3.7 x 14 x 6.7 in

PSP: 3.4 x 8.5 x 9.9 in

### Warranty:

Two-year limited replacement



## APPROVALS



## Part Number/Price

PART #	MODEL #	CAPACITY (VA/WATTS)	VOLTS, FREQUENCY IN/OUT	FULL LOAD	EST. SHIP WEIGHT	INPUT PLUG/ OUTPUT RECEPTACLE	PRICE
153594	PSP	500/300	115V 50/60Hz	5 minutes	8.8/4.0 kg	NEMA 5 - 15R (3)	\$325.00
153595	PSA	500/300	115V 50/60Hz	5 minutes	15.9/7.2 kg	NEMA 5 - 15R (3)	350.00



# Eaton 3S/5S

Uninterruptible Power Supply

## Standard Features

- Five outlets with surge protection (both)
- Five outlets with battery back up and surge protection
- Coax surge protection (5S)
- Replaceable battery

## Specifications

### Input Voltage Range (for online operation):

89-151 VAC (3S)

93-138 VAC (5S)

### Operating Frequency (online):

50/60 Hz out sensing

### UPS and Surge Protection:

Both models

### Safety Markings:

UL, CUL, NOM

### Data Line Protection:

Yes

### Indicators:

Power, LED

### Alarms:

No

### Dimensions:

Model 3S: 3.4 (H) x 5.5 (W) x 13.2 in (D)

Model 5S: 9.8 (H) x 3.4 (W) x 10.2 in (D)

### Warranty:

Three-year limited warranty



## Part Number/Price

PART #	MODEL #	CAPACITY (VA/WATTS)	VOLTS, FREQUENCY IN/OUT	EST. SHIP WEIGHT	INPUT PLUG/OUTPUT RECEPTACLE	PRICE
154127	Eaton 3S	550 VA/330 W	120 VAC	10 lb	5-15R	\$165.00
154128	Eaton 5S	700 VA/450 W	120 VAC	16 lb	5-15R	350.00



# Precision Industrial Weighing

## Table of Contents

<b>Sartorius® Intec Midrics Series</b> .....	<b>576</b>	<b>Sartorius® Intec PR6201</b> .....	<b>601</b>
Complete Scale		Zinc-Plated Steel Star Mount Kits	
<b>Sartorius® Intec Midrics 2 Series</b> .....	<b>577</b>	<b>Sartorius® Intec PR6201</b> .....	<b>602</b>
Midrics/Combics System		Stainless Steel Star Mount Kits	
<b>Sartorius® Intec Combics 2</b> .....	<b>578</b>	<b>Sartorius® Intec PR6202</b> .....	<b>603</b>
Complete Scale		Hygienic Weigh Module Kits	
<b>Sartorius® Intec Signum Series</b> .....	<b>579</b>	<b>Sartorius® Intec Contego-Hygienic Weigh Module Kits</b> .....	<b>604</b>
Complete Scale		Lateral Cable Outlet	
<b>Sartorius® Intec Midrics® 1 and 2 Series</b> .....	<b>580</b>	<b>Sartorius® Intec Contego-Hygienic Weigh Module Kits</b> .....	<b>605</b>
Digital Weight Indicator		Top Cable Outlet	
<b>Sartorius® Intec Combics 1</b> .....	<b>581</b>	<b>Sartorius® Intec PR5220 Ethernet Transmitter</b> .....	<b>606</b>
Digital Weight Indicators		<b>Sartorius® Intec PR5230 Fieldbus Transmitter</b> .....	<b>607</b>
<b>Sartorius® Intec Combics 2</b> .....	<b>582</b>	<b>Sartorius® Intec PR5610-Pro-X5 System Controller</b> .....	<b>608</b>
Digital Weight Indicators			
<b>Sartorius® Intec Combics 3</b> .....	<b>583</b>		
Digital Weight Indicators			
<b>Sartorius® Intec Combics</b> .....	<b>584</b>		
Bench and Floor Platforms			
<b>Sartorius® Intec IF Series</b> .....	<b>586</b>		
Painted Steel Platforms			
<b>Sartorius® Intec IF Series</b> .....	<b>588</b>		
Weighing Platforms			
<b>Sartorius® Intec IS Series</b> .....	<b>591</b>		
Weighing Platforms			
<b>Sartorius® Intec Signum EX Supreme</b> .....	<b>593</b>		
Explosion Proof Bench Scale			
<b>Sartorius® Intec Combics 2 EX</b> .....	<b>594</b>		
Explosion Proof Digital Weight Indicators			
<b>Sartorius® Intec Combics</b> .....	<b>595</b>		
Explosion Proof Bench and Floor Platforms			
<b>Sartorius® Intec IF Series</b> .....	<b>597</b>		
Explosion Proof Weighing Platforms			
<b>Sartorius® Intec IS-X</b> .....	<b>600</b>		
Explosion Proof Scales			

**ESPAÑOL** | Visit [ricelake.com/spanish](http://ricelake.com/spanish) to see all RLWS materials available in Spanish

Product names, logos, brands, and other trademarks featured or referred to within this publication are the property of their respective trademark holders.

# Sartorius® Intec Midrics Series

Complete Scale

## Standard Features

- There are hundreds of possible applications for an industrial scale. Not everyone needs a standard “off-the-rack” solution. Whatever, wherever, and however – the Midrics® can do it all:
- Order a complete scale, individual configurations, or separate modules. From 0.2g to 3t, verified or non-verified, with or without EX protection, Zone 2 and 22.
- Painted versions have IP65 protection rating for industrial use
- 304 Stainless steel versions have IP67/IP68 protection ratings
- Four adjustable feet, level indicator on LCE and NCE
- Midrics 1 for simple weighing tasks
- Accessories: user installed interface kits, printer, external battery pack, software tools, panel mount kit.



## Specifications

### Indicators:

- MIS1 - UR 20 mm LCD
- MIS2 - UR with application programs

### Power Supply:

100 - 200VAC, 50 - 60 Hz

### Readability:

15,000 scale intervals

### Cable Length:

1.5 to 6 m (varies by capacity)

### Warranty:

Two-year limited warranty

### Custom Part No. Configuration

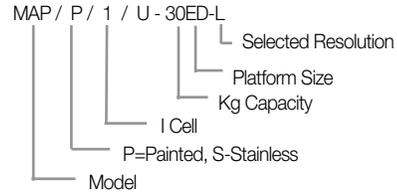

- |                          |                   |
|--------------------------|-------------------|
| DC= 12 x 9.5 x 3.4in     | <b>Capacities</b> |
| ED= 15.8 x 11.8 x 3.4in  | I Cell base       |
| FE = 19.7 x 15.8 x 4.3in | 3kg x .2          |
| GF= 25.6 x 19.7 x 5.6in  | 6kg x .5          |
| IG = 31.5 x 23.6 x 5.6in | 15kg x 1          |
| <b>Kits:</b>             | 30kg x 2          |
| 4 Load Cell Platforms:   | 60kg x 5          |
| KK-36 x 36               | 150kg x 10        |
| NN-48 x 48               | 300kg x 20        |
| RR-60 x 60               |                   |
| 4 Load Cell Capacities   |                   |
| 1500lb x .1              |                   |
| 3000lb x .2              |                   |
| 6000lb x .5              |                   |

## Part Number/Price

RLWS PN	SARTORIUS PN	DIMENSIONS	# LOAD CELLS	CAPACITY	READABILITY	EST. SHIP WEIGHT	PRICE
103668	MW1P1U-6DC-L	12.6 x 9.5 in	1	6 kg	0.5 g	22 lb	\$1,240.00
103669	MW1P1U-15DC-L	12.6 x 9.5 in	1	15 kg	1 g	24 lb	1,240.00
103670	MW1P1U-30ED-L	15.8 x 11.8 in	1	30 kg	2 g	24 lb	1,315.00
103671	MW1P1U-60ED-L	15.8 x 11.8 in	1	60 kg	5 g	24 lb	1,315.00
103672	MW1P1U-60FE-L	19.7 x 15 in	1	60 kg	5 g	22 lb	1,445.00

## Options/Accessories

RLWS PN	SARTORIUS PN	DESCRIPTION	PRICE
	YDH12CWSUS	Holder basemount for ED base	Consult
	YDH02CWSUS	Column for ED base	Consult
	YDH02CISUS	Wall-mount bracket	Consult
	YBP03CIS	Floor-mount option	Consult
	YAS03-M1	Panel mount option	Consult

# Sartorius® Intec Midrics 2 Series

Midrics/Combics System

## Standard Features

- Painted versions have IP65 protection rating for industrial use
- 304 Stainless steel versions have IP67/IP68 protection ratings
- Four adjustable feet, level indicator on LCE and NCE
- Midrics 2 with 10 key touch pad and application programs
- Midrics 2 application programs – counting, checkweighing, classification, totalizing, net-total formulation, animal weighing, percent weighing, neutral measurement
- Ten weighing ranges from 3 kg to 3T
- Accessories: user installed interface kits, printer, external battery pack, software tools, panel mount kit



## Specifications

### Power Supply:

100 - 200VAC, 50 - 60Hz

### Readability:

15,000 scale intervals

### Cable Length:

1.5 to 6 m (varies by capacity)

### Warranty:

Two-year limited warranty

## Part Number/Price

RLWS PN	SARTORIUS PN	DIMENSIONS	CAPACITY	READABILITY	CABLE PLATFORM	EST. SHIP WEIGHT	PRICE
<b>Mild Steel with MIS2-U</b>							
156428	MW2P1UE-10CC-L	10 x 10 in	15 lb (6 kg)	0.0005 lb (0.0002 kg)	10ft	18 lb	\$1,295.00
156429	MW2P1UE-50DD-L	12 x 12 in	60 lb (30 kg)	0.002 lb (0.001 kg)	10ft	22 lb	1,335.00
156430	MW2P1UE-100EE-L	18 x 18 in	150 lb (60 kg)	0.005 lb (0.002 kg)	10ft	63 lb	1,550.00
156431	MW2P1UE-250GG-L*	24 x 24 in	300 lb (150 kg)	0.01 lb (0.005 kg)	10ft	118 lb	2,785.00
<b>Stainless Steel with MIS2-U</b>							
156432	MW2S1UE-10CC-L	10 x 10 in	15 lb (6 kg)	0.0005 lb (0.0002 kg)	10ft	18 lb	1,625.00
156433	MW2S1UE-50DD-L	12 x 12 in	60 lb (30 kg)	0.002 lb (0.001 kg)	10ft	22 lb	1,700.00
156434	MW2S1UE-100EE-L	18 x 18 in	150 lb (60 kg)	0.005 lb (0.002 kg)	10ft	63 lb	2,010.00
156435	MW2S1UE-250GG-L*	24 x 24 in	300 lb (150 kg)	0.01 lb (0.005 kg)	10ft	118 lb	4,865.00

\* Comes with MIS2UR

## Options/Accessories

RLWS PN	SARTORIUS PN	DESCRIPTION	PRICE
156440	YDH01CWSUS	Post mount assembly for 10 x 10 in platforms, 13 in high	\$200.00
156441	YDH02CWSUS	Post mount assembly for 12 x 12 in platforms, 19 in high	275.00
156442	YDH03CWSUS	Post mount assembly for 18 x 18 in platforms, 29 in high	475.00

# Sartorius® Intec Combics 2

Complete Scale

## Standard Features

- Amber backlit LCD display, 0.8 in, 13 segment
- External calibration routine
- RS-232C
- Numeric keypad (with two “IDs”) for entering identifier codes and preset tares
- Info key for quick and easy display of tare input and ID codes
- Date/time fully integrated
- Three built-in LED checkweighing lights
- Bar graph weighing range indicator
- Optional barcode scanner for preset tare, reference weight and ID entry
- Stored customer specific data records
- Two scale connections, analog or digital



Shown with optional Bench Mount Bracket

**Application Note:**

Counting, checkweighing, differential weighing, percentage weighing, gross-net-tare; sorting; net-total, animal weighing, averaging, totalizing

## Specifications

**Supply Voltage:**

9V

**Power Requirements:**

120-240 VAC, 17 W / 23 VA maximum

**Indicator Housing:**

AISI 304 stainless steel

**Indicator Dimensions:**

11.9 W x 7.4 D x 3.5 in H

**Operating Temperature:**

14° F to 104° F (-10° C to 40° C)

**Net Weight:**

5 lb

**Warranty:**

Two-year limited warranty

Accessories one-year

## Part Number/Price

RLWS PN	SARTORIUS PN	DIMENSIONS	CAPACITY	READABILITY	EST. SHIP WEIGHT	PRICE
<b>Mild Steel with CAISL2-U</b>						
156409	CAW2P1U-10CC-I	10 x 10 in	15 lb (6 kg)	0.0005 lb (0.0002 kg)	10 ft	\$1,905.00
156414	CAW2P1U-50DD-I	12 x 12 in	60 lb (30 kg)	0.002 lb (0.001 kg)	10 ft	1,930.00
156420	CAW2P1U-100EE-I	18 x 18 in	150 lb (60 kg)	0.005 lb (0.002 kg)	10 ft	2,215.00
156423	CAW2P1U-250GG-I	24 x 24 in	300 lb (150 kg)	0.01 lb (0.005 kg)	10 ft	2,910.00
<b>Stainless Steel with CAIS2-U</b>						
156424	CAW2S1U-10CC-I	10 x 10 in	15 lb (6 kg)	0.0005 lb (0.0002 kg)	10 ft	2,270.00
156425	CAW2S1U-50DD-I	12 x 12 in	60 lb (30 kg)	0.002 lb (0.001 kg)	10 ft	2,345.00
156426	CAW2S1U-100EE-I	18 x 18 in	150 lb (60 kg)	0.005 lb (0.002 kg)	10 ft	2,635.00
156427	CAW2S4UR-25066-I	24 x 24 in	300 lb (150 kg)	0.01 lb (0.005 kg)	10 ft	5,225.00

## Options/Accessories

RLWS PN	SARTORIUS PN	DESCRIPTION	PRICE
156440	YDH01CWSUS	Post mount assembly for 10 x 10 in platforms, 13 in high	\$200.00
156441	YDH02CWSUS	Post mount assembly for 12 x 12 in platforms, 19 in high	275.00
156442	YDH03CWSUS	Post mount assembly for 18 x 18 in platforms, 29 in high	475.00
Consult	YDH120WSUS	Bench mount bracket	Consult

# Sartorius® Intec Signum Series

Complete Scale

## Standard Features

- The Signum is extremely rugged and resistant, and adapts perfectly to any ambient conditions in an industrial environment.
- Compact scale built as custom.
- Available in three indicator models - 6, 14 or 17 keys
- Available in three weighing technologies - load cell, mechatronic or monolithic
- Resolution 35,000 dd to 350,000 dd
- Built-in motorized calibration weight (Signum Supreme)
- RS-232 output
- IP65



## Specifications

### Platform Size:

13.8 in x 9.5 in (350.5 mm x 241.3 mm)

### Power:

Multi-range, 110-240V

### Operating Temperature:

14° F to 104° F (-10° C to 40° C)

### Measurement Technology:

SIWRDCP-Load cell signum regular  
SIWADCP-Mechatronic cell-advanced  
SIWSDCP-Monolythic-supreme

### Cable Length:

Display: 6 ft approximately

### Warranty:

Two-year limited warranty  
Accessories: one-year limited warranty

## Options/Accessories

RLWS PN	SARTORIUS PN	DESCRIPTION	PRICE
36907	YDP03-OCE	Data Printer, Statistics and T/D Functions, 5ft Cable (requires 83248)	\$1,095.00
31106	6906918	Ribbon	44.00
31103	6906937	Paper	38.00
83248	YCC0-0016MS	Cable, 9.8ft, 12-Pin Round to 25 D-Sub Female	305.00
105607	YDH02CISUS	Wall Mount Bracket	105.00
153218	YDH01PUS	Column for DC platforms, 19 in	295.00
155884	YDH02P	Column to BBP	475.00

WEIGHING TECHNOLOGY	INDICATOR OPTIONS	CAPACITY	READABILITY	INCLUDED
SIWRDCP (Load Cell)	Applications level 1 - Tare, Zero, Weight Toggle OR Application level 3 - Tare, Zero, Counting, Checkweighing, ID's	3, 6, 15, 35, and 60 kg	30,000d	IP65, RS-232, Detachable Display
SIWADCP (Temperature Compensated Load Cell)		7, 16, 35 and 65 kg	70,000d	IP65, RS-232
SIWSDCP (Monolythic)		3, 6, 16 and 35 kg	160,000d-600,000d	IP65, RS-232, Detachable Display

## Part Number/Price

RLWS PN	SARTORIUS PN	DIMENSIONS	# LOAD CELLS	APPLICATION LEVEL	CAPACITY	READABILITY	EST. SHIP WEIGHT	PRICE
103665	SIWADCP-V3	13.8 x 9.5 in	1	1	7 kg	0.1 g	24 lb	\$2,205.00
103666	SIWADCP-V4	13.8 x 9.5 in	1	3	7 kg	0.1 g	24 lb	2,805.00
105853	SIWADCP-V5	13.8 x 9.5 in	1	3	35 kg	0.5 g	24 lb	2,835.00
105854	SIWADCP-V6	13.8 x 9.5 in	1	3	65 kg	1 g	24 lb	2,875.00
103657	SIWRDCP-V7	13.8 x 9.5 in	1	1	6 kg	0.2 g	22 lb	1,755.00
103658	SIWRDCP-V8	13.8 x 9.5 in	1	1	15 kg	0.5 g	24 lb	1,785.00
103659	SIWRDCP-V9	13.8 x 9.5 in	1	1	35 kg	1 g	24 lb	1,785.00
103660	SIWRDCP-V10	13.8 x 9.5 in	1	1	60 kg	2 g	24 lb	1,785.00
151372	SIWSBBPP-V16	7.1 x 7.1 in	1	1	3 kg	0.01 g	16.5 lb	3,905.00
151373	SIWSBBPP-V17	7.1 x 7.1 in	1	1	6 kg	0.01 g	16.5 lb	4,715.00
151374	SIWSDCP-V18	13.8 x 9.5 in	1	1	16 kg	0.1 g	24 lb	4,695.00
151375	SIWSDCP-V19	13.8 x 9.5 in	1	1	35 kg	0.1 g	24 lb	4,850.00
151376	SIWRDCP-V20	13.8 x 9.5 in	1	3	6 kg	0.2 g	24 lb	2,265.00
151377	SIWRDCP-V21	13.8 x 9.5 in	1	3	15 kg	0.5 g	24 lb	2,285.00
151378	SIWRDCP-V22	13.8 x 9.5 in	1	3	35 kg	1 g	24 lb	2,305.00
151379	SIWRDCP-V23	13.8 x 9.5 in	1	3	60 kg	2 g	24 lb	2,325.00
151410	SIWADCP-V24	13.8 x 9.5 in	1	1	16 kg	0.2 g	24 lb	2,115.00
151411	SIWADCP-V25	13.8 x 9.5 in	1	1	35 kg	0.5 g	24 lb	2,125.00

## Options/Accessories

RLWS PN	DESCRIPTION	PRICE
155804	RS-232 cable,, 25-p D-sub M to 9/25-Pin D-sub F	Consult

# Sartorius® Intec Midrics® 1 and 2 Series

Digital Weight Indicator

## Standard Features

- Backlit 14-segment, 20 millimeter LCD display
- 304 stainless steel enclosure, IP65 rated
- Wall-mount bracket

## Midrics 2 Additional Features

- Numerical keyboard

### Applications:

- Weighing
- Counting
- Checkweighing
- Sorting (3 or 5 classes)
- Totalizing
- Net-total
- Animal weighing
- Weighing in percent
- Neutral measurement

## Options

- RS-232
- 4-20 mA

## Specifications

### Load Cell Connection:

Input voltage 8.4V  
4 or 6 conductor

### Power Requirements:

100 - 240VAC (-15/10) 50-60Hz, Max 17W/23VA

### Power Cord:

3 m

### Housing:

304 stainless steel enclosure, IP65

### Dimensions:

9 1/3 x 6 1/2 x 3 3/4 in (238 x 165 x 94 mm)

### Operating Temperature:

14 to 104° F (-10 to 40° C)

### Net Weight:

5 lb (2.3 kg)

### Warranty:

Two-year limited warranty

### Approvals:

NTEP Class III

## Part Number/Price

RLWS PN	SARTORIUS PN	DESCRIPTION	PRICE
155855	MIS1UR-V1	Midrics 1, Wall Bracket	\$685.00
155857	MIS1U-L9	Midrics 1, Wall Bracket, Internal Battery Pack	1,055.00
155856	MIS2UR-V2	Midrics 2, Wall Bracket	785.00
155859	MIS2U-L9	Midrics 2, Wall Bracket, Internal Battery Pack	1,170.00

## Options/Accessories

RLWS PN	SARTORIUS PN	DESCRIPTION	PRICE
103044	YDA01M-20MA	Analog current output, 0-20 mA, 4-20 mA, 0-10V (16-bit)	435.00
155805	YCC01-USBM2	Connecting cable from RS-232 to USB Connector, 2 m	265.00
155806	YCC02-D25F6	Connecting cable for accessories 25-Pin D-SUB Female	230.00
Consult	YAS03-M1	Panel mount option	





# Sartorius® Intec Combics 1

## Digital Weight Indicators

### Standard Features

- IP protection rating, IP44, IP69K
- Amber backlit LCD display, .8 in
- External calibration routine
- RS-232C
- On/Off, Zero, Tare, Print/Data Key
- Function Keys For: Gross/net toggle; three-way unit toggle; 10X higher resolution toggle
- Automatic tare feature
- One scale connection

### Specifications

**Load Cell Connection:**

4 or 6 wire

**Supply Voltage:**

9V

**Power Requirements:**

120-240VAC, 17W/23VA maximum

**Housing:**

AISI 304 stainless steel

**Dimensions:**

11.9 W x 7.4 D x 3.5 in H

**Operating Temperature:**

14° to 104° F (-10° C to 40° C)

**Net Weight:**

5 lb

**Warranty:**

Two-year limited warranty

Accessories:-one-year limited warranty



*Application Note:*

*Combics 1 indicator is designed for use with both Combics and IF series platforms. However, various accessories may differ and are application dependent.*

### Part Number/Price

RLWS PN	SARTORIUS PN	DESCRIPTION	EST. SHIP WEIGHT	PRICE
102396	CAISL1-U	IP44 protection rated	7.5 lb	\$1,055.00
102398	CAIS1-U	IP69K protection rated	7.5 lb	1,385.00
115668	CAISL1-UV1	IP44, IS Base controller	7.5 lb	1,535.00
115671	CAIS1-UV1	IP69K, IS Base controller	7.5 lb	1,685.00

### Options/Accessories

RLWS PN	SARTORIUS PN	DESCRIPTION	PRICE
105607	YDH02CISUS	Wall mount bracket	\$105.00
156440	YDH01CWSUS	Post mount assembly for 10 x 10 in platforms, 13 in high	200.00
156441	YDH02CWSUS	Post mount assembly for 12 x 12 in platforms, 19 in high	275.00
156442	YDH03CWSUS	Post mount assembly for 18 x 18 in platforms, 29 in high	475.00
103049	YAS02C1	24 V industrial power supply	245.00
162640	YD002C-ETH	Ethernet TCP/IP	725.00
155826	YD002C-A0	Analog output, 0-20mA, 4-20mA, 0-10V	725.00
<b>Cables</b>			
155804	YCC05-001M2	RS-232 9/25-Pin D-SUB female, 1.5 m, IP44	100.00
155805	YCC01-USBM2	RS-232 to USB connector, 2 m IP44	265.00
155806	YCC02-D25F6	RS-232 open to 25 D-SUB female	230.00

# Sartorius® Intec Combics 2

Digital Weight Indicators

## Standard Features

- Choice of IP protection rating (IP44, IP69K)
- Amber backlit LCD display, .8in, 13 segment
- External calibration routine
- RS-232C
- On/Off, Zero, Tare, Print/Data Keys
- Function Keys For: Gross/net toggle; three-way unit toggle; 10X higher resolution toggle
- Numeric keypad with two "ID" for entering identifier codes and preset tare
- Info key for quick and easy display of tare input and ID codes
- Date/time fully integrated
- GMP compliant printable record
- NICE Label Express FlexiPrint compatible
- Platform toggling and four function keys
- Three built-in LED checkweighing lights
- Bar graph weighing range indicator
- Application data and totalization memory stored in battery-backed RAM
- Optional barcode scanner for preset tare, reference weight and ID entry
- Stored customer specific data records
- Optional two scale connections, analog or digital



**Application Note:**

Combics 2 and Combics 3 indicators are designed for use with both Combics and IF series platforms. However, various accessories may differ and are application dependent.

**Applications Software Pre-Installed**

Counting, checkweighing, differential weighing, percentage weighing, gross-net-tare; sorting; net-total, animal weighing, averaging, totalizing

## Specifications

**Load Cell Connection:**

4 or 6 wire

**Supply Voltage:**

9V

**Power Requirements:**

120-240VAC, 17W / 23VA maximum

**Housing:**

AISI 304 stainless steel

**Dimensions:**

11.9 W x 7.4 D x 3.5 in H

**Operating Temperature:**

14° F to 104° F (-10° C to 40° C)

**Net Weight:**

5 lb

**Warranty:**

Two-year limited warranty

Accessories: One-year limited warranty

## Part Number/Price

RLWS PN	SARTORIUS PN	DESCRIPTION	EST. SHIP WEIGHT	PRICE
102402	CAISL2-U	IP44 Protection rated	7.5 lb	\$1,315.00
102404	CAIS2-U	IP69K Protection Rated	7.5 lb	1,650.00
115670	CAISL2-UV1	IP44, IS Base Controller	7.5 lb	1,785.00
115673	CAIS2-UV1	IP69K, IS Base Controller	7.5 lb	2,035.00

## Options/Accessories

RLWS PN	SARTORIUS PN	DESCRIPTION	PRICE
105607	YDH02CISUS	Wall Mount Bracket	\$105.00
156440	YDH01CWSUS	Post mount assembly for 10 x 10 in platforms, 13 in high	200.00
156441	YDH02CWSUS	Post mount assembly for 12 x 12 in platforms, 19 in high	275.00
156442	YDH03CWSUS	Post mount assembly for 18 x 18 in platforms, 29 in high	475.00
103049	YAS02C1	24V industrial power supply	245.00
162640	YD002C-ETH	Ethernet TCP/IP	725.00
155826	YD002C-A0	Analog output, 0-20mA, 4-20mA, 0-10V	725.00
<b>Cables</b>			
155804	YCC05-001M2	RS-232 9/25-Pin D-SUB female, 1.5 m, IP44	100.00
155805	YCC01-USBM2	RS-232 to USB connector, 2 m IP44	265.00
155806	YCC02-D25F6	RS-232 open to 25 D-SUB female	230.00

# Sartorius® Intec Combics 3

## Digital Weight Indicators

### Standard Features

- IP protection rating (IP44, IP69K)
- Amber backlit LCD display
- On/Off Zero, Tare, Print/Data Keys
- Function Keys For: Gross/net toggle; 3-way unit toggle; 10X higher resolution toggle
- Keypad with two ID for entering identifier codes and preset tare
- Info key for quick and easy display of tare input and ID codes
- Date/time fully integrated
- GMP/GLP printable record
- Platform toggling and four function keys
- Three built-in LED checkweighing lights
- Bar graph weighing range indicator
- Application data and totalization memory stored in battery-backed RAM
- Optional barcode scanner for preset tare, reference weight and ID entry
- Stored customer specific data records
- Key for toggling between weighing application, and five soft keys with text-supported user guidance
- Input functions for entering up to four alphanumeric ID texts



*Applications Software Pre-Installed*  
 Counting, checkweighing, differential weighing, percentage weighing, gross-net-tare; sorting; net-total, animal weighing  
*Custom Applications Packages*  
 Single component batching BASIC  
 Single component batching PRO

### Specifications

**Load Cell Connection:**

4 or 6 wire

**Supply Voltage:**

9V

**Power Requirements:**

120-240VAC, 17W / 23VA maximum

**Housing:**

AISI 304 stainless steel

**Dimensions:**

11.9 W x 7.4 D x 3.5 in H

**Operating Temperature:**

14° F to 104° F (-10° C to 40° C)

**Net Weight:**

5 lb

**Warranty:**

Two-year limited warranty  
 Accessories: One-year limited warranty

### Part Number/Price

RLWS PN	SARTORIUS PN	DESCRIPTION	EST. SHIP WEIGHT	PRICE
102405	CAISL3-U	IP44 Protection rated	7.5 lb	\$1,755.00
Consult	CAISL3-UV1	IP44, IS Base Controller	7.5 lb	Consult
102407	CAIS3-U	IP69K Protection Rated	7.5 lb	2,085.00
115674	CAIS3-UV1	IP69K, IS Base Controller	7.5 lb	2,405.00

### Options/Accessories

RLWS PN	SARTORIUS PN	DESCRIPTION	PRICE
105607	YDH02CISUS	Wall Mount Bracket	\$105.00
156440	YDH01CWSUS	Post mount assembly for 10 x 10 in platforms, 13 in high	200.00
156441	YDH02CWSUS	Post mount assembly for 12 x 12 in platforms, 19 in high	275.00
156442	YDH03CWSUS	Post mount assembly for 18 x 18 in platforms, 29 in high	475.00
103049	YAS02C1	24V industrial power supply	245.00
155826	YDO02C-A0	Analog output, 0-20mA, 4-20mA, 0-10V	725.00
162640	YDO02C-ETH	Ethernet TCP-IP	725.00
<b>Cables</b>			
155804	YCC05-001M2	RS-232 9/25-Pin D-SUB female, 1.5 m, IP44	85.00
155805	YCC01-USBM2	RS-232 to USB connector, 2 m IP44	265.00
155806	YCC02-D25F6	RS-232 open to 25 D-SUB female	250.00

# Sartorius® Intec Combics

Bench and Floor Platforms

## Standard Features

- One or four load cells (as noted)
- Complete selection of pit frames for flush mounting available
- NTEP (up to 5000e) and high resolution 30,000dd versions available
- Compatible with all Combics indicators

### Mild Steel

- NEMA4/IP65 protection rating
- Zinc plated steel frame for bases up to 30 in x 30 in
- Painted steel frame platform for bases 36 in x 36 in and larger
- 304 stainless steel platters

### Stainless Steel

- IP67/NEMA4X-cell/IP68/4 cell systems
- 304 stainless steel
- Hermetically-sealed, IP68 load cells

## Optional Configurations

- R2 - Electropolished 316T, stainless steel
- Ti - Pressure lift system
- Drive on ramps
- Pit frame

## Specifications

### Cable Length:

- 10 ft/3 m-up to 1000 lb 30 in x 30 in
- 20 ft/6 m 1000 lb and above 36 in x 36 in

### Operating Temperature:

- 14° F to 104° F (-10° C to 40° C)

### Height:

- Adjustable feet

### Warranty:

- Two-year limited warranty
- Accessories: one-year limited warranty



*Pictured with optional Indicator*

## APPROVALS



# Sartorius® Intec Combics

Painted/Stainless Steel

## Part Number/Price

RLWS PN	SARTORIUS PN	DIMENSIONS	FOOT ADJUSTABLE HEIGHT	# LOAD CELLS	CAPACITY READABILITY NON-NTEP		CAPACITY READABILITY NON-NTEP		EST. SHIP WEIGHT	PRICE
<b>Painted Steel</b>										
102285	CAPP1U-10CC-LU	10 x 10 in	2.7 - 3.6 in	1	15 lb	0.0005	6 kg	0.002	14 lb	\$715.00
102286	CAPP1U-20CC-LU	10 x 10 in	2.7 - 3.6 in	1	30 lb	0.001	15 kg	0.0005	14 lb	715.00
102287	CAPP1U-50CC-LU	10 x 10 in	2.7 - 3.6 in	1	60 lb	0.002	30 kg	0.001	14 lb	715.00
102288	CAPP1U-50DD-LU	12 x 12 in	3.6 - 4.5 in	1	60 lb	0.002	30 kg	0.001	18 lb	785.00
102291	CAPP1U-100DD-LU	12 x 12 in	3.6 - 4.5 in	1	150 lb	0.005	60 kg	0.002	18 lb	785.00
102289	CAPP1U-50EE-LU	18 x 18 in	3.5 - 4.4 in	1	60 lb	0.002	30 kg	0.001	64 lb	1,050.00
102292	CAPP1U-100EE-LU	18 x 18 in	3.5 - 4.4 in	1	150 lb	0.005	60 kg	0.002	64 lb	1,050.00
102297	CAPP1U-200EE-LU	18 x 18 in	3.5 - 4.4 in	1	200 lb	0.01	100 kg	0.005	64 lb	1,050.00
102294	CAPP1U-100GG-LU	24 x 24 in	5.7 - 6.7 in	1	150 lb	0.005	60 kg	0.002	121 lb	1,805.00
102299	CAPP1U-250GG-LU	24 x 24 in	5.9 - 6.4 in	1	300 lb	0.01	150 kg	0.005	121 lb	1,805.00
102302	CAPP1U-500GG-LU	24 x 24 in	5.7 - 6.7 in	1	600 lb	0.02	300 kg	0.01	121 lb	1,805.00
102296	CAPP1U-100HH-LU	30 x 30 in	5.71 - 6.71 in	1	150 lb	0.005	60 kg	0.002	187 lb	2,365.00
102301	CAPP1U-250HH-LU	30 x 30 in	5.71 - 6.71 in	1	300 lb	0.01	150 kg	0.005	187 lb	2,365.00
102304	CAPP1U-500HH-LU	30 x 30 in	5.71 - 6.71 in	1	600 lb	0.02	300 kg	0.01	187 lb	2,365.00
102306	CAPP1U-1000HH-LU	30 x 30 in	5.71 - 6.71 in	1	1500 lb	0.05	600 kg	0.02	187 lb	2,365.00
<b>Pit Frames</b>										
104313	YEG-HG-PUS	30 x 24 in (HG)								850.00
104314	YEG-HH-PUS	30 X 30 in (HH)								880.00
104315	YPF01KKP-MUS	36 x 36 in (KK)								945.00
<b>Stainless Steel</b>										
102429	CAPS1U-10CC-LU	10 x 10 in	2.6 - 3.4 in	1	15 lb	0.0005	6 kg	0.0002	16 lb	945.00
102430	CAPS1U-20CC-LU	10 x 10 in	2.6 - 3.4 in	1	30 lb	0.001	15 kg	0.0005	16 lb	945.00
102431	CAPS1U-50CC-LU	10 x 10 in	2.6 - 3.4 in	1	60 lb	0.002	30 kg	0.001	16 lb	945.00
102432	CAPS1U-50DD-LU	12 x 12 in	3.3 - 4.4 in	1	60 lb	0.002	30 kg	0.001	24 lb	1,055.00
102433	CAPS1U-100DD-LU	12 x 12 in	3.5 - 4.4 in	1	150 lb	0.005	60 kg	0.002	24 lb	1,055.00
102434	CAPS1U-50EE-LU	18 x 18 in	3.5 - 4.4 in	1	60 lb	0.002	30 kg	0.001	62 lb	1,305.00
102435	CAPS1U-100EE-LU	18 x 18 in	3.5 - 4.4 in	1	150 lb	0.005	60 kg	0.002	62 lb	1,305.00
102436	CAPS1U-200EE-LU	18 x 18 in	3.5 - 4.4 in	1	200 lb	0.01	100 kg	0.005	62 lb	1,305.00
102458	CAPS4U-100GG-LU	24 x 24 in	3.4 - 3.6 in	4	150 lb	0.005	60 kg	0.002	121 lb	3,835.00
102460	CAPS4U-250GG-LU	24 x 24 in	3.4 - 3.6 in	4	300 lb	0.01	150 kg	0.005	121 lb	3,835.00
102461	CAPS4U-500GG-LU	24 x 24 in	3.4 - 3.6 in	4	600 lb	0.02	300 kg	0.01	121 lb	3,835.00
102466	CAPS4U-100HH-LU	30 x 30 in	3.4-3.6 in	4	150 lb	0.005	60 kg	0.002	187 lb	4,235.00
102467	CAPS4U-250HH-LU	30 x 30 in	3.4 - 3.6 in	4	300 lb	0.01	150 kg	0.005	187 lb	4,235.00
102468	CAPS4U-500HH-LU	30 x 30 in	3.4 - 3.6 in	4	600 lb	0.02	300 kg	0.01	187 lb	4,235.00
102469	CAPS4U-1000HH-LU	30 x 30 in	3.4 - 3.6 in	4	1500 lb	0.05	600 kg	0.02	187 lb	4,235.00
102470	CAPS4U-1000KK-LU	36 x 36 in	3.5 in	4	1500 lb	0.05	600 kg	0.02	250 lb	3,805.00
102471	CAPS4U-2500KK-LU	36 x 36 in	3.5 in	4	3000 lb	0.1	1500 kg	0.05	250 lb	3,805.00
102472	CAPS4U-5000KK-LU	36 x 36 in	3.5 in	4	6000 lb	0.2	3000 kg	0.1	250 lb	3,805.00
102473	CAPS4U-1000NN-LU	48 x 48 in	3.5 in	4	1500 lb	0.05	600 kg	0.02	390 lb	4,695.00
102474	CAPS4U-2500NN-LU	48 x 48 in	3.5 in	4	3000 lb	0.1	1500 kg	0.05	390 lb	4,695.00
102475	CAPS4U-5000NN-LU	48 x 48 in	3.5 in	4	6000 lb	0.2	3000 kg	0.1	390 lb	4,695.00
<b>Pit Frames</b>										
104320	YEG-HG-SUS	30 x 24 in (HG)								2,025.00
104322	YEG-HH-SUS	30 X 30 in (HH)								2,265.00
104323	YPF01KKT-MUS	36 x 36 in (KK)								2,475.00
104324	YPF01NNT-MUS	48 x 48 in (NN)								2,975.00

# Sartorius® Intec IF Series

Painted Steel Platforms

## Standard Features

- Various options for portability utilizing unique MoveLine weighing platform
- Four strain gauge stainless steel load cells ensure precise results
- Ultra low profile: standard platform height
- Material/surface finish: mild steel powder coated
- Resolution: scale intervals of 15,000 d or 30,000 d
- Drive-on ramp included with every platform
- No pit required
- IP65/NEMA4 dust and water protection

## Applications

- Pharmaceutical, chemical, electronics, food processing, precious metals, metal production and processing

## Optional Configurations

- T14: Integrated column
- T4: Stop bar
- T15: 2nd ramp

## Specifications

**Ingress Protection Rating:**  
IP68

**Load Cells:**  
Four hermetically sealed IP68

**Cable Length:**  
6 m (19.7 ft)

**Platform Height:**  
GG, IG, II, LG - 25 mm  
LI, LL, NL - ≤ 1000 kg = 25 mm  
1500 kg = 35 mm  
3000 kg = 45 mm  
RN ≤ 600 kg = 25 mm  
1000 kg = 35 mm  
≥ 1500 kg = 45 mm  
RR, WR ≤ 600 kg = 35 mm  
≥ 1000 kg = 45 mm

**Regulatory Compliance:**  
HACCP, FDA

**Warranty:**  
Two-year limited warranty



Optional Handles

## Part Number/Price

RLWS PN	SARTORIUS PN	DIMENSIONS	# LOAD CELLS	CAPACITY READABILITY		CAPACITY READABILITY		EST. SHIP WEIGHT	PRICE
100970	IFP4-150GG-I	23.6 x 23.6 in	4	330 lb	0.01	150 kg	0.005	198 lb	\$7,205.00
100973	IFP4-300GG-I	23.6 x 23.6 in	4	660 lb	0.02	300 kg	0.01	198 lb	7,205.00
100974	IFP4-600GG-I	23.6 x 23.6 in	4	1320 lb	0.05	600 kg	0.02	198 lb	7,205.00
100975	IFP4-1000GG-I	23.6 x 23.6 in	4	2200 lb	0.1	1000 kg	0.05	198 lb	7,205.00
100984	IFP4-150IG-I	31.5 x 23.6 in	4	330 lb	0.01	150 kg	0.005	221 lb	7,310.00
100986	IFP4-300IG-I	31.5 x 23.6 in	4	660 lb	0.02	300 kg	0.01	221 lb	7,310.00
100987	IFP4-600IG-I	31.5 x 23.6 in	4	1320 lb	0.05	600 kg	0.02	221 lb	7,310.00
100988	IFP4-1000IG-I	31.5 x 23.6 in	4	2200 lb	0.1	1000 kg	0.05	221 lb	7,310.00
100991	IFP4-150II-I	31.5 x 31.5 in	4	330 lb	0.01	150 kg	0.005	243 lb	7,380.00
100992	IFP4-300II-I	31.5 x 31.5 in	4	660 lb	0.02	300 kg	0.01	243 lb	7,380.00
100993	IFP4-600II-I	31.5 x 31.5 in	4	1320 lb	0.05	600 kg	0.02	243 lb	7,380.00
100994	IFP4-1000II-I	31.5 x 31.5 in	4	2200 lb	0.1	1000 kg	0.05	243 lb	7,380.00
100995	IFP4-1500II-I	31.5 x 31.5 in	4	3300 lb	0.1	1500 kg	0.05	243 lb	7,380.00
101005	IFP4-150LG-I	39.4 x 23.6 in	4	330 lb	0.01	150 kg	0.005	243 lb	7,380.00
101006	IFP4-300LG-I	39.4 x 23.6 in	4	660 lb	0.02	300 kg	0.01	243 lb	7,380.00

# Sartorius® Intec IF Series

Painted Steel Platforms

## Part Number/Price

RLWS PN	SARTORIUS PN	DIMENSIONS	# LOAD CELLS	CAPACITY READABILITY		CAPACITY READABILITY		EST. SHIP WEIGHT	PRICE
101007	IFP4-600LG-I	39.4 x 23.6 in	4	1320 lb	0.05	600 kg	0.02	243 lb	\$7,380.00
101008	IFP4-1000LG-I	39.4 x 23.6 in	4	2200 lb	0.1	1000 kg	0.05	243 lb	7,380.00
101009	IFP4-1500LG-I	39.4 x 23.6 in	4	3300 lb	0.1	1500 kg	0.05	243 lb	7,380.00
101010	IFP4-150LI-I	39.4 x 31.5 in	4	330 lb	0.01	150 kg	0.005	265 lb	7,480.00
101011	IFP4-300LI-I	39.4 x 31.5 in	4	660 lb	0.02	300 kg	0.01	265 lb	7,480.00
101012	IFP4-600LI-I	39.4 x 31.5 in	4	1320 lb	0.05	600 kg	0.02	265 lb	7,480.00
101013	IFP4-1000LI-I	39.4 x 31.5 in	4	2200 lb	0.1	1000 kg	0.05	265 lb	7,480.00
101014	IFP4-1500LI-I	39.4 x 31.5 in	4	3300 lb	0.1	1500 kg	0.05	265 lb	7,480.00
101015	IFP4-150LL-I	39.4 x 39.4 in	4	330 lb	0.01	150 kg	0.005	375 lb	7,970.00
101016	IFP4-300LL-I	39.4 x 39.4 in	4	660 lb	0.02	300 kg	0.01	375 lb	7,970.00
101017	IFP4-600LL-I	39.4 x 39.4 in	4	1320 lb	0.05	600 kg	0.02	375 lb	7,970.00
101018	IFP4-1000LL-I	39.4 x 39.4 in	4	2200 lb	0.1	1000 kg	0.05	375 lb	7,970.00
101019	IFP4-1500LL-I	39.4 x 39.4 in	4	3300 lb	0.1	1500 kg	0.05	376 lb	7,970.00
101020	IFP4-3000LL-I	39.4 x 39.4 in	4	6600 lb	0.2	3000 kg	0.1	376 lb	7,970.00
101021	IFP4-150NL-I	49.2 x 39.4 in	4	330 lb	0.01	150 kg	0.005	397 lb	8,125.00
101022	IFP4-300NL-I	49.2 x 39.4 in	4	660 lb	0.02	300 kg	0.01	397 lb	8,125.00
101023	IFP4-600NL-I	49.2 x 39.4 in	4	1320 lb	0.05	600 kg	0.02	397 lb	8,125.00
101024	IFP4-1000NL-I	49.2 x 39.4 in	4	2200 lb	0.1	1000 kg	0.05	397 lb	8,125.00
101025	IFP4-1500NL-I	49.2 x 39.4 in	4	3300 lb	0.1	1500 kg	0.05	397 lb	8,125.00
101026	IFP4-3000NL-I	49.2 x 39.4 in	4	6600 lb	0.2	3000 kg	0.1	397 lb	8,125.00
101027	IFP4-150NN-I	49.2 x 49.2 in	4	330 lb	0.01	150 kg	0.005	481 lb	8,430.00
101028	IFP4-300NN-I	49.2 x 49.2 in	4	660 lb	0.02	300 kg	0.01	481 lb	8,430.00
101029	IFP4-600NN-I	49.2 x 49.2 in	4	1320 lb	0.05	600 kg	0.02	481 lb	8,430.00
101030	IFP4-1000NN-I	49.2 x 49.2 in	4	2200 lb	0.1	1000 kg	0.05	481 lb	8,430.00
101031	IFP4-1500NN-I	49.2 x 49.2 in	4	3300 lb	0.1	1500 kg	0.05	481 lb	8,430.00
101032	IFP4-3000NN-I	49.2 x 49.2 in	4	6600 lb	0.2	3000 kg	0.1	481 lb	8,430.00
101033	IFP4-150RN-I	59.1 x 49.2 in	4	330 lb	0.01	150 kg	0.005	547 lb	8,880.00
101034	IFP4-300RN-I	59.1 x 49.2 in	4	660 lb	0.02	300 kg	0.01	547 lb	8,880.00
101035	IFP4-600RN-I	59.1 x 49.2 in	4	1320 lb	0.05	600 kg	0.02	547 lb	8,880.00
101036	IFP4-1000RN-I	59.1 x 49.2 in	4	2200 lb	0.1	1000 kg	0.05	547 lb	8,880.00
101037	IFP4-1500RN-I	59.1 x 49.2 in	4	3300 lb	0.1	1500 kg	0.05	547 lb	8,880.00
101038	IFP4-3000RN-I	59.1 x 49.2 in	4	6600 lb	0.2	3000 kg	0.1	547 lb	8,880.00
101039	IFP4-150RR-I	59.1 x 59.1 in	4	330 lb	0.01	150 kg	0.005	628 lb	9,370.00
101040	IFP4-300RR-I	59.1 x 59.1 in	4	660 lb	0.02	300 kg	0.01	628 lb	9,370.00
101041	IFP4-600RR-I	59.1 x 59.1 in	4	1320 lb	0.05	600 kg	0.02	628 lb	9,370.00
101042	IFP4-1000RR-I	59.1 x 59.1 in	4	2200 lb	0.1	1000 kg	0.05	628 lb	9,370.00
101043	IFP4-1500RR-I	59.1 x 59.1 in	4	3300 lb	0.1	1500 kg	0.05	628 lb	9,370.00
101044	IFP4-3000RR-I	59.1 x 59.1 in	4	6600 lb	0.2	3000 kg	0.1	628 lb	9,370.00
101045	IFP4-150WR-I	78.7 x 59.1 in	4	330 lb	0.01	150 kg	0.005	739 lb	9,680.00
101046	IFP4-300WR-I	78.7 x 59.1 in	4	660 lb	0.02	300 kg	0.01	739 lb	9,680.00
101047	IFP4-600WR-I	78.7 x 59.1 in	4	1320 lb	0.05	600 kg	0.02	739 lb	9,680.00
101048	IFP4-1000WR-I	78.7 x 59.1 in	4	2200 lb	0.1	1000 kg	0.05	739 lb	9,680.00
101049	IFP4-1500WR-I	78.7 x 59.1 in	4	3300 lb	0.1	1500 kg	0.05	739 lb	9,680.00
101050	IFP4-3000WR-I	78.7 x 59.1 in	4	6600 lb	0.2	3000 kg	0.1	739 lb	9,680.00

# Sartorius® Intec IF Series

Stainless Steel Platforms

## Standard Features

- Each IF Series stainless steel platform is built with an IP68 protection rating
- Capacities from 150 to 3000 kg with resolutions up to 30,000 d
- Various portability options utilizing the unique MoveLine weighing platform
- Pressure lift option
- Ultra low profile: standard platform height
- Material/surface finish: 304 bead-blasted stainless steel
- Drive-on ramp included with every platform
- No pit required
- Convenient for application-oriented weighing systems from processing to the chemical industry
- All units built for easy cleaning and disinfection to meet HACCP and FDA requirements for the food/pharmaceutical industries

## Optional Configurations

- L6: IP69K kit
- T4: Stop bar
- T9: Bottom plate
- T5: Towing bar
- T6: Two handles, two rollers
- T13: Four handles
- T14: Integrated column
- T15: 2nd ramp

## Applications

- Pharmaceutical, chemical, electronics, food processing, precious metals, metal production and processing

## Specifications

**Ingress Protection Rating:**  
IP68

**Load Cells:**  
Four hermetically sealed IP68

**Cable Length:**  
6 m (19.7 ft)

**Platform Height:**  
GG, IG, II, LG - 25 mm  
LI, LL, NL ≤ 1000 kg = 25 mm  
1500 kg = 35 mm  
3000 kg = 45 mm  
RN ≤ 600 kg = 25 mm  
1000 kg = 35 mm  
≥ 1500 kg = 45 mm  
RR, WR ≤ 600 kg = 35 mm  
≥ 1000 kg = 45 mm

**Regulatory Compliance:**  
HACCP, FDA, Class 10,000 clean rooms  
(US Federal Standard 209D)

**Warranty:**  
Two-year limited warranty



Optional Handles



# Sartorius® Intec IF Series

Stainless Steel Platforms

## Part Number/Price

RLWS PN	SARTORIUS PN	DIMENSIONS	# LOAD CELLS	CAPACITY READABILITY		CAPACITY READABILITY		EST. SHIP WEIGHT	PRICE
101266	IFS4-150GG-I	23.6 x 23.6 in	4	330 lb	0.01	150 kg	0.005	198 lb	\$10,985.00
101267	IFS4-300GG-I	23.6 x 23.6 in	4	660 lb	0.02	300 kg	0.01	198 lb	10,985.00
101268	IFS4-600GG-I	23.6 x 23.6 in	4	1320 lb	0.05	600 kg	0.02	198 lb	10,985.00
101269	IFS4-1000GG-I	23.6 x 23.6 in	4	2200 lb	0.1	1000 kg	0.05	198 lb	10,560.00
101270	IFS4-150IG-I	31.5 x 23.6 in	4	330 lb	0.01	150 kg	0.005	221 lb	11,180.00
101274	IFS4-300IG-I	31.5 x 23.6 in	4	660 lb	0.02	300 kg	0.01	221 lb	11,180.00
101275	IFS4-600IG-I	31.5 x 23.6 in	4	1320 lb	0.05	600 kg	0.02	221 lb	11,180.00
101279	IFS4-1000IG-I	31.5 x 23.6 in	4	2200 lb	0.1	1000 kg	0.05	221 lb	11,180.00
101281	IFS4-150II-I	31.5 x 31.5 in	4	330 lb	0.01	150 kg	0.005	243 lb	11,380.00
101282	IFS4-300II-I	31.5 x 31.5 in	4	660 lb	0.02	300 kg	0.01	243 lb	11,380.00
101283	IFS4-600II-I	31.5 x 31.5 in	4	1320 lb	0.05	600 kg	0.02	243 lb	11,380.00
101284	IFS4-1000II-I	31.5 x 31.5 in	4	2200 lb	0.1	1000 kg	0.05	243 lb	11,380.00
101285	IFS4-1500II-I	31.5 x 31.5 in	4	3300 lb	0.1	1500 kg	0.05	243 lb	11,380.00
101286	IFS4-150LG-I	39.4 x 23.6 in	4	330 lb	0.01	150 kg	0.005	243 lb	11,780.00
101287	IFS4-300LG-I	39.4 x 23.6 in	4	660 lb	0.02	300 kg	0.01	243 lb	11,780.00
101288	IFS4-600LG-I	39.4 x 23.6 in	4	1320 lb	0.05	600 kg	0.02	243 lb	11,780.00
101289	IFS4-1000LG-I	39.4 x 23.6 in	4	2200 lb	0.1	1000 kg	0.05	243 lb	11,780.00
101290	IFS4-1500LG-I	39.4 x 23.6 in	4	3300 lb	0.1	1500 kg	0.05	243 lb	11,780.00
101291	IFS4-150LI-I	39.4 x 31.5 in	4	330 lb	0.01	150 kg	0.005	265 lb	12,190.00
101293	IFS4-300LI-I	39.4 x 31.5 in	4	660 lb	0.02	300 kg	0.01	265 lb	12,190.00
101294	IFS4-600LI-I	39.4 x 31.5 in	4	1320 lb	0.05	600 kg	0.02	265 lb	12,190.00
101295	IFS4-1000LI-I	39.4 x 31.5 in	4	2200 lb	0.1	1000 kg	0.05	265 lb	12,190.00
101296	IFS4-1500LI-I	39.4 x 31.5 in	4	3300 lb	0.1	1500 kg	0.05	265 lb	12,190.00
101304	IFS4-150LL-I	39.4 x 39.4 in	4	330 lb	0.01	150 kg	0.005	375 lb	12,770.00
101305	IFS4-300LL-I	39.4 x 39.4 in	4	660 lb	0.02	300 kg	0.01	375 lb	12,770.00
101306	IFS4-600LL-I	39.4 x 39.4 in	4	1320 lb	0.05	600 kg	0.02	375 lb	12,770.00
101307	IFS4-1000LL-I	39.4 x 39.4 in	4	2200 lb	0.1	1000 kg	0.05	375 lb	12,770.00
101308	IFS4-1500LL-I	39.4 x 39.4 in	4	3300 lb	0.1	1500 kg	0.05	375 lb	12,770.00
101309	IFS4-3000LL-I	39.4 x 39.4 in	4	6600 lb	0.2	3000 kg	0.1	375 lb	12,285.00
101310	IFS4-150NL-I	49.2 x 39.4 in	4	330 lb	0.01	150 kg	0.005	397 lb	13,300.00
101311	IFS4-300NL-I	49.2 x 39.4 in	4	660 lb	0.02	300 kg	0.01	397 lb	13,300.00
101312	IFS4-600NL-I	49.2 x 39.4 in	4	1320 lb	0.05	600 kg	0.02	397 lb	13,300.00
101313	IFS4-1000NL-I	49.2 x 39.4 in	4	2200 lb	0.1	1000 kg	0.05	397 lb	13,300.00
101314	IFS4-1500NL-I	49.2 x 39.4 in	4	3300 lb	0.1	1500 kg	0.05	397 lb	13,300.00
101315	IFS4-3000NL-I	49.2 x 39.4 in	4	6600 lb	0.2	3000 kg	0.1	397 lb	13,300.00
101317	IFS4-150NN-I	49.2 x 49.2 in	4	330 lb	0.01	150 kg	0.005	481 lb	13,885.00
101318	IFS4-300NN-I	49.2 x 49.2 in	4	660 lb	0.02	300 kg	0.01	481 lb	13,885.00
101319	IFS4-600NN-I	49.2 x 49.2 in	4	1320 lb	0.05	600 kg	0.02	481 lb	13,885.00
101320	IFS4-1000NN-I	49.2 x 49.2 in	4	2200 lb	0.1	1000 kg	0.05	481 lb	13,885.00
101321	IFS4-1500NN-I	49.2 x 49.2 in	4	3300 lb	0.1	1500 kg	0.05	481 lb	13,885.00
101322	IFS4-3000NN-I	49.2 x 49.2 in	4	6600 lb	0.2	3000 kg	0.1	481 lb	13,885.00
101323	IFS4-150RN-I	59.1 x 49.2 in	4	330 lb	0.01	150 kg	0.005	547 lb	14,435.00
101324	IFS4-300RN-I	59.1 x 49.2 in	4	660 lb	0.02	300 kg	0.01	547 lb	14,435.00
101325	IFS4-600RN-I	59.1 x 49.2 in	4	1320 lb	0.05	600 kg	0.02	547 lb	14,435.00
101326	IFS4-1000RN-I	59.1 x 49.2 in	4	2200 lb	0.1	1000 kg	0.05	547 lb	14,435.00
101327	IFS4-1500RN-I	59.1 x 49.2 in	4	3300 lb	0.1	1500 kg	0.05	547 lb	14,435.00

# Sartorius® Intec IF Series

Painted Steel Platforms

PRECISION INDUSTRIAL WEIGHING

## Part Number/Price

RLWS PN	SARTORIUS PN	DIMENSIONS	# LOAD CELLS	CAPACITY READABILITY		CAPACITY READABILITY		EST. SHIP WEIGHT	PRICE
101328	IFS4-300RN-I	59.1 x 49.2 in	4	6600 lb	0.2	3000 kg	0.1	628 lb	\$14,435.00
101329	IFS4-150RR-I	59.1 x 59.1 in	4	330 lb	0.01	150 kg	0.005	628 lb	14,995.00
101330	IFS4-300RR-I	59.1 x 59.1 in	4	660 lb	0.02	300 kg	0.01	628 lb	14,995.00
101331	IFS4-600RR-I	59.1 x 59.1 in	4	1320 lb	0.05	600 kg	0.02	628 lb	14,995.00
101332	IFS4-1000RR-I	59.1 x 59.1 in	4	2200 lb	0.1	1000 kg	0.05	628 lb	14,995.00
101333	IFS4-1500RR-I	59.1 x 59.1 in	4	3300 lb	0.1	1500 kg	0.05	628 lb	14,995.00
101334	IFS4-3000RR-I	59.1 x 59.1 in	4	6600 lb	0.2	3000 kg	0.1	739 lb	14,995.00
101335	IFS4-150WR-I	78.7 x 59.1 in	4	330 lb	0.01	150 kg	0.005	739 lb	15,560.00
101337	IFS4-300WR-I	78.7 x 59.1 in	4	660 lb	0.02	300 kg	0.01	739 lb	15,560.00
101338	IFS4-600WR-I	78.7 x 59.1 in	4	1320 lb	0.05	600 kg	0.02	739 lb	15,560.00
101339	IFS4-1000WR-I	78.7 x 59.1 in	4	2200 lb	0.1	1000 kg	0.05	739 lb	15,560.00
101340	IFS4-1500WR-I	78.7 x 59.1 in	4	3300 lb	0.1	1500 kg	0.05	739 lb	15,560.00
101341	IFS4-3000WR-I	78.7 x 59.1 in	4	6600 lb	0.2	3000 kg	0.1	739 lb	15,560.00

## Options/Accessories

PART #	DESCRIPTION	PRICE
T4	Stop Bar	Consult
T5	Tow Bar and Stop Bar	Consult
T6	2 Handles and 2 Rollers	Consult
T7	Retractable Wheels	Consult
T9	Bottom Plate	Consult
<b>Steel</b>		
R2	316 T1 stainless steel	Consult
R6	304 2b stainless steel	Consult

www.ricelake.com | Phone: 800-472-6703

RICE LAKE

# Sartorius® Intec IS Series

## Weighing Platforms

### Standard Features

- The standard RS-485 interface is X-bus compatible. An RS-232C interface is optionally available. Power requirements range from 10.6V DC to 30V DC.
- At the touch of the unique ISO TEST key, the IS platform calibrates and adjusts itself automatically using a built-in calibration weight.
- High internal resolution guarantees reliable weight readouts.
- Weighing results: up to 50 times/second
- All scales come standard with stainless steel load plate (wrap-around design optional). High IP rating for ideal protection.

### Accessories and Options

- A complete selection of options and accessories are available, including interfaces, cables and connectors, power supplies, mechanical accessories, software and mechanical security devices.

### Specifications

**Indicator Connectivity:**

Combics UV1

**Models Sensing:**

Force Motor Cell

**Cable Length:**

9 ft

**Stability:**

Weight Stabilizes 1.5 second

**Power Requirements:**

10.6 VDC to 30VDC supplied by external power Supply, battery pack or Combics IS indicator

**Weighing Design:**

Electro magnetic

**Indicators Options:**

Combics UVI Models

**Construction:**

Stainless Steel Platforms

Die-cast or galvanized base construction (model dependent)

**Ingress Protection Rating:**

BBE/CCE: IP54

EDE: IP65

FEC/IG6: IP67

**Warranty:**

Two-year limited warranty

Accessories: one-year limited warranty



# Sartorius® Intec IS Series

Weighing Platforms

PRECISION INDUSTRIAL WEIGHING

## Part Number/Price

RLWS PN	SARTORIUS PN	PLATFORM SIZE	# LOAD CELLS	CAPACITY	READABILITY	CAPACITY	READABILITY	EST. SHIP WEIGHT	PRICE
101342	IS06BBE-S	5.1 in	1	1.3 lb	0.000002	0.62 kg	0.001 g	18 lb	\$4,065.00
101999	IS2CCE-S	8.5 x 8 in	1	4.8 lb	0.00002	2.2 kg	0.01 g	19 lb	4,055.00
102000	IS6CCE-H	8.5 x 8 in	1	13.6 lb	0.00002	6.2 kg	0.01 g	19 lb	6,115.00
102001	IS6CCE-S	8.5 x 8 in	1	13.6 lb	0.0002	6.2 kg	0.1 g	19 lb	4,275.00
102002	IS12CCE-S	8.5 x 8 in	1	26 lb	0.0002	12 kg	0.1 g	19 lb	5,405.00
102003	IS16EDE-H	15.8 x 11.8 in	1	35 lb	0.0002	16 kg	0.1 g	41 lb	4,070.00
102004	IS34EDE-H	15.8 x 11.8 in	1	75 lb	0.0002	34 kg	0.1 g	41 lb	4,995.00
102005	IS64EDE-S	15.8 x 11.8 in	1	141 lb	0.002	64 kg	1 g	41 lb	5,495.00
102006	IS64EDE-H	15.8 x 11.8 in	1	141 lb	0.0002	64 kg	0.1 g	41 lb	6,315.00
102007	IS64FEG-S	22 x 18 in	1	141 lb	0.002	64 kg	1 g	79 lb	6,305.00
102008	IS150IGG-H	32 x 24 in	1	330 lb	0.002	150 kg	1 g	185 lb	7,055.00
102009	IS300IGG-H	32 x 24 in	1	660 lb	0.005	300 kg	2 g	18 lb	7,485.00
<b>Special Order</b>									
102010	IS16EDE-H1	15.8 x 11.8 in	1	35 lb	0.00002	16 kg	0.01 g	41 lb	5,615.00
102011	IS64FEG-S1	22 x 18 in	1	141 lb	0.0002	64 kg	0.1 g	79 lb	7,435.00
102012	IS150IGG-H1	32 x 24 in	1	330 lb	0.0002	150 kg	0.1 g	185 lb	8,195.00
102013	IS300IGG-H1	32 x 24 in	1	660 lb	0.0005	300 kg	0.2 g	185 lb	8,420.00

## Options/Accessories

RLWS PN	SARTORIUS PN	DESCRIPTION	PRICE
Consult	-	Interface Mode (RS-485/422) required with Combics II indicators	Consult
32636	YRB06Z	Battery Pack, external (requires YAS0315)	\$735.00
Consult	-	DC power supply to weigh platform	Consult
Consult	YCC05_001M5	Cable, 25-Pin to 9-Pin D sub, cable for PC	Consult

## Indicators

RLWS PN	DESCRIPTION	COMMENTS	PRICE
115668	CAISL1-UV1	Combics 1 Indicator for IS Base, IP44	\$1,535.00
115670	CAISL2-UV1	Combics 2 Indicator for IS Base, IP44	1,785.00
Consult	CAISL3-UV1	Combics 3 Indicator for IS Base, IP44	Consult
115671	CAIS1-UV1	Combics 1 Indicator for IS Base, IP69K	1,745.00
115673	CAIS2-UV1	Combics 2 Indicator for IS Base, IP69K	2,035.00
115674	CAIS3-UV1	Combics 3 Indicator for IS Base, IP69K	2,405.00

www.ricelake.com | Phone: 800-472-6703

RICE LAKE

# Sartorius® Intec Signum EX Supreme

Explosion Proof Bench Scale

## Standard Features

- Monolithic weighing system
- Resolution up to 620,000 d
- Stainless steel weighing pan
- IECEX/ATEX Zone 1/2/21/22
- FM Class I, II, III; Div. 1; Groups ABCDEFG and T4
- Stainless or painted versions
- Requires YPS02-XKR (RL # 46518) hazardous area or YPS02-ZKR (RL# 46517) safe area connection
- Signum, 3 applications

## Specifications

### Material:

SIWXSBBP, SIWXSDDCP – Stainless steel display unit, Painted platform with stainless steel load plate

SIWXSBBBS, SIWXSDDCS – Brushed stainless steel

### IP Protection:

IP65

IP44 Zone 1 ONLY: SIWXSBBP, SIWXSBBBS 1.3lb (0.6kg)

### Net Weight/Gross Weight:

SIWXSBBP, SIWXSBBBS : 19.8/23.8lb (9.0/10.8kg)

SIWXSDDCP, SIWXSDDCS : 33/39.6lb (15.0/18.0kg)

### Packaging Dimensions:

SIWXSBBP, SIWXSBBBS: 22.4 x 15.7 x 14.5 in  
(570 x 400 x 370 mm)

SIWXSDDCP, SIWXSDDCS: 20 x 17.3 x 16.1 in  
(510 x 440 x 410 mm)

### Operating Temperature:

SIWXSBBP, SIWXSBBBS 50° F to 104° F (10° C to 40° C)

SIWXSDDCP, SIWXSDDCS 14° F to 104° F (-10° C to 40° C)

### Data Interfaces:

RS-232

Can be switched to RS-485 or RS-422 connection via 14-Pin round socket

### Supply Voltage:

Via external power supply, connection via 14-Pin round socket (20 cm cable)

### Power Supply Hazardous Area:

ATEX: YPSC01-X

### Power Supply Safe Area:

ATEX: YPSC01-Z

FM/CSA: YPS02-ZKR (PN 46517)

### Battery Operation:

Via external battery YRB02-X (103068)

Charger PN 103069

### Cable Length:

2 m between display unit and platform

### Warranty:

Two-year limited warranty



## APPROVALS



## Part Number/Price

RLWS PN	SARTORIUS PN	DESCRIPTION	PLATFORM DIMENSIONS	PRICE
155866	SIWXSBBP-V26*	1.3 x 0.000002lb (0.62 kg x 0.001 g)	5 in ø	\$6,310.00
155867	SIWXSBBP-V27*	6.8 x 0.00002 lb (3.1 kg x 0.01 g)	7.1 x 7.1 in	4,650.00
155868	SIWXSBBP-V28*	13.5 x 0.00002 lb (6.1 kg x 0.01 g)	7.1 x 7.1 in	5,650.00
155870	SIWXSDDCP-V29*	75 x 0.0002 lb (35 kg x 0.1 g)	13.7 x 9.7 in	5,925.00
155871	SIWXSBBBS-3-3-H	6.8 x 0.00002 lb (3.1 kg x 0.01 g)	7.1 x 7.1 in	6,485.00
155872	SIWXSBBBS-3-6-H	13.5 x 0.0002 lb (6.1 kg x 0.01 g)	7.1 x 7.1 in	7,475.00
155873	SIWXSDDCS-3-35-H	75 x 0.0002 lb (35 kg x 0.1 g)	14.5 x 10.25 in	7,370.00

\* Painted

## Options/Accessories

RLWS PN	SARTORIUS PN	DESCRIPTION	PRICE
46518	YPS02-XUR	Hazardous area power supply (8 ft. of intrinsic cable and 8 ft. of cable requiring hard wiring by licensed electrician)	\$2,010.00
46517	YPS02-ZKR	Safe area power supply (65 ft of intrinsically safe cable)	2,010.00
103055	YD105-ZU2	Zener Barrier hazardous area RS-232 to RS-232 converter, 14-Pin plug	950.00
103059	YD105-ZU3	Zener Barrier hazardous area RS-422 to RS-232 (requires 6971413, RL 50232, power supply) cable connection not included	745.00
153218	YDH01PUS	Column for DC platforms, height 19 in	295.00
155884	YDH02P	Column for BBP platforms, height 15.75 in	475.00
105607	YDH02C1SUS	Wall mount bracket	105.00
103068	YRB02-X	Rechargeable battery (requires 103069 battery charger)	1,595.00
103069	YRB02-LD	Battery charger (requires power cord)	370.00
103057	YCC422-Y	Cable with out connectors for RS-422	17.00/ft
102078	6971954	Power cord	45.00

# Sartorius® Intec Combics 2 EX

Explosion Proof Digital Weight Indicators

## Standard Features

- Amber backlit LCD dot matrix display
- On/Off, Zero, Tare, and Print/Data Keys
- Function keys for: Gross/net toggle; three-way unit toggle; 10X higher resolution toggle
- Two header line storage
- Battery charge status display (with connection of battery pack)
- Numeric keypad with two "ID" for entering identifier codes and preset tare
- Date/time fully integrated
- GMP printable record
- Three built-in LED checkweighing lights
- Bar graph weighing range indicator
- Application data and totalization memory stored in battery-backed RAM
- Optional barcode scanner for preset tare, reference weight and ID entry
- Requires power supply



### Applications Software Pre-Installed

Counting, checkweighing, differential weighing, percentage weighing, gross-net-tare, sorting, net-total, animal weighing.

Ex approval: FM Class 1,2,3, Division 1, Groups ABCDEFG and temperature class T4.

Weighbridge connectivity – maximum two precision weighing platforms or load cells, and one precision platform or 1 Combics Ex and one precision platform.

Power Supply can be provided by 110-220VAC connections and a 24VDC industrial power module (each suitable for hazardous and safe areas) and a rechargeable battery pack in stainless steel casing.

## Specifications

### Load Cell:

4 or 6 wire

### Supply Voltage:

6V

### Housing:

304 stainless steel

### Ingress Protection Rating:

IP69K/NEMA 4X

### Dimensions:

11.9 W x 7.4 D x 3.5 in H  
302.3 W x 188 D x 89 mm H

### Operating Temperature:

14° F to 104° F (-10° C to 40° C)

### Warranty:

Two-year limited warranty  
Accessories: one-year limited warranty

### Approvals:

FM approved

## APPROVALS



## Part Number/Price

RLWS PN	SARTORIUS PN	DESCRIPTION	EST. SHIP WEIGHT	PRICE
158644	CAIXS2-U	IP69K Protection rated	7 lb	\$2,150.00

\*IS power supply or battery pack required

## Options/Accessories

RLWS PN	SARTORIUS PN	DESCRIPTION	PRICE
46518	YPS02-XKR	Power supply, hazardous area	\$2,010.00
46517	YPS02-ZKR	Power supply, safe area, 65 ft cable	1,705.00
103068	YRB02-X	Battery pack, 30+ hours (requires 103069)	1,595.00
103069	YBR02-LD	Charger for battery pack	370.00
103054	YCC02-XR14F02	Quick disconnect cable, for Zener Barrier	260.00
155882	YD105-ZU1	Zener Barrier, requires 103054	950.00
155918	A19	485 interface (IS-X Base)	180.00
155919	M26	Cable to IS-X	255.00

# Sartorius® Intec Combics

Explosion Proof Bench and Floor Platforms

## Standard Features

- FM Approved: Classes 1,2,3, Division 1, Groups ABCDEGFT4, US and Canadian hazardous areas, when used with CIX53-U
- Can be used in areas where explosive gas and dust mixtures occur
- Documentation to verify intrinsic safety available upon request
- Completely constructed with AISI 304 stainless steel
- All units are built for easy cleaning and disinfection and meet HACCP and FDA requirements for the food industry.
- Load cells are hermetically sealed, IP68 protection rated
- Load cell cables are 10 ft (for bases up to 30 in x 30 in) or 20 ft (for bases 36 in x 36 in and larger)
- NEMA4/IP67 protection rated
- Pit frames for flush mounting available
- High resolution 30,000 d

## Applications

- Pharmaceutical, chemical, electronics, food processing, precious metals, metal production and processing
- Regulatory Compliance
- NEMA, HACCP, FDA, GLP/GMP\*, FM

## Specifications

### Cable Length:

Up to 30 x 30 - 10 ft  
36 x 36 and over - 20 ft

### Operating Temperature:

14° F to 104° F

### Ingress Protection Rating:

NEMA 4/IP67

### Indicator Option:

CIXS3-U

### Warranty:

Two-year limited warranty  
Accessories: one-year limited warranty

### Approvals:

FM approved Classes 1,2,3, Division 1, Groups ABCDEGFT4, US and Canadian hazardous areas, when used with CIXS3-U or FCT01-X indicator



*\*GLP/GMP requires use of Combics 1 Plus or higher digital weight indicator*

## APPROVALS



# Sartorius® Intec Combics

Explosion Proof Bench and Floor Platforms

## Part Number/Price

RLWS PN	SARTORIUS PN	DIMENSIONS	HEIGHT ADJUSTMENT	# LOAD CELLS	CAPACITY	READABILITY	CAPACITY	READABILITY	EST. SHIP WEIGHT	PRICE
100919	CAPXS1U-10CC	10 x 10 in	2.37 in	1	15 lb	0.0005	6 kg	0.0002	16 lb	\$1,040.00
100920	CAPXS1U-20CC	10 x 10 in	2.37 in	1	30 lb	0.001	15 kg	0.0005	16 lb	1,040.00
100921	CAPXS1U-50CC	10 x 10 in	2.37 in	1	60 lb	0.002	30 kg	0.001	16 lb	1,040.00
100922	CAPXS1U-50DD	12 x 12 in	3.87 in		60 lb	0.002	30 kg	0.001	24 lb	1,165.00
100923	CAPXS1U-100DD	12 x 12 in	3.87 in	1	150 lb	0.005	60 kg	0.002	24 lb	1,165.00
100924	CAPXS1U-50EE	18 x 18 in	3.5 in	1	60 lb	0.002	30 kg	0.001	62 lb	1,435.00
100925	CAPXS1U-100EE	18 x 18 in	3.5 in	1	150 lb	0.005	60 kg	0.002	62 lb	1,435.00
100926	CAPXS1U-200EE	18 x 18 in	3.5 in	1	200 lb	0.01	100 kg	0.005	62 lb	1,435.00
100934	CAPXS4U-250GG	24 x 24 in	3.31 in	4	300 lb	0.01	150 kg	0.005	12 lb	4,225.00
100935	CAPXS4U-500GG	24 x 24 in	3.31 in	4	600 lb	0.02	300 kg	0.01	12 lb	4,225.00
100943	CAPXS4U-500HH	30 x 30 in	3.31 in	4	600 lb	0.02	300 kg	0.01	187 lb	4,665.00
100944	CAPXS4U-1000HH	30 x 30 in	3.31 in	4	1500 lb	0.05	600 kg	0.02	187 lb	4,665.00
100945	CAPXS4U-1000KK	36 x 36 in	3.75 in	4	1500 lb	0.05	600 kg	0.02	250 lb	4,450.00
100946	CAPXS4U-2500KK	36 x 36 in	3.75 in	4	3000 lb	0.1	1500 kg	0.05	250 lb	4,450.00
100947	CAPXS4U-5000KK	36 x 36 in	3.75 in	4	6000 lb	0.2	3000 kg	0.1	250 lb	4,450.00
100949	CAPXS4U-2500NN	48 x 48 in	3.75 in	4	3000 lb	0.1	1500 kg	0.05	390 lb	5,250.00
100950	CAPXS4U-5000NN	48 x 48 in	3.75 in	4	6000 lb	0.2	3000 kg	0.1	390 lb	5,250.00



# Sartorius® Intec IF Series

Explosion Proof Weighing Platforms

## Standard Features

- Capacities from 150 to 3000 kg with resolutions up to 30,000 dd
- Ultra low profile: standard platform height is 35 mm; optional heights available as low as 25 mm
- Material/surface finish: 304 bead-blasted stainless steel
- Drive-on ramp included with every platform
- No pit required
- Convenient for application-oriented weighing systems from processing to the chemical industry
- Standard configuration: AISI 304 stainless steel

## Optional Configurations

- Electro-polished finish
- AISI 304 electro-polished stainless steel platform
- AISI 316Ti electro-polished stainless steel platform
- Ingenious manually operated lifting mechanism option (patented system) for effortless raising of the platform For it easy-to-clean under the platform at the place of installation.
- R2: Cold rolled AISI 316Ti stainless steel, electro-polished
- R6: AISI 304 2b stainless steel, electro-polished
- T4: Stop bar
- T5: Tow bar and stop bar
- T6: Two handles and two rollers
- T7: Retractable wheels (reduces effective resolution to 15,000 dd)
- T9: Additional bottom plate
- T15: 2nd ramp
- T14: Integrated column
- T13: Four handles

## Applications

- Pharmaceutical, chemical, electronics, food processing, precious metals, metal production and processing

## Specifications

**Ingress Protection Rating:**  
IP68

**Load Cells:**  
Four hermetically sealed IP68

**Cable Length:**  
19.7 ft (6 m)

**Regulatory Compliance:**  
HACCP, FDA, Class 10,000 clean rooms  
(US Federal Standard 209D)

**Warranty:**  
Two year limited warranty

**Approvals:**  
FM approved, IFXS4 series, are certified for use in Class 1,2,3, Div. 1, Groups ABCDEFT4 (Verification of Intrinsic Safety included; also covers any explosion-protected Sartorius components combined with this platform series)



Optional Handles



### Regulatory Compliance

NEMA, HACCP, FDA, GLP/GMP\*, Class 10,000 Clean Rooms  
(US Federal Standard 209D)

(Equivalent to Class C in accordance with EEC-GWP), FM

\*GLP/GMP requires use of Combiics 1 Plus or higher digital weight indicator

## APPROVALS



# Sartorius® Intec IF Series

Explosion Proof Weighing Platforms

## Part Number/Price

RLWS PN	SARTORIUS PN	DIMENSIONS	# LOAD CELLS	CAPACITY	READABILITY	CAPACITY	READABILITY	EST. SHIP WEIGHT	PRICE
102530	IFXS4-150GG-I	23.6 x 23.6 in	4	330 lb	0.01	150 kg	0.005	198 lb	\$11,570.00
102531	IFXS4-300GG-I	23.6 x 23.6 in	4	660 lb	0.02	300 kg	0.01	198 lb	11,570.00
102532	IFXS4-600GG-I	23.6 x 23.6 in	4	1320 lb	0.05	600 kg	0.02	198 lb	11,570.00
102533	IFXS4-1000GG-I	23.6 x 23.6 in	4	2200 lb	0.1	1000 kg	0.05	198 lb	11,570.00
102534	IFXS4-150IG-I	31.5 x 23.6 in	4	330 lb	0.01	150 kg	0.005	221 lb	11,625.00
102536	IFXS4-300IG-I	31.5 x 23.6 in	4	660 lb	0.02	300 kg	0.01	221 lb	11,625.00
102537	IFXS4-600IG-I	31.5 x 23.6 in	4	1320 lb	0.05	600 kg	0.02	221 lb	11,625.00
102538	IFXS4-1000IG-I	31.5 x 23.6 in	4	2200 lb	0.1	1000 kg	0.05	221 lb	11,625.00
102540	IFXS4-150II-I	31.5 x 31.5 in	4	330 lb	0.01	150 kg	0.005	243 lb	11,920.00
102541	IFXS4-300II-I	31.5 x 31.5 in	4	660 lb	0.02	300 kg	0.01	243 lb	11,920.00
102542	IFXS4-600II-I	31.5 x 31.5 in	4	1320 lb	0.05	600 kg	0.02	243 lb	11,920.00
102543	IFXS4-1000II-I	31.5 x 31.5 in	4	2200 lb	0.1	1000 kg	0.05	243 lb	11,920.00
102544	IFXS4-1500II-I	31.5 x 31.5 in	4	3300 lb	0.1	1500 kg	0.05	243 lb	11,920.00
102545	IFXS4-150LG-I	39.4 x 23.6 in	4	330 lb	0.01	150 kg	0.005	243 lb	12,035.00
102546	IFXS4-300LG-I	39.4 x 23.6 in	4	660 lb	0.02	300 kg	0.01	243 lb	12,035.00
102547	IFXS4-600LG-I	39.4 x 23.6 in	4	1320 lb	0.05	600 kg	0.02	243 lb	12,035.00
102548	IFXS4-1000LG-I	39.4 x 23.6 in	4	2200 lb	0.1	1000 kg	0.05	243 lb	12,035.00
102549	IFXS4-1500LG-I	39.4 x 23.6 in	4	3300 lb	0.1	1500 kg	0.05	243 lb	12,035.00
102550	IFXS4-150LI-I	39.4 x 31.5 in	4	330 lb	0.01	150 kg	0.005	265 lb	12,385.00
102551	IFXS4-300LI-I	39.4 x 31.5 in	4	660 lb	0.02	300 kg	0.01	265 lb	12,385.00
102552	IFXS4-600LI-I	39.4 x 31.5 in	4	1320 lb	0.05	600 kg	0.02	265 lb	12,385.00
102553	IFXS4-1000LI-I	39.4 x 31.5 in	4	2200 lb	0.1	1000 kg	0.05	265 lb	12,385.00
102554	IFXS4-1500LI-I	39.4 x 31.5 in	4	3300 lb	0.1	1500 kg	0.05	265 lb	12,385.00
102555	IFXS4-150LL-I	39.4 x 39.4 in	4	330 lb	0.01	150 kg	0.005	375 lb	13,085.00
102556	IFXS4-300LL-I	39.4 x 39.4 in	4	660 lb	0.02	300 kg	0.01	375 lb	13,085.00
102557	IFXS4-600LL-I	39.4 x 39.4 in	4	1320 lb	0.05	600 kg	0.02	375 lb	13,085.00
102558	IFXS4-1000LL-I	39.4 x 39.4 in	4	2200 lb	0.1	1000 kg	0.05	375 lb	13,440.00
102559	IFXS4-1500LL-I	39.4 x 39.4 in	4	3300 lb	0.1	1500 kg	0.05	375 lb	13,085.00
102560	IFXS4-3000LL-I	39.4 x 39.4 in	4	6600 lb	0.2	3000 kg	0.1	375 lb	13,085.00
102561	IFXS4-150NL-I	49.2 x 39.4 in	4	330 lb	0.01	150 kg	0.005	397 lb	13,440.00
102562	IFXS4-300NL-I	49.2 x 39.4 in	4	660 lb	0.02	300 kg	0.01	397 lb	13,440.00
102563	IFXS4-600NL-I	49.2 x 39.4 in	4	1320 lb	0.05	600 kg	0.02	397 lb	13,440.00
102564	IFXS4-1000NL-I	49.2 x 39.4 in	4	2200 lb	0.1	1000 kg	0.05	397 lb	13,440.00
102565	IFXS4-1500NL-I	49.2 x 39.4 in	4	3300 lb	0.1	1500 kg	0.05	397 lb	13,440.00
102566	IFXS4-3000NL-I	49.2 x 39.4 in	4	6600 lb	0.2	3000 kg	0.1	397 lb	13,440.00
102567	IFXS4-150NN-I	49.2 x 49.2 in	4	330 lb	0.01	150 kg	0.005	481 lb	14,025.00
102568	IFXS4-300NN-I	49.2 x 49.2 in	4	660 lb	0.02	300 kg	0.01	481 lb	14,025.00
102569	IFXS4-600NN-I	49.2 x 49.2 in	4	1320 lb	0.05	600 kg	0.02	481 lb	14,025.00
102570	IFXS4-1000NN-I	49.2 x 49.2 in	4	2200 lb	0.1	1000 kg	0.05	481 lb	14,025.00
102571	IFXS4-1500NN-I	49.2 x 49.2 in	4	3300 lb	0.1	1500 kg	0.05	481 lb	14,025.00
102572	IFXS4-3000NN-I	49.2 x 49.2 in	4	6600 lb	0.2	3000 kg	0.1	481 lb	14,025.00
102573	IFXS4-150RN-I	59.1 x 49.2 in	4	330 lb	0.01	150 kg	0.005	547 lb	14,725.00
102574	IFXS4-300RN-I	59.1 x 49.2 in	4	660 lb	0.02	300 kg	0.01	547 lb	14,725.00
102575	IFXS4-600RN-I	59.1 x 49.2 in	4	1320 lb	0.05	600 kg	0.02	547 lb	14,725.00
102576	IFXS4-1000RN-I	59.1 x 49.2 in	4	2200 lb	0.1	1000 kg	0.05	547 lb	14,725.00
102577	IFXS4-1500RN-I	59.1 x 49.2 in	4	3300 lb	0.1	1500 kg	0.05	547 lb	14,725.00

# Sartorius® Intec IF Series

Explosion Proof Weighing Platforms

## Part Number/Price

RLWS PN	SARTORIUS PN	DIMENSIONS	# LOAD CELLS	CAPACITY	READABILITY	CAPACITY	READABILITY	EST. SHIP WEIGHT	PRICE
102578	IFXS4-3000RN-I	59.1 x 59.1 in	4	6600 lb	0.2	3000 kg	0.1	547 lb	\$14,725.00
102579	IFXS4-150RR-I	59.1 x 59.1 in	4	330 lb	0.01	150 kg	0.005	628 lb	14,985.00
102580	IFXS4-300RR-I	59.1 x 59.1 in	4	660 lb	0.02	300 kg	0.01	628 lb	14,985.00
102581	IFXS4-600RR-I	59.1 x 59.1 in	4	1320 lb	0.05	600 kg	0.02	628 lb	14,985.00
102582	IFXS4-1000RR-I	59.1 x 59.1 in	4	2200 lb	0.1	1000 kg	0.05	628 lb	14,985.00
102583	IFXS4-1500RR-I	59.1 x 59.1 in	4	3300 lb	0.1	1500 kg	0.05	628 lb	14,985.00
102584	IFXS4-3000RR-I	59.1 x 59.1 in	4	6600 lb	0.2	3000 kg	0.1	628 lb	14,985.00
102585	IFXS4-150WR-I	78.7 x 59.1 in	4	330 lb	0.01	150 kg	0.005	739 lb	15,545.00
102586	IFXS4-300WR-I	78.7 x 59.1 in	4	660 lb	0.02	300 kg	0.01	739 lb	15,545.00
102587	IFXS4-600WR-I	78.7 x 59.1 in	4	1320 lb	0.05	600 kg	0.02	739 lb	15,545.00
102588	IFXS4-1000WR-I	78.7 x 59.1 in	4	2200 lb	0.1	1000 kg	0.05	739 lb	15,545.00
102589	IFXS4-1500WR-I	78.7 x 59.1 in	4	3300 lb	0.1	1500 kg	0.05	739 lb	15,545.00
102590	IFXS4-3000WR-I	78.7 x 59.1 in	4	6600 lb	0.2	3000 kg	0.1	739 lb	15,545.00

## Options/Accessories - Not Available On All Models

PART #	DESCRIPTION	PRICE
T4	Stop bar	Consult
T5	Tow bar and stop bar	Consult
T6	Two handles and two rollers	Consult
T7	Retractable wheels	Consult
T9	Bottom plate	Consult
T13	Four handles	Consult
T14	Integrated Column	Consult
T15	2nd ramp	Consult
<b>Steel</b>		
R2	316 stainless steel	Consult
R6	304 stainless steel	Consult

# Sartorius® Intec IS-X

Explosion Proof Scales

## Standard Features

- Networkable: RS-485 interface is X-bus compatible
- Built-in Internal Calibration function: at the touch of the unique ISO TEST Key, the IS platform calibrates and adjusts itself automatically using a built-in calibration weight
- High resolution: guarantees reliable weight readouts
- Fast weighing results: up to 50 times/second
- Stainless steel load plate: all scales come standard with stainless steel load plate
- High IP Rating for ideal protection

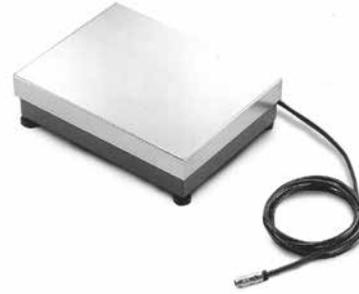

## Specifications

### Indicator Connectivity:

Combics CIXS3 with option

### Weighing Design:

Electro magnetic

### Cable Length:

9 ft

### Stability:

Weight stabilizes 1.5 second

### Interface:

RS-485 standard

### Power Requirements:

Requires YPS02-XXR (46518) hazardous area power supply or YPS02-ZKR (46517) safe area power supply

### Construction:

Stainless steel platform, die cast or galvanized base construction (model dependent)

### Ingress Protection:

CCE: IP54  
EDE: IP65  
IGG: IP67

### Warranty:

Two-year limited warranty; accessories one year

### Sample Order Configuration:

1. Select Base
2. Select Two Power Supplies – base and indicator

158644 CAIXS2

155918 A19 485 interface

155919 M26 Cable to IS-X

## Part Number/Price

RLWS PN	SARTORIUS PN	DESCRIPTION	PAN SIZE	PRICE
155874	IS2CCE-SX	4.8 x 0.00002 lb (2.2 kg x 0.01 g)	8.5 x 8 in	\$4,270.00
155875	IS6CCE-HX	13.5 x 0.00002 lb (6.1 kg x 0.01 g)	8.5 x 8 in	4,465.00
155876	IS12CCE-SX	26 x 0.0002 lb (12 kg x 0.1 g)	15.8 x 11.8 in	4,695.00
155877	IS16EDE-HX	35 x 0.0002 lb (16 kg x 0.1 g)	15.8 x 11.8 in	4,715.00
155878	IS34EDE-HX	75 x 0.0002 lb (34 kg x 1 g)	15.8 x 11.8 in	4,975.00
155879	IS64EDE-SX	141 x 0.002 lb (64 kg x 1 g)	15.8 x 11.8 in	5,855.00
156371	IS64EDE-HX	141 x 0.0002 lb (64 kg x 0.1 g)	15.8 x 11.8 in	7,535.00
155880	IS150IGG-HX	330 x 0.002 lb (150 kg x 1 g)	22 x 18 in	6,755.00
155881	IS300IGG-HX	660 x 0.005 lb (300 kg x 2 g)	22 x 18 in	6,995.00

## Options/Accessories

RLWS PN	SARTORIUS PN	DESCRIPTION	PRICE
<b>Power Supply Required (one for base and one for indicator)</b>			
46518	YPS02-XXR	Hazardous area power supply	\$2,010.00
46517	YPS02-ZKR	Safe area power supply	2,010.00
<b>Indicator and Options Required</b>			
158644	CAIXS2	Combics EX (requires 155918 and 155919)	2,150.00
155918	A19	485 Interface	330.00
155919	M26	Cable to IS-X	255.00
155882	YD105-ZU1	Zener Barrier, RS-232, 20m cable open end	950.00
103059	YD105-ZU3	Zener Barrier, RS-422, RS-232 (requires 6971413 RL# 50232 power supply) cable connection not included	745.00

# Sartorius® Intec PR6201

Zinc-Plated Steel Star Mount Kits

## Standard Features

- Fast and easy installation
- Mounting kit with dummy function included
- Designed to withstand high lateral forces
- Maintenance free constrainer and module construction
- Patent pending DE 101 38 435A1
- Approval Certificate "Germanischer Lloyd" No. 47-458-03HH
- Load cell output 1 mV/V
- 15 year load cell warranty
- 10,000 division load cell
- 45 kN zinc-plated mount destructive lateral force; 20 kN permissible lift-off protection
- Foot 20 kN lateral force and lift-off protection

## Load Cell Certifications



Junction Box not shown

The PR6201 mounting kit family is optimized for the PR 6201 load cell family to guarantee best weighing performance. It covers the capacity range from 500 kg up to 300t. The special design allows a horizontal displacement in the unconstrained direction of the load cell. All constrainters are 100% maintenance free. There are two different materials available: stainless steel or mild steel zinc plated. Its unique design includes a dummy functionality to install the vessel without load cell. The top load disc remains in place even when the load cell is not mounted. The design principle integrates a lift-off protection and built-in stops.

## Zinc-Plated Steel Options

TOTAL CAPACITY		LOAD CELL CAPACITY		RL PART #	SARTORIUS PART #	PRICE
<b>3-Module Kit</b>						
3,300 lb	1,500 kg	1,100 lb	500 kg	158706	PR6201-1531-U	\$7,580.50
6,600 lb	3,000 kg	2,200 lb	1,000 kg	158708	PR6201-3031-U	7,580.50
13,200 lb	6,000 kg	4,400 lb	2,000 kg	158710	PR6201-6031-U	7,580.50
19,800 lb	9,000 kg	6,600 lb	3,000 kg	158712	PR6201-9031-U	7,580.50
33,000 lb	15,000 kg	11,025 lb	5,000 kg	158716	PR6201-15031-U	7,580.50
66,000 lb	30,000 kg	22,050 lb	10,000 kg	158719	PR6201-30031-U	7,580.50
132,000 lb	60,000 kg	44,100 lb	20,000 kg	158721	PR6201-60031-U	7,760.50
198,000 lb	90,000 kg	66,140 lb	30,000 kg	158723	PR6201-90031-U	7,898.50
330,500 lb	150,000 kg	110,200 lb	50,000 kg	158725	PR6201-150031-U	8,516.50
<b>4-Module Kit</b>						
4,400 lb	2,000 kg	1,100 lb	500 kg	158707	PR6201-2041-U	9,480.50
8,800 lb	4,000 kg	2,200 lb	1,000 kg	158709	PR6201-4041-U	9,480.50
17,600 lb	8,000 kg	4,400 lb	2,000 kg	158711	PR6201-8041-U	9,480.50
26,400 lb	12,000 kg	6,600 lb	3,000 kg	158713	PR6201-12041-U	9,480.50
44,000 lb	20,000 kg	11,025 lb	5,000 kg	158718	PR6201-20041-U	9,480.50
88,000 lb	40,000 kg	22,050 lb	10,000 kg	158720	PR6201-40041-U	9,480.50
176,000 lb	80,000 kg	44,100 lb	20,000 kg	158722	PR6201-80041-U	9,720.50
264,500 lb	120,000 kg	66,140 lb	30,000 kg	158724	PR6201-120041-U	9,904.50
440,500 lb	200,000 kg	110,200 lb	50,000 kg	158726	PR6201-200041-U	10,728.50

Complete Kit Includes:

PR6201 load cell, PR6001/10 (11) mount, junction box, load cell extension cable; 4-mount kit includes PR6001/00 or (01) N foot

# Sartorius® Intec PR6201

Stainless Steel Star Mount Kits

## Standard Features

- Fast and easy installation
- Mounting kit with dummy function included
- PR 6201 load cell for capacities ranging from 500 kg to 300 t
- Designed to withstand high lateral forces
- Maintenance free constrainer and module construction
- Patent pending DE 101 38 435A1
- Approval Certificate "Germanischer Lloyd" No. 47-458-03HH
- Load cell output 1 mV/V
- 15 year load cell warranty
- 10,000 division load cell
- 39kN stainless steel mount destructive lateral force; 20 kN permissible lift-off protection
- Foot 20 kN lateral force and lift-off protection

## Load Cell Certifications



Junction Box not shown

The PR6201 mounting kit family is optimized for the PR 6201 load cell family to guarantee best weighing performance. It covers the capacity range from 500 kg up to 300 t. The special design allows a horizontal displacement in the unconstrained direction of the load cell. All constrainers are 100% maintenance free. There are two different materials available: stainless steel or mild steel zinc plated. Its unique design includes a dummy functionality to install the vessel without load cell. The top load disc remains in place even when the load cell is not mounted. The design principle integrates a lift-off protection and built-in stops.

## Stainless Steel Options

TOTAL CAPACITY		LOAD CELL CAPACITY		RL PART #	SARTORIUS PART #	PRICE
<b>3-Module Kit</b>						
3,300 lb	1,500 kg	1,100 lb	500 kg	158727	PR6201-1532-U	\$9,047.50
6,600 lb	3,000 kg	2,200 lb	1,000 kg	158788	PR6201-3032-U	9,047.50
13,200 lb	6,000 kg	4,400 lb	2,000 kg	158731	PR6201-6032-U	9,047.50
19,800 lb	9,000 kg	6,600 lb	3,000 kg	158733	PR6201-9032-U	9,047.50
33,000 lb	15,000 kg	11,025 lb	5,000 kg	158735	PR6201-15032-U	9,047.50
66,000 lb	30,000 kg	22,050 lb	10,000 kg	158737	PR6201-30032-U	9,047.50
132,000 lb	60,000 kg	44,100 lb	20,000 kg	158739	PR6201-60032-U	9,227.50
198,000 lb	90,000 kg	66,140 lb	30,000 kg	158741	PR6201-90032-U	9,365.50
330,500 lb	150,000 kg	110,200 lb	50,000 kg	158743	PR6201-150032-U	9,983.50
<b>4-Module Kit</b>						
4,400 lb	2,000 kg	1,100 lb	500 kg	158729	PR6201-2042-U	11,287.50
8,800 lb	4,000 kg	2,200 lb	1,000 kg	158730	PR6201-4042-U	11,287.50
17,600 lb	8,000 kg	4,400 lb	2,000 kg	158732	PR6201-8042-U	11,287.50
26,400 lb	12,000 kg	6,600 lb	3,000 kg	158734	PR6201-12042-U	11,287.50
44,000 lb	20,000 kg	11,025 lb	5,000 kg	158736	PR6201-20042-U	11,287.50
88,000 lb	40,000 kg	22,050 lb	10,000 kg	158738	PR6201-40042-U	11,287.50
176,000 lb	80,000 kg	44,100 lb	20,000 kg	158740	PR6201-80042-U	11,527.50
264,500 lb	120,000 kg	66,140 lb	30,000 kg	158742	PR6201-120042-U	11,711.50
440,500 lb	200,000 kg	110,200 lb	50,000 kg	158744	PR6201-200042-U	12,535.50

Complete Kit Includes:

PR6201 load cell, PR6001/10 (11) mount, junction box, load cell extension cable; 4-mount kit includes PR6001/00 or (01) N foot

# Sartorius® Intec PR6202

Hygienic Weigh Module Kits

## Standard Features

- Proven rocker-pin principle for accurate repeatability
- Easy corner adjustment by matched load cell output
- All stainless steel construction
- Wide operating temperature range
- High overload capacity
- Resists vibration for consistent high accuracy
- Hermetically sealed, IP68/69K (depth of 1.5 m for 10,000 hours)
- EX-version available (PR 6202/.E)
- 10,000 division load cell, 2 mV/V
- 15 year warranty
- 50 kN destructive lateral force, and 25 kN permissible lift-off protection
- Foot 35 kN lateral force and lift-off protection



## Load Cell Certifications



The PR6202 range of load cells is specially designed to meet the high demands of the food, pharmaceutical and chemical industries. These products are made completely from stainless steel and are specially designed for use with process vessels. All horizontal surfaces are inclined for easy draining, and gaps and undercuts have purposely been avoided. The materials and surface quality were also selected to ensure the load cell meets tried and tested international standards and specifications. Its unique design principle enables it to compensate for motions caused by mechanical/thermal contractions or expansions of containers and/or padding construction in combination with its mounting kit, which has been specially designed for this area of application. The PR6202 is designed for consistent, high accuracy.

## Zinc-Plated Steel Options

TOTAL CAPACITY		LOAD CELL CAPACITY		RL PART #	SARTORIUS PART #	PRICE
<b>3-Module Kit</b>						
6,600 lb	3,000 kg	2,200 lb	1,000 kg	158761	PR6202-3032-U	\$10,823.50
13,200 lb	6,000 kg	4,400 lb	2,000 kg	158764	PR6202-6032-U	10,823.50
26,000 lb	12,000 kg	8,820 lb	4,000 kg	158767	PR6202-12032-U	11,117.50
39,500 lb	18,000 kg	13,230 lb	6,000 kg	158770	PR6202-18032-U	11,117.50
66,000 lb	30,000 kg	22,050 lb	10,000 kg	158772	PR6202-30032-U	11,117.50
165,000 lb	75,000 kg	55,120 lb	25,000 kg	158929	PR6202-75032-U	11,411.50
330,500 lb	150,000 kg	110,230 lb	50,000 kg	158775	PR6202-150032-U	12,986.50
<b>4-Module Kit</b>						
8,800 lb	4,000 kg	2,200 lb	1,000 kg	158762	PR6202-4042-U	13,459.50
17,600 lb	8,000 kg	4,400 lb	2,000 kg	158765	PR6202-8042-U	13,459.50
35,000 lb	16,000 kg	8,820 lb	4,000 kg	158769	PR6202-16042-U	13,851.50
52,900 lb	24,000 kg	13,230 lb	6,000 kg	158771	PR6202-24042-U	13,851.50
88,000 lb	40,000 kg	22,050 lb	10,000 kg	158773	PR6202-40042-U	13,851.50
220,000 lb	100,000 kg	55,120 lb	25,000 kg	158774	PR6202-100042-U	14,243.50
440,500 lb	200,000 kg	110,230 lb	50,000 kg	158776	PR6202-200042-U	16,343.50

Complete Kit Includes:

PR6202 load cell, PR6002/10S (11S) mount, junction box, load cell extension cable; 4-mount kit includes PR6002/04S or (05S) foot

# Sartorius® Intec Contego-Hygienic Weigh Module Kits

Lateral Cable Outlet

## Standard Features

- Compact and absolute hygienic weighing solution for a load range up to 2t
- Quick and seamless installation
- Easy cleaning without residue High chemical resistance
- Protective cover made of FDA-compliant silicone
- Integrated S-like lift-off protector and jack-up function with constrainer for horizontal forces
- Proven rocker pin principle for accurate repeatability
- 10,000 divisions
- Load cell, 2 mV/V
- 15 year load cell warranty
- 30 kN destructive lateral force and 8 kN permissible lift-off protection

## Load Cell Certifications

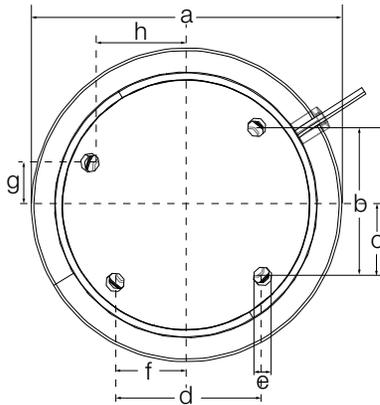

## Dimensions

RATED CAPACITY	A	B	C	D	E	F	G	H
in/mm								
Lateral Cable	8.3 in (210 mm)	3.7 in (94 mm)	1.9 in (47 mm)	3.7 in (94 mm)	0.5 in (12 mm)	1.9 in (47 mm)	1.1 in (29 mm)	2.4 in (60 mm)

## Lateral Cable Outlet Options

TOTAL CAPACITY	LOAD CELL CAPACITY	RL PART #	SARTORIUS PART #	PRICE
<b>3-Module Kit</b>				
660 lb	300 kg	220 lb	100 kg	158832
1,300 lb	600 kg	440 lb	200 kg	158834
1,900 lb	900 kg	660 lb	300 kg	158892
3,300 lb	1500 kg	1,100 lb	500 kg	158837
6,600 lb	3000 kg	2,200 lb	1,000 kg	158839
13,200 lb	6,000 kg	4,400 lb	2,000 kg	158841
<b>4-Module Kit</b>				
880 lb	400 kg	220 lb	100 kg	158833
1,700 lb	800 kg	440 lb	200 kg	158835
2,500 lb	1200 kg	660 lb	300 kg	158836
4,400 lb	2000 kg	1,100 lb	500 kg	158838
8,800 lb	4000 kg	2,200 lb	1,000 kg	158840
17,600 lb	8000 kg	4,400 lb	2,000 kg	158842

Complete Kit Includes:  
Contega load cell, junction box, load cell extension cable



Junction Box not shown

The protective cover made of FDA-compliant silicone ensures a reliable encapsulation of the module and prevents the intrusion of dirt and microorganisms. The connecting geometry between protective cover and mounting plates guarantees a safe fitting and, together with the already excellent resistance to aging of the silicone, ensures reliable protection over years.

The Contego® weighing module therefore represents an absolutely hygienic unity of load cell and installation kit. As a result, you can refrain from using other expensive and complicated constructions to protect the weighing technology against dirt.

Besides the hygienic aspect, the Contego weighing module provides all the other important mechatronic functions for a fast operational startup and reliable results. The integrated constraint holds the process vessel in the proper position and, at the same time, allows movement through thermal expansion of the vessel. The integrated lift-off protector is a reliable safety feature to protect the vessel from tilting. At the same time, this feature can be used as a lifting system as well. This way, the vessel leg can be raised a few millimeters without using supplemental tools.

A PR6241 S-type load cell is used with this module. This series is distinguished by its unmatched reliability, robustness and stability, enabling years of undisturbed usage without any readjustment, in addition to the high measuring accuracy and reproducibility.

## Options/Accessories

PART #	TYPE	SARTORIUS PART #	DESCRIPTION	PRICE
160438	PR6041/80S	9405 360 41802	Top plate, tank leg connection	\$360.00



# Sartorius® Intec Contego-Hygienic Weigh Module Kits

Top Cable Outlet

## Standard Features

- Compact and absolute hygienic weighing solution for a load range up to 2 t
- Quick and seamless installation
- Easy cleaning without residue High chemical resistance
- Protective cover made of FDA-compliant silicone
- Integrated S-like lift-off protector and jack-up function with constrainer for horizontal forces
- Proven rocker pin principle for accurate repeatability
- 10,000 divisions
- Load cell, 2 mV/V
- 15 year load cell warranty
- 30 kN destructive lateral force and 8 kN permissible lift-off protection

## Load Cell Certifications

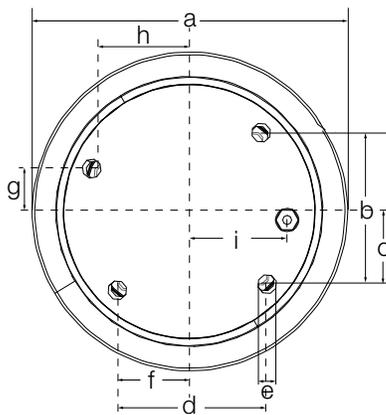

Junction Box not shown

The protective cover made of FDA-compliant silicone ensures a reliable encapsulation of the module and prevents the intrusion of dirt and microorganisms. The connecting geometry between protective cover and mounting plates guarantees a safe fitting and, together with the already excellent resistance to aging of the silicone, ensures reliable protection over years.

The Contego® weighing module therefore represents an absolutely hygienic unity of load cell and installation kit. As a result, you can refrain from using other expensive and complicated constructions to protect the weighing technology against dirt.

Besides the hygienic aspect, the Contego weighing module provides all the other important mechatronic functions for a fast operational startup and reliable results. The integrated constraint holds the process vessel in the proper position and, at the same time, allows movement through thermal expansion of the vessel. The integrated lift-off protector is a reliable safety feature to protect the vessel from tilting. At the same time, this feature can be used as a lifting system as well. This way, the vessel leg can be raised a few millimeters without using supplemental tools.

A PR6241 S-type load cell is used with this module. This series is distinguished by its unmatched reliability, robustness and stability, enabling years of undisturbed usage without any readjustment, in addition to the high measuring accuracy and reproducibility.

## Options/Accessories

PART #	TYPE	SARTORIUS PART #	DESCRIPTION	PRICE
160438	PR6041/805	9405 36041802	Top Plate, tank leg connection	\$360.00

## Dimensions

RATED CAPACITY	A	B	C	D	E	F	G	H	I
in/mm									
Top Cable	8.3 in (210 mm)	3.7 in (94 mm)	1.9 in (47 mm)	3.7 in (94 mm)	0.5 in (12 mm)	1.9 in (47 mm)	1.1 in (29 mm)	2.4 in (60 mm)	2.2 in (55 mm)

## Top Cable Outlet Options

TOTAL CAPACITY	LOAD CELL CAPACITY		RL PART #	SARTORIUS PART #	PRICE	
<b>3-Module Kit</b>						
660 lb	300 kg	220 lb	100 kg	158843	CTG-332B-U	\$8,585.50
1,300 lb	600 kg	440 lb	200 kg	158845	CTG-632B-U	8,585.50
1,900 lb	900 kg	660 lb	300 kg	158847	CTG-932B-U	8,585.50
3,300 lb	1,500 kg	1,100 lb	500 kg	158849	CTG-1532B-U	8,585.50
6,600 lb	3,000 kg	2,200 lb	1,000 kg	158851	CTG-3032B-U	8,585.50
13,200 lb	6,000 kg	4,400 lb	2,000 kg	158853	CTG-6032B-U	8,585.50
<b>4-Module Kit</b>						
880 lb	400 kg	220 lb	100 kg	158844	CTG-442B-U	11,258.50
1,700 lb	800 kg	440 lb	200 kg	158846	CTG-842B-U	11,258.50
2,500 lb	1,200 kg	660 lb	300 kg	158848	CTG-1242B-U	11,258.50
4,400 lb	2,000 kg	1,100 lb	500 kg	158850	CTG-2042B-U	11,258.50
8,800 lb	4,000 kg	2,200 lb	1,000 kg	158852	CTG-4042B-U	11,258.50
17,600 lb	8,000 kg	4,400 lb	2,000 kg	158854	CTG-8042B-U	11,258.50

Complete Kit Includes:

Contega load cell, junction box, load cell extension cable

# Sartorius® Intec PR5220 Ethernet Transmitter

## Standard Features PR5220

- Configuring via VNC
- OPC server
- Full digital signal processing with up to 4.8 Mio divisions internal resolution
- SmartCalibration feature for fast calibration even without weights
- Requires supply voltage of 24 VDC
- IP20 Housing, DIN Rail Mount
- Verifiable with remote display up to 10,000 e, C1 III (EN 45501, OIML R76)
- Precision analog output
- Serial RS-485/422 interface
- CD supplied with software suite
- 10,000 divisions at six samples per second

## Specifications

### Housing:

Housing IP20 according to DIN 40050  
Mounting on DIN Rail 35 mm according to DIN 46277  
material: polyamide RoHS conform

### Dimensions:

Version 00: 99 x 116 x 45 mm  
Versions 01, 04, 06, 07: 99 x 116 x 68 mm

### Supply Voltage:

24 VDC, +/-20%

### Power Consumption:

6 W / 8 W (Versions /01, /04, /06, /07)

### Control Outputs:

Quantity: 3 opto-isolated output, passive,  
Voltage: max. 30 VDC:  
Current: max. 30 mA  
Functions: Limits, weight status

### Control Inputs:

Quantity: 3, opto-isolated input, passive,  
Functions: zero setting, taring  
Voltage: max. 30 VDC  
Current: max. 10 mA

### In-Output:

All I/O circuits fully galvanically isolated from sensor input and supply.

### Load Cell Connection:

All strain gauge load cells; 6- or 4-wire connection

### Load Cell Supply:

12 V, short-circuit proof. External load cell supply possible.

### Minimum Load Impedance:

Min. 75 Ω e.g. 6 load cells with 600 Ω or 4 load cells with 350 Ω

### Measuring Principle:

Measuring amplifier: Delta-Sigma converter  
Measuring time: min 5 ms - max. 1600 ms

### Input Range:

7.5 mV (appr. 4.8 Mio. div.) Usable resolution: 0.2 µV/d

### Input Signal:

Measuring signal: 0 to 36 mV (for 100 % nominal load)

### W and M Approval (in preparation):

10,000 e class III acc. to EN 45501; according to. OIML R76, min. verification interval: 0.5 µV/e

### Linearity:

< 0.002%

### Temperature Effects:

Zero: TK0 m < 0.02 µV/K RTI  
Span: TKspan < +/- 2 ppm/K

### Digital Filter for Load Cell:

4th order (low pass), Bessel, aperiodic or Butterworth



The PR5220 Ethernet transmitter sets new standards in process instrumentation. The standard Ethernet TCP/IP interface enables easy transmission of information to superordinate systems.

## Part Number/Price

PART #	TYPE	SARTORIUS PART #	DESCRIPTION	PRICE
158856	PR5220/00	9405 152 20001	PR5220 Ethernet Transmitter TCP/IP, 4-20 mA	\$1,540.00
158857	PR5220/01	9405 152 20011	PR5220 Ethernet Transmitter TCP/IP, 4-20 mA with Profibus DP	1,849.00
158858	PR5220/04	9405 152 20041	PR5220 Ethernet Transmitter TCP/IP, 4-20 mA with DeviceNet	1,849.00
158859	PR5220/06	9405 152 20061	PR5220 Ethernet Transmitter TCP/IP, 4-20 mA with ProfiNet	1,849.00
158891	PR5220/07	9405 152 20071	PR5220 Ethernet Transmitter TCP/IP, 4-20 mA with EtherNet IP	1,849.00

## Specifications Continued

### Ethernet Interface (functions):

Ethernet IP and Modbus/TCP  
Definition of an IP address: – AutoIP; – DHCP Server classification; – manual entering of an IP address  
Automatic detection of signal transmission and corresponding change over (cross-over or patch cable)  
Webservice via SOAP/UPnP (Simple Object Access Protocol)  
Synchronal Modbus UDP

### Status Indicator:

Status LEDs to signal operation and error conditions.

### Analogue Output:

0 to 10 I or 4-20 mA, internal resolution 16-bit, usable step-width: 0.5 µA max. load 500 Ω; user configurable

### Serial Interfaces:

RS422/485 via screw terminals  
Protocol: Remote Display, SMA and Sartorius digital scales (XBPI-protocol)

### Electrical Connections:

All electrical connections via modular screw terminals for 2.5 mm<sup>2</sup> max. System Phoenix/COMBICO

### Temperature:

WandM: -10° C to 40° C  
Operation: -10° C to 50° C  
Storage: -40° C to 70° C

### Weight:

Version 00:  
Net: 0.29 kg  
Versions 01, 04, 06, 07  
Net: 0.35 kg

# Sartorius® Intec PR5230 Fieldbus Transmitter

## Standard Features

- IP66, stainless steel, electro-polished construction
- Display for weight and status information
- OIML approval for 10,000e, and an internal resolution of 4 and 8 Mio. counts
- SmartCalibration feature for fast calibration even without weights
- Serial Interface RS-485/422 and RS-232
- Option cards: analog output 0 to 10 or 4-20 mA, DeviceNet and Ethernet/IP
- Load cell connection board for up to four load cells

## Specifications

### Housing:

Housing IP66 material: stainless steel electro-polished  
RoHS conform

### Dimensions:

350 x 250 x 150 mm

### Weight:

Net: 1.45 kg

### Display and Status:

LCD, transfective, back-lit  
Weight: 6-digits  
Size: 128 + 64 pixel, graphic  
Information can be configured  
Status LEDs to signal operation and error conditions.

### Internal Keys:

In the housing 3 keys for Zero, Tare, Test

### Supply Voltage:

230 VAC, (+10/-15 %): 24 VDC, (+/-20 %)

### Power Consumption:

11 W

### Control Outputs:

Quantity: 3  
Relay output, passive,  
Functions: Limits, weight status  
Voltage: max. 30 VDC:  
Current: max. 30 mA

### Control Inputs:

Quantity: 3 opto-isolated input, passive,  
Functions: zero setting, taring  
Voltage: max. 30 VDC  
Current: max. 10 mA

### Remote I/O:

The I/O can be set internally via a function and remote via fieldbus or PC

### In/Output:

All I/O circuits fully galvanically isolated from sensor input and supply  
3 inputs/3 outputs (relays)

### Load Cell Connection:

All strain gauge load cells; 6- or 4-wire connection

### Load Cell Supply:

12 V, short-circuit proof. External load cell supply possible.

### Minimum Load Impedance:

Min. 75 Ω  
(e.g. 6 load cells with 600 Ω or 4 load cells with 350 ohm)

### Measuring Principle:

Measuring amplifier: Delta-Sigma converter  
Measuring time: min 5 ms – max. 1600 ms

### Accuracy:

7.5 nV (appr. 4.8 Mio. div.) Usable resolution: 0.2 µV/d

### LC Input Signal:

Measuring signal: 0 bis 36 mV (for 100 % nominal load)

### WandM Approval (in preparation):

10,000 e class III acc. to EN 45501; according to OIML R76, min. verification interval: 0.5 µV/e at 160 ms

### Linearity:

< 0.003 %

### Temperature Effects:

Zero: TK0 m < 0.05 µV/K RTI  
Span: TKspan < +/- 2.5 ppm/K

### Digital Filter for Load Cell:

4th order (low pass), Bessel, aperiodic or Butterworth

### Ethernet Interface for Optional IP Card:

Ethernet TCP/IP and Modbus TCP  
Definition of an IP address: – AutolP; – DHCP Server classification; – manual entering of an IP address  
Automatic detection of signal transmission and corresponding change over (cross-over or patch cable)  
Webservice via SOAP/UPnP (Simple Object Access Protocol)  
Synchronal Modbus UDP

### Serial Interfaces:

RS 422/485 and RS232  
Protocols: Remote Display, SMA, Modbus RTU, printer and Sartorius digital scales (XBPI – protocol)

### Options Analogue Output PR 5230/06 (C11):

0-10 VDC or 4 -20 mA, internal resolution 16 bit, usable stepwidth: 0.5 µA max. load 500 Ω, user configurable

### Fieldbus PR 1721/4x (C2x):

Profibus-DP, Interbus-S, DeviceNet, CC-Link, Profinet and EtherNet/IP

### Load Cell Connection Board PR 5230/22 (C31):

For the internal connection of up to 4 Load cells. (instead using a cable junction box)

### Environmental Conditions

#### Temperature:

WandM: -10 ° C to 40 ° C  
Operation: -10 ° C to 50 ° C  
Storage: -20 ° C to 70 ° C

### ATEX Approvals PR 5230:

II 3G Ex nA nC IIC T4  
II 3D Ex tD A22 IP6X T80° C  
SAG 09ATEX004X  
II (2)G [Ex ib] IIC  
II (2)D [Ex ibD]  
KEMA 10 ATEX 0065 X



The fieldbus transmitter PR5230 is a product for readout and transmit weight values to installed networks and control systems. LCD display is configurable and displays up to 10 items, and can be installed at the process. Through the different interface upgrade possibilities and the robust stainless steel housing, the PR5230 is an innovative and flexible process unit.

## APPROVALS



## Part Number/Price

PART #	TYPE	SARTORIUS PART #	DESCRIPTION	PRICE
158861	PR5230/00	9405 152 30000	PR5230 Transmitter in Field Housing	\$1,849.00

## Options/Accessories

PART #	TYPE	SARTORIUS PART #	DESCRIPTION	PRICE
158863	PR1721/47	9405 317 21471	EtherNet IP interface module	\$995.00
158864	PR1721/44	9405 317 21441	DeviceNet interface module	881.00
160431	PR5230/06	9405 152 30061	0 to 4-20 mA interface module	149.00

# Sartorius® Intec PR56 10-Pro-X5 System Controller

## Standard Features PR5220

- Monitors two weighing ports
- Built-in RS-232

## Specifications

### Display:

Vacuum-fluorescent display with serially connected data interface.  
 Weight display (top) 7 large digits for weight, dimension and status  
 Dialogue display (bottom) 2 rows each with 20 characters (dot matrix) for text.

### 6.2.3 Keypad:

For the entry, the front panel is provided with a foil-covered alphanumeric keypad with 31 keys.  
 Dimensions: 103 x 247 mm

### 6.2.4 External Keyboard:

External PC keyboard, max. 50 mA current consumption (no additional units are possible!). The DIN socket for the keyboard is protected by a multi-fuse element.

### 6.2.5 Built-in RS-232 Interface:

Terminal block connection;  
 functions: calibration, configuration, operation, communication  
 Mode RS 232, XON/XOFF, ANSI, various protocols  
 Baud rate 300 - 19200 Bd  
 Data bits 7 / 8 Bit  
 Parity none, odd, even

### Power Supply:

Power voltage 115 V/ 230 V AC (+10% / -15%) 48-62 Hz  
 Optional mode: Power voltage 24 V AC or 24V DC (+10% / -15%) 48-62 Hz  
 Power consumption 14,5 W/ 19 VA  
 Power voltage sags >10 ms at 100% sag, without instrument reaction >20 ms at 50% sag

### 6.3.2 Environmental Conditions:

Temperature range  
 Ambient operation temperature -10 to 40 ° C  
 Switch-on temperature 0 to 40 ° C  
 Storage/ transport -40 to 70 ° C  
 Humidity < 95 %, without condensation, (acc. to IEC 68-2)  
 Protection type IP 65  
 Vibration to IEC 68-2-6, test Fc

### 6.3.3 Electromagnetic Immunity:

Electrostatic discharge min. EN 61000-4-2, level 3  
 Interference (supply and data cables) min. EN 61000-4-4, level 2  
 Electromagnetic fields min. EN 61000-4-3, level 2

### 6.3.4 RF Interference Suppression:

Electromagnetic emission acc. to EN55011 group 1, limit value class B

### Dimensions:

Housing Dimensions: Width 288 mm, Height 144 mm, Depth 130 mm  
 (135 mm incl. blind plugs)

### Weight:

Net weight 3.5 kg, Shipping weight 5 kg

### DeviceNet:

DeviceNet Standard Specification DeviceNet Volume 1 Release 1.3 and Volume 2 Release 1.2  
 from 4.3.1996  
 Baud rates [kBps] 125, 250, 500  
 Common Services Get\_Attribute\_Single, Set\_Attribute\_Single, Reset



*The PRO-X5 System Controller is a multiple use device for precise weighing applications for industrial environment.*

*A wide range of interface options make it feasible for integration in all up-to-date automation concepts. The housing is designed for easy installation in cabinets, operating panels or direct at the machinery as a front-end unit. The bright weight display with 7 digits plus units and status symbols guarantees good readability even under harsh conditions.*

*The weighing indicator PR5230/00 has been designed for high precision weighing applications. Beside the standard weighing functions the PR5230/00 is prepared to communicate with host systems, PLC s etc., via serial interface or DeviceNet.*

## Part Number/Price

PART #	TYPE	PART #	DESCRIPTION	PRICE
158860	PR5610/00	9405 156 10001	Pro X5 Controller	\$2,195.00

## Options/Accessories

PART #	TYPE	PART #	DESCRIPTION	PRICE
158927	PR1721/14	9405 317 21141	DeviceNet interface module	\$640.00

# Printers

## Table of Contents

<b>Rice Lake TicketPress™</b> ..... <b>720</b>	<b>Star® SP512/SP542/SP712/SP742</b> ..... <b>754</b>
Ticket Printer	Dot Matrix Printers
<b>Rice Lake SURVIVOR® SST3®</b> ..... <b>722</b>	<b>Star® DP8340</b> ..... <b>756</b>
Washdown Label Printer	Dot Matrix Tape Printer
<b>Rice Lake GUARDIAN™</b> ..... <b>724</b>	<b>Star® TSP 847</b> ..... <b>758</b>
Steel Printer Enclosures	Receipt Thermal Printer
<b>Rice Lake GUARDIAN G-2™</b> ..... <b>724</b>	<b>Star® TSP654II/TSP743 II</b> ..... <b>759</b>
Steel Printer Enclosures	Direct Thermal Printers
<b>Rice Lake POLY GUARD</b> ..... <b>725</b>	<b>Zebra® LP/TLP 2824 Plus</b> ..... <b>761</b>
Clear Printer Enclosures	Thermal Printer
<b>Datamax-O'Neil microFlash™ 2Te</b> ..... <b>726</b>	<b>Zebra® GK Series</b> ..... <b>762</b>
Portable Printer	Label Printer
<b>Datamax-O'Neil® E-Class III</b> ..... <b>728</b>	<b>Zebra® RW 420/RW 220</b> ..... <b>764</b>
<b>Datamax-O'Neil®</b>	Thermal Portable Printer
<b>M-4206 Mark II/M-4210 Mark II</b> ..... <b>730</b>	<b>WinWedge® TAL Software</b> ..... <b>766</b>
<b>Datamax-O'Neil® I-4212e Mark II</b> ..... <b>732</b>	Wedge Software
Direct Thermal Printer	<b>DTL</b> ..... <b>767</b>
<b>Datamax-O'Neil® H-4212 / H-4310</b> ..... <b>734</b>	Direct Thermal Label
Direct Thermal/Thermal Transfer Label Printer	<b>DTL Plus/DTT/DTL-SYN</b> ..... <b>768</b>
<b>Datamax-O'Neil® DMXREW1</b> ..... <b>736</b>	<b>TTL-RFID Labels/TTL</b> ..... <b>769</b>
Label Rewinder/Unwinder	<b>Fantastock Thermal Transfer Label</b> ..... <b>770</b>
<b>EPSON® TM-T88V</b> ..... <b>737</b>	<b>TTT Standard Tag</b> ..... <b>770</b>
POS Printer	<b>SDR Super Durable Ribbon</b> ..... <b>770</b>
<b>EPSON® TM-U220</b> ..... <b>738</b>	<b>MaxWax™ GPR</b> ..... <b>771</b>
Tape Printer	General-Purpose Ribbon
<b>EPSON® TM-U295</b> ..... <b>740</b>	<b>Tape and Ticket Printer</b>
Ticket Printer	<b>Impact Ribbons</b> ..... <b>772</b>
<b>EPSON® TM-U590</b> ..... <b>742</b>	<b>Tape Printer Paper Supplies</b> ..... <b>773</b>
Ticket Printer	<b>Electronic Scale Tickets</b> ..... <b>774</b>
<b>EPSON® EU-T482 Series</b> ..... <b>744</b>	TicketPress, Rice Lake Scales - 71630 or 105182
Thermal Kiosk Printer	Hecon Printers, EL522 and EL516 - 20266
<b>GoDEX® DT2/DT4/G500</b> ..... <b>745</b>	TicketPress, SP2200, SP2000 - 20265
Label Printer	TicketPress, Blank Scale Ticket - 22263
<b>Okidata 186 Turbo</b> ..... <b>747</b>	<b>Mechanical Scale Tickets</b> ..... <b>775</b>
Microline Printers	Fairbanks™ Scales - 20260
<b>Okidata 320/390/420 Turbo</b> ..... <b>748</b>	Create Your Own Custom Ticket
Microline Printers	Howe™ Scales - 20261
<b>Printek MtP400si</b> ..... <b>750</b>	<b>Replacement Print Heads</b> ..... <b>776</b>
Mobile Printer	<b>Printer Cables</b> ..... <b>777</b>
<b>Star Nippon® NP-211/NP-2511/NP-3511</b> ..... <b>751</b>	<b>Scale Veils</b> ..... <b>778</b>
Thermal Kiosk Printer	
<b>Star® Micronics SP298</b> ..... <b>752</b>	
Dot Matrix Ticket Printer	

**ESPAÑOL** | Visit [ricelake.com/spanish](http://ricelake.com/spanish)  
to see all RLWS materials  
available in Spanish

Product names, logos, brands, and other trademarks featured  
or referred to within this publication are the property of their respective trademark holders.

# Rice Lake TicketPress™

Ticket Printer

## Specifications

**Characters Per Line:**

40 characters at 12 cpi

**Character Set:**

Full 96-character ASCII (upper and lower case set)

**Copy Capabilities:**

Single copy or up to five-part multi-copy forms  
(four part carbonless stock, five part carbon stock)

**Ribbon:**

Cartridge-type black ink ribbon (standard) purple ink ribbon (optional)  
sold separately.

**Communications:**

RS-232 standard, optional 20 mA or RS-422

**Baud Rates:**

300 to 115,200 selectable

**Parity:**

1 parity bit

**Physical Specifications:**

Overall: 5.8 H x 8 W x 11 in L  
(147 H x 203 W x 305 mm L)  
Weight: 11.4 lb (5.2 kg)

**Operating Temperature:**

14° F to 104° F (-10° C to 40° C)

**Power:**

110-250 VAC, 50 to 60 Hz with US power cord

**Approvals:**

UL and C-UL listed

**Warranty:**

One-year limited warranty



## APPROVALS



## Standard Features

- Multiple-strike, high-speed printing, 200 characters per second (CPS)
- Use with single to five-part multi-copy forms
- Remote print function via RS-232
- Weight extraction smart mode for quickly capturing streamed weight data
- Mess-free ink cartridge
- Battery-backed time/date
- Sequential ticket numbering
- Time and Date

# Rice Lake TicketPress™

Ticket Printer

## Part Number/Price

PART #	DESCRIPTION	WEIGHT	PRICE
128027	TicketPress 110-250 VAC Hz with US power cord	14 lb	\$1,395.00
128028	TicketPress 110-250 VAC with Euro plug	14 lb	1,395.00

## Options/Accessories

PART #	DESCRIPTION	PRICE
128029	20 mA interface	\$150.00
128030	RS-422 interface	100.00
128031	Ink cartridge, black	20.00
132405	Ink cartridge, purple	20.00
128032	Manual, operating	25.00
152530	Manual, maintenance	25.00
<b>Cables</b>		
130213	25-Pin D-sub male to blunt end universal cable (Rice Lake indicators)	55.00
Consult	Custom 20 mA/RS-232 serial interface cables	100.00
Consult	RS-422 cable	Consult
<b>Scale Tickets</b>		
71630	4 1/4 x 7 in, 2 part, white and yellow, Rice Lake logo, carbonless, 500/pack	50.00
105182	4 1/4 x 7 in, 3 part, white, yellow and pink, Rice Lake logo, carbonless, 500/pack	72.00
22263	4 1/4 x 5 1/2 in, 3 part, white, yellow and pink, blank, no text, carbonless, each	0.22
20265	5 1/2 x 9 in, 3 part form ES-4, all white, tear off side tab, carbon interleave, 500/pack	95.00

Custom cables are designed to interface with your specific equipment. Please specify equipment model number and connector type.

Standard cable length is 5 feet. \$2.00 charge for each additional foot.

# Rice Lake SURVIVOR® SST3®

Washdown Label Printer

## Specifications

### Print Speed:

2 in to 10 in per second  
(51 mm to 152 mm)

### Supply Roll Capacity:

8 in (203 mm) O D on 1.5 in to 3.0 in  
(38 mm to 76.2 mm) cores.

### Bar Code Modulus:

5 mil to 55 mil "X" dimension in picket fence or ladder orientations

### Media Width:

0.75 in to 4.65 in (17 mm to 118 mm)

### Media Type:

Roll fed, die-cut or continuous labels;  
perforated or continuous tag/ticket stock

### Print Length:

0.25 in to 99 in (6 mm to 2475 mm)

### Media Thickness:

0.0025 in to 0.0100 in (0.0635 mm to 0.254 mm)

### Ribbons (Optional):

Industry standard ribbon widths:  
1 in (25 mm) ribbon core, 1476 ft (450 m) in length

### Bar Codes:

Code 3 of 9, UPC-A, UPC-E, Interleaved 2 of 5, code 128, EAN-8, EAN-13, HIBC, Codabar, Plessey, UPC 2 and 5 digit addendums, Code 93, Postnet, UCC/Ean Code 128, Telepen, UPS MaxiCode, FIM, PDF417, USD-8, Datamatrix, QR Code, Aztec, TLC 39, Micro PDF417, RSS

### Graphics Support:

PCX, BMP and IMG files

### Memory:

16 MB RAM (8 MB FLASH)  
3 MB user available

### Rating/Material:

IP69K/Stainless Steel 304

### Interfaces:

USB, Centronics® Parallel port, RS-232 at 600 to 38,400 BPS

### Power Source:

Auto-sensing 103.5 to 126.50 or 207 to 253VAC at 47 to 63 Hz; US or European power cord

### Operating Temperature:

40° F to 95° F (4° C to 35° C)

### Dimensions:

27 x 14 x 13.6 in (686.8 x 355.6 x 345.4 mm)

### Approvals:

UL listed, CE marked

### Processor:

Dragon ball, 150 MHz

### Warranty:

One-year limited warranty  
One-year or 1-million linear inches on original print head. 90 days on replacement print head



## APPROVALS



## Standard Features

- IP69K rating
- Washdown 304 stainless steel enclosure
- Electronics protected from splashes
- Direct thermal
- 203 DPI print head (optional 300 dpi model)
- Label length detection
- Real time clock
- USB, serial or parallel communications
- Line mode

## Options

- Wireless or Wired Ethernet
- Heater
- Thermal transfer



# Rice Lake SURVIVOR® SST3®

Washdown Label Printer

## Part Number/Price

PART #	DESCRIPTION	WEIGHT	PRICE
107402	SST3 direct thermal, peel and present, internal rewinder included	70 lb	\$4,775.00
110303	SST3 direct thermal, peel and present, internal rewinder with heater installed	70 lb	5,130.00
111868	SST3 direct thermal, peel and present, internal rewinder, 230 VAC European power cord	70 lb	4,775.00
111871	SST3 direct thermal, peel and present, internal rewinder, 230 VAC European power cord, heater	70 lb	5,130.00
158890	SST3 direct thermal, peel and present, internal rewinder, 300 dpi	70 lb	5,295.00

## Options/Accessories

PART #	DESCRIPTION	PRICE
111121	Heater kit for SST3 115 VAC (for installs after printer has been purchased)	\$505.00
111872	Heater kit for SST3, 230 VAC (for installs after printer has been purchased)	505.00
76729	Thermal transfer option Mark II	100.00
76732	Present sensor only M Class	125.00
52412	Network connectivity (MPS-1T,) 10 mbps micro print server	495.00
35664	Pre-saturated cleaning cards, 4 in x 6 in, 25 per box	50.00
93181	Film, print head cleaning 4 in wide, 3 per box	18.00
76734	Programmer's manual (PDF included on Datamax-O'Neil® CD-ROM)	125.00
77562	Operating manual (PDF included on Datamax-O'Neil CD-ROM)	25.00
109181	Manual service SST3	15.00
76735	Maintenance manual, M class	95.00
103372	Internal LAN (Ethernet) card	250.00
113764	Wireless and LAN card, attaches to back	940.00
103374	USB Host, LAN and Wireless card	550.00

### Label Stock/Ribbon

21776	Direct thermal, 3 in W x 3 in L, 8 in diameter with perf., 2000/roll	40.25/roll
150921	Direct thermal, 4 in W x 6 in L, 8 in diameter with perf., 1000/roll	30.50/roll
25975	Direct thermal, 4.25 in W x 2.5 in L, 6 in diameter with perf., 1095/roll	25.65/roll
21785	Thermal transfer, 2 in W x 1 in L, 8 in diameter, 5500/roll	12.95/roll
21788	Thermal transfer, 4 in W x 6 in L, 8 in diameter, 1000/roll	17.90/roll
20573	Thermal transfer, 4 in W x 6.5 in L, 8 in diameter, 900/roll	19.20/roll
126629	Thermal kit, (4) 4 in labels, (2) 4 in ribbons and cleaning card	100.95
40785	Ribbon, black 2.5 in, 1187 feet, wax	18.10/roll
34056	Ribbon, black 4 in, 1182 feet, wax	25.25/roll

### Print Head

103369	Print head 203 DPI, M4210 only	495.00
--------	--------------------------------	--------

### Cables

41276	DB9 male RS-232 serial data cable with blunt end (Rice Lake indicators)	65.00
64794	DB9 RS-232 serial data cable with DB9F to DB9M	65.00
37527	6 ft parallel cable	35.00
79074	USB cable	30.00
Consult	Custom 20 mA/RS-232 serial interface cable	100.00

Custom cables are designed to interface with your specific equipment. Please specify equipment model number and connector type.

Standard cable length is 5 feet. \$2.00 charge for each additional foot.

## Rice Lake GUARDIAN™

Steel Printer Enclosures

### Specifications

**Enclosure:**

304 stainless steel; piano-style hinge

**Dimensions:**

Part #66762: 14.25 W x 14.25 H x 21.25 in D (361.2 W x 361.2 H x 539.7 mm D)

**Weight:**

Approximately 38 lb (17.2 kg)

**Warranty:**

One-year limited warranty

### Standard Features

**GUARDIAN**

- Designed to protect the Datamax-O'Neil® I-4208, I-4308 and I-4212 printers from harsh washdown environments
- Single lift-and-turn latch for easy access
- Adjustable anti-skid feet for easy leveling alignment and cleaning under unit
- Sliding label-access door
- Heavy-gauge 304 stainless steel construction for durability



Guardian Plus/Guardian Max

### Part Number/Price

PART #	DESCRIPTION	WEIGHT	PRICE
66762	Guardian stainless steel printer enclosure for Datamax-O'Neil® I-4206, I-4208, I-4308, I-4212 and Mark II	38 lb	\$2,700.00

Consult factory for additional models and pricing

## Rice Lake GUARDIAN G-2™

Steel Printer Enclosures

### Specifications

**Enclosure:**

Heavy-gauge 304 stainless steel

**Dimensions:**

Part #78672: 12.75 W x 8.25 H x 18.5 in D (323.8 W x 209.5 H x 469.9 mm D)

**Weight:**

Approximately 30 lb (13.6 kg)

**Warranty:**

One-year limited warranty

### Standard Features

**GUARDIAN G-2**

- Designed to protect the Datamax-O'Neil E-4203, LP/TLP-2844 and DT4 printers from harsh washdown environments
- Single lift-and-turn latch for easy access
- Adjustable anti-skid feet for easy leveling alignment and cleaning under unit
- Sliding label-access door
- Heavy-gauge 304 stainless steel construction for durability



Guardian G-2

### Part Number/Price

PART #	DESCRIPTION	WEIGHT	PRICE
78672	Guardian, GT for Zebra TLP2844	24 lb	\$1,150.00
99465	Guardian, GT, LP2844, GKD	24 lb	1,150.00
107638	Guardian, G-2 RL-42DT, DT4	24 lb	1,150.00
107639	Guardian, G-2 RL-42TT, G500	24 lb	1,150.00

### Options/Accessories

PART #	DESCRIPTION	PRICE
46341	Heater option	\$210.00
46342	Fan option	110.00

# Rice Lake POLY GUARD

Clear Printer Enclosures

## Specifications

### Dimensions:

Part #88531: 13 in W x 12 ¾ in T x 23 ½ in L Base  
Add ½ in sides for latches and ½ in side door  
Part #88532: 14 in W x 14 ¾ in T x 24 1/2 in L Base  
Add ½ in sides for latches and ½ in side door

### Weight:

24 lbs

### Enclosure:

¾ in Polycarbonate  
Base-Natural polyethylene (butcher's block)

### Warranty:

90-day limited warranty

## Standard Features

- Designed for use in meat and food processing plants
- Cover separates from bottom
- In washdown position, stainless latches hold bottom and cover together
- Power and data cable feed through sealed notch in back of enclosure
- Side door for easy label loading



## Part Number/Price

PART #	DESCRIPTION	PRICE
88531	Enclosure, Datamax-O'Neil® M-Class	\$1,200.00
88532	Enclosure, Datamax-O'Neil® I-Class	1,450.00
Consult	Additional models available	Consult

## Options/Accessories

PART #	DESCRIPTION	PRICE
Consult	Ventilation fan	Consult
Consult	Heater assembly with power	Consult

# Datamax-O'Neil microFlash™ 2Te

Portable Printer

## Specifications

**Technology:**

Direct Thermal

**Interface:**

RS-232 (1200 to 38K) or USB

**Weight:**

15.3 oz (0.435 kg)

**Resolution:**

203 DPI (8 dots per mm)

**Paper Dimensions:**

2.25 in (57 mm) wide, 2 in OD; 0.4 in ID Core

**Print Width:**

1.89 in (48 mm)

**Color:**

Black

**Configuration:**

Downloadable Configuration Utility

**Power:**

12-15V, built-in spike and surge protection; External DC Jack

**Overall Dimensions:**

5.5 x 4.3 x 2.5 in  
(139.7 x 109.2 x 63.5 mm)

**Operating Temperature:**

-4° F to 122° F (-20° C to 50° C)

**Charging Temperature:**

41° F to 104° F (5° C to 40° C)

**Print Font:**

Resident bitmap fonts from 5.5 to 34 characters per inch

**Power Consumption:**

Prints up to approximately 5000 in

**Bar Code Printing:**

1D and 2D

**Battery:**

Lithium Ion, 7.2V, 1800 mAh, lasts 10 hour shift, full recharge in 3 hours

**Warranty:**

Two-year limited warranty



## Standard Features

- Industrial strength design—passes 6 ft. (1.8 m) drop test
- Exclusive features:**
- Advanced 32-bit RISC processor for high-speed processing
  - LEDs to indicate Bluetooth®, charging and power status
  - External DC jack for easy charging
  - Compatible with most hand-held devices
  - Print quality of 203 DPI (8 dots/mm)
  - Print graphics, 1D bar codes and 2D symbologies
  - Store fonts, graphics and operating system in Flash memory; supports international character sets and any
  - Bitstream® bitmap font
  - Internal rechargeable battery included
  - Intelligent power management and programmable sleep mode for extended battery life
  - Charging options—external charge contacts, AC adapter, or 12V vehicle cigarette lighter adapter

# Datamax-O'Neil microFlash™ 2Te

Portable Printer

## Part Number/Price

PART #	DESCRIPTION	WEIGHT	PRICE
117437	MF2Te Serial, Swivel Mount, USB or RS-232*	2lb	\$550.00

*Integrated battery (belt clip and paper)*

*\*Charging system sold separately*

## Options/Accessories

PART #	DESCRIPTION	PRICE
117438	AC Adapter, US Plug	\$55.00
117439	AC Adapter, Euro Plug	60.00
117440	Swivel Mount Bracket	45.00
117441	Six (6) Ft AMP Right Angle Power Extension Cord	110.00
117442	Cable, DB9-F Coiled Right Angle	45.00
117443	Replacement Battery, 1800mAh kit	105.00
118455	Fuse box cable	140.00
118456	USB RT Angle RJ	39.00
75947	2.25 in x 85 ft thermal paper, 1/2 in core	6.00



Fuse Box Power Cable Kit



IP54 Case for 4Te



Swivel Mount Bracket



DB9 F Cable

USB Cable

# Datamax-O'Neil® E-Class III

## Specifications

### Print Speed:

Basic: 4 inches per second  
Advanced: 5 Inches per second (IPS) (127 mm/s)

### Print Length Range:

0.375 to 99 in (9.5 to 2514 mm)

### Print Width:

4.25 in maximum

### Media Types:

Label Roll OD: Max 5.0 in  
Core: 1 in  
Fan-fold, die-cut or continuous labels, perforated or continuous tag/ticket stock  
Width: 0.75 to 4.4 in  
Thickness: 0.0025 to 0.01 in  
Sensing: Basic -Fixed position  
Advanced: Positional adjustable sensors capable of gap between labels, black bar on back, and notch or hole sensing

### Printer language:

DPL, PL-Z or PL-E emulation

### Ribbon:

Coated side in or coated side out (CSI/CSO)  
Width range 1.0-4.3 in (25 to 109 mm)  
Core: 0.5-1.0 in (13 to 25 mm)

### Resident Fonts:

10 alphanumeric fonts from 0.08 to 0.25 in including OCR-A, OCR-B, CG Triumvirate smooth font from AGFA

### Bar Codes:

Linear -Code 3 of 9, Code 93, Code 128), UCC/EAN-128, UPC E, EAN 8/13, Interleaved 2 or 5, Codabar, Post Net, HIBC, UPC 2 and 5 Addendums, Plessey, and Telepen

### 2-D Symbologies:

MaxiCode, PDF417, Datamatrix, QR Code, USD-8, Aztec, TLC 39, Micro PDF417

### Dimensions:

8.01 x 7.36 x 11.1 in (203.5 x 187 x 282 mm)

### Memory:

64MB Flash/16 MB DRAM

### Interfaces:

Baud rate: up to 38,400 BPS  
Standard: USB and RS-232 (DB-9)  
Advanced Model Mini-Parallel Centronics also

### Power:

Auto Switching 100/240 VAC, 50/60 Hz, US Power Cord

### Environment:

Operation: 40° F to 95° F (4° C to 35° C)

### Operating Temperature:

40° F to 95° F (4° C to 35° C)

### Weight:

5.2 lb (2.4 kg)

### Warranty:

One-year limited warranty



## Standard Features

- 203 DPI (8 dots/mm) print resolution
- Drop in media loading
- USB, RS-232, or Parallel
- Gap label, black mark plain or fanfold label
- Label length detection
- Direct Thermal and Thermal Transfer Models
- Rugged construction to double wall and concentric hinges
- Media viewing window
- Field installable options
- NETira software

# Datamax-O'Neil® E-Class III

## Part Number/Price

PART #	DESCRIPTION	WEIGHT	PRICE
<b>Basic Model</b>			
121119	Printer, E-4204B Direct Thermal, Tear Bar 110/240VAC printer	6 lb	\$495.00
<b>Advanced Mode</b>			
121120	Printer, E-4205A, Direct Thermal, 110/240 V printer	6 lb	595.00
121122	Printer, E-4205A, Direct Thermal, Peel and Present 110/240 V printer	6 lb	630.00
121121	Printer, E-4205A, Thermal Transfer, Peel and Present, 110/240 V printer	6 lb	730.00

## Options/Accessories

PART #	DESCRIPTION	PRICE
126769	Peel and Present option for basic model	\$145.00
64794	RS-232 DB9F to DB9M 9-Pin serial cable	65.00
79074	USB cable	30.00
41276	6 ft serial cable, DB9 to blunt end (Rice Lake indicators)	65.00
68517	External Rewinder/Unrewinder DMXREW1, 110 V	495.00
112517	Printhead, 203 dpi E-Class II/III	125.00
38941	Cleaning pens for open print head printers, 12 per box	57.00
<b>Label Stock/Ribbon</b>		
40332	Direct thermal, 2.25 W x 2 in L, 5 in diameter with perf., 1445 per roll	14.25
53251	Direct thermal, 4.0 W x 3 in L, 5 in diameter with perf., 930 per roll	23.35
40331	Direct thermal, 4.0 W x 4.0 in L, 5 in diameter with perf., 745 per roll	23.35
37345	Direct thermal, 4.0 W x 6.0 in L, 5 in diameter with perf., 450 per roll	20.00
53261	Thermal transfer, 4.0 W x 3.0 in L, 5 in diameter with perf., 930 per roll	18.05
35477	Ribbon, 3.5 in x 360 ft, general purpose	8.25
35478	Ribbon, 4.33 in x 360 ft, general purpose	10.65

# Datamax-O'Neil® M-4206 Mark II/M-4210 Mark II

## Specifications

### Print Speed:

- M-4206 Mark II: 2 in to 6 in per second (51 mm to 152 mm)
- M-4210 Mark II: 2 in to 10 in per second (51 mm to 152 mm)
- M4308: 2 in to 8 in per second (51 mm to 203 mm)

### Supply Roll Capacity:

- 8 in (203 mm) O D on 1.5 in to 3.0 in (38 mm to 76.2 mm) cores. Fanfold stock accepted from rear and bottom of printer.

### Bar Code Modulus:

- 5 mil to 55 mil "X" dimension in picket fence or ladder orientations

### Media Width:

- 0.75 in to 4.65 in (17 mm to 118 mm)

### Media Type:

- Roll fed or fan-fold materials, die-cut or continuous labels; perforated or continuous tag/ticket stock

### Print Length:

- 0.25 in to 99 in (6 mm to 2475 mm)

### Media Thickness:

- 0.0025 in to .01 in (.0635 mm to .254 mm)

### Ribbons:

- Industry standard ribbon widths; 1 in (25 mm) ribbon core, 1476 ft (450 m) in length

### Bar Codes:

- Code 3 of 9, UPC-A, UPC-E, Interleaved 2 of 5, Code 128, EAN-8, EAN-13, HIBC, Codabar, Plessey, UPC 2 and 5 digit addendums, Code 93, Postnet, UCC/EAN Code 128, Telepen, UPS MaxiCode, FIM, PDF417, USD-8, Datamatrix, QR Code, Aztec, TLC 39, Micro PDF417, RSS

### Graphics Supported:

- .PCX, .BMP and .IMG files

### Memory:

- M4206: 8MB RAM (8MB FLASH), 1MB user available
- M4210: 16MB RAM (8MB FLASH), 3MB user available

### Construction:

- Metal

### Interfaces:

- USB, Centronics® Parallel port, RS-232 at 600 to 38,400 BPS

### Power Source:

- Auto-sensing 90 to 132 or 180 to 264VAC at 47 to 63 Hz; specify appropriate power supply and cord when ordering

### Operating Temperature:

- 40° F to 95° F (4° C to 35° C)

### Overall Dimensions:

- 10.21 H x 10.10 W x 18.19 in D (259 H x 257 W x 462 mm D)

### Approvals:

- UL listed, CSA certified, CE marked, TUV-GS safety standards, FCC Class A emissions, RoHS and WEE compliant

### Processor:

- M-4206 Mark II Dragonball, 100 MHz
- M-4210 Mark II Dragonball, 150 MHz

### Weight:

- 27 lb

### Warranty:

- One-year limited warranty.
- One-year or 1-million linear inches on original print head.
- 90 days on replacement print head.



## APPROVALS



## Standard Features

- 203 DPI (8 dots/mm) print resolution (M4308, 300 dpi)
- Light weight die-cast aluminum frame
- Supplies loading diagram embossed into the frame
- Collapsible ribbon hub for loading and unloading of ribbons
- Media window
- Scaleable font engine
- USB, serial and parallel communications
- Reverse fields/mirror image (fonts/graphics can be printed as a normal or reverse image)
- Real time clock (M-4210)
- Support CD-ROM (contains DMX EM conf. tool, Windows® print drivers and manuals)
- Line mode
- LCD Graphical Display

## Option

- R-series RFID HF and UHF M210 Mark II



# Datamax-O'Neil® M-4206 Mark II/M-4210 Mark II

## Part Number/Price

PART #	DESCRIPTION	WEIGHT	PRICE
<b>M-4206 Mark II</b>			
103364	Label Printer, M-4206 Mark II Direct Thermal, 115/230 VAC	27 lb	\$1,145.00
103365	Label Printer, M-4206 Mark II Direct Thermal, 115/230 VAC, Ethernet	27 lb	1,395.00
<b>M-4210 Mark II</b>			
103367	Label Printer, M-4210 Mark II Direct Thermal, 115/230 VAC	27 lb	1,395.00
103366	Label Printer, M-4210 Mark II Direct Thermal 115/230 VAC, Ethernet	27 lb	1,645.00
108891	Label Printer, M-4210 Mark II Direct Thermal, peel and present, internal rewind	30 lb	1,800.00
158826	Label Printer, M-4308, Mark II, Direct Thermal, peel and present, and internal rewinder	30 lb	1,970.00
Consult	Label Printer, M-4308 models by request		Consult

## Options/Accessories

PART #	DESCRIPTION	PRICE
76729	Thermal transfer option (coated side in)	\$100.00
76730	Peel mechanism and present sensor (requires internal rewinder)	205.00
76731	Internal rewinder	200.00
76732	Present sensor only	125.00
76733	Standard cutter kit for 10 mil stock	495.00
35664	Pre-saturated cleaning cards, 4 in x 6 in 25/box	50.00
93181	Film, print head cleaning 4 in wide, 3 per box	18.00
76734	Programmer's manual (PDF included on Datamax-O'Neil CD-ROM)	125.00
77562	Operating manual (PDF included on Datamax-O'Neil CD-ROM)	25.00
103372	Internal LAN (Ethernet) Card	250.00
103373	Wireless and LAN Card	475.00
103374	USB Host, LAN and Wireless Card M-4210 only	550.00
<b>Label Stock/Ribbon</b>		
21776	Direct thermal, 3 in W x 3 in L, 8 in diameter with perf., 2000/roll	40.25/roll
150921	Direct thermal, 4 in W x 6 in L, 6 in diameter with perf., 1000/roll	30.50/roll
25975	Direct thermal, 4.25 in W x 2.5 in L, 6 in diameter, with perf. 1095/roll	25.65/roll
21785	Thermal transfer, 2 in W x 1 in L, 8 in diameter, 5500/roll	12.95/roll
21788	Thermal transfer, 4 in W x 6 in L, 8 in diameter, 1000/roll	17.90/roll
20573	Thermal transfer, 4 in W x 6.5 in L, 8 in diameter, 900/roll	19.20/roll
40785	Ribbon, black, 2.5 in, 1187 feet, wax	18.10/roll
34056	Ribbon, black, 4 in, 1181 feet, wax	25.25/roll
126629	Thermal kit, (4) 4 x 4 in labels, (2) 4 in ribbons and 1 cleaning card	100.95
<b>Print Head</b>		
103369	Print head 203 DPI M-class, M4210 only	495.00
103368	Print head 203 DPI M-4206	495.00
<b>Cables</b>		
41276	DB9 male RS-232 serial data cable with blunt end (Rice Lake indicators)	65.00
64794	DB9 RS-232 serial data cable with DB9F to DB9M	65.00
37527	6 ft parallel cable	35.00
79074	USB Cable 6 ft USB-A male to USB-B male, 6 ft	30.00

# Datamax-O'Neil® I-4212e Mark II

Direct Thermal Printer

## Specifications

**Print Speed:**

12 in per second (305 mm)

**Resolution:**

203 DPI (8 dots/mm)

**Maximum Print Width:**

4.094 in (104 mm)

**Media Width:**

1 in to 4.65 in (25 to 118 mm)

**Print Length:**

0.25 in to 99 in (6 to 2475 mm) .75 in (19 mm) minimum print length with optional present sensor

**Supply Roll:**

8 in (203 mm) maximum diameter on 1.5 in to 3 in (38 to 76 mm) core. Fan-fold stock accepted from rear of printer

**Revolving Media Hubs:**

Standard in 1.5 in and 3 in; optional 40 mm

**Ribbons:**

Industry standard ribbon widths; 1 in (25 mm) ribbon core, 1968 ft (600 m) in length Auto Sensing option

**Bar Codes:**

Code 39, Interleaved 2 of 5, Code 128 (subsets A,B and C), Codabar, LOGMARS, UPC-A, UPC-E, UPC 2 and 5 digit addendums, EAN-8, EAN-13, EAN 2 and 5 digit addendums, UPC random weight, Code 93, MSI Plessey, Universal Shipping Container Symbology, UCC/EAN Code 128, QR Code, Postnet, Code 128 MOD 43, PDF 417, Micro PDF, UPS MaxiCode (mode 2 and 3), Datamatrix, Telepen, Aztec Code

**Graphics Support:**

.PCX, .BMP and .IMG files

**Dimensions:**

12.7 H x 12.62 W x 18.6 in D (322.6 H x 320.5 W x 472.4 mm D)

**Interfaces:**

Centronics® Parallel port (IEEE 1284 compliant), RS-232 at 300 to 38,400 BPS, USB, optional Ethernet

**Power Source:**

Auto-sensing 90-264VAC at 47-63 Hz; specify appropriate power cord when ordering

**Approvals:**

UL listed, CSA certified, CE marked, RoHS and WEE compliant

**Warranty:**

One-year limited warranty on parts.  
One-year or 1 million linear inches on original print head.  
90 days on replacement print head



## APPROVALS



## Standard Features

- 203 DPI (8 dots/mm) print resolution
- Easy-to-read Liquid Crystal Display (LCD)
- Scaleable engine
- 3 in/1.5 in (76.2/38.1 mm) revolving media hub
- 32MB/64MB memory
- Media window
- Datamax-O'Neil® CD-ROM (contains Windows® print drivers and manuals)
- NETira software

# Datamax-O'Neil® I-4212e Mark II

Direct Thermal Printer

## Part Number/Price

PART #	DESCRIPTION	WEIGHT	PRICE
131143	Label Printer, I-4212e Direct Thermal, 115 VAC	50 lb	\$1,595.00
131145	Label Printer, I-4212e Direct Thermal, 115 VAC, with internal rewind	50 lb	1,795.00
131146	Label Printer, I-4212e Direct Thermal, 115VAC Peel and Present, internal rewind	50 lb	1,945.00
131144	Label Printer, I-4212e Direct Thermal, 230 VAC, Euro and British cord	50 lb	1,595.00

## Options/Accessories

PART #	DESCRIPTION	PRICE
131147	Thermal transfer option bidirectional	\$100.00
131148	Peel mechanism and present sensor (requires internal rewinder)	205.00
131149	Internal rewinder	200.00
131150	Internal Ethernet, interface kit (field installable)	325.00
131151	Wired LAN 802.11 a/b/g with WPA 2 security protocol	500.00
53918	Standard cutter kit for 10 mil stock	695.00
131152	GP10 applicator interface card	225.00
35664	Pre-saturated cleaning cards, 4 in x 6 in, 25/box	50.00
93181	Film, print head cleaning 4 in wide, 3/box	18.00
38941	Cleaning pens, 12 per box	57.00
64898	Additional programmer's manual	125.00
64896	Additional maintenance manual	129.00
75098	Additional operating manual	60.00
53918	Cutter kit	695.00
<b>Label Stock/Ribbon</b>		
21776	Direct thermal, 3 in W x 3 in L, 8 in diameter with perf., 2000/roll	40.25/roll
150921	Direct thermal, 4 in W x 6 in L, 8 in diameter with perf., 1000/roll	30.50/roll
25975	Direct thermal, 4.25 in W x 2.5 in L, 6 in diameter with perf., 1095/roll	25.65/roll
21785	Thermal transfer, 2 in W x 1 in L, 8 in diameter, 5500/roll	12.95/roll
21788	Thermal transfer, 4 in W x 6 in L, 8 in diameter, 1000/roll	17.90/roll
20573	Thermal transfer, 4 in W x 6.5 in L, 8 in diameter, 900/roll	19.20/roll
126629	Thermal kit, (4) 4 x 4 in labels, (2) 4 in ribbons and 1 cleaning card	100.95
40785	Ribbon (black), 2.5 in, 1187 ft, wax	18.10/roll
34056	Ribbon (black), 4 in, 1181 ft, wax	25.25/roll
<b>Cables</b>		
41276	DB9 male RS-232 serial data cable with blunt end (Rice Lake indicators)	65.00
64794	DB9F to DB9M RS-232 cable	65.00
79074	USB cable, 6 ft USB-A M to USB-B M	30.00
37527	6 ft parallel cable	35.00
<b>Print Head</b>		
131153	Printhead, 203 dpi, I-4212e	450.00

# Datamax-O'Neil® H-4212 / H-4310

Direct Thermal/Thermal Transfer Label Printer

## Specifications

### Print Speed:

H-4310(x): 2 in to 10 in per second  
 H-4212(x): 2 in to 12 in per second (50.8 to 304.8 mm) in 0.5 in (0.01 mm) programmable increments

### Resolution:

H-4212x-200 DPI  
 H-4310x-300 DPI

### Maximum Print Width/Length:

Width: 4.10 in (H-4212x) 4.16 in (H-4310x);  
 Length: 0.25 in to 99 in (6 to 2475 mm) 0.75 in (19 mm) minimum print length with optional present sensor

### Media Width:

1 in to 4.65 in (25 mm to 118 mm)

### Supply Roll:

8 in (203 mm) maximum diameter on 3 in (76 mm) core. Fan-fold stock accepted from rear and bottom of printer

### Ribbons:

Industry standard ribbon widths; 1 in (25 mm) ribbon core, 1968 ft (600 m) in length

### MCL:

Macro Command Language allows printer to control the printing application

### Dimensions:

H-4212: 13.0 H x 12.6 W x 18.9 in D  
 H-4310: 16.37 H x 12.51 W x 18.83 in D  
 RFID printers (Contact Rice Lake)  
 CABINET: Metal construction, clear side window

### Bar Codes:

Code 3 of 9, Interleaved 2 of 5, Code 128, Codabar, UPC-A, UPC-E, UPC 2 and 5 digit addendums, EAN-8, EAN-13, EAN 2 and 5 digit addendums, Code 93, Plessey, UCC/EAN Code 128, Postnet, PDF 417, UPS MaxiCode, Datamatrix, FIM, Telepen, HIBC, Aztec, TLC39, QR Code, PDF417, USD-8, Micro PDF417, RSS, USPS-4

### Graphics Support:

.PCX, .BMP and .IMG files

### Memory:

8MB Flash Memory; 16MB DRAM memory

### Interfaces:

Centronics® Parallel port (IEEE 1284 compliant), RS232/422 at 2,400 to 38,400 BPS Ethernet, USB

### Power Source:

Auto-sensing 115, 230VAC 50/60Hz; specify appropriate power cord when ordering

### Operating Temperature:

32° F to 100° F (0° C to 38° C)

### Approvals:

UL listed, CSA certified, CE marked, FCC Class A emissions standard, TUV-GS safety standards, RoHS and WEE compliant

### Weight:

47 lb

### Warranty:

One-year limited warranty on parts.  
 One-year or 1 million linear inches on original print head.  
 90 days on replacement print head.



## APPROVALS



## Standard Features

- Peel and present
- Thermal transfer
- Nine bitmapped fonts
- Scalable engine
- Revolving media hub
- Media window
- 16MB RAM (optional)
- 8MB flash ROM
- Options easily field installed
- Datamax-O'Neil CD-ROM (contains Windows® print drivers and manuals)
- MCL Enabled
- Optional R series RFID and RFID ready printers
- Real time clock
- Secure digital input (SDID) card slot-SDID flash memory card

# Datamax-O'Neil® H-4212 / H-4310

Direct Thermal/Thermal Transfer Label Printer

## Part Number/Price

PART #	DESCRIPTION	WEIGHT	PRICE
<b>H-4212</b>			
96885	Label Printer, H-4212X, Direct/Thermal transfer, internal rewind 203 DPI	47 lb	\$3,330.00
<b>H-4310</b>			
96886	Label Printer, H-4310X, Direct/Thermal transfer, internal rewind 300 DPI	54 lb	3,530.00

## Options/Accessories

PART #	DESCRIPTION	PRICE
96940	Metal thermal transfer option (coated side in/out)	\$200.00
96941	HD peel mechanism and present sensor (requires interval rewinder)	195.00
96942	Basic peel and present sensor (requires internal rewinder)	100.00
96943	Powered internal rewinder, full roll	325.00
96952	Present sensor only option	95.00
96954	Internal ILPC font kit-CG Times	10.00
96955	DMXrfNet Internal 802.11b WiFi card	525.00
68517	External rewinder/unrewinder DMX	495.00
96956	Standard cutter kit for 10 mil stock	1,395.00
53913	Expansion board 8 MB flash	165.00
64889	I/O expansion Kanji	165.00
<b>Label Stock/Ribbon</b>		
21776	Direct thermal, 3 in W x 3 in L, 8 in diameter with perf., 2000/roll	40.25/roll
150921	Direct thermal, 4 in W x 6 in L, 6 in diameter with perf., 460/roll	30.50/roll
25975	Direct thermal, 4.25 in W x 2.5 in L, 6 in diameter with perf., 1095/roll	25.65/roll
21785	Thermal transfer, 2 in W x 1 in L, 8 in diameter, 5500/roll	12.95/roll
21788	Thermal transfer, 4 in W x 6 in L, 8 in diameter, 1000/roll	17.90/roll
20573	Thermal transfer, 4 in W x 6.5 in L, 8 in diameter, 900/roll	19.20/roll
126629	Thermal kit, (4) 4 in labels, (2) 4 in ribbons and 1 cleaning card	100.95
40785	Ribbon (black), 2.5 in, 1,181 feet wax	18.10/roll
34056	Ribbon (black), 4 in, 1,181 feet wax	25.25/roll
<b>Print Head</b>		
96957	Print head 203 DPI (H-4212x)	450.00
96958	Print head 300 DPI (H-4310x)	695.00
<b>Cables</b>		
15547	Blunt end, 25-Pin D-sub male RS-232 serial interface cable (Rice Lake indicators)	65.00
37527	6 ft parallel cable	35.00
41502	PC to printer DB9 AT-style interface cable	55.00
79074	USB cable 6 ft	30.00
64794	RS-232 DB9FM/M null modem	65.00

Note: The following models are available by special order:

H-6210= 6 in wide, 203 DPI

H-6308= 6 in wide, 300 DPI

H-4408= 4 in wide, 400 DPI

H-4606= 4 in wide, 600 DPI

# Datamax-O'Neil® DMXREW1

Label Rewinder/Unwinder

## Specifications

**Label Width:**

Up to 4.5 in (113 mm)

**Maximum Label Roll Weight:**

8.5 lb (3.9 kg)

**Label Roll Diameter:**

Up to 8 in (200 mm)

**Core Diameter:**

Use any cardboard core from 1 in to 4 in (25 to 102 mm)

**Speed:**

Up to 10 ips (25+ mm/sec)

Switch adjustable rewind force

No adjustments are required

Start/Stop:

Convenient ON-OFF switch

**Direction:**

Bidirectional

**Power Requirements:**

115VAC 60 Hz

**Overall Size:**

9 H x 6 W x 11 in D (229 H x 152 W x 279 mm D)

**Weight:**

13 lb (5.9 kg)

**Approvals:**

UL listed, CSA certified

**Warranty:**

One-year limited warranty on parts and labor.



## APPROVALS



## Standard Features

- Rewinds or dispenses label rolls up to 4 in (101.6 mm) wide, up to 8 in (203 mm) in diameter at 10 (254 mm) inches per second
- Adjustable core holder
- Coreless rewinding
- Steel construction
- Anti-slip feet
- Constant Adjustable Torque™ technology
- Bidirectional operation
- ON-OFF start/stop switch
- Inner label flange to keep edge of label web aligned as labels are rewound
- Compatible with all Datamax-O'Neil® I Series and Rice Lake SURVIVOR® SST printers

## Part Number/Price

PART #	DESCRIPTION	WEIGHT	PRICE
68517	DMXREW1 label rewinder/unwinder, 115VAC	14 lb	\$495.00

# EPSON® TM-T88V

POS Printer

## Specifications

### Interface:

Built-in USB and serial interface; Built-in USB and Ethernet; or Built-in USB and Wireless LAN

### Data Buffer:

Receive buffer: Selectable as 45 bytes or 4 KB using the DIP switch

### Paper Dimensions:

80mm: 3.13 in x 3.27 in diameter or 58mm: 2.26 in x 3.27 in diameter

### Weight:

1.6 kg (3.53 lb)

### Color:

Gray

### Paper Thickness:

55-80 µm

### Print Speed:

300 mm/s {11.81 inch/s}

### Safety Standards:

EMI: FCC/ICES-003 Class A

Safety standards: UL60950-1/CSA C22.2 No.60950-1

### Power:

24VDC ±7%

### Power Consumption:

Approx. 1.8A (mean)

### Temperature:

Operating : 31° F to 113° F (5° C to 45° C)

Storage: 14° F to 122° F (-10° C to 50° C)

### Reliability:

MTBF: 360,000 hours

MCBF: 70 million lines

### Overall Dimensions: (W x D x H):

5.71 x 7.68 x 5.83 in (145 x 195 x 148 mm)

### Warranty:

One-year warranty



## Standard Features

- High-speed printing of both text and graphics (up to 300 mm/second)
- True grayscale image printing
- Best-in-class reliability
- Convenient drop-in paper loading, auto cutter and status LEDs
- ENERGY STAR® qualified
- Accommodates 58 or 80 mm paper roll
- Paper saving print features
- Improved cover protects from dust and debris
- OS support for Microsoft® Windows® 7, Vista, XP, 2000; Mac OS X v10.4, v10.5, v10.6 (Power PC/Intel Processor) and Linux

## Part Number/Price

PART #	DESCRIPTION	PRICE
117233	TM-T88V, RS-232 and USB, PS-180 Power supply	\$580.00
117234	TM-T88V, USB and Wireless Ethernet, 802.11 B PS-180 Power supply	825.00

## Options/Accessories

PART #	DESCRIPTION	PRICE
23112	Power supply, PS-180	\$110.00
69917	One-ply thermal paper roll, 3.125w x 3.25 diameter 7/16 in core 295 ft/roll	5.00
83007	Parallel Option connect-it cartridge	62.00
15568	25-Pin D-sub male to 25-Pin D-sub male RS-232 serial interface cabl	65.00
15547	Blunt end, 25-Pin D-sub male RS-232 serial interface (Rice Lake indicators)	65.00
Consult	Custom RS-232 serial cable	Consult
79074	USB-A (male) to USB-B (male) cable	30.00

# EPSON® TM-U220

Tape Printer

## Specifications

**Print Speed:**

Approximately 4.7 lines per second

**Column Capacity:**

40/42 or 33/35 columns

**Characters Per Line:**

40 characters

**Print Area:**

3 in (76.2 mm) W

**Character Formation:**

7 x 9 and 9 x 9 dot matrix

**Character Height:**

0.12 standard font

**Character Set:**

95 alphanumeric characters,  
37 international characters,  
128 x 12 graphic characters

**Line Spacing:**

0.17 in (4.32 mm)

**Print Head Life:**

Approximately 100 million strokes/pin

**Form Thickness:**

0.002 in to 0.003 in (0.06 to 0.085 mm)

**Ribbon:**

Cassette-type purple ribbon. Ribbon life is approximately 1.5 million characters (continuous prints). Black ink also available.

**Serial Interfaces:**

RS-232 compatible (25-Pin D-sub)

**Baud Rates:**

4800, 9600

**Parity:**

7 or 8 bits, none, even or odd

**Operating Temperature:**

32° F to 122° F (0° C to 50° C)

**Stop Bits:**

1 or more

**Handshaking:**

DTR/DSR or XON/XOFF control selectable

**Overall Dimensions:**

Type A: 6.3 W x 11.3 D x 6.2 in H (160 W x 286 D x 157.5 mm H)

Type D: 6.3 W x 9.7 D x 5.4 in H (160 W x 248 D x 138.5 mm H)

**Approvals:**

UL listed, CSA-certified, CE marked

**Warranty:**

Two-year limited warranty (includes print head)



Shown with rewriter option

## APPROVALS



## Standard Features

- 9-Pin Dot Matrix print head
- High-speed 4.7 to 6.0 lines per second printing
- Drop-in paper set and auto paper loading
- Automatically transmits changes in printer status
- RS-232
- Optional connect-it cartridges for parallel, USB, 10 Base-T
- Uses MI88D mechanism



# EPSON® TM-U220

Tape Printer

## Part Number/Price

PART #	DESCRIPTION	WEIGHT	PRICE
81076	TM-U220D, RS-232, 115/230VAC	10 lb	\$420.00
81077	TM-U220A, internal rewind and cutter, RS-232, 115/230VAC	10 lb	625.00
164387	TM-U220D, USB, 115/230VAC	10 lb	450.00

## Options/Accessories

PART #	DESCRIPTION	PRICE
83007	Parallel option connect-it cartridge	\$62.00
35666	Protective dust cover	60.00
31296	Ink cartridge (purple)	12.00
*66499	Ink cartridge (black and red)	12.00
69916	One-ply Bond paper roll, 3 in W x 150 ft L (76.2 mm W x 45.7 m L) 3 in OD	5.00/roll
69915	Two-ply Bond paper roll, 3 in W x 90 ft L (76.2 mm W x 27.4 m L) white/canary yellow 3 in OD	7.00/roll
35667	Additional operating manual	16.00
72309	Power supply, 12VDC vehicle cigarette plug	185.00
23112	115 VAC power supply (included with printer)	110.00
<b>Cables</b>		
15568	25-Pin D-sub male to 25-Pin D-sub male RS-232 serial interface cable	65.00
15547	Blunt end, 25-Pin D-sub male RS-232 serial interface cable (Rice Lake indicators)	65.00

Interfaces to: Rice Lake indicators with a serial port screw terminal connection Consult Custom 20 mA/RS-232 serial interface cable100.00 Custom cables are designed to interface with your specific equipment. Please specify equipment model number and connector type. Standard cable length is 5 feet. \$2.00 charge for each additional foot.

\*Red/Black ribbon to turn on ASCII code-27,1,14,48 ON 27,1,14,49 OFF

# EPSON® TM-U295

Ticket Printer

## Specifications

**Print Speed:**

1.9 to 2.3 lines per second (5 x 7 character, 3 dot line spacing)

**Column Capacity:**

35/42 columns

**Characters Per Line:**

35 standard font

**Print Area:**

2.59 in W (65.8 mm W)

**Character Formation:**

5 x 7 and 7 x 7 dot matrix

**Character Height:**

0.11 standard font

**Character Set:**

Full 96-character ASCII; with software control,  
32 international characters,  
128 x 2 graphic characters

**Line Spacing:**

0.16 in (4.06 mm) software programmable in 1/60 in units

**Print Head Life:**

Approximately 100 million strokes/pin

**Form Thickness:**

Single-ply: 0.003 in to 0.009 in (0.08 to 0.23 mm)  
Copy paper: 0.003 in to 0.014 in (0.08 to 0.36 mm)

**Ribbon:**

Cassette-type purple ribbon. Ribbon life is approximately 1.5 million characters (continuous prints). Black ink also available.

**Serial Interfaces:**

RS-232 compatible (25-Pin D-sub)

**Baud Rates:**

1200, 2400, 4800, 9600, selectable

**Parity:**

7 or 8 bits, none, even or odd

**Stop Bits:**

1 or more

**Handshaking:**

DTR/DSR or XON/XOFF control selectable

**Overall Dimensions:**

7.08 W x 7.49 D x 3.99 in H (180 W x 190.5 D x 101.5 mm H)

**Approvals:**

UL listed, CSA certified, CE marked

**Warranty:**

One-year limited warranty (includes print head)



## APPROVALS



## Standard Features

- High-speed 1.9 to 2.3 lines per second printing
- Single copy or up to four-part multicopy ticket printing
- Functions in slave capacity, printing information sent via RS-232
- Uses M66 mechanism

# EPSON® TM-U295

Ticket Printer

## Part Number/Price

PART #	DESCRIPTION	WEIGHT	PRICE
23113	TM-U295 Ticket Printer, RS-232, 115/230VAC with power supply, cool white	9 lb	\$615.00
35891	TM-U295 Ticket Printer, 115/230VAC with RS-232 and power supply, 25 DB to blunt end cable, cool white	9 lb	660.00
33816	TM-U295 Ticket Printer, RS-232, 24VDC, cool white	9 lb	585.00

## Options/Accessories

PART #	DESCRIPTION	PRICE
29582	Protective dust cover	\$55.00
29584	Ink cartridge (purple) ERC-27	12.00
29583	Ink cartridge (black) ERC-27B	12.00
23112	Power supply	110.00
34344	Additional operating manual	20.00
72309	Power supply, 12VDC vehicle cigarette plug	185.00
<b>Cables</b>		
15568	25-Pin D-sub male to 25-Pin D-sub male RS-232 serial interface cable	65.00
15547	Blunt end, 25-Pin D-sub male RS-232 serial interface cable (Rice Lake indicators)	65.00
41279	25-Pin D-sub male to 9-Pin D-sub male, RS-232 with handshaking	65.00
32810	25-Pin D-sub male to 8-Pin D-sub male, RS-232 with handshaking	65.00
Consult*	Custom 20mA/RS-232 serial interface cable	100.00

\*Custom cables are designed to interface with your specific equipment. Please specify equipment model number and connector type.

Standard cable length is 5 feet. \$2.00 charge for each additional foot.

# EPSON® TM-U590

Ticket Printer

## Specifications

**Print Method:**

9-Pin, serial impact dot matrix

**Font:**

7 x 9 and 9 x 9

**Column Capacity:**

88/66 columns

**Character Size:**

0.05 in W x 0.12 in H/0.06 in W x 0.12 in H  
(1.3 mm W x 3.1 mm H/1.6 mm W x 3.1 mm H)

**Character Set:**

Alphanumeric: 95  
International: 32  
Graphic: 128 x 10

**Characters Per Inch:**

16.7 CPI/12.5 CPI

**Serial Interfaces:**

RS-232/Bidirectional parallel/RS-485

**Data Buffer:**

4K/69 bytes

**Paper Dimensions:**

2.76 W x 2.76 in L to 8.26 W x 11.69 in L (70 W x 70 mm L to 210 W x 297 mm L)

**Paper Thickness:**

0.003 in to 0.014 in (0.09 mm to 0.36 mm)

**Copy Capabilities:**

One original and four copies

**Power:**

24VDC ± 10%

**Power Consumption:**

Approx. 43W

**D.K.D Function:**

2 drives

**Ribbon:**

ERC-31 (purple)

**Overall Dimensions:**

9.92 W x 10.47 D x 7.28 in H (252 W x 266 D x 185 mm H)

**Approvals:**

CE marked, FCC class A, VCC #1,  
UL and C-UL listed, TUV

**Warranty:**

One-year limited warranty (includes print head)



## APPROVALS



## Standard Features

- High-speed 2.8 lines per second printing for 88 columns of print; 4.9 lines per second printing for 40 columns
- Single copy and up to five-part
- Wide slip capability of A4 size documents
- Functions in slave capacity, printing information sent via RS-232
- 5.2 in wide print area

# EPSON® TM-U590

Ticket Printer

## Part Number/Price

PART #	DESCRIPTION	WEIGHT	PRICE
68502	TM-U590 Ticket Printer, RS-232 with power supply, 115/230VAC	12lb	\$1,095.00
128726	TM-U590 Ticket Printer, RS-232 with European power supply, 115/230VAC	12lb	1,130.00
164391	TM-U590, USB, with 115/230VAC power supply	12lb	1,250.00

## Options/Accessories

PART #	DESCRIPTION	PRICE
68525	Ink cartridge (purple) ERC-31	\$12.00
104145	Ink cartridge (black) ERC-31B	12.00
23112	Power supply, US version PS-180	110.00
128746	Power supply, European version of PS-180	135.00
111840	Printer veil (protective cover)	65.00
68562	Additional operating manual	12.00
68725	Technical manual	35.00
72309	Power supply, 12VDC vehicle cigarette plug	185.00
<b>Cables</b>		
15568	25-Pin D-sub male to 25-Pin D-sub male RS-232 serial interface cable	65.00
15547	Blunt end, 25-Pin D-sub male RS-232 serial interface cable (Rice Lake indicators)	65.00
41279	25-Pin D-sub male to 9-Pin D-sub male, RS-232 with handshaking Interfaces to: Rice Lake indicators with a serial port screw terminal connection	65.00
32810	25-Pin D-sub male to 8-Pin D-sub male, RS-232 with handshaking Interfaces with DC-190, DC-100, DC-200, DC-300	65.00
Consult	Custom 20mA/RS-232 serial interface cable	100.00

Custom cables are designed to interface with your specific equipment. Please specify equipment model number and connector type.

Standard cable length is 5 feet. \$2.00 charge for each additional foot.

# EPSON® EU-T482 Series

Thermal Kiosk Printer

## Specifications

**Paper Width:**

79 mm standard ±5

**Paper Thickness:**

60-150 µm

**Paper Diameter:**

6 in (152.4 mm) outer max

8 in (203 mm) outer max

**Interface:**

USB complies with USB 2.0

RS-232 male D-Sub 9-Pin connector

**Autocutter:**

Full-cut

**Dimensions:**

7.64 x 6.7 x 14.72 in (194 x 170 x 374 mm)

**Weight:**

10 lb (4.5 kg)

**Print Method:**

Direct thermal single sheet

**Print Speed:**

6.0 in (153 mm) per sec

**Print Width:**

2.84 in (72 mm) adjustable

**Presenter Option:**

Friction feed

**Power Required:**

24VDC (PS-180 power supply)

**Environmental:**

Temperature 41°F to 122°F (5°C to 50°C)

Humidity 10 to 80% RH

**Sensors:**

Paper near end sensor

Auto cutter reset sensor

Print head temperature sensor

Platen open sensor

Black mark sensor

**Approvals:**

UL listed, CSA

**Warranty:**

One-year limited warranty



## APPROVALS



## Standard Features

- Modular design for easy mounting/integration
- Drop in paper loader
- RS-232 and USB interfaces
- Graphics printing
- Fast printing up to 6 inches per second
- All steel chassis

## Part Number/Price

PART #	DESCRIPTION	WEIGHT	PRICE
155751	EU-T482-011, embedded unit for kiosk vertical, (requires power supply)	13lb	\$1,170.00
23112	Power supply, PS-180		110.00

## Options/Accessories

PART #	DESCRIPTION	PRICE
105445	Paper 80 mm wide, 6 in O.D., 1 in core, 690 ft/roll, wound out	\$25.00
105446	Paper 80 mm wide, 8 in O.D., 1 in core, 1268 ft/roll, wound out	27.00
66535	Cable, 9-Pin female to 9-Pin female, null modem to PC, 6 ft	45.00
22436	Cable, comm 9-Pin D-subF to blunt end	55.00

# GoDEX® DT2/DT4/G500

Label Printer

## Specifications

### Print Speed:

DT2/DT4: 2 to 4 ips  
G500: 5 ips

### Print Length:

Minimum: 0.16 in  
Maximum: 68 in

### Print Width:

DT2: 2.12 in  
DT4/G500: 4.25 in

### Media:

Label roll O.D. max: 5.0 in

### Real Time Clock:

DT2/DT4: standard

### Core:

1 in, 1.5 in  
Thickness: 0.06 to 0.20 mm

### Ribbon (G500):

Core: 1 in  
Length: 300 m  
Max ribbon roll O.D.: 2.67 in  
Wide: 1.18 to 4.33 in

### Printer Language:

GZPL or GEPL

### Resident Fonts:

11 resident alphanumeric fonts (included OCR A and B) those are expandable eight times horizontally and vertically. All bit mapped fonts in eight orientations

### Bar Codes:

Code 39, Code 93, Code 128 (subset A, B, C,) UCC/EAN - 128 K-Mart, UCC/EAN - 128, UPC A/E (add on 2 and 5,) 2 of 5, EAN 8/13 (add on 2 and 5,) Codabar, Post Net, EAN 128, DUN 14, MaxiCode, HIBC, Plessey, Random Weight, Telepen, FIM, China Postal Code, RPS 128, PDF 417, Datamatrix code, QR Code

### Dimensions:

DT2: 8.58 L x 6.77 H x 3.94 in W (218 L x 172 H x 100 mm W)  
DT4: 8.58 L x 6.53 H x 6.61 in W (218 L x 166 H x 168 mm W)  
G500: 11.2 L x 6.8 H x 8.9 in W (285 L x 171 H x 226 mm W)

### Interfaces:

Baud rate 4800 to 115,200; DB9  
USB port U2.0

### Memory:

4 MB flash - DT2, 8 MB - DT4 and G500

### Power:

Auto switching 100/240VAC 50/60Hz

### Environment:

Operation: 41° F to 104° F (5° C to 40° C)  
Storage: -4° F to 122° F (-20° C to 50° C)

### Humidity:

Operation: 30 to 85 % non-condensing, free air  
Storage: 10 to 90% non-condensing, free air

### Approvals:

CE (EMC), FCC Class A, CB, CUL, CCC

### Warranty:

Two-year limited warranty



## APPROVALS



## Standard Features

- Auto language emulations GEPL, GZPL
- Free GoLabel design software for EZPL or Q Label
- 203 DPI (8 dot/mm)
- Drop in media loading
- USB or RS-232 interface
- Plain, gap label, black, mark or fanfold label
- Label length detection
- Direct thermal
- Model G500- direct thermal/thermal transfer
- 32 Bit CPU
- Tear bar

# GoDEX® DT2/DT4/G500

Label Printer

PRINTERS

## Part Number/Price

PART #	DESCRIPTION	WEIGHT	PRICE
132423	DT2 2 in direct thermal, time and date 10/240VAC printer	2.65 lb	\$345.00
132424	DT4 4 in direct thermal, time and date 110/240VAC printer	3.3 lb	395.00
132425	G500 4 in direct/thermal transfer, 110/240VAC printer	6 lb	585.00
<b>DT2</b>			
150738	Label peeler		35.00
150739	Cutter		210.00
150740	Print head		110.00
<b>DT4</b>			
150741	Label peeler		45.00
150742	Cutter		225.00
150743	Print head		195.00
107638	Guardian enclosure		1,150.00
<b>g500</b>			
150744	Label peeler		40.00
150745	Cutter		450.00
150746	Print head		195.00
107639	Guardian enclosure		1,150.00
<b>Cables For All Printers</b>			
41276	6 ft serial cable DB9 M to blunt end, (Rice Lake indicators)		65.00
79074	USB cable		30.00
64661	6 ft serial cable DB9 M to 8-Pin DIN		65.00
64660	6 ft serial cable DB9 M to DB9 male		65.00
Custom Pin	Custom RS-232 serial cable		100.00

## Options/Accessories

PART #	DESCRIPTION	PRICE
38941	Cleaning pen for open print head printers 12 per box	\$57.00
38794	Cleaning cards, 2 in W x 6 in L 25 per box for RL-22DT	50.00
35664	Cleaning cards, 4 in W x 6 in L for RL-42DT and RL-42TT	50.00
111085	Power supply, printers	158.00
<b>Label Stock/Ribbon</b>		
<b>DT2</b>		
110347	Direct thermal, 2.25 W x 1.25 in L, 5 in diameter with perf., 2100/roll	12.80/roll
40332	Direct thermal, 2.25 W x 2 in L, 5 in diameter with perf., 1445/roll	14.25/roll
110348	Direct thermal, 2.25 W x 3 in L, 5 in diameter with perf., 950/roll	13.50/roll
110349	Direct thermal, 2.25 W x 4 in L, 5 in diameter with perf., 700/roll	10.80/roll
65617	Direct thermal, 2.25 W x 4.5 in L, 5 in diameter with perf., 600/roll	14.60/roll
110346	Direct thermal, 1.20 in x 0.85 in L, 5 in diameter with perf., 2710/roll	8.25/roll
47761	Direct thermal, 2.5 W x 121 ft L, continuous 12 rolls/case	66.00/case
<b>DT4</b>		
53251	Direct thermal, 4 W x 3 in L, 5 in diameter with perf., 930/roll	23.35/roll
40331	Direct thermal, 4 W x 4 in L, 5 in diameter with perf., 745/roll	23.35/roll
37345	Direct thermal, 4 W x 6 in L, 5 in diameter with perf., 450/roll	20.00/roll
<b>G500</b>		
53261	Thermal transfer, 4 W x 3 in L, 5 in diameter with perf., 930/roll	18.05/roll
110536	Ribbon (black), 4.3 in wax/resin, 984 ft length	13.50/roll
110537	Ribbon (black), 2.5 in wax/resin, 984 ft length	4.50/roll

www.ricelake.com | Phone: 800-472-6703

RICELAKE



# Okidata 186 Turbo

Microline Printers

## Specifications

**Print Method:**

9-Pin (0.34 mm dia.) serial impact dot matrix

**Graphics Resolution:**

240 x 216 maximum

**Print Speed\* (CPS):**

NLQ: 62; Utility: 250; High Speed Draft: 333; Super Speed Draft: 375

**Feed Rate:**

2.0ips

**Emulations:**

IBM® 2480 Epson E6C/P or OKI® Microline®

**Interface:**

Parallel, USB or RS-232

**Compatibility:**

186/Windows® XP, 2000, 98/95

**Receive Buffer:**

1 line buffer

**Paper Input:**

Cut sheet, 7.2 in to 8.5 in W  
(182.9 mm to 215.9 mm W)  
Bottom feed with pull tractor option

**Number Of Copies:**

Five copies

**Pin Feed:**

Continuous, 9.5 in to 10.5 in wide (241.3 mm to 266.7 mm wide)

**Paper Thickness:**

0.014 in (0.35 mm) maximum

**Paper Path:**

Bottom, rear or top

**Paper Weight:**

Cut sheet 16 lb to 24 lb (7.2 kg to 10.8 kg),  
Continuous 16 lb to 20 lb (7.2 kg to 9.1 kg)

**Electrical:**

120VAC: ±10%; 220/240VAC: ±10%

**Power Consumption:**

Operating: 35W  
Idle: 7W

**Reliability (MTBF):**

70,000 hours (25% duty cycle, 35% page density)

**Print Head Life:**

200 million characters

**Ribbon Type:**

Black cartridge (2 million characters nominal life)

**Operating Temperature:**

40° F to 104° F (4° C to 40° C) at 25% to 80% relative humidity

**Overall Size:**

14.2 W x 10.8 D x 3.2 in H (360.7 W x 274.3 D x 81.3 mm H)

**Est. Ship Weight:**

10 lb (4.5 kg)

**Warranty:**

One-year limited warranty (includes print head)

\* Print speeds apply to all pitches (10, 12, 17.1, and 20 cpi)

\*\* Requires optional pull tractor (part #41224)



## Standard Features

- Vertical tabs
- Long-lasting, self-inking ribbon cartridge
- Bit image graphics for plotting charts, graphs and drawings
- Full ASCII character set
- Friction and adjustable pin feed paper handling
- 9-Pin, long-life print head
- RS-232 interface or parallel input
- Near letter-quality printing at 50 characters per second
- Superscripts, subscripts and underlining
- Bottom, rear or top feed

## Part Number/Price

PART #	DESCRIPTION	WEIGHT	PRICE
90969	Okidata 186 Turbo Printer with RS-232, 115VAC	10 lb	\$660.00

## Options/Accessories

PART #	DESCRIPTION	PRICE
20236	Tractor feed kit with friction rollers	\$88.00
20664	Ribbon cartridge black	8.00
21208	Protective dust cover	65.00
41364	Additional operating manual	35.00
<b>Cables</b>		
15547	Blunt end, 25-Pin D-sub male RS-232 serial interface cable (Rice Lake indicators)	65.00

# Okidata 320/390/420 Turbo

Microline Printers

## Specifications

### Print Method:

Okidata 320/420: 9-Pin (0.34 mm dia.) serial impact dot matrix  
Okidata 390: 24-Pin (0.20 mm dia.) serial impact dot matrix

### Graphics Resolution:

Okidata 320/420: 240 (H) x 216 (V) DPI maximum (Epson®/IBM®)  
Okidata 390: 360 (H) x 360 (V) DPI maximum (Epson/IBM AGM)

### Print Speed\*\* (cps):

Okidata 320: NLQ: 75; Utility: 300;  
High Speed Draft: 390;  
Super Speed Draft: 435  
Okidata 390: LQ: 105; Utility: 315;  
Super Speed Draft: 390 (15 cpi)  
Okidata 420: NLQ95;  
High Speed Draft: 5p 510; Utility: 570, Super 570

### Feed Rate:

5.0ips

### Emulations:

Okidata 320: Epson EX-PPR II and OKI® Microline®  
Okidata 390: Epson ESC/P2, IBM ProPrinter® and IBM AGM  
Okidata 420: Epson Fx IMB Pro Point Micro

### Interface:

Okidata 320/390/420: IEEE 1284 bidirectional parallel; Windows® 95 plug and play compatible, USB  
Okidata 390: Centronics® and IEEE 1284 bidirectional parallel

### Compatibility:

Windows® XP, 2000, 98/95

### Receive Buffer:

Okidata 320: 28K  
Okidata 390: 23K  
Okidata 420: 128K

### Code Pages:

Standard ASCII; Epson character set I and II; IBM character set I, I and AI; Code Page 850, 860, 863, 865, 437; BRASCI and ABICOMP

### Resident Fonts:

Okidata 390: LQ: Courier, Letter Gothic, Orator, Prestige, Roman and Swiss/Bold;  
Utility: Gothic

### Scaleable Fonts:

Okidata 320/420: Courier, Gothic (22-216 pt. in one pt. increments)  
Okidata 390: Courier, Roman and Swiss™ (8-64 pt. in one pt. increments)

### Bar Codes:

Code 39, UPC A, UPC E, EAN 8, EAN 13, Interleaved 2 of 5, Code 128 (A, B, C), PostNet™

### Paper Input:

Single/multi-part, continuous, cut sheet, envelopes, card stock, labels  
Bottom feed with pull tractor option

### Number Of Copies:

Okidata 320: Six  
Okidata 390: Four  
Okidata 420: Six

### Tractor:

3.5 to 10.5 in wide (88.9-266.7 mm wide), rear push with zero tear and paper park (optional)

### Paper Thickness:

Rear feed: 0.014 in (0.35 mm) maximum;  
Bottom feed\*\*\*: 0.017 in (0.43 mm) maximum, expandable to 0.01 in (.78 mm)

### Paper Path:

Bottom, rear or top

### Paper Weight:

Cut sheet 16 to 24 lb (7.2 to 10.8 kg), Continuous 16 to 20 lb (7.2 to 9.1 kg)

### Electrical:

115VAC, 230VAC

### Power Consumption:

Okidata 320: Operating: 100W  
Okidata 390: Operating: 43W Idle: 10W  
Okidata 420: 20,000 hours

### Reliability (MTBF):

10,000 hours (25% duty cycle, 35% page density)



Okidata 320 Turbo Microline

## Standard Features

- Vertical tabs
  - Long-lasting, self-inking ribbon cartridge
  - Bit image graphics for plotting charts, graphs and drawings
  - Full ASCII character set
  - Friction and adjustable pin feed paper handling
- Okidata 320/420 Turbo\*:**
- 9-Pin, long-life print head (parallel input)
  - Centronics®-compatible parallel interface
  - Near letter-quality printing at 63 characters per second
  - 80 column with standard character, 160 columns with condensed characters
  - Front access panel for quick and easy control of type size, print quality and other frequently used printer functions

### Okidata 390 Turbo:

- 24-Pin, long-life print head
- Supports Windows® 95/98
- Superior, professional quality printer
- Auto-tear accurately positions continuous forms for a clean tear at the perforation
- 3 scaleable fonts

\* Use with CBI

## Specifications Continued

### Print Head Life:

200 million characters

### Ribbon Type:

Black cartridge (2 million characters nominal life)

### Operating Temperature:

40° F to 104° F (4° C to 40° C) at 25% to 80% relative humidity

### Overall Size:

Okidata 320 and 390: 15.7 W x 13.6 x 4.6 in H (398.8 W x 345.4 D x 116.8 mm H)  
Okidata 420: 15.7 x 13.6 x 6.0 in

### Est. Ship Weight:

Okidata 320: 16 lb (7.2 kg)  
Okidata 390: 15 lb (6.8 kg)  
Okidata 420: 17 lb (7.7 kg)

### Warranty:

320/390: One-year limited warranty (includes print head)  
420: Three-year limited warranty

\*\* Print speeds apply to all pitches (10, 12, 17.1, and 20 cpi)

\*\*\* Requires optional pull tractor (part #41224)

# Okidata 320/390/420 Turbo

Microline Printers

## Part Number/Price

PART #	DESCRIPTION	WEIGHT	PRICE
126438	Okidata 320 Microline Turbo Printer with RS-232 interface, 115 VAC	16 lb	\$960.00
41222	Okidata 320 Microline Printer with parallel/USB interface, 115 VAC	16 lb	790.00
41223	Okidata 320 Microline Printer with parallel/USB interface, 230 VAC	16 lb	790.00
75106	Okidata 390 Microline Turbo Printer with parallel/USB interface, 115 VAC	15 lb	810.00
102959	Okidata 420 Microline Turbo Printer with parallel/USB interface, 115 VAC	16 lb	825.00

## Options/Accessories

PART #	DESCRIPTION	PRICE
<b>Cables</b>		
15547	Blunt end, 25-Pin D-sub male RS-232 serial interface cable (Rice Lake indicators)	\$65.00
<b>320/420 Turbo Options and Accessories</b>		
41224	Pull tractor kit for bottom-fed continuous forms and push/pull operation	98.00
20239	RS-232 input board, older revisions	170.00
121454	RS-232 option board, 320 Rev 10	170.00
20664	Ribbon cartridge black, 320 and 390	8.00
132249	Ribbon cartridge for 420	8.00
21226	Protective dust cover	65.00
41363	Additional operating manual	35.00
75107	Cut sheet feeder	490.00
<b>390 Turbo Options and Accessories</b>		
75107	Cut sheet feeder	490.00
20239	RS-232 option board, older version	170.00
41224	Pull tractor kit for bottom-fed continuous forms and push/pull operation	98.00
20664	Ribbon cartridge black	8.00

*Standard unit has pins on roller for holes on paper*

*Interfaces to: Rice Lake indicators with a serial port screw terminal connection*

# Printek MtP400si

Mobile Printer

## Specifications

### Print Method:

Direct thermal

### Resolution:

203 DPI (8 dots per mm)

### Print Speed:

Up to 3.3 ips

### Width:

Up to 4.1 in (10.41 cm)

### Fonts:

A wide range of font types and sizes, from 6 cpi to 34 cpi depending on emulation chosen, plus scaling

### International Characters:

An expanding catalog available for download. Bar Codes: 39, 128, Intlv 2 of 5, EAN08 and 13, PDF-417 and UPC, depending on emulation chosen.

Downloadable fonts, graphics, logos and additional bar codes

### Connectivity:

RS-232

### Software:

Drivers and Utilities: Drivers for WIN 98, 2000, XP. compatible with Windows® CE/ Pocket PC and Palm OS print utilities and SDK's.

Printer Setup program provides convenient configuration via a Windows interface from any computer

### Emulations:

Emulates many popular printer brands and languages including O'Neil, Zebra CPCL and ZPL, Extech, IPL, MPL, E-Sim and Printek Mt3. Can be upgraded as new emulations become available.

### Ingress Protection Rating:

IP54

### Print Media:

Paper Type: Direct thermal roll, fan fold media and label media

Roll Size: Maximum roll diameter 2.625 in (6.7 cm) allows roll widths from 3 in to 4.125 in (7.6 to 10.5 cm)

Roll Capacity: Approximately 171 ft (52.1 cm) max.

Core Size: 0.75 in (1.9 cm)

### Electronics/Power:

Ruggedized screw down-type DB-9 connector for power and I/O.

DC Input: 8 to 32 VDC

Overvoltage Protection: 80 VDC for 1 hour. Failsafe to 180 VDC.

I/O Short Circuit: Tolerant of shorts to ground or DC input.

### Dimensions:

7.7 L x 6.6 W x 3.1 in H (19.56 x 16.76 x 7.87 cm)

### Weight:

2.0 lb (0.90 kg)

### Memory:

2 MB Flash, 1 MB SRAM. Standard memory supports large and graphic intensive print jobs

### Operating Temperature:

-40°F to 185°F (-40°C to 85°C)

### Operating Humidity:

10% to 90% RH (non-condensing)

Rated IP54 per IEC529

Chemical resistant case per SAEJ1455

### Operator Controls And Indicators:

4 illuminated icons for general fault, wireless connection, MCR ready and battery status.

2 line LCD for system alerts and messages, configuration setup and battery charge

Buttons for power, paper feed and setup menu.

Sensors for paper out, black mark detection, and door open.

### Durability And Reliability:

Survives multiple 4 foot drops to concrete (each face) and conforms to IEC 68-2

### Vibration Resistance:

9.8 frms 24 to 2000 Hz

MTBF: 10,000 hours in normal use

### Approvals:

FCC Class B, CE mark, UL listed AC adapters, E-mark on In-Vehicle adapters

### Warranty:

One-year printer warranty on the entire printer—case and print head included



## APPROVALS



FCC  
NRTL

## Standard Features

- Designed for superior resistance to impact and harsh chemicals
- IP54 rated for water and dust resistance
- Rugged, screw down connector for power and data
- Simple drop-in paper loading
- Direct thermal printing
- Wide input voltage range and superior circuit protection
- On-Board Weighing, Forklift applications
- Data/Power Cable and one roll of paper supplied with printer
- Printek printers are made in the USA

## Part Number/Price

PART #	DESCRIPTION	WEIGHT	PRICE
115527	MtP400si, 4 in direct thermal printer, IP54, RS232	2 lb	\$1,345.00

## Options/Accessories

PART #	DESCRIPTION	PRICE
115528	Paper roll, thermal 4.125 in wide, 1.625 OD, .75 in core	\$6.00
115529	Universal ball-mount	24.00
118713	Uncoiled data/power cable	75.00

# Star Nippon® NP-211/NP-2511/NP-3511

Thermal Kiosk Printer

## Specifications

### Paper Width:

NP-211/NP-2511: 58 mm  
NP-3511: 80 mm

### Print Method:

Direct Thermal

### Paper Roll Diameter (max):

70 mm

### Paper Thickness:

NP-3511 65 to 150 µM

### Print Width:

NP-211: 54 mm  
NP-2511: 58/60 (mm)  
NP-3511: 65/70/80/82.5 mm

### Resolution:

203 DPI (8 dots/mm)

### Print Speed:

NP-211: 50 mm/sec  
NP-2511/NP-3511: 200 mm/sec

### Interface:

Serial and USB

### Bar Codes:

NP-211/NP-3511: UPC-A, UPC-E,  
EAN (JAN-13) CODE39, ITF,  
CODEABAR, CODE128

### Cutter:

NP-211: Tear bar  
NP-2511/NP-3511: Full and partial-cut (command selectable)

### Power Supply:

NP-211: DC 8-13V  
NP-2511/NP-3511: DC 24V

### Input Buffer:

10K Bytes

### Operating Voltage:

8-13V DC +/-5%

### External Dimensions (W x D x L):

NP-211: 84 x 115 x 77.5 mm  
NP-2511/NP-3511: 115 x 150 x 75 mm

### Reliability Head Wear:

50 km



## Standard Features

### NP-211

- Tear bar
- Compact footprint
- Semi-auto paper loading

### NP-2511/NP-3511

- Lock-free cutter
- Easy operation by openable head
- Operating temp: 14°F to 140°F (-10°C to 60°C)
- Max paper thickness: 150 micrometer
- Low profile (96.7 mm with roll paper)

## Part Number/Price

PART #	DESCRIPTION	WEIGHT	PRICE
102953	NP-211D, 2 in wide, requires power supply	2lb	\$500.00
103143	NP-2511, 2 in wide, requires power supply	2lb	725.00
103144	NP-3511, 3 in wide, requires power supply	2lb	800.00

## Options/Accessories

PART #	DESCRIPTION	PRICE
102955	Power supply, PS-NP, NP-211	\$75.00
69903	Power supply, NP-2511, NP-3511	100.00
107835	Large paper roll holder, NP-3511	120.00
<b>Paper roll</b>		
102957	58 mm (2.28 in) thermal, NP-211, NP-2511, 2 3/4 outer diameter	3.50
69917	80 mm (3.125 in) thermal, NP-3511, 3 1/4 outer diameter, 295 feet	5.00
105445	80 mm (3.125 in) thermal, 690 ft, 6 in O.D., use with 107835	25.00

# Star® Micronics SP298

Dot Matrix Ticket Printer

## Specifications

**Print Speed:**

3.1 lines per second (13 mm/sec)

**Print Width:**

2.5 in (63 mm)

**Line Spacing:**

1/6 in, N/144 in Star line mode, 1-60 in-ESC/POS™ mode

**Print Head:**

9-Pin

**Number Of Columns:**

42

**Print Direction:**

Bidirectional

**Paper Width:**

3.15 in to 7.17 in (80 mm to 182 mm)

**Paper Thickness:**

0.004 in to 0.008 in (0.09 mm to 0.2 mm)

**Copy Capabilities:**

One original and two copies

**Paper Sensors:**

Top and bottom of form

**Ribbon:**

Cassette-type purple ribbon. Ribbon life is approximately 2.2 million characters (continuous print)

**Printer Reliability:**

9 million lines MCBF (CRT)

**Print Head Reliability:**

70 million characters

**Interface:**

RS-232 serial interface

**Data Buffer:**

Star mode: 2KB or 35 bytes ESC/POS mode: 512 bytes or 35 bytes

**Emulation:**

Star mode, ESC/POS™ (TM-U295/TM290)

**Cash Drawer:**

Two drivers plus compulsion sensor

**Drivers:**

Windows® 95/98/2000/NT 4.0, OPOS, JavaPOS™

**Operating Temperature:**

41° F to 104° F (5° C to 40° C)

**Humidity:**

10% to 80% RH

**Overall Dimensions:**

7.09 W x 7.48 H x 7.48 in D (180 W x 138 H x 190 mm D)

**Approvals:**

UL and C-UL listed, TUV

**Warranty:**

Three-year limited warranty on parts

One-year limited warranty on print head



## APPROVALS



## Standard Features

- Top and bottom paper sensing
- AutoSide Loading™ for quick and easy document loading
- Bidirectional serial impact printer capable of printing graphics using a highly reliable 9-Pin print head
- Up to 3.1 lines per second printing with bidirectional check mode
- Epson® TM-U295/TM290 compatible with same size footprint and interchangeable power supply, easier paper and ribbon loading
- Single or up to three-part multi-copy ticket printing
- Cash drawer driver

# Star® Micronics SP298

Dot Matrix Ticket Printer

## Part Number/Price

PART #	DESCRIPTION	WEIGHT	PRICE
69901	SP298 Ticket Printer with RS-232 and power supply, 115/230VAC (gray)	9 lb	\$600.00
69902	SP298 Ticket Printer with RS-232, 24VDC (gray) without power supply	9 lb	590.00

## Options/Accessories

PART #	DESCRIPTION	PRICE
69921	Ink ribbon (purple)	\$12.00
69903	Power supply, PS-60-24A	100.00
72309	Power supply, 12VDC with cigarette plug (also works with TM-U295)	185.00
72471	Star programmer's CD	11.00
<b>Cables</b>		
15547	Blunt end, 25-Pin D-sub male RS-232 serial interface cable (Rice Lake indicators)	65.00
15568	25-Pin D-sub male to 25-Pin D-sub female RS-232 serial interface cable	65.00
72440	25-Pin to 9-Pin, D-sub female cable	65.00

USB and Parallel versions available for quote

# Star® SP512/SP542/SP712/SP742

Dot Matrix Printers

## Specifications SP512/SP542

**Print Method:**

9-Pin impact dot matrix

**Print Speed:**

4 lines per second at 40 columns  
8 lines per second at 16 columns

**Number Of Columns:**

42 at 16.9 cpi

**Paper Width:**

2.25 in/3 in (selectable)

**Paper Thickness:**

0.002 in to 0.003 in (0.07 to 0.10 mm)

**Copy Capabilities:**

Copies: original and two copies, maximum 0.007 in (0.20 mm)

**Roll Diameter:**

3.34 in (85 mm)

**Paper Roll Core:**

0.47 in (12 mm) ID, 0.70 in (18 mm) OD

**Paper Loading:**

Semi-automatic

**Paper Sensors:**

Paper out

**Cutter Reliability:**

0.5 million cuts

**Printer Reliability:**

70 million characters

**Auto Cutter:**

SP542: full and partial cut (software controlled)

**Interface:**

RS-232 serial

**Baud Rates:**

4,800, 9,600, 19,200, 38,400

**Drivers:**

Windows® 9x/NT/2000, OPOS, JavaPOS™

**Emulation:**

Star Mode, ESC/POS™

**Cash Drawer:**

2 drivers, 1 compulsion switch

**Power Required:**

100 to 240 VAC, 50/60 Hz

**Overall Dimensions:**

5.51 W x 8.85 D x 6.41 in H (140 W x 225 x 163 mm H)

**Storage Temperature:**

10% to 90% RH

**Operating Temperature:**

3° F to 104° F (0° C to 40° C)

**Approvals:**

UL and C-UL listed, TÜV

**Warranty:**

Three-year limited warranty on parts  
One-year limited warranty on print head and cutter



## APPROVALS



## Standard Features

- Spill-proof cover
- Single-color highlights
- Power switch cover
- Internal universal power supply
- Serial interface
- Star and ESC/POS emulation
- Black mark sensor
- More than 4 lines per second print speed
- Auto cutter and tear bar versions
- Prints multiple copies (original and two copies)
- High reliability
- Prints graphics

### SP712 Only

- Clamshell design for easy paper loading
- Spill-proof and heat-resistant
- Swappable interfaces available
- Wall mount (option)
- External buzzer option

## Specifications SP712/SP742

**Print Method:**

9-Pin impact dot matrix

**Print Speed:**

13 RPM

**Paper Width:**

70 and 58 mm (with paper guide)

**Emulation:**

Star mode, ESC/POS

**Power:**

110 to 230 VAC

**MCBF:**

22 million lines

**Cutter:**

1 million cuts

**Dimensions:**

160 W x 152 H x 245 mm D

**Connectivity:**

9-Pin serial, 25-Pin serial, parallel, USB, ethernet, Wifi

**Drivers:**

2000 XP (L), XP embedded (L), VISTA (G) (32-and 64-bit)

**Warranty:**

Three-year limited warranty



# Star® SP512/SP542/SP712/SP742

Dot Matrix Printers

## Part Number/Price

PART #	DESCRIPTION	WEIGHT	PRICE
77167	SP512 dot matrix tape printer, with tear bar, RS-232 serial interface	5lb	\$325.00
85911	SP512 dot matrix tape printer with tear bar, parallel interface	5lb	325.00
77168	SP542 dot matrix tape printer, with auto cutter, RS-232 serial interface	5lb	400.00
103141	SP712 RS-232 tape printer, tear bar	9lb	350.00
155825	SP712 RS-232 tape printer, tear bar, journal	9lb	425.00
164392	SP712, USB tape printer, tear bar	9lb	390.00
103142	SP742 RS-232 tape printer, cutter	9lb	490.00

Consult factory for models with a parallel interface.

## Options/Accessories

PART #	DESCRIPTION	PRICE
69921	Ink ribbon (purple) SP500, SP2000, SP200, series	\$12.00
103728	Ink ribbon (black), SP700 Series	12.00
69916	One-ply paper roll, 3 in W x 3 in Dia. 150 ft roll, Bond, 3 in OD	5.00
69915	Two-ply paper roll, 3 in W x 3 in Dia. white/canary yellow, 90 ft roll, 3 in OD	7.00
72471	Programmers CD-ROM (includes utility programs and manuals)	11.00
121331	Wall mount bracket, SP700 Series	30.00
<b>Cables</b>		
15547	Blunt end, 25-Pin D-sub male RS-232 serial interface cable (Rice Lake indicators)	65.00
15568	25-Pin D-sub male to 25-Pin D-sub male RS-232 serial interface cable	65.00
72440	25-Pin to 9-Pin D-sub female cable	65.00
79074	USB cable	30.00

# Star® DP8340

Dot Matrix Tape Printer

## Specifications

**Number Of Print Columns:**

40 columns, 12 CPI

**Print Speed:**

Approximately 2 lines/sec

**Print Direction:**

Bidirectional

**Line Spacing:**

1/6 in

**Paper Feed Method:**

Friction Feed or Sprocket-feed

**Paper Feed Speed:**

Approximately 12 lines/sec

**Character Set:**

ASCII: 96 characters; International and symbol: 64 characters;  
Block graphics: 64 characters

**Font Configuration:**

Ordinary characters: 5 x 9 dots; Block graphics: 6 x 6 dots

**Character Size:**

0.09 in H x 0.06 in W (2.42 mm H x 1.71 mm W)

**Dot Spacing:**

0.01 in H x 0.01 in W (0.35 mm H x 0.35 mm W)

**Print Area:**

3.31 in (84.3 mm)

**Print Buffer:**

Approximately 1.5 KB

**Serial Interface:**

RS-232, 150 to 9600 baud

**Power Supply Unit:**

115/230VAC, 12VDC output

**Paper Type:**

Ordinary and carbonless copy paper

**Paper Width:**

4.5 in (114.3 mm)

**Roll Diameter:**

80 mm outer diameter (Max)

**Paper Thickness:**

Maximum 0.09 mm

**Copy Capabilities:**

One copy plus one original: 0.005 in (max 0.13 mm)

**Paper End:**

Paper should not be attached to the core

**Ribbon Color:**

Black and red

**Ribbon Material:**

Nylon (#40 denier)

**Ribbon Size:**

0.5 in x 20 ft (13 mm x 6 m)

**Spool:**

Width: 0.5 in (13 mm); Diameter (two spool): 1.3 in (35 mm)

**Operating Temperature:**

41° F to 104° F (5° C to 40° C)

**Operating Humidity:**

10% to 80% RH

**Storage Temperature:**

-4° F to 158° F (to 20° C to 70° C)

**Storage Humidity:**

5% to 95% RH, 104° F (+40° C)

**Head Life:**

70 million characters

**Printer Reliability:**

5.0 million lines MCBF (except head life)

**Approvals:**

UL listed, CSA approved

**Warranty:**

Three-year limited warranty on parts; One-year limited warranty on print head



## APPROVALS



## Standard Features

- Separate 115/230VAC power supply with 12VDC output
- Two-color printing using two-color ribbon
- Cash drawer driver
- One line validation
- Wide paper

# Star® DP8340

Dot Matrix Tape Printer

## Part Number/Price

PART #	DESCRIPTION	WEIGHT	PRICE
70906	DP8340 dot matrix printer, RS-232 with friction feed and power supply	10 lb	\$670.00
70907	DP8340 dot matrix printer, RS-232 with friction feed, printer only	10 lb	640.00
70680	DP8340 dot matrix printer, RS-232 with paper sprocket, power supply, 115/230VAC	10 lb	670.00
70681	DP8340 dot matrix printer, RS-232 with paper sprocket, printer only	10 lb	640.00

## Options/Accessories

PART #	DESCRIPTION	PRICE
70682	Power supply, 115VAC	\$129.00
70683	Paper roll sprocket, 4.5 in (114 mm) W x 3 in dia., 140 ft roll	11.00
20448	One-ply paper roll, 4.5 in (114 mm) W x 3 in dia., 165 ft roll	8.00
42672	Two-ply paper roll, 4.5 in (114 mm) W x 3 in dia., 95 ft roll	7.00
71214	One-ply plain paper, 3.25 in W x 3 in dia., 50 rolls/case	95.00/case
20447	Ribbon cartridge (purple)	10.00
<b>Cables</b>		
72697	RJ-45 to RJ-45 cable	35.00
105151	RJ-45 to 9-Pin female cable	65.00

# Star® TSP 847

Receipt Thermal Printer

## Specifications

**Print Speed:**

1200 dots per second (150 mm/sec)

**Print Width:**

Max 104 mm

**Resolution:**

203 DPI

**Bar Codes:**

Yes

**Roll Paper:**

Paper width 111.5 mm (4.4 in)

Thickness 65 to 150

Diameter 4 in

**Emulation:**

Star, DP8340

**Drivers:**

Windows® 9X, 2000, XP, Linux, OPOS, JPOS,

Mac OS X™

**Operating Temperature:**

41° F to 113° F (5° C to 45° C)

**Overall Dimensions:**

7 W x 8.4 D x 5.8 in H (180 W x 213 D x 148 mm H)

**Approvals:**

RoHS compliant

**Warranty:**

Three-year limited warranty



## Standard Features

- Direct Thermal
- Small desktop footprint
- Jam-proof patented cutter with full or partial cut
- Wide area printing
- Zoom master drive allows letter-sized documents to be printed in 4.4 format
- Logo store capability

## Part Number/Price

PART #	DESCRIPTION	WEIGHT	PRICE
107617	TSP847D-24 line receipt printer (requires power supply)	5 lb	\$625.00

## Options/Accessories

PART #	DESCRIPTION	PRICE
69903	Power supply, PS-60-24A	\$100.00
72309	Power supply, 12VDC with car adaptor	185.00
107618	Thermal paper 4.4 in wide, 4 in OD	10.50
<b>Cables</b>		
15547	Blunt-end 25 pin D-sub male RS-232	65.00
15568	25-Pin D-sub male to 25 pin D-sub male RS-232 serial interface cable (Rice Lake indicators)	65.00
72440	25-Pin male to 9-Pin female	65.00

# Star® TSP654II/TSP743 II

Direct Thermal Printers

## Specifications

### Print Speed:

TSP654: 300 mm per second, 60 RPM

TSP743: 7 in (177.8 mm) per second, 60 lines per second at 3 mm per line (180 mm/sec)

### Print Width:

TSP654: 80 mm paper: 2.83 in (80 mm) 58 mm paper: 2.05 in (52 mm)

TSP743: Standard: 2.83 in (80 mm) Optional: 2.05 in (52 mm), 3.15 in (80 mm)

### Line Spacing:

3 mm, 4 mm (1/8 in, 1/6 in)

### Resolution:

203 DPI (8 dots/mm)

### Number Of Columns:

TSP654: 80 mm paper: 24, 48 or optional 64 (ESC/POS) 58 mm paper: 17, 34 or optional 46 (ESC/POS)

TSP743: Standard: 48, 71 (maximum)

### Bar Codes:

TSP654: UPC-A/E, JAN/EAN-8/13, Code 39/93/128, Codabar (NW7), ITF

TSP743: UPC-A/E, JAN/EAN-8/13, Code 39/93/128, Codabar (NW7)

### Paper Width:

Adjustable. Standard: 3.15 in (80 mm) Optional: 2.28 in (58 mm)

TSP743 Optional: 3.25 in (82.5 mm)

### Paper Thickness:

TSP654: 0.002 in to 0.003 in (0.065 mm to 0.085 mm)

TSP743: 0.003 in to 0.006 in (0.065 mm to 0.150 mm)

### Roll Diameter:

3.5 in (90 mm)

### Paper Roll Core:

1/2 in to 1.00 in (12 mm to 25.4 mm)

### Paper Path:

TSP654: Internal roll

TSP743: Slot in rear or internal roll

### Paper Loading:

"Drop-in and print" and external rear feed

### Paper Sensors:

TSP654: Near end, paper out, cover open

TSP743: Near end, paper out, top of form

### Printer Reliability:

60 million lines MCBF (CRT)

### Cutter Reliability:

TSP654: 0.5 million cuts

TSP743: 2 million cuts

### Data Buffer:

8K bytes

### Logo Store:

TSP654: 2M bit

TSP743: 4M bit

### Emulation:

Star line mode, ESC/POS™ (TM-U295/TM290)

### Cash Drawer:

Two drivers and one compulsion sensor

### Auto Cutter:

Full and partial cut

### Drivers:

Windows® 95/98/2000/NT 4.0, Windows® legacy printer, OPOS, JavaPOS™, Star Raster Graphics Mode, Linux

### Operating Temperature:

41° F to 113° F (5° C to 45° C)

### Humidity:

10% to 90% RH (with out condensation)

### Overall Dimensions:

TSP654: 5.59 W x 5.16 H x 7.83 in D (142 W x 131 H x 199 mm D)

TSP743: 5.79 W x 5.83 H x 8.39 in D (147 W x 148 H x 213 mm D)

### Approvals:

UL and C-UL listed, FCC, TUV

### Warranty:

Three-year limited warranty on parts

One-year limited warranty on print head and cutter



TSP654

TSP743

## APPROVALS



FCC  
NRTL

## Standard Features

- 203 DPI (8 dots/mm) print resolution
- Two-color printing (software enabled)
- Small footprint
- Easy load "drop-in and print" paper loading
- Adjustable paper width
- Logo store utility for easy logo data
- Cash drawer driver
- Cutter
- Easy to change "cartridge-type interface" RS-232 to Parallel
- Swappable communication interface

### TSP743:

- Label printing

# Star® TSP654II/TSP743 II

Direct Thermal Printers

PRINTERS

## Part Number/Price

PART #	DESCRIPTION	WEIGHT	PRICE
69910	TSP654II Direct Thermal, RS-232 with power supply, 115/230VAC, wall mount bracket	7 lb	\$460.00
69907	*TSP743II Direct Thermal Transfer, RS-232 with power supply, 115/230VAC	8 lb	600.00
69908	*TSP743II Direct Thermal Transfer, RS-232 only, 24VDC	8 lb	590.00
85929	*TSP743II Direct Thermal, Parallel without power supply	8 lb	590.00

\* If using for labels with black mark, request printer to be configured by Rice Lake Weighing Systems

## Options/Accessories

PART #	DESCRIPTION	PRICE
<b>TSP654</b>		
69903	Power supply, PS-60-24A	\$100.00
69917	One-ply thermal paper roll, 3.125 in W x 3.25 in diameter	5.00
107041	MaxStick receipt paper for TSP654 3 1/8 wide 150 ft long adhesive strip	18.75
72309	Power supply, 12VDC with vehicle cigarette lighter	185.00
71355	Parallel cartridge option	60.00
<b>TSP743</b>		
69919	Wall mount bracket	80.00
70598	Label, DTL, 3 in W x 1 in L, 4 in diameter, with black line timing mark 1600 labels/roll	22.00
70597	Label, DTL, 3 in W x 2 in L, 4 in diameter, with black line timing mark 900 labels/roll	22.00
72471	Star programmer's CD	11.00
<b>Cables</b>		
15547	Blunt end, 25-Pin D-sub male RS-232 serial interface cable, (Rice Lake indicators)	65.00
15568	25-Pin D-sub male to 25-Pin D-sub male RS-232 serial interface cable	65.00
72440	25-Pin to 9-Pin D-sub female cable	65.00

www.ricelake.com | Phone: 800-472-6703

RICE LAKE

760

# Zebra® LP/TLP 2824 Plus

Thermal Printer

## Specifications

**Resolution:**

203 DPI (8 dpmm)

**Print Length:**

0.005 to 39.0 in (0.125 to 991 mm)

**Print Width:**

0.005 to 2.2 in (0.125 to 56 mm)

**Print Speed:**

2 to 4 inches per second (ips)

**Media Specifications:**

Width: 1.00 to 2.36 in (25 to 60 mm)

**Label Length:**

Minimum: 0.38 in (9.7 mm)

1.0 in with optional cutter

Maximum 39 in (991 mm)

Inner Core: 1.0 in

Max roll diameter: 5 in

Sensing: gap, black line, notch

Type: roll-fed, fan fold, die cut or continuous with or without black mark, tag stock

**Communication Specifications:**

Centronics parallel (option)

RS-232 serial and USB

10/100 ethernet (option)

**Power:**

100-240 VAC, 50-60 Hz, US power cord

**Operating Temperature:**

-40°F to 105°F (-40°C to 40.5°C)

**Dimensions:**

4.37 x 8.5 x 6.75 in (111 x 216 x 171.5 mm)

**Weight:**

2.7 lb

**Warranty:**

One-year limited warranty



## Standard Features

- Print speeds of 4 in/sec (102 mm)
- 203 DPI print resolution (8dots/mm)
- Open ACCESSSTM design for easy media loading
- Direct thermal (LP) and (optional) thermal transfer (TLP) printing of bar codes, text and graphics
- Fully enclosed 5.0 in (127 mm) media compartment
- Double-walled ABS case construction
- EPL and ZPL® programming language, co-resident
- 32-bit RISC processor
- 8 MB SDRAM, 4 MB flash memory
- Zebra E3 print head energy control
- Auto-calibration of media
- Five resident expandable EPL2® fonts
- Auto-switching 100V and 240V power supply
- Linear and 2-D bar code symbologies
- Transmissive and reflective media sensing
- Head-up sensor
- Tear-off mode
- Certified Microsoft® Windows® drivers
- Line mode LP only

## Part Number/Price

PART #	DESCRIPTION	WEIGHT	PRICE
112874	LP2824 Plus Printer, 203 DPI, direct thermal, USB and Serial 120 VAC US power cord	6.0 lb	\$395.00
112875	TLP2824 Plus, 203 DPI, thermal transfer/direct, USB and Serial, 120 VAC US power cord	6.0 lb	495.00

Parallel and Ethernet models available by special request

## Options/Accessories

PART #	DESCRIPTION	PRICE
38941	Cleaning pens for open print head printers, 12/box	\$57.00
38794	Cleaning cards 2 in W x 6 in L, 25/box	50.00
<b>Label Stock/Ribbon</b>		
110346	Direct thermal, 1.2 in W x .85 in L, 5 in diameter with perf., 2700/LPR	8.25/roll
110347	Direct thermal, 2.25 in W x 1.25 in L 5 in diameter with perf., 2100/LPR	12.80/roll
40332	Direct thermal, 2.25 in W x 2 in L, 5 in diameter with perf., 1445/LPR	14.25/roll
110348	Direct thermal, 2.25 in W x 3 in L, 5 in diameter with perf., 950/LPR	13.50/roll
110349	Direct thermal, 2.25 in W x 4 in L, 5 in diameter with perf., 700/LPR	10.80/roll
65617	Direct thermal, 2.25 in W x 4.5 in L, 5 in diameter with perf., 600/LPR	14.60/roll
<b>Cables</b>		
41276	Serial cable 6 ft (DB9 male to blunt end) (Rice Lake indicators)	65.00
79074	USB cable, 6 ft	30.00
64794	DB9 RS-232 cable DB9F to DB9M	65.00

# Zebra® GK Series

Label Printer

## Specifications

**Paper Width:**

0.75 to 4.25 in (19 to 108 mm)

**Paper Thickness:**

0.003 to 0.0075 in (0.08 to 0.19 mm)

**Paper Diameter (OD):**

5 in (127 mm)

**Paper Roll Shaft:**

1 in (standard)

**Resolution:**

203 DPI/8 dots per mm;

**Memory:**

Standard: 4 MB flash; 8 MB SDRAM

**Print Width:**

4.09 in (104 mm)

**Bar Code Symbologies:**

Bar code ratios: 2:1 (non-rotated) and 3:1

Linear bar codes: Codabar, Code 11 (ZPL),

Code 128, Code 39, Code 93, EAN-13, EAN-8, EAN-14 (ZPL), German Post Code (EPL), Industrial 2-of-5 (ZPL), Interleaved 2-of-5, Japanese Postnet (EPL), ISBT-128 (ZPL), Logmars (ZPL), MSI, Plessey, Postnet, GS1 DataBar (RSS-14), Standard 2-of-5 (ZPL), UCC/EAN-128 (EPL), UPC and EAN 2 or 5 digit extensions (ZPL), UPC-A, UPC-A and uPC-E with EAN 2 or 5 digit extensions, UPC-E, and GS1 DataBar (formerly RSS)

Two-Dimensional: Codablock (ZPL), Code 49 (ZPL), Data Matrix, MaxiCode, QR Code, MicroPDF417, Aztec

For EPL and ZPL except where noted

**Maximum Print Length:**

39.0 in (990 mm)

**Maximum Print Speed:**

GK420: 5 in (127 mm) per second

**Media Sensors:**

Standard: fixed reflective

**Transmissive Sensors:**

Optional: adjustable reflective black line sensor

GX models

**Ribbon Outside Diameter:**

1.36 in (35 mm)

**Ribbon Standard Length:**

244 ft (74 m)

**Ribbon Ratio:**

1:1 media to roll to ribbon

**Ribbon Width:**

133 to 43 in (33.8 to 109.2 mm)

**Ribbon Core Inner Diameter:**

0.5 in/12.7 mm

**Serial:**

DB9

**USB:**

U1.1, Bidirectional

**Operating Characteristics:**

Operating Temperature: 40° F to 105° F (41° C to 4.4° C)

Storage temperature: -40° F to 140° F (-40° C to 60° C)

Operating humidity: 5% to 95 % non-condensing

Storage humidity: 5% to 95 % non-condensing

**Electrical:**

Auto-detectable (PFC compliant) 100-240 VAV, 50-60 Hz

**Physical Characteristics:**

Direct thermal:

6.75 W x 6 H x 8.25 in D

(171 W x 152 H x 210 mm D)

Weight: 3 lb

Thermal Transfer:

7.6 W x 7.5 H x 10 in D

(193 W x 191 H x 254 mm D)

Weight: 5 lb



## Standard Features

- Print width: 4.09 in
- 5 in per second print speed
- 203 DPI
- USB, RS-232 interface, parallel (optional Ethernet models available)
- Auto sense EPLZ or ZPL
- Tear bar

## Options

- Models available with peeler
- Models available with Ethernet



# Zebra® GK Series

Label Printer

## Part Number/Price

PART #	DESCRIPTION	WEIGHT	PRICE
<b>Direct Thermal</b>			
107309	GK420d, 110/240VAC	10 lb	\$595.00
163193	GK420d, Peeler option	10 lb	630.00
163195	GK420d, Ethernet	10 lb	744.00
<b>Thermal Transfer</b>			
107321	GK420t, 110/240VAC	10 lb	695.00
163194	GK420t, Peeler option	10 lb	730.00
163196	GK420t, Ethernet	10 lb	844.00

## Options/Accessories

PART #	DESCRIPTION	PRICE
93181	Film, print head, cleaning 4 in wide, 3/box	\$18.00
35664	Cleaning cards, pre-saturated, 4 in W x 6 in L, 25/box	50.00
<b>Label Stock/Ribbon</b>		
40332	Direct thermal, 2.25 in W x 2 in L, 5 in diameter with perf., 1445/roll	14.25/roll
53251	Direct thermal, 4 in W x 3 in L, 5 in diameter with perf., 930/roll	23.35/roll
40331	Direct thermal, 4 in W x 4 in L, 5 in diameter with perf., 745/roll	23.35/roll
37345	Direct thermal, 4 in W x 6 in L, 5 in diameter with perf., 450/roll	20.00/roll
47761	Direct thermal, 2.5 in W x 121 ft L, continuous 12 rolls/case	66.00/case
53261	Thermal transfer, 4 in W x 3 in L, 5 in diameter, 930/roll	18.05//roll
75895	Ribbon (black), 4.3 in wax/resin, 244 ft	9.75/roll
81212	Ribbon (black) 2.5 in wax, 244 ft	6.65/roll
<b>Cables</b>		
37528	6 ft serial cable, DB9 male to DB9 female	35.00
37527	6 ft parallel cable	35.00
41276	6 ft serial cable, DB9 male to blunt end, (Rice Lake indicators)	65.00
79074	USB cable 6 ft	30.00
64661	5 ft serial cable, DB9 male to 8 pin DIN, Interfaces to DC-190	65.00
64660	5 ft serial cable, DB9 male -DB9 male with handshaking	65.00
<b>Print Head</b>		
111091	Print head, 203 DPI, GK direct thermal only	200.00

# Zebra® RW 420/RW 220

Thermal Portable Printer

## Specifications

### Printer Specifications:

Resolution: 203 DPI (8 dots/mm)  
Memory: 8 MB Flash; 16 MB DRAM  
Print width: 4.09 in (104 mm) maximum  
Print speed: 3 in (76 mm) sec

### Media Characteristics:

Maximum label and liner width  
RW 420: 4.12 in/105 mm  
RW 220: 2.37 in/60 mm

### Minimum Label And Liner Width:

RW 420: 2 in (51 mm)  
RW 220: 1 in (25 mm)

### Maximum Roll Diameter:

2.25 in (57 mm)

### Core Diameter:

75 in (19 mm) or 1.38 in (34.9 mm)

### Media Type:

Receipt, tag, gap, continuous receipt

### Operating Characteristics:

Temperature: -4° F to 131° F (-20° C to 55° C)  
Storage temperature: -22° F to 149° F (-30° C to 65° C)  
Operating/storage humidity:  
10-90% non-condensing

### Electrical:

External charger options  
Shock mounted internal components  
Cable connection RS-232 RJ-45 10 pin  
Selectable baud rate 9600 to 115.2 kbps  
Xon / Xoff hardware flow control  
USB full speed support

### Agency Approval:

CSA, CE Compliance Class B,  
FCC part 15, Class B

### Battery:

Lithium-ion 4.0Ah, 7.4V

### Physical Considerations:

Width: 6.3W x 6.9 H 3.0 in D  
Weight: 2.0 lb  
Orientation: center

### Programming Languages:

(Default is line mode)  
CDCL, ZPL, EPL, CPCL, XML

### Bar Codes / Symbologies:

Linear, Code 39, Code 93, UCC/EAN-128,  
Code 128, UPC-E, UPC-A, EAN-8, EAN-13  
EAN-14, UPC and EAN 2 or 5 digit extensions  
Plessey, FIM, Postnet, Interleaved 2 of 5  
MSI, Codebar, PDF417, Data Matrix  
MaxiCode, RSS, QR Code



RW 220



RW 420 Vehicle Mount



RW 420



Ram Mount Kit

## APPROVALS



FCC  
NRTL

## Standard Features

- Print method: direct thermal
- Construction: impact-modified polycarbonate with fused oil-and-abrasion-resistant rubber overmold (six-foot drop protection)
- Smart battery management (monitors battery for longer life and performance)
- 4 button angled LCD (standard)
- Resistant scalable fonts
- Media sensors: bar, gap
- Advanced 32 bit architecture for high-speed processing
- Standard serial and USB interfaces
- Programming language: native CPCL, ZPL, EPL and XML support (standard)
- Auto-detect firmware load
- Print speed 3 ips

## Options

- Magnetic strip reader and EMV™ level one certified smart card reader
- Lithium ion fast AC charger
- Lithium ion quad charger
- Lithium ion DC charger with cigarette lighter adapter
- Fanfold bin
- Vehicle cradle for docking and charging
- Ram mount kit
- Shoulder strap/hand strap
- Environmental soft case
- Fanfold media support
- Wireless security support (ie. 802.11i, WPA, WPA2)

# Zebra® RW 420/RW 220

Thermal Portable Printer

## Part Number/Price

PART #	DESCRIPTION	WEIGHT	PRICE
105143	RW 220, USB serial, 2 in wide, lithium-ion battery	5 lb	\$700.00
105144	RW 420, USB serial, 4 in wide, lithium-ion battery	5 lb	975.00

## Options/Accessories

PART #	DESCRIPTION	PRICE
105146	RW 420 Vehicle cradle with built-in DC/DC 9 -30VDC charger and open ended cable	\$375.00
105145	Ram mount kit and base plate	225.00
105147	RW 220 Vehicle cradle with built-in Lithium-ion DC/DC 12VDC	170.00
105148	RW 220 Vehicle cradle with built-in Lithium-ion DC/DC 9 -30VDC	280.00
105149	RW 220 Vehicle cradle with built-in DC/DC 30 to 60VDC	400.00
105150	Lithium-ion fast charger (charging single battery outside printer)	115.00
111252	Lithium-ion battery, AK18026-002, RW 220	105.00
107163	Lithium-ion battery AK17463-005, RW 420	135.00
105151	Serial, RJ-45 interlocking PC cable	65.00
106442	RJ-45 blunt end cable to Rice Lake indicators	55.00
<b>Media</b>		
105566	One ply thermal 2 in receipt paper, RW 220 79 ft rolls, 2.5 in OD (36 per case)	66.25/case
105565	One ply thermal 4 in receipt paper, RW 420 79 ft rolls, 2.25 in OD (36 per case)	121.00/case
110463	2 in x 3 in label, RW 220 or RW 420, 125 labels/roll, 2 in OD, 36 per case	112.00/case

Labels available by special order

### Forklift Example

**Printer model** RW420 or 220  
**Ram mount kit** 105145  
**Power supply** 105146 (RW420)  
                   105147  
                   105148 — (RW220)  
                   105149  
**Serial cable** 105151 (for setup with PC)  
**Cable to indicator** 106442  
**Paper**

# WinWedge® TAL Software

Wedge Software

## Specifications

### System Requirements:

- Any version of Windows®
- Any Windows PC
- 4 MB of RAM
- 2 MB of hard disk space

### Communications:

WinWedge can collect data on any serial port (RS-232 or RS-485) and even on multiple ports simultaneously. Also supports full device control.

### Software Support:

Rice Lake Weighing Systems offers field software support for our software packages. Contact our Service Department for software support. Software support is a chargeable service.

## Standard Features

- Input scale or instrument data directly into Excel®, Access®, statistical software, LIMS, MMIs, any Windows® application
- Transfers RS-232 data quickly, accurately and formatted to your exact specifications
- Powerful DDE options for collecting data from multiple devices simultaneously
- Extremely easy to set-up and use
- 32 Pro, TCP/Wedge additional features:
- Support for even the most complex devices and serial I/O with advanced data parsing, filtering, formatting and translation
- Support for TCP/IP as well as RS-232 data collection and I/O
- More advanced device control options
- Additional features such as math functions and virtual instrument mode
- Five RS-232 and TCP/IP communications software products provided free of charge

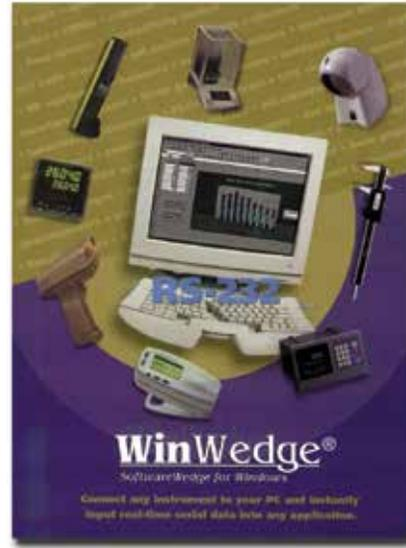

## Part Number/Price

PART #	DESCRIPTION	PRICE
75351	WinWedge® TAL software, 32 Std	\$325.00
72304	WinWedge® TAL software, 32 Pro, TCP/Wedge	545.00

1. Select how you want the data collected:

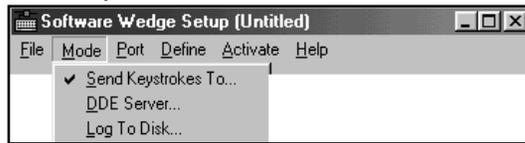

2. Choose the communication parameters for your serial device:

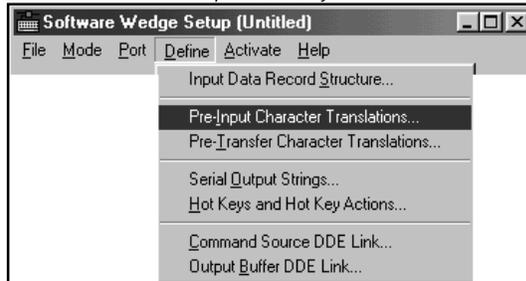

3. Define how you want the serial data to be parsed, filtered, and translated:

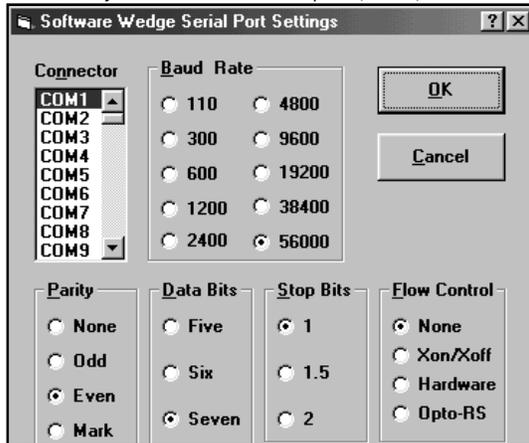

4. Activate WinWedge and watch your serial data "pop" into your application:

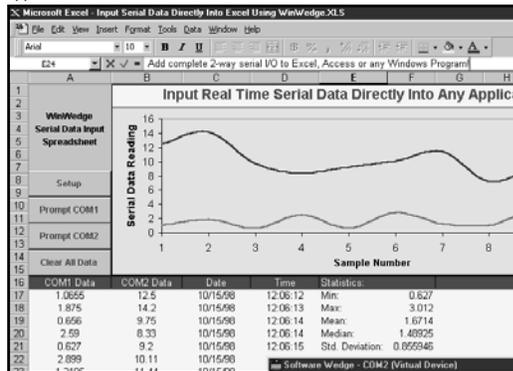

# DTL

Direct Thermal Label

## Applications

- Recommended for paper, corrugated containers, folding cartons with exterior varnish, glass, metal, PVC, polyesters, acetate, cellophane XT polymer, polystyrene and some treated polypropylenes and polyethylenes

## Standard Features

- Requires a 633nm Visible Light Diode (VLD) scanning device for bar codes
- All-temperature permanent acrylic adhesive with short repositioning time, withstands some contact with alcohol, blood, grease and water



Not recommended for applications with exposure to sunlight, fluorescent lamps or heat.

## Part Number/Price

PART #	WIDTH X LENGTH	ROLL DIA.	CASE QTY	LABELS PER ROLL	PERF.	PRICE
<b>0.75 in Core Size</b>						
110463	2.00 in x 3.00 in	2 in	36	125	Yes	\$112.00/case
<b>1 in Core Size</b>						
110346	1.20 in x 0.85 in	5 in	6	2710	Yes	8.25/roll
35342	2.0 in x 1.0 in	4 in	12	1375	Yes	8.50/roll
110350	2.00 in x 1.00 in	5 in	16	2600	Yes	15.05/roll
37354	2.25 in x 1.25 in	2 in	12	260	Yes	5.15/roll
40332	2.25 in x 2.00 in	5 in	12	1445	Yes	14.25/roll
110348	2.25 in x 3.00 in	5 in	16	950	Yes	13.50/roll
37352	2.25 in x 4.00 in	4 in	12	380	Yes	8.50/roll
110349	2.25 in x 4.00 in	5 in	12	700	Yes	10.80/roll
65617	2.25 in x 4.50 in	5 in	16	600	Yes	14.60/roll
110347	2.25 in x 1.25 in	5 in	16	2100	Yes	12.80/roll
156746	3.00 in x 2.00 in	4 in	8	800	Yes	9.95/roll
110352	3.00 in x 3.00 in	5 in	8	950	Yes	18.75/roll
110351	3.50 in x 1.00 in	5 in	8	2600	Yes	22.00/roll
110353	4.00 in x 1.00 in	5 in	8	2500	Yes	21.60/roll
37350	4.00 in x 1.50 in	4 in	12	960	Yes	27.45/roll
110354	4.00 in x 1.50 in	5 in	8	1800	Yes	21.00/roll
110345	4.00 in x 2.00 in	5 in	8	1400	Yes	19.20/roll
110355	4.00 in x 2.50 in	5 in	8	1100	Yes	20.10/roll
53251	4.00 in x 3.00 in	5 in	12	930	Yes	23.35/roll
41978	4.00 in x 3.00 in	4 in	8	500	Yes	11.50/roll
37348	4.00 in x 3.00 in	2 in	12	110	Yes	5.95/roll
40331	4.00 in x 4.00 in	5 in	8	745	Yes	23.35/roll
110356	4.00 in x 5.00 in	5 in	8	500	Yes	19.00/roll
37345	4.00 in x 6.00 in	5 in	8	450	Yes	20.00/roll
<b>3 in Core Size</b>						
21776	3.00 in x 3.00 in	8 in	8	2000	Yes	40.25/roll
156745	3.00 in x 5.00 in	8 in	8	1200	Yes	28.00/roll
91303	4.00 in x 2.00 in	8 in	4	2900	Yes	37.60/roll
43937	4.00 in x 4.00 in	8 in	4	1500	Yes	37.85/roll
25935	4.00 in x 6.00 in	8 in	4	1000	*	34.10/roll
150921	4.00 in x 6.00 in	8 in	4	1000	Yes	30.50/roll
20594	4.00 in x 6.50 in	8 in	4	900	Yes	32.70/roll
25975	4.25 in x 2.50 in	6 in	6	1090	Yes	25.65/roll
20531	4.50 in x 2.50 in	8 in	4	2500	*	50.75/roll
20597	3.5 in x 3.25 in	10 in	10	3100	No	70.00/roll
<b>Star Labels (1 in Core Size)</b>						
70598	Black line, 3 in x 1 in	4 in	10	1600	No	22.00/roll
70597	Black line, 3 in x 2 in	4 in	10	900	No	22.00/roll
<b>Medical</b>						
107134	1 in x 11 in Datamax O-Neil SafeD-Band, wristband	5 in	4	350		398.00/case

\* Perforated liner available upon request at no charge. Minimum order quantities may apply. NOTE: 8 in and 10 in diameter rolls are not Allegro compatible

Custom label quote form online at [www.ricelake.com/customlabel](http://www.ricelake.com/customlabel)

## DTL Plus/DTT/DTL-SYN

### Standard Features

- Top-coated white matte finish
- Requires a visible light (633nm) scanning device for bar codes
- Withstands some contact with alcohol, blood, grease and water
- Consult for pricing

### Part Number/Price

PART #	DESCRIPTION	PRICE
109340	3 in wide continuous tag stock, 7.2 mil, 3 in core, 8 in O.D., 480 ft wound out	\$37.50
109298	4 in wide continuous tag stock, 7.2 mil, 3 in core, 8 in O.D., 480 ft wound out	40.00
119829	3.5 x 5.5 in perforated, tow up fan folded stacks of 1000, min. order of 1000	0.05 each

DTL-Plus  
High-speed Thermal Transfer Label



*Not recommended for applications with exposure to sunlight, fluorescent lamps or heat*

DTT  
Direct Thermal Tag Stock



### Standard Features

- Top-coated white matte finish
- Requires a visible light (633nm) scanning device for bar codes
- All-temperature permanent acrylic adhesive with short repositioning time
- Withstands some contact with alcohol, blood, grease and water

### Part Number/Price

PART #	DESCRIPTION	PRICE
109448	3.25 x 3.25, 3 in core, 8 in O.D., 1800 LPR, wound out, 208 roll minimum order	\$90.00/roll

DTL-SYN  
Direct Thermal Synthetic Label



# TTL-RFID Labels/TTL

## Standard Features

- RFID Technologies including 900 MHz and 13.56 MHz
- Media faces from lower cost paper to durable films
- TAG form or adhesive backed
- Adhesives for different surfaces
- Thermal transfer
- Cosult for pricing

TTL RFID  
Thermal Transfer Label



TTL  
Thermal Transfer Label



## Standard Features

- All temperature permanent acrylic adhesive
- Withstands some contact with alcohol, oil, grease, blood and water

## Part Number/Price

PART #	WIDTH X LENGTH	ROLL DIA.	CASE QTY	LABELS PER ROLL	PERF.	PRICE
<b>1 in Core Size</b>						
110357	1.50 in x 1.00 in	5 in	8	2260	Yes	\$8.40/roll
110362	2.00 in x 1.00 in	5 in	8	2260	Yes	10.45/roll
110358	2.25 in x .750 in	5 in	6	3320	Yes	10.35/roll
110360	2.25 in x 3.00 in	5 in	6	930	Yes	11.05/roll
110359	2.25 in x 1.25 in	5 in	12	2100	Yes	10.35/roll
110365	4.00 in x 2.00 in	5 in	6	1370	Yes	18.00/roll
53261	4.00 in x 3.00 in	5 in	12	930	Yes	18.05/roll
110366	4.00 in x 4.00 in	5 in	12	700	Yes	18.00/roll
160934	4.00 in x 4.00 in	5 in	12	700	No	18.00/roll
110367	4.00 in x 6.00 in	5 in	12	475	Yes	16.50/roll
<b>3 in Core Size</b>						
21785	2.00 in x 1.00 in	8 in	12	5500	*	12.95/roll
25945	2.00 in x 1.00 in	6 in	12	2550	*	9.00/roll
66541	2.50 in x 1.75 in	8 in	2	3600		80.00/roll
44347	2.50 in x 1.50 in	8 in	8	3600	No	160.00/case
20671	3.00 in x 3.00 in	8 in	8	2000	*	23.00/roll
48408	3.50 in x 1.00 in	8 in	4	5500	Yes	86.55/case
156741	4.00 in x 4.00 in	8 in	4	1500	Yes	18.30/roll
21788	4.00 in x 6.00 in	8 in	4	1000	*	17.90/roll
20573	4.00 in x 6.50 in	8 in	4	900	*	19.20/roll
156742	4.00 in x 6.00 in	8 in	4	1000	Yes	17.90/roll
20536	4.50 in x 2.50 in	8 in	4	2500	*	34.55/roll
<b>Kit, 4 label rolls, 2 ribbons, 1 cleaning card</b>						
126629	4.00 in x 4.00 in	8 in	1	1500		100.95/case

\* Perforated liner available upon request at no charge. Minimum order quantities may apply.

NOTE: 8 in diameter rolls are not Allegro compatible. Custom label quote form available online

NOTE: Not recommended for long-term exposure to water or other liquids

# Fantastock Thermal Transfer Label

## Part Number/Price

PART #	WIDTH X LENGTH	ROLL QTY.	CASE	LABELS PER ROLL	PRICE
<b>1 in Core Size</b>					
35417	Fantastock 4 in x 2.88 in	4	8	500	\$37.50/roll
126114	3 in x 1 in TTL Fantastock	4	8	500	40.00/roll
129377	4 in x 2.5 in	5	8	1650	128.00/roll
21794	4 in x 2.875 in , 3 in core, 8 in O.D. minimum 4 rolls	4	4		155.00/roll

NOTE: 8 in diameter rolls are not Allegro compatible

## TTT Standard Tag

### Standard Features

- Withstands some contact with alcohol, oil, grease, blood and water
- Suited for alphanumerics, bar codes and graphics
- Top-coated white matte finish



## Part Number/Price

PART #	WIDTH X LENGTH	ROLL QTY.	CASE	LABELS PER ROLL/FT.	PERF.	PRICE
<b>3 in Core Size</b>						
89190	4 in wide continuous 7.5 pt	8 in	4	400 feet	No	\$38.50/roll
107621	3.25 wide x continuous 7.5 pt, 11 in O.D., 50 roll minimum order	—	—	1010 feet	No	28.40/roll
124757	4.5 x 2.5 in, with sensing notch 20 roll minimum order	—	4	2300	Yes	51.50/roll
164870	4 x 6 in, stack of 1000	—		1000		28.50/stack

NOTE: Not recommended for long-term exposure to water or other liquids

## SDR Super Durable Ribbon

### Standard Features

- 4.6 micron thermal transfer resin-based ribbon
- Smudge and smear proof
- 1182 ft (360.3 m) long (one ribbon prints two rolls of 8 in (203.2 mm) O.D. label or tag stock)
- Avoid exposure to heat, humidity and sunlight during storage



## Part Number/Price

PART #	WIDTH X LENGTH	COLOR	CASE QTY	DATAMAX COMP	ZEBRA/ELTON DESKTOP COMP	ZEBRA IND. COMP.	PRICE
<b>1/2 in Core Size</b> Not for all 2" wide printers							
37366	2.50 in x 242 ft	No	12	No	800009-002	No	\$5.70/roll
126115	3.27 in x 243 ft	No	36	221967	No	No	7.95/roll
37368	4.30 in x 242 ft	No	12	No	800009-004	No	9.35/roll
92633	4.33 in x 360 ft	No	24	226757	No	No	15.00/roll
<b>1 in Core Size</b>							
21772	4.00 in x 1182 ft	Yes	24	221716	No	No	1,015.00/case
52343	4.30 in x 1476 ft	No	6	No	5095BK11045	Yes	84.00/roll
129378	4.30 in x 984 ft	—	24	296639	—	—	35.15/roll

Scannable colors include: Blue, Red, White, Gold



# MaxWax™ GPR

General-Purpose Ribbon

## Standard Features

- 4.6 micron thermal transfer wax/resin ribbon
- Smudge and scratch resistant
- 1182 ft (360.3 m) long (one ribbon prints two rolls of 8 in (203.2 mm) O.D. label or tag stock)
- Avoid exposure to heat, humidity and sunlight during storage



## Part Number/Price

PART #	WIDTH X LENGTH	COLOR	DATAMAX COMP.	ZEBRA/ELTRON COMP.	ZEBRA INDUSTRIAL COMP.	CASE QTY	PRICE
<b>1/2 in Core Size</b> Not for all 2 inch wide printers							
81212*	2.50 in x 244 ft	No	Z28GPRM064074	8000130-002	No	12	\$6.65/roll
37362	2.50 in x 298 ft	No	226351	800008-002	No	36	5.70/roll
35477	3.50 in x 360 ft	No	226455	No	Yes	12	8.25/roll
37364	4.30 in x 298 ft	No	226357	800008-004	No	36	10.40/roll
75895*	4.30 in x 244 ft	No	Z28GPRM110074	800130-104	No	12	9.75/roll
35478	4.33 in x 360 ft	No	226457	No	Yes	12	10.65/roll
53265	1.30 in x 298 ft	No	No	800008-001	No	36	2.60/roll
<b>1 in Core Size</b>							
110537	2.50 in x 984 ft	No		ZEBGPRM064300		24	4.50/roll
34054	3.00 in x 1181 ft	Yes	226102	No	No	6	17.25/roll
40787	4.30 in x 1189 ft	No	No	800010-004	Yes	6	28.00/roll
110536	4.30 in x 984 ft	No	296143	NO	No	24	13.50/roll
34058	4.50 in x 1182 ft	Yes	226100	No	No	6	27.50/roll
42474	6.00 in x 1476 ft	Yes	224108	No	No	24	42.90/roll
<b>GPR Plus (for use with Kimdura Stock)</b>							
53611**	1.57 in x 1476 ft	No	No	No	5095BK04045	6	28.10/roll
20538	2.0 in x 1182 ft	No	222103	No	No	36	8.40/roll
20539	3.00 in x 1182 ft	No	222102	No	No	6	105.25/case
34056	4.00 in x 1182 ft	No	222116	No	No	24	25.25/roll

Prices for black ribbon only.

Color ribbon—contact RLWS Sales for prices and availability.

Scannable colors include: Silver, Gold, Green, Blue, Brown, Purple, Maroon, Midnight Blue, Fuchsia, Kelly Green, Royal Blue, Lavender

Additional colors available: Red, Orange, Yellow, White, Pink, Pumpkin

\* Ribbon for TLP2844

\*\*Resin Performance

# Tape and Ticket Printer Impact Ribbons

## Standard Features

### TicketPress:

- Cartridge-type
- Ribbon life is approximately 3 million characters

### SP2200 and SP2000:

- Cartridge-type
- Ribbon life is approximately 1 million standard characters

### IDS-150A, IDS-152, and IDS-160:

- Inked spools

### TM-U295, TM-U200, TM-300:

- Cassette-type
- TM-U295: Ribbon life is approx. 1.5 million standard characters
- TM-U200 and TM-300: Ribbon life is approx. 4 million characters (continuous printing)

### Citizen® CBM-750 and Citizen® iDP-3111:

- Cassette-type
- CBM-750: Ribbon life is approx. 4 million lines (continuous printing) iDP-3111: Ribbon life is approx. 1 million lines (continuous printing)

### Okidata 184 Turbo and 320:

- Self-inking
- Ribbon life is approximately 3 million characters

### DH4000 and Toledo 8806A, SP298, SP2320 and SP2520, LC-7211, SP349 and SP300, DP8340:

- Cassette-type



## Part Number/Price

PART #	DESCRIPTION	PRICE
<b>SP2200 and SP2000 Ticket Printer</b>		
20308	Black ink cartridge	\$24.00
<b>TicketPress™ Ticket Printer</b>		
128031	Black ribbon cartridge	20.00
132405	Purple ribbon cartridge	20.00
<b>IDS-150A and IDS-152 Ticket Printer</b>		
20440	Purple ink ribbon	10.00
<b>IDS-160 Tape Printer</b>		
20447	Purple ink ribbon	10.00
<b>Epson® TM-U295 Ticket Printer</b>		
29584	Purple ink cartridge (ERC 27)	12.00
29583	Black ink cartridge	12.00
<b>Epson TM-U200/TM-U220 and TM-300 Tape Printer</b>		
31296	Purple ink cartridge (ERC 30, 34)	12.00
<b>Epson TM-U590 Ticket Printer</b>		
68525	Purple ink cartridge (ERC-31)	12.00
<b>Citizen CBM-750 Tape Printer</b>		
41902	Red/black ribbon cartridge	7.00
<b>Okidata 184 Turbo and 320 Line Printer</b>		
20664	Ribbon cartridge	8.00
<b>DH4000 and Toledo 8806A and Fairbanks 50-3925 Tape Printer</b>		
20428	Purple ribbon cartridge (no blue guide)	20.00
<b>Star® SP298, SP2320 and SP2520 Ticket Printer</b>		
69921	Purple ribbon cartridge	12.00
<b>Star SP349 and SP312 Tape Kiosk Printer</b>		
69920	Purple ribbon cartridge	13.00
<b>Star DP8340 Tape Printer</b>		
20447	Purple ribbon cartridge	10.00
<b>Star SP700 Tape Printer</b>		
103728	Black ribbon cartridge	12.00
<b>EXTECH 2000i Tape Printer</b>		
87387	Purple ribbon cartridge	8.00

Don't see a ribbon or paper roll you need? Send us the manufacturer name and model of the printer and we will quickly fax you a quotation.

# Tape Printer Paper Supplies

## Standard Features

### IDS-150A, IDS-152, IDS-160, TM-U200, TM-300, and Citizen® CBM-750:

- One-ply paper roll: 3 in W x 150 ft L (76.2 mm W x 45.7 m L)
- Two-ply paper roll: 3 in W x 90 ft L (76.2 mm W x 27.4 m L)

### Citizen® iDP-3111:

- One-ply paper roll: 2.25 in W (57.1 mm W)

### Star®:

- One- and two-ply paper roll: 3 in W x 3 ft L (76.2 mm x 0.9 m)
- One-ply thermal paper roll: 3.125 in W x 3.25 ft L (76.2 mm x 0.99 m), 8 in roll dia.



## Part Number/Price

PART #	DESCRIPTION	PRICE
<b>IDS-150A, IDS-152, IDS-160, TM-U220, TM-300, and Citizen CBM-750:</b>		
69916	One-ply Bond, 3 in W (76.2 mm) x 150 ft L (45.7 m), 3 in dia., 1/2 in core	\$5.00/roll
69915	Two-ply Bond, 3 in W (76.2 mm x 90 ft L x 27.4 m), 3 in dia, 1/2 in core white/canary yellow	7.00/roll
<b>Citizen iDP-3111:</b>		
42870	One-ply Bond, 2.25 in W (57.1 mm) x 150 ft L, 7/16 in core 2 7/8 in outer diameter	5.00/roll
<b>Star:</b>		
69916	One-ply Bond, 3 in W (76.2 mm) x 150 ft L (45.7 m), 3 in dia., 1/2 in core	5.00/roll
69915	Two-ply Bond, 3 in W (76.2 mm x 90 ft L x 27.4 m), 3 in dia, 1/2 in core white/canary yellow	7.00/roll
69917	One-ply thermal, 3.125 in W (76.2 mm) x 3.25 in dia. 7/16 core 295 ft	5.00/roll
70083	One-ply thermal, 3.23 in W (82 mm) x 3 in dia., 8 in roll dia. (2020 ft long) 1 1/2 core	35.00/roll
71214	One-ply plain paper, 3.25 in W (82.5 mm) x 3 in dia., 50 rolls/case, 3/8 core	95.00/case
105711	Two-ply plain paper, 3.25 in W, 50/case, 3/8 core 3 in outer diameter	150.00/case
105712	Three-ply plain paper, 3 in wide, 50 per case, 3/8 core, 3 in outer diameter (white, canary, pink)	160.00/case
102950	One-ply thermal, 4.4 in wide, 6 in outer diameter, 1 in core, 930 ft roll	42.50/roll
20448	One-ply Bond, 4.5 in wide x 165 ft, 7/16 core, 3 in outer diameter	8.00/roll
42672	Two-ply, 4.5 in wide x 95 ft, 3 in outer diameter	7.00/roll
70683	One-ply Bond, 4.5 in wide x 3 in diameter, sprocket feed, 140 ft	11.00/roll
107618	One-ply thermal, 110 mm (4.4 in) x 4 in outer diameter, 500 ft	10.50/roll
102957	One-ply thermal, 58 mm (2.28 in) x 2 3/4 outer diameter, 1/2 in core	3.50/roll
<b>Epson:</b>		
105445	One-ply thermal, 80 mm (3.1 in) wide, 6 in outer diameter, 710 ft/roll	25.00/roll
105446	One-ply thermal, 80 mm (3.1 in) wide, 8 in outer diameter, 1268 ft/roll	27.00/roll
75947	One-ply Thermal, 2.25 in wide x 85 ft, 1 7/8 outer diameter, Mobilink, 1/2 in core	6.00/roll
126092	1 ply receipt 2 in W x 574 ft, 1 in core, 5 in O.D., 6 rolls/case	72.50/case
<b>Kiosk Printers:</b>		
50426	One-ply, 3.25 in wide, 6 in diameter 7/16 core 950 ft	24.00/roll
104940	One-ply thermal, 112 mm wide, 5 in diameter, 1 in core, 625 ft	24.00/roll
<b>Zebra Mobile:</b>		
105566	One-ply thermal, 2 in continuous 79 ft rolls, 2.5 in OD (36 per case)	66.25/case
105565	One-ply thermal, 4 in continuous 79 ft rolls, 2.5 in OD (36 per case)	121.00/case
<b>Misc:</b>		
66653	One-ply thermal, 80 mm (3.1 in) wide, 455 ft long 5 in diameter for Swecoin, Star TUP 900	18.00/roll
76076	One-ply thermal, 60 mm(2 3/8 in) x 100 mm outer diameter 40 mm core, wound out	13.00/roll
73134	One-ply Bond, 1 3/4 in wide x 1-7/8 outer diameter, 7/16 core	3.50/roll
47341	One-ply thermal, 64 mm x 50 meter, 1 9/16 in core	5.00/roll
110463	2 in x 3 in label, RW 220 or RW 420, 125 labels/roll, 2 in OD, 36 per case	112.00/case

# Electronic Scale Tickets

Hecon Printers, EL522 and EL516 - 20266

## Standard Features

- Carbon triplicate interleaved
- Size: 7.875 W x 4.25 in L (200 x 127 mm)
- Order quantity: 500 per package

20266

Form 510 is a standard electronic scale ticket. It includes fields for DATE, No., SELLER, BUYER, ADDRESS, CITY, STATE, and ZIP. It also has sections for GROSS, TARE, and NET weights, and a DRIVER ON/OFF checkbox. The bottom right corner is labeled FORM 510.

TicketPress, SP2200, SP2000 - 20265

## Standard Features

- Carbon triplicate interleaved, perforated and glued on one end
- Size: 9 in W x 5.5 L (228.6 x 139.7 mm)
- Order quantity: 500 per package

20265

Form ES-4 is an electronic scale ticket with a perforated edge on the right side. It includes fields for DATE, No., SELLER, BUYER, ADDRESS, CITY, STATE, and ZIP. It also has sections for COMMODITY, PRICE, REMARKS, and a DRIVER ON/OFF checkbox. The bottom right corner is labeled Form ES-4.

TicketPress, Rice Lake Scales - 71630 or 105182

## Standard Features

- Carbonless duplicate or triplicate
- Size: 4.25 x 7 in (107 x 177.8 mm) attached at 4.25 top edge
- Order quantity: 500 per package
- Custom (Duplicate):
- Add company name (min. order 5 packs, \$70.00 ea)
- Custom (Triplicate):
- Add company name (min. order 5 packs, \$85.00 ea)

Form 71630/105182 is a carbonless scale ticket. It includes a Customer Name field and a Customer Signature line. The Rice Lake logo is visible at the bottom.

TicketPress, Blank Scale Ticket - 22263

## Standard Features

- 3-part carbonless
- White, canary yellow, and pink
- Size: 4.25 W x 5.5 in L (108 x 140 mm)
- Attached at 4.25 edge
- Custom: Add company name (min. order of 2500: \$0.22 ea)

Form 22263 is a blank scale ticket, shown as a large empty rectangular box.

## Part Number/Price

PART #	DESCRIPTION	PRICE
20266	Hecon Printers, EL522 and EL516, 500/pack	\$92.00
20265	SP2200, SP2000, TicketPress, 500/pack	95.00
71630	Rice Lake ticket, 2 part, 500/pack	50.00
105182	Rice Lake ticket, 3 part, 500/pack white, canary yellow, pink	72.00
22263	Blank scale ticket, each	0.22 each

# Mechanical Scale Tickets

Fairbanks™ Scales - 20260

## Standard Features

- Carbon triplicate with 2 in (50.8mm) tear-off flap
- Size: 4.75 W x 1.875 in L (120.7 x 47.6 mm)
- Order quantity: 500 per package

WEIGHED ON A FAIRBANKS SCALE			No. _____
Load _____	Date _____		Received by _____
From _____			
Gross _____ lbs.	To _____		
Tare _____ lbs.	Address _____		
Net _____ lbs.	Price _____	Amt. _____	
On _____	Off _____	Weigher _____	
Form 333A		Printed in U.S.A.	

Create Your Own Custom Ticket

## Standard Features

- Send us a copy of the existing custom format or drawing of a completely new one. Please specify number of carbon copies, dimensions, colors and text. Minimum order quantity may apply. Download form at [ricelake.com/customlabel](http://ricelake.com/customlabel)



## Part Number/Price

PART #	DESCRIPTION	PRICE
20260	Fairbanks Scales, 500/pack	\$65.00
20261	Howe Scales, 500/pack	65.00

Howe™ Scales - 20261

## Standard Features

- Carbon triplicate with 2 in (50.8 mm) tear-off flap
- Size: 5.5 W x 1.75 in L (139.7 x 44.5 mm)
- Order quantity: 500 per package

Weight obtained by using THE HOWE PATENTED RECORDING BEAM			No. _____
From _____	To _____		Form 3A
Gross _____	Load of _____		
Tare _____	Driver { On _____		
Fees _____	Off _____	Date _____ 20 _____	
Net _____	Weigher _____		

# Replacement Print Heads

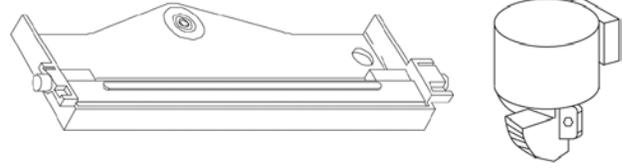

## Part Number/Price

PART #	DESCRIPTION	PRICE
<b>Ticket Printers</b>		
Epson		
29535	TM-290/TM-U295	\$300.00
116659	TM-U590	300.00
Rice Lake Weighing Systems		
35347	SP2200	300.00
33969	SP2000A, serial number >6000 (limited stock available)	300.00
20301	SP2000, serial number <6000 (has ribbon cable) (limited stock available)	350.00
<b>Tape Printers</b>		
Epson		
32789	TM-300D	168.00
68726	TM-U590 print mechanism	845.00
Star		
72513	SP298	125.00
<b>Label Printers</b>		
Datamax-O'Neil		
20846	Allegro, Allegro 2, DMX400, Prodigy Plus, Prodigy Max (203 DPI) limited stock available	550.00
20665	Prodigy, limited stock available	495.00
43095	DMX600	1,095.00
51126	DMX800, new style TDK for printers with CID # of E53-XX-XXXXXXXX or greater, W-8306	1,095.00
53939	I-4208 I-4210, I-4212 (203 DPI)	450.00
66748	I-4308 (300 DPI)	550.00
67552	W-6208 (203 DPI) prior to Dec, 1999, 6 in	695.00
82859	W-6208 (203 DPI), DPO 20-2164-01, 1999 to to current, 6 in	695.00
67551	W-6308 (300 DPI), 6 in	995.00
103369	M-4210, 203 DPI	495.00
96957	H-4212, 203 DPI	450.00
96958	H-4310, 308 DPI	695.00
72473	Ex2, E-4203 (203 DPI)	200.00
112517	E4205 (e) 203 (DPI)	125.00
103368	M4206, (203 DPI)	495.00
118183	Print engine A-class model 4212, 203 dpi	450.00
Eltron/Zebra®		
53034	LP/TLP2622/2722, 2 in	325.00
78998	LP/TLP-2824 (2 in)	165.00
78999	LP-2844 (4 in)	195.00
79000	TLP-2844 (4 in)	210.00
38602	LP3642/TLP3642 (300 DPI)	620.00
51019	Orion LP-2443	225.00
95375	Z4000, S4M (203 DPI)	695.00
111091	Zebra GK,(203 DPI)	200.00

# Printer Cables



## Part Number/Price

PART #	DESCRIPTION	PRICE
<b>Interface Cables for TicketPress, SP-2200, TM-U295, TM-U590 and Star® Printers</b>		
15547	Blunt end, 25-Pin D-sub male RS-232 serial interface cable	\$65.00
15548	25-Pin D-sub male to 25-Pin D-sub male 20 mA serial interface cable (SP2200 only)	65.00
15568	25-Pin D-sub male to 25-Pin D-sub male RS-232 serial interface cable	65.00
Consult	Custom 20 mA/RS-232 serial interface cable	95.00
<b>Interface Cables for I-Class</b>		
15547	Blunt end, 25-Pin D-sub male RS-232 serial interface cable	65.00
Consult	Custom RS-232 interface cable	95.00
<b>Interface Cables for Desktops, GoDEX Models, Zebra, E-4203 and M-4206</b>		
41276	DB9 male RS-232 cable to blunt end	65.00
<b>Straight Cable</b>		
70056	DB9 male to DB9 female	35.00
50749	DB9 female to DB9 female	55.00
41279	DB25 male to DB9 male	65.00
<b>Null Modem Cable</b>		
66535	DB9F to DB9 female, Null modem	45.00
64794	DB9 male to DB9 female	45.00
<b>USB Cable</b>		
79074	USB-A to USB-B	30.00
153603	USB to 9-Pin Male RS-232 adapter	85.00
<b>Ethernet Cable/RJ45</b>		
72697	RJ45 to RJ45, 7 ft	35.00
78860	RJ45 to RJ45, cross over 7 ft	35.00
75594	RJ45 to 9-Pin female	65.00
<b>Misc. Cables and Adapters</b>		
22436	Blunt end, 9-Pin D-sub female	55.00
119064	Slimline, Null modem gender changer, DB9 female/female	10.50
130789	Null modem DB9 M/F	12.00

*Blunt-end cables interface to: UMC444, UMC555, UMC600, IQ700, IQ plus® 310A, IQ plus® 355, IQ plus® 390-DC, IQ plus® 510, IQ plus® 590-DC, IQ plus® 710, IQ plus® 800, and IQ plus® 810, 520 and 920®*

*Custom cables are designed to interface with your specific equipment. Please specify equipment model number and connector type. Standard cable length is 5' (1.5 m).*

## Scale Veils

Protect your electronic scales, weight indicators and printers with a scale veil. Reduce costly repairs and down time due to moisture penetrating through instrument enclosures during cleanup or operation.

### Standard Features

- Tough, flexible transparent vinyl, constructed with heavy-duty stitching
- Loose fit allows for operation of switches or controls through the scale veil
- Available for most types of scale equipment



### Part Number/Price

MODEL	PART #	PRICE
<b>RICE LAKE</b>		
IQ700, UMC600	21213	\$60.00
SP2000/SP2200	21210	75.00
<b>EPSON</b>		
TM290/295	29582	55.00
TM-U200 TM-U220	35666	60.00
TM-U590	111840	65.00
<b>OKIDATA</b>		
Okidata 184 Turbo Printer	21208	65.00
Okidata 320/390	21226	65.00

*Custom veils and specials available; consult factory.*



# Remote Displays/Scoreboards

## Table of Contents

<b>SURVIVOR® LaserLight® Series</b> .....	<b>780</b>
4in, 4in Stop/Go, 6in Remote Display	
<b>SURVIVOR® LaserLight® M-Series</b> .....	<b>782</b>
Messaging Remote Displays	
<b>LaserLT RD-1550</b> .....	<b>784</b>
1.5in LED Remote Display	
<b>RD-232</b> .....	<b>786</b>
0.8in LED Remote Display	
<b>RD-300</b> .....	<b>788</b>
1.0in LCD Remote Display	

**ESPAÑOL** | Visit [ricelake.com/spanish](http://ricelake.com/spanish)  
to see all RLWS materials  
available in Spanish

Product names, logos, brands, and other trademarks featured  
or referred to within this publication are the property of their respective trademark holders.

# SURVIVOR® LaserLight® Series

4 in, 4 in Stop/Go, 6 in Remote Display

## Standard Features

- Six high-intensity red digits (double-row discrete LED)
- Four high-intensity red annunciators for gross, net, lb, kg
- Available in 4 in (101 mm) and 6 in (152 mm) digit sizes
- Auto Learn mode of communication protocols
- Hold displayed weight (demand input)
- Software selectable stand still mode, no updates while in motion
- Software configuration menu
- Durable weather-tight enclosure
- Adjustable daylight/night intensity
- Non-glare contrast filtered lens
- Mirror (reverse image) feature
- RS-232, 20 mA, and RS-485 communications
- Auto sensing 115/230VAC power supply
- 6 in (152 mm) LaserLight enclosure mounting holes match SURVIVOR IQ, F40 Series remote display
- Porous polyethylene breather vent
- Red, green, arrow lights in stop/go version

## Specifications

### Display:

- 6 digit, 7 segment discrete oval precision optical performance red LED lamps
- Contrast enhanced optical filtering lens
- 1- or 2- place decimal or comma indication
- 4 annunciators for GR, NT, lb, kg
- Red, green 4 in light (manual switch or serial command)

### Maximum Viewing Distance:

- 4 in: 250 ft (75 m)
- 6 in: 300 ft (100 m)

### Input Interface:

- RS-232, RS-485, 20 mA current loop (active or passive, switch selectable)

### Output interface:

- Independently configurable echo out port, RS-232 or 20 mA current loop (active or passive, switch selectable)

### Input Data Format:

- Baud Rate: 1200, 2400, 4800, 9600, and 19,200 self learning or software selectable

### Character Format:

- 7 or 8 data bits; even, odd, or no parity; 1 or 2 stop bits, self learning or software selectable

### Update:

- Continuous or out-of-motion only; software selectable

### Power Consumption:

- 4 in (101 mm): 21 watt
- 6 in (152 mm): 27 watt

### Time:

- Software enable/disable, 12- or 24-hour format

### Date:

- Software enable/disable, US or ISO format

### Temperature:

- Software selectable °F or °C, temperature probe automatically detected

### Rating/Material:

- Weather proof, mild steel, powder coated

### Weight:

- 4 in (101 mm): 20 lb (9 kg)
- 6 in (152 mm): 25 lb (11 kg)

### Operating Temperature Range:

- 40°F to 120°F (-40°C to 48.8°C)

### Warranty:

- Two-year limited warranty

### Approvals:

- UL/CUL on specific part numbers



LaserLight 4 in Digit



LaserLight 4 in Digit with Stop and Go Lights



LaserLight 6 in Digit

## APPROVALS\*

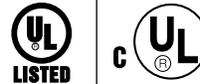

\*See specific part numbers

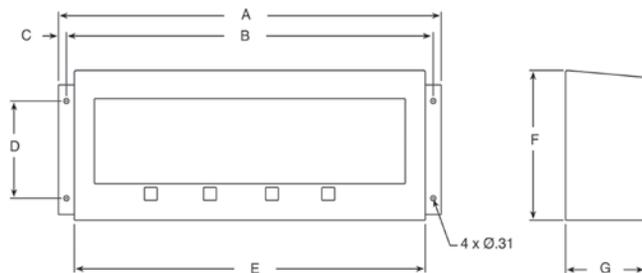

## DIMENSIONS

4 inch enclosure			
A	24.0 in (609 mm)	E	22.0 in (558 mm)
B	23.0 in (584 mm)	F	9.25 in (234 mm)
C	0.5 in (12 mm)	G	5.0 in (127 mm)
D	6.0 in (152 mm)		
4 inch stop/go enclosure and 6 inch enclosure			
A	32.0 in (812 mm)	E	30.0 in (762 mm)
B	31.0 in (787 mm)	F	12.25 in (311 mm)
C	0.5 in (12 mm)	G	5.0 in (127 mm)
D	7.75 in (196 mm)		

# SURVIVOR® LaserLight® Series

4in, 4in Stop/Go, 6in Remote Display

## Part Number/Price

PART #	DESCRIPTION	EST. SHIP WEIGHT	PRICE
75850	SURVIVOR LaserLight 4 in (100 mm)	22 lb	\$1,500.00
Consult*	SURVIVOR LaserLight 4 in (100 mm) marked UL/cUL	22 lb	1,700.00
87172	SURVIVOR LaserLight 4 in (100 mm) stainless steel	22 lb	2,000.00
Consult*	SURVIVOR LaserLight 4 in (100 mm) stainless steel, marked UL/cUL	22 lb	2,200.00
103181	SURVIVOR LaserLight 4 in (100 mm) with Red/Green Stop/Go Light	22 lb	2,000.00
151035*	SURVIVOR LaserLight 4 in (100 mm) with Red/Green Stop/Go Light, marked UL/cUL	22 lb	2,200.00
75852	SURVIVOR LaserLight 6 in (150 mm)	27 lb	1,950.00
151033*	SURVIVOR LaserLight 6 in (150 mm) marked UL/cUL	27 lb	2,150.00

\*LaserLights having UL approval

## Options/Accessories

PART #	DESCRIPTION	PRICE
43412	Temperature probe assembly	\$125.00
93250	Wireless RFI Interface, includes pair of ConnexLink Radio	795.00
75854	4 in LaserLight visor (not required for weather protection), field installable	120.00
75855	6 in LaserLight visor (not required for weather protection), field installable	120.00
75856	4 in LaserLight pole mount kit for 4 in to 8 in pole	150.00
77775	6 in LaserLight pole mount kit for 4 in to 8 in pole	195.00
75936	Additional operating manual	25.00

# SURVIVOR® LaserLight® M-Series

Messaging Remote Displays

## Standard Features

- Available with 8-character and 12-character display
- 2.75 in high-intensity red character (discrete LED)
- Four annunciators for gross, net, lb, kg
- Auto Learn mode of communication protocols
- Display messages scroll, slide and flash
- Hold displayed weight (demand input)
- Software selectable stand still mode, no updates while in motion
- Software configuration menu
- Durable weather-tight enclosure
- Adjustable daylight/night intensity
- Non-glare contrast filtered lens
- Mirror function
- RS-232, 20 mA, and RS-485 communications
- Auto sensing 115/230VAC power supply
- Porous polyethylene breather vent



SURVIVOR LaserLight M-Series 8-character Display  
12-character Display Also Available

## Specifications

### Display:

- 2.75 in digit; 5 x 7 dot matrix using discrete oval precision optical performance red LED lamps
- Contrast enhanced optical filtering lens
- 1- or 2-place decimal or comma indication
- 4 annunciators for GR, NT, lb, kg

### Input Interface:

- RS-232, RS-485, 20 mA current loop (active or passive, switch selectable)

### Maximum Viewing Distance:

- 150 ft (50 m)

### Output Interface:

- Independently configurable echo out port, RS-232 or 20 mA current loop (active or passive, switch selectable)

### Input Data Format:

- Baud Rate: 1200, 2400, 4800, 9600, and 19,200 self learning or software selectable
- Character Format: 7 or 8 data bits; even, odd, or no parity; 1 or 2 stop bits, self learning or software selectable

### Update:

- Continuous or out-of-motion only; software selectable

### Power Consumption:

- 8-character: 21 watt
- 12-character: 27 watt

### Time Option:

- Software enable/disable, 12- or 24-hour format

### Date Option:

- Software enable/disable, US or ISO format

### Temperature Option:

- Software selectable °F or °C, temperature probe automatically detected

### Rating/Material:

- Weather proof, mild steel, powder coated

### Weight:

- 8-character: 16 lb (7 kg)
- 12-character: 22 lb (10 kg)

### Operating Temperature Range:

- -40°F to 120°F (-40°C to 48.8°C)

### Warranty:

- Two-year limited warranty

### Approvals:

- UL/cUL on specific part numbers

## APPROVALS\*

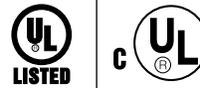

\*See Specific Part Numbers

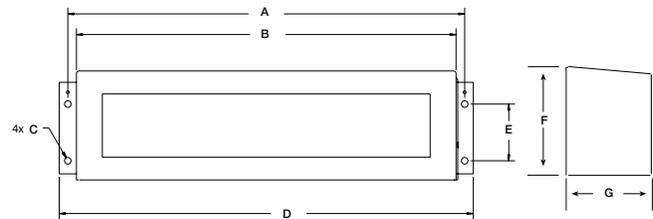

LaserLight 3M8

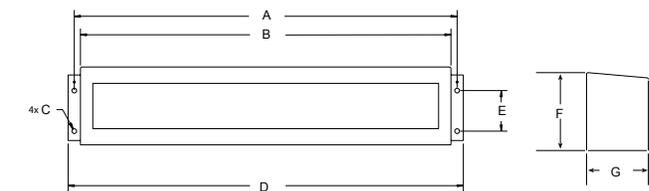

LaserLight 3M12

DIMENSIONS			
<b>3M8 Enclosure</b>			
A	23.00 in (584 mm)	E	3.25 in (83 mm)
B	22.00 in (559 mm)	F	6.25 in (159 mm)
C	4x 0.38 in (10 mm)	G	5.00 in (127 mm)
D	24.00 in (610 mm)		
<b>3M12 Enclosure</b>			
A	31.00 in (787 mm)	E	3.25 in (83 mm)
B	30.00 in (762 mm)	F	6.25 in (159 mm)
C	4x 0.38 in (10 mm)	G	5.00 in (127 mm)
D	32.00 in (813 mm)		

# SURVIVOR® LaserLight® M-Series

Messaging Remote Display

## Part Number/Price

PART #	DESCRIPTION	EST. SHIP WEIGHT	PRICE
85137	SURVIVOR LaserLight 3M8 8-character	22 lb	\$1,450.00
Consult*	SURVIVOR LaserLight 3M8 8-character, *marked UL/cUL	22 lb	1,650.00
85152	SURVIVOR LaserLight 3M12 12-character	27 lb	1,900.00
Consult*	SURVIVOR LaserLight 3M12 12-character, *marked UL/cUL	27 lb	2,100.00

\* LaserLights having UL approval

## Options/Accessories

PART #	DESCRIPTION	PRICE
75853	Time and date	\$125.00
43412	Temperature probe assembly	125.00
75854	3M8 visor (not required for weather protection), field installable	120.00
75855	3M12 visor (not required for weather protection), field installable	120.00
85343	3M8 LaserLight pole mount kit	195.00
85344	3M12 LaserLight pole mount kit	195.00
75936	Additional operating manual	25.00
103178	Wireless RFI Interface, includes pair of ConnexLink Radios (for 3M12 only)	795.00

# LaserLT RD-1550

1.5in LED Remote Display

## Standard Features

- Six red LED digits, 1.5in height
- Annunciators for weighing mode, units and status
- Red and green annunciator lights
- Programmable keys for remote scale functions (Zero, G/N, Tare, Units, Print)
- Auto Learn mode for easy connection
- Continuous or Demand mode inputs
- Stainless steel enclosure, hinged cover
- RS-232, 20 mA communication ports
- Option for fiber optic, USB, Ethernet TCP/IP, RS-422 or wireless communication
- Echo or addressable for displaying specific data
- Auto sensing power supply
- Software configuration menu
- Compatible with Revolution® Configuration Utility



## Specifications

### Display:

Six-digit LED, 7-segment character, 1.5 in height  
 Six annunciators for GR, NT, lb, kg, motion and COZ  
 One red/one green light (serial or I/O controlled)  
 Overlay with contrast filtered lens

*Optional visor for direct sunlight*

### Maximum Viewing Distance:

50 ft (15 m)

### Input Interface:

Port 1: 20 mA bidirectional  
 Port 2: RS-232 bidirectional  
 Port 3: RS-232 or pluggable option for Fiber Optic, USB, Ethernet TCP/IP, RS422  
 Port 4: RS-232 or pluggable option for wireless LAN

### Output Interface:

Echo (daisy chain) output mode – port selectable  
 Keypad output mode – configurable strings and port selectable

### Input Data Format:

Learn mode or software selectable for data types  
 Baud Rate: 1200, 2400, 4800, 9600, 19,200, 38,400, 57,600, 115,200  
 Characters: 7 even, odd or 8 none  
 Stop bits: 1 or 2 selectable

### Update:

Software selectable for continuous or demand formats to hold the displayed weight

### Digital I/O:

Two inputs for control of red and green lights

### Rating/Material:

NEMA 4X/IP69K, 304 stainless steel

### Weight:

10 lbs

### Operating Temperature:

-20°F to 120°F (-30°C to 50°C)

### Warranty:

Two-year limited warranty

### Approvals:

UL/cUL on specific part numbers

## APPROVALS\*

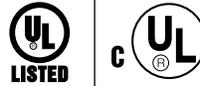

\*See Specific Part Numbers

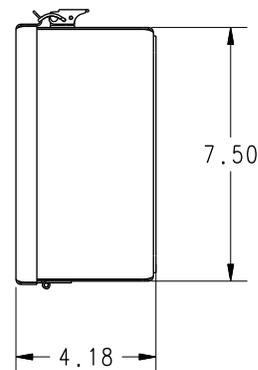
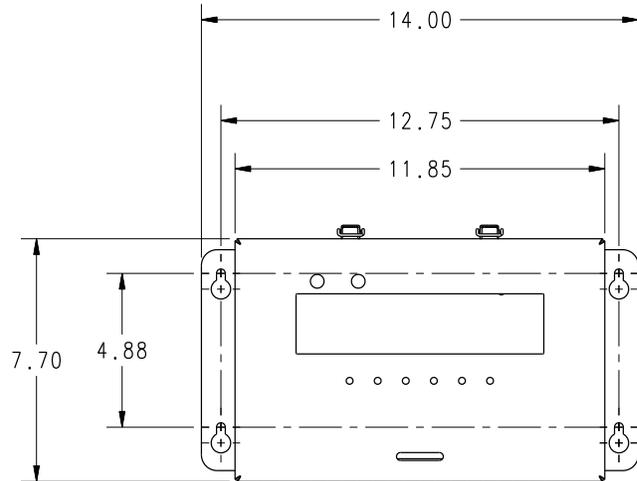

# LaserLT RD-1550

1.5in LED Remote Display

## Part Number/Price

PART #	DESCRIPTION	EST. SHIP WEIGHT	PRICE
111143	SURVIVOR LaserLT RD-1550 remote display, 90–260 VAC	10 lb	\$950.00
Consult*	SURVIVOR LaserLT RD-1550 remote display, 115 VAC, *marked UL/cUL	10 lb	1,150.00
111144	SURVIVOR LaserLT RD-1550 remote display, 9–36VDC	10 lb	1,050.00

\*Laser LT having UL approval

## Options/Accessories

PART #	DESCRIPTION	PRICE
77142	Ethernet TCP/IP board	\$400.00
96736	Fiber optic board	200.00
78026	Fiber optic cable, 100 ft	135.00
78027	Fiber optic cable, 200 ft	270.00
108579	RS-232/RS-422 board	260.00
108671	Wireless LAN board 802.11a/b	570.00
93245	USB board (requires USB cable, PN 95357)	160.00
115138	Visor	30.00
114035	Installation manual	25.00
77925	Revolution® configuration software	35.00

# RD-232

0.8in LED Remote Display

## Standard Features

- NEMA 4X Fiberglass-Reinforced Polyester (FRP) wall-mount enclosure
- Optional NEMA 4X stainless steel wall-mount enclosure or NEMA 12 panel-mount version
- Easy-to-read 6-digit 0.8 in (20.3 mm) LED
- AC or DC operation
- Four status annunciators
- Full floating decimal point
- RS-232 or 20 mA current loop active or passive interface
- Compatible with a variety of digital weighing indicators; DIP switch selectable intuitive data receiver interprets serial strings

## Specifications

**Display:**

6-digit, 7-segment, 0.8 in (20.32 mm) Light Emitting Diode (LED)

**Status Annunciators:**

lb, kg, gross, net

**Operating Voltage:**

115VAC, ±10% 60 Hz,  
DC Voltage Range: 6.2-18VDC  
230VAC available

**Input Interface:**

RS-232, 20 mA active or passive current loop, standard  
ASCII compatible

**Baud Rate:**

Selectable: 300, 600, 1200, 2400, 4800, 9600, 19,200

**Operating Temperature:**

-13°F to 104°F (-25°C to 40°C)

**Rating/Material:**

NEMA 4X FRP or optional stainless steel

**Weight:**

Approximately 5 lb (2.3 kg) Stainless steel unit, approximately 6 lb (2.7 kg)

**Warranty:**

One-year limited warranty

DIMENSIONS			
<b>FRP Enclosure</b>			
A	8.00 in (203 mm)	D	4.00 in (101 mm)
B	9.50 in (241 mm)	E	9.00 in (222 mm)
C	6.00 in (152 mm)		
<b>Stainless Steel Enclosure</b>			
A	6.00 in (152 mm)	D	4.00 in (101 mm)
B	9.50 in (241 mm)	E	8.75 in (222 mm)
C	3.87 in (98 mm)		
<b>Compact Enclosure</b>			
A	6.25 in (158 mm)	D	5.25 in (133 mm)
B	9.25 in (234 mm)	E	8.50 in (215 mm)
C	2.00 in (50 mm)		
<b>Panel Mount</b>			
A	5.88 in (149 mm)	D	5.12 in (130 mm)
B	7.88 in (200 mm)	E	7.12 in (180 mm)
C	2.00 in (50 mm)		



RD-232 NEMA 4X FRP Enclosure



RD-232 Compact Stainless Steel Wall Mount Enclosure



RD-232 NEMA 4X Stainless Steel Wall Mount Enclosure

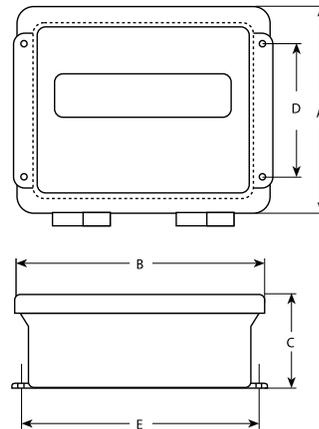



## RD-232

0.8in LED Remote Display

### Part Number/Price

PART #	DESCRIPTION	EST. SHIP WEIGHT	PRICE
32716	RD-232, 115VAC/12VDC, FRP enclosure	5 lb	\$950.00
68786	RD-232, 115VAC/12VDC, compact stainless steel wall mount enclosure	5 lb	950.00
32717	RD-232, 115VAC/12VDC, NEMA 4X stainless steel wall mount enclosure	8 lb	1,200.00
32727	RD-232, 115VAC/12VDC, panel mount	3 lb	850.00
34748	RD-232, 230VAC/12VDC, FRP enclosure	5 lb	1,000.00

*Specify interfacing indicator when ordering a remote display*

### Options/Accessories

PART #	DESCRIPTION	PRICE
32726	RD-232, 115VAC/12VDC board only	\$750.00
33210	Additional operating manual (RD-232/RD-300)	21.00

# RD-300

1.0in LCD Remote Display

## Standard Features

- NEMA 4X Fiberglass-Reinforced Polyester (FRP) wall mount enclosure
- Optional NEMA 4X stainless steel wall mount enclosure
- Easy-to-read 1 in (25.4 mm) Liquid Crystal Display (LCD)
- RS-232 and 20 mA active current loop interface
- Status annunciators
- AC operation
- Optional display with backlight for dark conditions
- Compatible with a variety of digital weighing indicators; intuitive data receiver automatically interprets serial strings
- 115VAC and 230VAC available

## Specifications

### Display:

6-digit, 7-segment, 1 in (25.4 mm) Liquid Crystal Display (LCD), optional backlight available (100,000-hour rated life)

### Status Annunciators:

lb, kg, g, gross, net, oz, pcs, tn, zero, count, under, over, OK

### Operating Voltage:

AC models: 115VAC 50/60 Hz standard

DC models: 6.6-13.6 and 12-18VDC; (optional) 230VAC available

### Input Interface:

RS-232, 20 mA active current loop, standard ASCII compatible

### Baud Rate:

Selectable: 1200, 2400, 4800 and 9600

### Operating Temperature:

-13°F to 104°F (-25°C to 40°C)

### Rating/Material:

NEMA 4X FRP or stainless steel

### Weight:

Approximately 4 lb (1.8 kg)

### Warranty:

One-year limited warranty



RD-300 NEMA 4X FRP Enclosure



RD-300 Compact Stainless Enclosure



RD-300 NEMA 4X Stainless Steel Enclosure

DIMENSIONS			
<b>FRP Enclosure</b>			
A	8.00 in (203 mm)	D	4.00 in (101 mm)
B	9.50 in (241 mm)	E	8.75 in (222 mm)
C	6.00 in (152 mm)		
<b>Stainless Steel Enclosure</b>			
A	6.00 in (152 mm)	D	4.00 in (101 mm)
B	9.50 in (241 mm)	E	8.75 in (222 mm)
C	3.87 in (98 mm)		
<b>Compact Enclosure</b>			
A	6.25 in (158 mm)	D	5.25 in (133 mm)
B	9.25 in (234 mm)	E	8.50 in (215 mm)
C	2.00 in (50 mm)		
<b>Panel Mount</b>			
A	5.88 in (149 mm)	D	5.12 in (130 mm)
B	7.88 in (200 mm)	E	7.12 in (180 mm)
C	2.00 in (50 mm)		

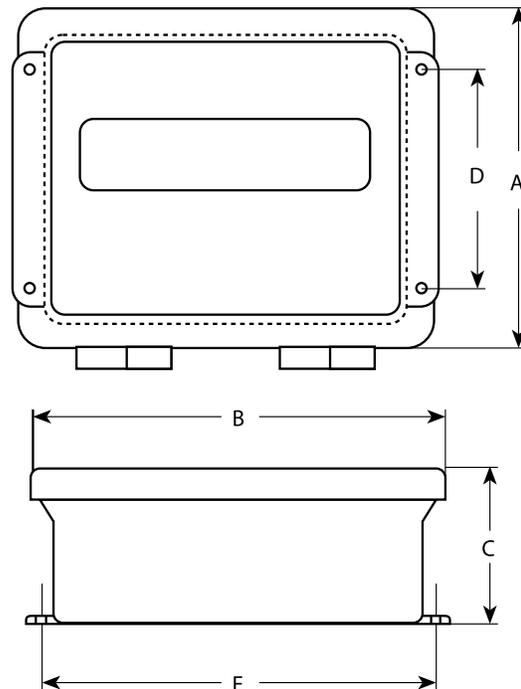

# RD-300

1.0in LCD Remote Display

## Part Number/Price

PART #	DESCRIPTION	EST. SHIP WEIGHT	PRICE
68783	RD-300 AC, compact stainless steel enclosure	5 lb	\$900.00
68782	RD-300 AC, compact stainless steel enclosure with backlight	5 lb	950.00
22530	RD-300 AC, FRP enclosure	5 lb	900.00
22532	RD-300 AC, FRP enclosure with backlight	5 lb	950.00
22534	RD-300 AC, NEMA 4X stainless steel enclosure	8 lb	1,150.00
22536	RD-300 AC, NEMA 4X stainless steel enclosure with backlight	8 lb	1,200.00
22538	RD-300 AC, panel mount	3 lb	850.00
22540	RD-300 AC, panel mount with backlight	3 lb	900.00
34749	RD-300 AC, 230 VAC, FRP enclosure	5 lb	950.00
34750	RD-300 AC, 230 VAC, FRP enclosure with backlight	5 lb	1,000.00

*Specify interfacing indicator when ordering a remote display*

## Options/Accessories

PART #	DESCRIPTION	PRICE
32724	RD-300 AC/DC, board only	\$700.00
32725	RD-300 AC/DC, board only with backlight	750.00
33210	Additional operating manual (RD-300/RD-232)	21.00



# Retail

## Table of Contents

<b>Rice Lake RS-130</b> .....	<b>792</b>
Battery-Operated Price Computing Scale	
<b>Ishida Astra</b> .....	<b>793</b>
Price Computing Scale with Printer	
<b>Ishida Astra Standard Label Formats</b> .....	<b>795</b>
<b>MajorSlice™ 300M</b> .....	<b>796</b>
Manual Slicer	
<b>Intruder™ Cut-Resistant Glove</b> .....	<b>797</b>
<b>QuikSharp™</b> .....	<b>797</b>

**ESPAÑOL** | Visit [ricelake.com/spanish](http://ricelake.com/spanish)  
to see all RLWS materials  
available in Spanish

Product names, logos, brands, and other trademarks featured or referred to within this publication are the property of their respective trademark holders.

# Rice Lake RS-130

Battery-Operated Price Computing Scale

## Standard Features

- Rechargeable battery/charger included
- Toggle between lb/kg/oz\*\*
- Eight PLU keys for direct price lookups
- Cash back calculation
- Large stainless steel platter
- Easy-to-read customer display
- In-use cover
- 89 PLUs for indirect price lookups
- Battery charge indicator
- Customer display
- NTEP Certified Legal for Trade

\*\*Ounces not available in Measurement Canada Approved model

## Specifications

### Capacity/Graduations:

30 lb x 0.01 lb  
15 kg x 0.005 kg

480 oz x 0.2 oz

### Display Items:

Weight: Five digits  
Unit price: Five digits  
Total price: Six digits

### Accuracy:

1/3000

### Display:

Backlight LCD, 0.453 in (11.5 mm) character

### Power Source:

DC 6V/25 mA rechargeable battery with AC adaptor included AC 115V/0.1A (max)

### Battery Life:

100+ run hours

### Weight:

10 lbs (4.5 kg)

### Preset Key:

Eight direct price lookups  
89 indirect price lookups by PLU number

### Dimensions (W x D x H):

Platter: 11.8 in x 9.5 in  
Overall: 12.3 in x 13.0 in x 4.7 in

### Operating Temperature:

32°F to 104°F (0°C to 40°C)

### Output:

PN 89483 RS-232 (Fixed at)  
Baud: 4800  
Parity: None  
Stop bit: 1  
Data bit: 8  
Six-digits weight  
Five-digits unit price  
Six-digits total price

### Warranty:

One-year limited warranty

### Approvals:

NTEP CC 04-067, Class III 3000d  
Measurement Canada Approved: AM-5565



## Part Number/Price

PART #	MODEL	CAPACITY	WEIGHT	PRICE
85608*	RS-130	30 lb x 0.01 lb	12 lb	\$354.00
89483*	RS-130 with RS-232	30 lb x 0.01 lb/ 15 kg x 0.005 kg/ 480 oz x 0.2 oz	12 lb	399.00
94586**	RS-130 (no ounce)	15 kg x 0.005 kg	12 lb	354.00

\*Buy quantity of 5 and get a 50% discount

\*\*Ounces not available in Measurement Canada Approved model

## Options/Accessories

PART #	DESCRIPTION	PRICE
85772	Additional operating manual	\$15.00
85773	Additional calibration instructions	5.00
85711	Additional in-use cover	5.25
47976	Fish platter	95.00
47977	Produce platter	75.00
70056	Cable, RS-232, DB9 (for use with PN 89483) male to female	35.00

## DIMENSIONS

A	13.0 in (330 mm)	C	11.8 in (300 mm)
B	4.7 in (120 mm)	D	9.5 in (240 mm)

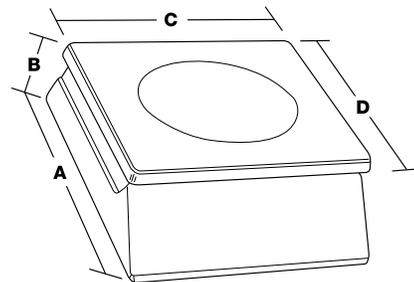

# Ishida Astra

Price Computing Scale with Printer

## Standard Features

- Programmable function keys
- Store up to 2,000 PLUs
- Print speed of 3.15 in (80 mm) per second
- Convenient side-loading label feature
- RS-232 communications (for AstraLink™)
- Proportional tare
- 44 keys store up to 88 presets

## Specifications

### Capacity/Graduations:

30 x 0.01 lb (15 x 0.005 kg)

### Display:

Tare: Four-digits

Weight: Five-digits

Unit/Price: Five-digits

Total Price: Six-digits

### Accuracy:

1/3000

### Label Width:

1.5–2.52 in (38–64 mm)

### Label Length:

1.18–3.35 in (30–85 mm)

### Label Backing Paper Width:

Up to 2.64 in (up to 67 mm)

### Printing Speed:

3.15 in per second (80 mm per second)

### Label Roll Dimensions:

Inside diameter: 1.57 in (40 mm)

Outside diameter: 3.94 in (100 mm)

### Communications:

RS-232 (for AstraLink PLU editor)

Scale data copy function Windows® 95, 98 NT, XP and Windows 7

### Keyboard:

64 keys (88 presets using Mode key)

### Memory Capacity:

256K, 2000 PLUs (30 characters per PLU)

### Approvals:

NTEP CC 00-107

UL listed

### Warranty:

One-year limited warranty



Bench Model



Pole Model

## Part Number/Price

PART #	MODEL	CAPACITY	EST. SHIP WEIGHT	PRICE
	Astra Bench Model	30 x 0.01 lb	32 lb	\$1,530.00
	Astra Pole Model	30 x 0.01 lb	35 lb	1,610.00

## Options/Accessories

PART #	DESCRIPTION	PRICE
66435	Astra CD-ROM (Contains AstraLink™ and AstraLabel™ software programs, operating manual, and label format worksheets)	N/C
66535	RS-232 Null modem 6 ft cable, DB9 female to DB9 female (Astra to PC, Astra to Astra)	\$45.00
47977	Produce platter	75.00
47976	Fish platter	95.00
47341	Continuous roll thermal journal paper, 64 mm W x 50 m L (for reports only)	5.00
66423*	Service manual (lb model)	15.00
66019*	Additional operating manual (lb model)	15.00
47732	2.36 in x 1.73 in (60 mm x 44 mm)	66.00
47733	2.52 in x 1.85 in (64 mm x 47 mm)	66.00
47735	2.52 in x 2.32 in (64 mm x 59 mm)	66.00
47736	Pre-printed safe handling instructions, 2.52 in x 2.32 in (64 mm x 59 mm)	66.00
47743***	Extended text, 2.52 in x 3.34 in (64 mm x 85 mm)	66.00
47745	Pre-printed safe handling instructions on top of label, 2.52 in x 3.34 in (64 mm x 85 mm)	66.00
47762	Non-barcode, 2.52 in x 1.46 in (64 mm x 37 mm)	66.00

Label Stock, please consult factory for case quantity pricing. Examples shown on next page. Labels sold by the case-12 rolls per case.

\* Manuals and software programs can be downloaded at no charge from our website at [www.ricelake.com](http://www.ricelake.com)

\*\*\* Safe handling instructions can also be printed by scale

# Ishida Astra

Price Computing Scale with Printer

RETAIL SCALES

DIMENSIONS			
Pole Type			
B	9.2 in (234 mm)	G	3.1 in (80 mm)
C	16.3 in (415 mm)	H	18.3 in (465 mm)
D	14.0 in (356 mm)	I	6.9 in (176 mm)
F	12.2 in (310 mm)	J	15.7 in (400 mm)

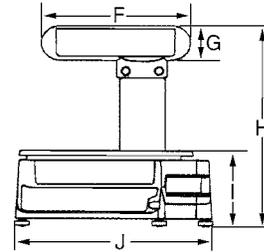
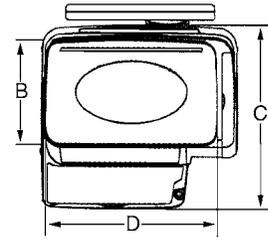

DIMENSIONS			
Bench Type			
A	9.2 in (234 mm)	D	15.7 in (400 mm)
B	16.3 in (414 mm)	E	6.5 in (165 mm)
C	14.1 in (358 mm)		

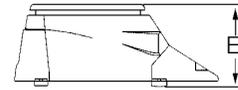
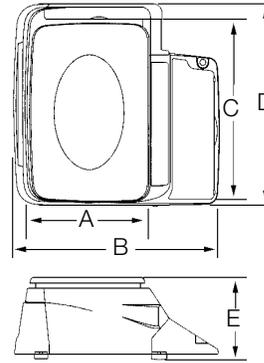

Astralink PLU editing software available



PLU Search Screen



PLU Entry Screen



Program Astra Preset Keys



Preview PLU List Report Before Printing

www.ricelake.com | Phone: 800-472-6703

RICE LAKE



# Ishida Astra Standard Label Formats

**Titles on labels are pre-printed  
(SELL BY, PACKED ON, \$ /LB., NET WT, TOTAL PRICE)**

**Maximum description text per label**

Formats 1-5	1 title line + 2 ingredient lines
Format 6	1 title line + 6 ingredient lines
Format 7	1 title line + 17 ingredient lines
Format 8	1 title line + 6 ingredient lines

## Format 1 47732

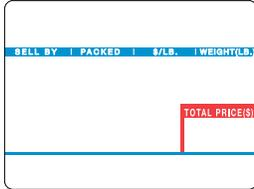

Example

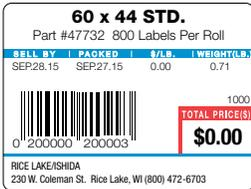

## Format 2 47733



Example



## Format 3 47743



Example



\* Safe Handling information printed by scale

## Format 4 47736

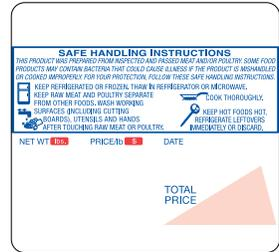

Example



## Format 5 47762

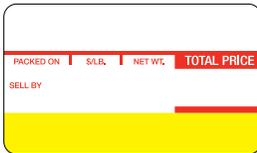

Example

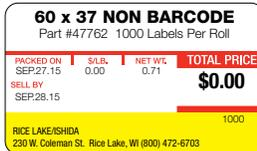

## Format 6 47735



Example

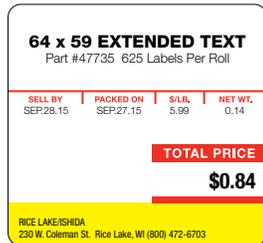

## Format 7 47743



Example



## Format 8 47745



Example



# MajorSlice™ 300M

Manual Slicer

RETAIL SCALES

## Standard Features

- Stainless steel splash and food zones resist corrosion
- Water resistant body and undercarriage
- Exceeds regulations for safety, health and electrical specifications
- Patented VARIOCUT non-slip thickness adjustment locks in precise cut
- Rounded corners, blended weld seams, and open area for easy cleaning
- Removable knife cover and product tray speeds cleaning process
- Detached dual-action sharpener helps to prevent premature knife wear
- Safety lock at index control knob secures gauge plate
- Smooth-moving product carriage reduces the risk of operator fatigue
- Thermal overload protection buttons protect against inadvertent starts after power is restored
- Certified by ETL to the NSF/ANSI Standard 8

## Specifications

### Construction:

304 Stainless Steel, 2.5 mm thick

### Knife:

11.8 in (300 mm)

### Motor:

1/4 HP 0.18 kW

### Water/Dust Resistant:

IP-56

### Index Thickness: VARIOCUT System

0-0.8 in (0-20 mm)

### Sharpener Assembly:

Independant detached, dual action

### Dimensions: Overall:

18.6 H x 28.0 L x 19.0 in W (473 H x 712 L x 483 mm W)

### Dimensions: Foot to Foot

22.0 L x 15.4 in W (558 L x 390 mm W)

### Sliding Carriage:

High tech with stainless guide system

### Shipping Dimensions:

23.6 x 31.5 in (600 x 800 mm)

### Weight:

101 lb (46 kg)

### Power:

120 V, 60 C, 1 PH

### Certifications:

ETL Listed

Certified by ETL to NSF/ANSI Standard 8

### Warranty:

One-year limited warranty

## Part Number/Price

PART #	MODEL	KNIFE	WEIGHT	PRICE
131118	300M Model Manual Slicer	11-3/4 in (300 mm)	150 lb (68 kg)	\$3,216.00



## APPROVALS



Detached Sharpener



## Options/Accessories

PART #	DESCRIPTION	PRICE
78717	Cut-resistant glove small	\$15.00
78718	Cut-resistant glove medium	15.00
78719	Cut-resistant glove large	15.00
133086	Stick-resistant PTFE knife 300M Model	472.00
Consult	Stainless steel knife 300M Model	465.00
151477	Food-grade lubrication, 4 oz. plastic bottle	10.00
77933	Food grade grease, 14 oz cartridge	20.00

### Manuals and Service Tools

130818	Additional operators manual	15.00
--------	-----------------------------	-------

### Replacement Parts

133082	Replacement sharpener 300 Model	265.00
133084	Replacement knife 300 Model	433.00

www.ricelake.com | Phone: 800-472-6703

RICELAKE

796

# Intruder™ Cut-Resistant Glove

## Standard Features

- Stainless steel core fiber
- Withstands high pressure cleaning
- Stain and odor resistant

FDA/USDA approved materials

## Specifications

### Construction:

37 AWG solid 304 stainless steel NOM OD: 0.0045  
 1000 Denier polyester strength member NOM OD: 0.10  
 8 mils non-toxic PVC jacket

## Part Number/Price

PART #	DESCRIPTION	SIZE	WEIGHT	PRICE
78717*	Cut-Resistant Glove	Small	1 lb	\$15.00
78718*	Cut-Resistant Glove	Medium	1 lb	15.00
78719*	Cut-Resistant Glove	Large	1 lb	15.00

**Consult factory for bulk pricing**

\* *Glove is cut-resistant not cut-proof or point puncture resistant and should not be used with moving or serrated blades*



**CAUTION** *Glove is cut-resistant not cut-proof or point puncture resistant and should not be used with moving or serrated blades*

# QuikSharp™

## Standard Features

- Tungsten carbide sharpener
- Ceramic honing rods
- Reversible blades

## Specifications

### Blades:

Tungsten carbide

### Honing Rods:

Ceramic

### Dimensions (L x W x H):

6 x 0.75 x 2.5 in  
 (152.4 x 19.05 x 63.5 mm)

## Part Number/Price

PART #	DESCRIPTION	PRICE
78720	Intruder™ QuikSharp™ Complete Knife Sharpening System	\$12.00





# Scanners

## Table of Contents

<b>Datalogic® QuickScan®</b> <b>QD2100</b> .....	<b>800</b>
Linear Imager Handheld Scanner	
<b>Datalogic® PowerScan®</b> <b>PD7100 Series and 7000 2D</b> .....	<b>801</b>
<b>Datalogic® PowerScan® RF</b> <b>PM8300 Series</b> .....	<b>802</b>
<b>Motorola® DS457</b> .....	<b>803</b>

**ESPAÑOL** | Visit [ricelake.com/spanish](http://ricelake.com/spanish)  
to see all RLWS materials  
available in Spanish

Product names, logos, brands, and other trademarks featured or referred to within this publication are the property of their respective trademark holders.

# Datalogic® QuickScan® QD2100

Linear Imager Handheld Scanner

SCANNERS

## Standard Features

- Datalogic Green Spot for good read feedback
- Ergonomic “aim and shoot” design
- Reliable and durable, providing long lasting performance

## Depth-Of-Field

Printing resolution, contrast, and ambient light dependent

DENSITY	RANGE	
4 mils	0.0 in to 4.3 in	(2.0 to 11 cm)
5 mils	0.6 in to 6.0 in	(1.5 to 15.0 cm)
10 mils	0.3 in to 15 in	(0.8 to 38.0 cm)
20 mils	1 in to 26 in	(2.5 to 65 cm)

## Specifications

### Light Source:

Red LED 617 mm

### Decode Capabilities:

UPC A, E/EAN 8, 13/JAN 8, 13 (including add-ons P2/P5, Code128), Code 128, Code 93, Pharmacode 39, Code 39, Codabar, Interleaved 2 of 5, Industrial 2 of 5, Matrix 2 of 5, RSS 14, RSS-14 Stacked, RSS Expanded, RSS Limited, MSI/Plessey, UK/Plessey, Telepen, Code 16K, Code 11, PDF417 w/audio assist

### Dimensions:

6.7 x 2.8 x 2.6 in  
(17.0 x 7.1 x 6.6 cm)

### Weight:

121.9g (4.3oz)

### Read Rate:

270 reads/sec

### Communications:

RS-232  
DB9 female connector  
USB  
Keyboard wedge  
Wand multi-interface

### Operating Temperature:

32°F to 122°F (0°C to 50°C)

### Humidity:

5% to 95% non-condensing

### Shock Tolerance:

Withstands repeated drops onto concrete from 5ft (1.5m)

### Ingress Protection Rating:

IP42

### Warranty:

Five-year limited warranty



## Part Number/Price

PART #	DESCRIPTION	WEIGHT	PRICE
109596	QuickScan, QD2100, RS-232 6ft cable and stand	4 lb	\$285.00
109597	QuickScan, QD2100, USB cable	4 lb	258.00
109598	QuickScan, QD2100, keyboard wedge cable	4 lb	258.00
114796	QuickScan, QD2100, RS-232 cable, stand, 8-Pin DIN cable for use with Digi® counting scales	4 lb	400.00
121495	QuickScan, QD2100, RS-232 cable, stand, 9-Pin quick connect (supplies power from Counterpart Digital I/O)	4 lb	335.00

## Options/Accessories

PART #	DESCRIPTION	PRICE
109599	Power supply, desktop 5V, 12 watt	\$51.00
112447	RS-232 6 ft cable coiled 9-Pin female	50.00
85022	PS/2 to AT adaptor 5-Pin DIN male 6-Pin DIN female 6 in tail	12.00
114797	RS-232 cable with 8-Pin DIN cable (for use with Digi Counting Scales)	95.00
125744	RS-232 cable 9-Pin powered cable to blunt end with plug in (for use with Counterpart®)	50.00

www.ricelake.com | Phone: 800-472-6703

RICE LAKE

800

# Datalogic® PowerScan® PD7100 Series and 7000 2D

## Standard Features

- IP65 sealing rating
- Durable—tested to 50 drops of 2m/6.6ft
- 25 kV Electrostatic protection
- Datalogic Green Spot and loud beeper for good read feedback
- Aladdin software for configuration

## Specifications

### Dimensions:

8.0 x 3.0 x 4.5 in  
(20.3 x 7.6 x 11.4 cm)

### Weight:

280.0g (9.9 oz)

### Display:

LED

### Operating Temperature:

-22°F to 122°F (-30°C to 50°C)

### Storage Temperature:

-22°F to 122°F (-40°C to 70°C)

### Humidity:

5% to 95% non-condensing

### Light Source:

Aiming 630 - 680 mm VLD

### Communications:

Keyboard wedge, USB or RS-232

### Bar Codes For PD7000-2D:

ID, stacked 2D (PDF417, Micro PDF and Matrix 2D codes)

### Ingress Protection Rating:

IP65

### Drop Resistance:

6.6ft (2m)

### Warranty:

Three-year limited warranty



## Part Number/Price

PART #	DESCRIPTION	WEIGHT	PRICE
108215	Scanner, PD7130 YB multi-interface, requires cable - ordered separately	4 lb	\$550.00
108216	Scanner kit, PD7130 YBK2 scanner and RS-232 cable - included	4 lb	620.00
126366	Scanner kit, 7000-2D scanner and RS-232 cable	4 lb	995.00

## Options/Accessories

PART #	DESCRIPTION	PRICE
114372	Kit, universal mount, Datalogic # 110111 PD7100 Series	\$20.00
108217	RS-232 cable, CAB-434, 8 ft, 9-Pin female coiled, PD7100 Series	70.00
126367	RS-232 cable, DB9S, coiled 8 ft, 7000 2D Series	70.00
108218	USB cable, CAB-439 for use with PD7130 only	70.00
108219	Keyboard wedge cable, CAB-437, PD7100 Series	70.00
108220	Power supply, desktop 5 volt, 12 watt, PD7100 Series	45.00
41276	DB9-M Pin blunt end cable	65.00
Consult	USB straight, CAB-465 7000 2D	Consult
Consult	RS-232 coiled 12 ft, CAB 467	Consult
Consult	RS-232 coiled 15 ft, CAB 486	Consult
Consult	USB, 8-0734-08	Consult

# Datalogic® PowerScan® RF PM8300 Series

## Standard Features

- IP65 rating
- Wireless operation
- Operates up to 10 hours on a single charge
- Scanner and base station are IP64
- Green spot - good read feedback
- Polycarbonate molded with rubber
- Multi-point operation allows for multiple scanner communications to a single base station

## Specifications

### Dimensions:

Scanner: 8.4 x 4.5 x 2.8 in  
(212 x 109 x 71 mm)  
Base Station: 10.5 x 3.5 x 2.5 in  
(266.7 x 88.9 x 63.5 mm)  
(width is 4.2 in/106.68 mm including mounting knobs.)

### Weight:

Scanner: 13.9 oz (395 g)  
Base Station: 16 oz (454 g)

### Display:

LCD: 4 lines x 16 characters

### Light Source:

VLD between 630-380 nm

### Base Station:

US: 110V±10%, 60 Hz

### Communications:

Host: RS232 with DB9 S, P/S and 12 ft cable.  
KBW (keyboard wedge) with P/S and 6 M Din, coiled cable 12 ft.  
USB, 12 ft coiled cable

### Frequency Range: (varies by country)

915 MHz

### Operating Temperature:

-4°F to 122°F (-20°C to 50°C)

### Storage Temperature:

-4°F to 158°F (-20°C to 70°C)

### Ingress Protection Rating:

IP65  
Scanner and base station: IP64

### Humidity:

90% non-condensing

### Drop Resistance:

2 m

### Battery Type:

2150 Lithium-ion battery pack

### Electrical:

Complies to C-CSA-US  
(60950 Canada and USA)



## Part Number/Price

PART #	DESCRIPTION	WEIGHT	PRICE
104967	PowerScan RF Scanner with battery, SR, 910 MHz for RS-232/ keyboard wedge/wand emulation interfaces (requires cable and base station)	4 lb	\$1,050.00
104968	PowerScan RF Base Station, 910 MHz for RS-232/ keyboard wedge/wand	5 lb	420.00
82281	PowerScan Quick Scan US, AC power adapter	3 lb	30.00

## Options/Accessories

PART #	DESCRIPTION	PRICE
104969	Cable, Wedge, Y, 6-Pin mini DIN, 5-Pin D/N, universal adapter cable	\$50.00
108217	Cable, RS-232, 9-Pin D-sub, 8 ft	70.00



## Standard Features

- High speed omnidirectional scan pattern
- Rugged, durable housing
- Sealed to IP54 standards
- Reads 1D and 2D symbols
- Supports 123Scan2 configuration tool
- Enables rapid and easy customized set-up through a free, wizard-based PC software tool
- Scans any bar code on paper, mobile phones and computer displays

## Specifications

### Dimensions:

1.15 (H) x 2.3 (L) x 2.44 in (W)  
2.92 (H) x 5.84 (L) x 6.2 cm (W)

### Weight:

3.9 oz (111 g)

### Power Maximum:

5VDC +/- 10% at 450 mA

### Performance Characteristics:

Sensor Resolution 752 (H) x 480 (V) gray scale  
Imager Field of View DS457 SR: 39.6° horizontal, 25.7° vertical  
Aiming Element 655 ± 10 nm (VLD)  
Illumination Element 625 ± 5 nm (LED)

### Symbology Decode Capability:

1D All major 1D bar codes  
2D PDF417, DataMatrix, QR Code, Aztec,  
Composite Codes and MaxiCode  
Postal US Postnet, US Planet, UK Postal, Australian  
Postal, Japan Postal

### Communications:

Interfaces Supported 9-Pin male D-sub USB (full speed) and TTL level RS-232 with RTS and CTS

### Operating Temperature:

-4° to 122°F (-20° to 50°C\*) (\* Laser aimer disabled above 113°F /45°C)

### Storage Temperature:

-40° to 158°F (-40° to 70°C) Storage: 85% RH, non-condensing at 70°C

### Ingress Protection Rating:

IP54

### Humidity:

95% RH, non-condensing at 50°C

### Drop Resistance:

Withstands multiple 30 in (76 cm) drops to concrete

### Image File Formats :

BMP, TIFF, JPG

### Regulatory:

Electrical Safety ETL, VDE, CETL, EN60950, Ctick, VCCI  
Laser Classification Intended for use in CDRH Class II/IEC 825 Class I devices  
EMI/RFI FCC Part 15 Class B, ICES-003 Class B, CISPR22 Class B

### Warranty:

Three-year warranty against defects in workmanship and materials



## Part Number/Price

PART #	DESCRIPTION	WEIGHT	PRICE
154077	Motorola DS457-SR (scanner 5VDC ± 10% at 450 mA requires power source)	4 oz (111 g)	\$600.00

## Options/Accessories

PART #	DESCRIPTION	PRICE
97479	Cable assembly, DB9F to blunt end	\$55.00



# Software/Traceability Systems

## Table of Contents

<b>VIRTUI<sup>2</sup></b> ® .....	<b>806</b>
PC-Based HMI for iQUBE <sup>2</sup> ®	
<b>Interchange</b> .....	<b>807</b>
920i® Database Management Software	
<b>OnTrak</b> ™ .....	<b>808</b>
Truck Data Management Software	
<b>TransAct</b> ® LE/ <b>TransAct</b> ®/ <b>TransAct</b> ® Plus ..	<b>810</b>
Truck Data Management Software	
<b>CRS</b> ™ <b>Certificate Retrieval System</b> .....	<b>812</b>
Version 3	
<b>TRACER</b> ® .....	<b>813</b>
<b>WeighVault</b> ® .....	<b>814</b>
<b>WinWedge</b> ® <b>TAL Software</b> .....	<b>815</b>
Bar Code Label Software	

**ESPAÑOL** | Visit [ricelake.com/spanish](http://ricelake.com/spanish)  
to see all RLWS materials  
available in Spanish

Product names, logos, brands, and other trademarks featured  
or referred to within this publication are the property of their respective trademark holders.

## VIRTUI2®

PC-Based HMI for iQUBE2®

VIRTUI is a Windows®-based desktop application that works with iQUBE2 to replicate simple indicator functionality ideal for system integrators and OEMs wanting to provide a PC-based solution. Load cells are individually monitored and calibrated, making setup easy.

### Standard Features

- Web browser-based iQUBE® cell status
- Configurable display options
- Up to four scale systems and one total scale
- Virtual front panel consists of display and five button keypad
- Up to four digital I/O (provided by iQUBE2)
- Primary/secondary units configuration (lb, kg, short tons, metric tons, none)
- RS-232 communications at up to 460 Kbps
- Electronic Data Processing (EDP) port over RS-232 and TCP/IP
- Printer port for output-only, simplex communications
- Two print formats
- Provides for iQUBE2 configuration
- Supports iQUBE2 diagnostics with configurable error reporting
- Peak weight history
- Recalibration notification
- Provides local and remote reporting of diagnostics and error conditions
- Concentrated load capacity (CLC)
- Section capacity

### Specifications

#### Minimum System Requirements:

Windows® XP™ or greater  
 Internet Explorer 6.0 SP1  
 .NET Framework 1.1  
 128 MB Ram  
 30 MB free hard drive space  
 Serial port for connection to iQUBE  
 Additional serial ports are required for connections to printers/remote displays

#### Status Annunciators:

Units (lb, kg, short tons (tn), metric tons (t), NONE) Gross/Net, Motion, Center of Zero

#### Approvals:

NTEP CC 04-058 Classes III and IIII at 10,000d

### Part Number/Price

PART #	DESCRIPTION	PRICE
108435	Virtual Indicator DEMO CD	N/C
108436	Activation Part Number Requires Machine ID and Customer's email address	\$500.00



# VIRTUI<sup>2</sup>

### APPROVALS



Load Cell Configuration



Scale Configuration

# Interchange

## 920i® Database Management Software

Used to setup a custom job file for each 920i database you need to export. Manually or automatically run the job file by setting a predetermined time. Windows Task Scheduler can run the job file before you get to work and have an uploaded Excel spreadsheet in your email in box.

### Standard Features

- Setup using an Export Job Wizard
- Connect using RS232, RS485 or Ethernet TCP/IP
- Program will connect to the 920i and upload the current database structure
- Select the desired database
- Exports tab delimited text file, xml, xls or htm

### Specifications

#### Minimum System Requirements:

- Windows XP or greater
- Internet Explorer 7.0 SP1
- .NET framework 1.1

### Part Number/Price

PART #	DESCRIPTION	PRICE
72809	Interchange database software	\$295.00



Export or Import Data

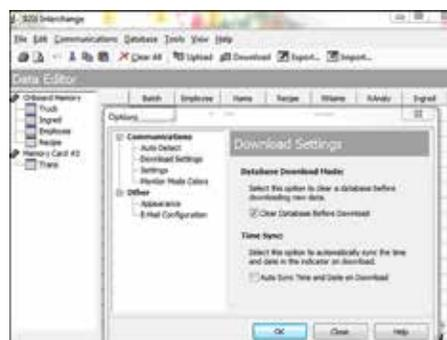

Communication Settings for Download

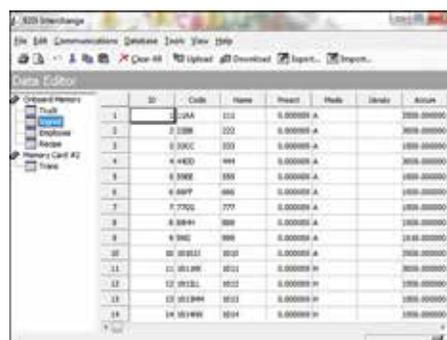

Database Editor

### Standard Features

- Supports Windows XP SP3 (32-bit), Vista SP 2 (x86 or x64), Windows 7 (x86 or x64) and Windows 8 Systems
- SQL Server 2005 Express Client/Server Database
- Comprehensive report filters
- User and administrator filters
- Backup and restore via included SQL Server Management Studio Express
- Unlimited charge / discount per product
- Ship or receive mode for each transaction
- Exclusive database for: Customer, Hauler, Truck, Product, Job, Price/Discount, Tax, Transaction
- Ethernet TCP/IP or RS-232 connectivity
- Supports VIRTUi/VIRTUi2 or Rice Lake weight indicators

### Optional Features

- Interface to non-Rice Lake weight indicators
- Custom reports
- Database configuration
- Field installation and training
- Factory phone support

### Database Features

<b>Transaction:</b>	<b>Product Charge:</b>	Customer ID	Line 2
Truck ID	Product	Job #	Line 3
Customer ID	Charge	Product #	City
Job	Job	Hauler #	State
Product	Job ID	<b>Hauler:</b>	Postal Code
Weigh In TandD	Job Name	Name	Country
Weight Out	Job Closed	Address	<b>Customer:</b>
TandD	Customer #	Phone	Customer ID
Gross Weight	<b>Job Price:</b>	Fax	Name
Tare Weight	Job #	Contact Name	Bill to Address
Net Weight	Product #	<b>Weigh In:</b>	Ship to Address
Tare Type	Amount	Truck ID	Phone
Units	Ordered	Customer ID	Fax
Void	Amount	Job #	Contact Name
Ship Mode	Delivered	Product #	<b>Hauler:</b>
<b>Transaction Charge:</b>	Discount	Weight In TandD	Name
Transaction #	<b>Truck:</b>	Weight Value	Address
Charge Name	Truck ID	<b>Charge:</b>	Phone
Charge Rate	Tare	Charge Name	Fax
Charge Type	Are Acquired	Charge Rate	Contact Name
<b>Product:</b>	Tare Expiration	Charge Type	Inactive
Product Name	Tare Type	<b>Discount</b>	Discount Level
Product ID	Name	<b>Schedule:</b>	<b>Customer Charge:</b>
Price	Minimum Weight	Name	Customer ID
Description	Maximum Weight	Rate	Charge #
Minimum Charge	Radio Tag ID	<b>Address:</b>	
		Line 1	

### Specifications

#### System Requirements:

- Windows® XP (SP3) / VISTA (SP2) / Windows 7/8
- 1.5 GHz processor or higher
- 512 (minimum) of RAM
- 100 mb hard drive (minimum)

#### Databases:

- 4 GB max database size when using included MS SQL Server 2005 Express, Unlimited with standard version of MS SQL Server.
- Backup and restore via included SQL Server Management Studio Express

#### Communications:

- Support for multiple printers
- Supports all Rice Lake indicator interfaces
- Supports VIRTUi/VIRTUi2 interface
- Optional Drivers available for non-Rice Lake weight indicators

#### Transaction Ticket:

- User defined ticket formatting

#### Reports:

- Comprehensive report filters
- Optional custom reports

#### Export Data:

- File transfer via XML transaction export reports can be saved as PDF/XLS

#### Transaction Calculations:

- Unlimited product prices and discounts
- Tax calculations

#### Software Support:

- Database configuration, field installation, and training available
- Phone support packages available
- Contact Rice Lake for further options

#### Approvals:

- NTEP CC 05-107



Weigh Scale

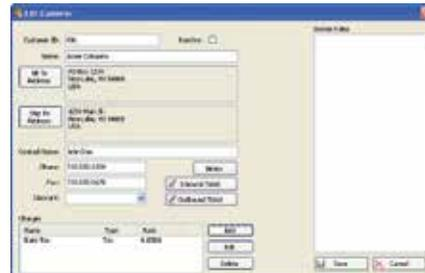

Customer Account Information

### APPROVALS



## Part Numbers/Price

PART #	DESCRIPTION	PRICE
104787	OnTrak activation code	\$1,395.00
101062	OnTrak CD/ROM*	80.00

OnTrak trial at [www.ricelake.com/ontrak](http://www.ricelake.com/ontrak)

## Options/Accessories

PART #	DESCRIPTION	PRICE
Consult	Non-Rice Lake indicator interface	\$195.00
Consult	Custom reports	95.00/hour
Consult	Database configuration	95.00/hour
Consult	Field installation	1,080.00/ day plus expenses
104789	Phone support 1 hour	95.00
104790	Phone support 10 hours	895.00
104791	Phone support 25 hours	2,000.00
104792	Phone support 50 hours	3,500.00
101003	Additional OnTrak manual	55.00
151626	Camera, Ethernet TCP/IP (additional software and power injector required)	1,465.00
131605	Power supply, injector (enclosure sold separately)	155.00
23143	Power cord for 131605	11.00

# TransAct® LE/TransAct®/TransAct® Plus

Truck Data Management Software

## Standard Features

### TransAct LE/TransAct/TransAct Plus

- Intuitive menu-driven programs
- Ticket editing, voiding, reprinting with the Quickscan utility
- Report to screen, printer or export
- Password protection
- Easy-to-use graphic interface
- Full mouse and keyboard support
- Interfaces to ticket, tape, dot-matrix and laser printers (TransAct LE only)
- Unlimited configurable ticket formats (TransAct LE only)
- Fault-tolerant data recovery to protect from system crashes
- Bar code, magstripe and RFID interface
- Full database backup and purge functions
- Truck "Overweight" warning
- Predetermined, keyboard and automatic tare entry
- Transaction importing/exporting, for long distance transfers in non-networking applications

### TransAct/TransAct Plus

- Three configurable tares
- Four configurable categories
- Configurable product rates
- Multiple scale operation
- Multiple transactions per ticket
- Networkable
- Job table for contract purchases
- Full reporting by account, revenue, tonnage, material and transaction (TransAct Plus only)
- Accounts payable and receivable (TransAct Plus only)
- Prints customer invoices and statements with detailed transaction information (TransAct Plus only)
- Expandable reporting features (TransAct Plus only)
- Credit weight limits (TransAct Plus only)
- Aging report showing current and extended balance 30, 60, and 90 days (TransAct Plus only)

### TransAct 5.5.11 Features

- 32-Bit Application
- Faster more reliable Access 2003 database
- Fewer compatibility issues running under Windows XP and future operating systems
- Preemptive multitasking enables greater application performance
- More organized and flexible Weigh Form Stand-Alone Reporting Tool (using Crystal 9.0)
- More report types and more flexible reports
- Reports can be saved in PDF and plain text formats
- Reports can be saved as Excel spreadsheets
- Reports can be saved as comma or tab delimited separated ASCII formats
- Group Tree - quickly navigate to a specific major sort order section
- Printer Setup button can be used to select a printer other than the default windows printer
- Check box to allow for page breaks between major groupings
- Freight
- Individual or Global Hauler Account freight table
- Available Freight charge field for each Job Item - overrides the Hauler Account freight table
- Implementation of Zones and Hauler Payables
- Expanded tax structure
- Generate an unlimited list of Tax Authorities (examples: Federal (5%), State (.5%), City (.2%), County (.1%))

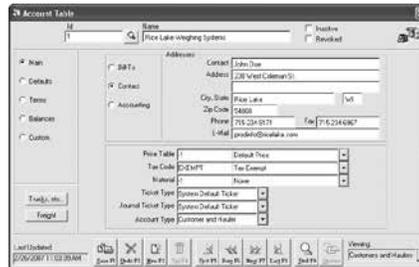

Customer Account Table



Truck/Container Cash Transaction

## APPROVALS



## Standard Features

- Generate unlimited tax codes from the list of tax authorities up to five tax authorities can be selected for each tax code (examples: Federal + State = 5.5%, Federal + State = 5.7%)
- Detailed tax reports by each tax authority
- Updated accounting features (TransAct Plus only)
- Invoice processing is separate from statement processing
- Two invoice options available (open item, balance forward)
- Retained the Rev. 3 combined invoices/statement option (balance forward list ticket)
- Invoice and statement printing options (print summary report, print detailed report)
- Invoice and statement reprinting options (by range of invoice numbers or date) (reprint invoice, reprint summary report, reprint detailed report)



# TransAct® LE/TransAct®/TransAct® Plus

Truck Data Management Software

## Specifications

### System Requirements:

Windows® XP 32-bit with service pack 2 or later  
Windows 7 service pack 1 or later  
Windows 8

### Hardware:

Intel® AMD® Processor, 1 GHz or greater  
1 GB of Ram or greater  
1 GB available storage space (data dependent)

### Databases:

Virtually unlimited with user-definable categories.  
Automatic journaling with automatic rebuild after crash or power interrupt.

### Communications:

Support for two printers with selectable drivers for most popular printers.

### Transaction Ticket:

Configurable weigh-in and weigh-out ticket formats, complete selection of variables and data types.

### Reports:

Full reporting capabilities by account, vehicle, material, hauler, area, ticket, truck, container, trailer or date.  
Age reports 30, 60, 90 days.

### Export Data:

Reports can be exported via tab-delimited file format.  
Export/Import function for transferring transaction data in non-networking applications.

### Transaction Calculations:

Definable product rates, charges, taxes, and customer discounts.  
Configurable percentage weight reductions for moisture and dockage.

### Accounting:

Full accounting capabilities  
Accounts Payable  
Accounts Receivable  
Balance/Reconciliation

### Software Support:

Rice Lake Weighing Systems offers field software support for TransAct LE/TransAct/TransAct Plus. Contact our service department for software support. Software support is a chargeable service.

### Approvals:

NTEP CC 97-034

## Part Numbers/Price

PART #	DESCRIPTION	PRICE
79079	TransAct LE version 5.5.11	\$1,385.00
43898	TransAct version 5.5.11	2,345.00
98089	Additional seat TransAct 5.5.11 (must be purchased with original 5.5.11)	965.00
43899	TransAct Plus version 5.5.11	4,645.00
98090	Additional seat TransAct Plus 5.5.11 (must be purchased with original 5.5.11)	1,785.00

\*TransAct demos can be downloaded from our Web site at [www.ricelake.com](http://www.ricelake.com)

## Options/Accessories

PART #	DESCRIPTION	PRICE
15547	Blunt end, 25-pin D-sub male RS-232 serial interface cable	\$65.00
<b>Interfaces to: UMC444, UMC555, UMC600, IQ 700, IQ plus® 310A, 355, 390-DC, 510, 590-DC, 710, 800, 810, 520 and 920i</b>		
42745	pcANYWHERE® for Windows®, host and remote version	295.00
50270	Additional operating manual	25.00
98091	Upgrade from TransAct LE to TransAct 5.5.11	Consult
98092	Upgrade from TransAct LE to TransAct Plus 5.5.11	Consult
98093	Upgrade from TransAct to TransAct Plus 5.5.11	Consult
Consult	Quickbooks® interface for TransAct 5.5.11	Consult
Consult	Quickbooks® interface for TransAct Plus 5.5.11	Consult
Consult	Sage Interface (formerly Peachtree) for TransAct 5.5.11	Consult
Consult	Sage Interface (formerly Peachtree) for TransAct Plus 5.5.11	Consult
98103	Two hours configuration installation and training service	385.00
98104	Four hours configuration installation and training service	765.00
98105	Eight hours configuration installation and training service	1,525.00

# CRS™ Certificate Retrieval System

Version 3

## Standard Features

- Web and PDA-based application
- Paperless storage of weighing system and measurement instrument calibration data
- Secure online asset maintenance history
- Improved ISO/IEC 17025 conformity
- Maintenance traceability
- Tracks asset location within a facility
- Provides documented inventory of customer assets
- Eliminates unnecessary calibrations
- Ensures all appropriate scales are calibrated
- Identifies product replacement opportunities
- Provides consistency of calibration procedures
- Provides traceability of service procedures
- Reduces service technicians' calibration time by 33%
- Flexible configuration enables dealer to meet customer needs
- Testing lab balances, industrial, truck and rail scales
- Reduces technician training time and expense
- Measurement Uncertainty
- Module available for generic devices



## Specifications

### Web System Requirements - Administrator:

Internet Explorer® 6.0 or higher

### System Requirements - P.C.:

Any internet connection, ActiveSync 4.5 or Windows Mobile Device Center, Windows XP, Vista, 7 and 8 are all supported

### System Requirements - PDA:

Windows® Mobile 5.0™ or above with Intel® Xscale® processor with 64 MB of RAM (recommended).

### PDA Recommendation:

Recommended PDAs include the iPAQ™ 111 by Hewlett-Packard™, for new systems Socket Somo 650 is available

## Part Number/Price

PART #	PRODUCT	DESCRIPTION	PRICE	RENEWAL PART #	PRICE
88277	CRS Universal Program	One location system	\$6,100.00	88281	\$2,000.00
88269	CRS Locations	Two location system	9,400.00	88273	2,200.00

## Accessories Needed

PART #	PRODUCT	DESCRIPTION	PRICE
115702	PDA license	Initial license fee, one technician	\$400.00
115703	Pocket CRS/mobile phone	Additional licenses per technician	250.00
124822	PDA, Socket Somo	PDA, case, charger, memory card	670.00

## Options

PART #	PRODUCT	DESCRIPTION	PRICE	RENEWAL PART #	RENEWAL
118459	Generic Device Module	Performing non-scale calibrations	\$2,000.00	118460	\$200.00
118461	CRS Additional Locations	One charge per additional location	3,300.00	118460	200.00
Consult	Calibration forms	Additional forms	220.00 each		

## Measurement Uncertainty

Calculations are derived using the standard CRS formula, and is unable to be modified

$$(\text{Sqr}(\{\text{SP}\}^2 + \{\text{Udr}\}^2 + \{\text{Us}\}^2 + \{\text{Uw1}\}^2 + \{\text{Uw2}\}^2 + \{\text{Usub}\}^2 + \{\text{Uunk}\}^2 + \{\text{Uv}\}^2 + \{\text{Ur}\}^2 + \{\text{Usw}\}^2)) * 2$$

VARIABLE	EQUATION	RESTRICTED USE
SP	(MinScaleDivision / Sqr(3))*0.5	
Udr	(MinScaleDivision / Sqr(3))*0.5	
Ur	DirectValue	
Us	TestWeightTolerance / Sqr(3)	
Usub	(MinScaleDivision / Sqr(3))*0.5	Industrial
Usw	DirectValue	
Uunk	(MinScaleDivision * DivM) / Sqr(3)	
Uv	DirectValue	
Uw1	(LoadTestMax - LoadTestAsLeft) / Sqr(3)	HeavyCapacity
Uw2	(StrainMax - StrainActual) / Sqr(3)	HeavyCapacity

## Specifications

In the United States, the ability to trace any ingredient from its origin, through each step in the manufacturing process, to its final destination is a necessity as mandated by Section 306 of the Bioterrorism Preparedness Act of 2002. The Tracer® Solution complies with this Act by electronically capturing data so that producers can keep detailed records on the origin and destination of each individual ingredient. The Tracer Solution also improves accuracy, product quality and reduces costs by ensuring that every recipe is weighed within desired tolerance and no ingredient is omitted. Due to the variety of site configurations, please consult factory to discuss application requirements and to schedule a confidential site evaluation.



## Standard Features

- Specialized PC software makes data entry easy
- Boost product ID storage to nearly limitless potential, and manage as many scales as necessary
- Eliminates front-panel entry of ID parameters
- Quickly program, edit and manage scales and each unique product ID right from your PC
- Stores the details of each transaction for either a single scale or multiple scales
- Collects data as transactions occur and provides detailed transaction and productivity reports
- Allows users to add, edit and access IDs over a network connection
- Reports can be exported into word processing, spreadsheet or PDF formats

## Specifications

### Minimum System Specifications:

- CW-90X or Counterpart
- 800+ MHz Intel® compatible processor
- 1 GB of RAM
- 750 MB hard drive space
- Microsoft® XP SP3 (32-bit), Windows® Vista (x86 or x64), Windows® 7 (x86 or x64), Windows 8 (32-bit)
- TCP/IP connections to a CW-90, CW-90X or Counterpart

### Recommended System Specifications:

- 1.0 GHz Intel compatible processor
- 2 GB of RAM
- 4 GB of hard drive space
- Microsoft® XP SP3 (32-bit), Windows® Vista (x86 or x64), Windows® 7 (x86 or x64), Windows 8 (64-bit)
- TCP/IP connections to a CW-90, CW-90X or Counterpart

### Network Requirements:

- The PC running the WeighVault service must have a static IP address
- Known IP address and subnet of the host PC; if connecting via WLAN, known network SSID and security settings (pass keys and phrases)
- Network policy must allow passwords of six characters



## Part Number/Price

PART #	DESCRIPTION	PRICE
117358	Software package, WeighVault for CW90/90X	\$200.00
125546	Software package, WeighVault for Counterpart	200.00

## Counterpart Functions Only

### Data Registers:

- ID code [32 characters]
- Unit weight [6 places]
- Tare weight [6 places]
- Units field
- Parts name [32 characters]
- Part Description [32 characters]
- Lot number [32 characters]
- Location [12 characters]
- Inventory Quantity [7 characters]

### Reports:

- Part
- Inventory
- Activity
- Location

## CW-90/90X Functions Only

### Part Fields:

- Product ID [4 characters]
- Two Descriptions Fields [32 Characters each]
- Target
- Tare
- Over
- Under
- Units

### Reports:

- Transaction
- Productivity

# WinWedge® TAL Software

Bar Code Label Software

## Standard Features

- Input scale or instrument data directly into Excel®, Access®, statistical software, LIMS, MIMs, any Windows® application
- Transfers RS-232 data quickly, accurately and formatted to your exact specifications
- Powerful DDE options for collecting data from multiple devices simultaneously
- Extremely easy to set-up and use
- 32 Pro, TCP/Wedge additional features:
- Support for even the most complex devices and serial I/O with advanced data parsing, filtering, formatting and translation
- Support for TCP/IP as well as RS-232 data collection and I/O
- More advanced device control options
- Additional features such as math functions and virtual instrument mode
- Five RS-232 and TCP/IP communications software products provided free of charge

## Specifications

### System Requirements:

- Any version of Windows®
- Any Windows PC
- 4 MB of RAM
- 2 MB of hard disk space

### Communications:

WinWedge can collect data on any serial port (RS-232 or RS-485) and even on multiple ports simultaneously. Also supports full device control.

### Software Support:

Rice Lake Weighing Systems offers field software support for our software packages. Contact our Service Department for software support. Software support is a chargeable service.

## Part Number/Price

PART #	DESCRIPTION	PRICE
75351	WinWedge® TAL software, 32 Std	\$325.00
72304	WinWedge® TAL software, 32 Pro, TCP/Wedge	545.00

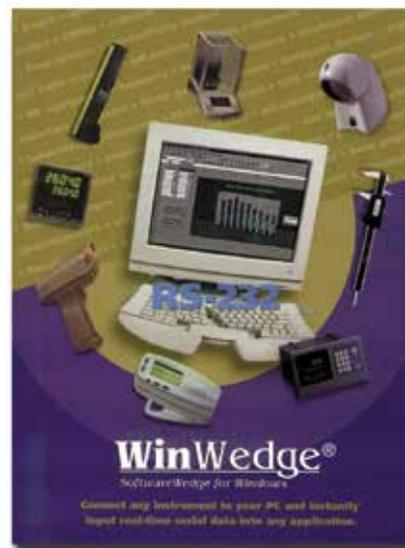

1. Select how you want the data collected:

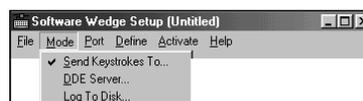

2. Choose the communication parameters for your serial device:

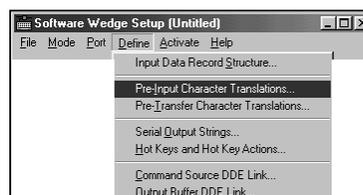

3. Define how you want the serial data to be parsed, filtered, and translated:

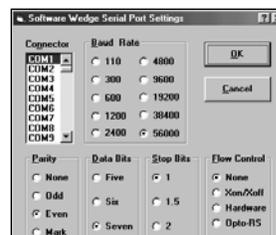

4. Activate WinWedge and watch your serial data "pop" into your application:

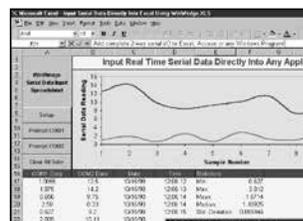



# Test Weights

## Table of Contents

<b>Weight and Calibration Specifications</b> .....	<b>818</b>	<b>Essential Weights</b> .....	<b>865</b>
<b>CAST IRON - NIST, ASTM and OIML</b> .....	<b>820</b>	<b>Metric Sets</b> .....	<b>866</b>
<b>Cast Iron</b> .....	<b>821</b>	Range: 500 mg	
Grip-handle and Nesting Slab Weights		Range: 500 mg	
Grip-handle Weights		Range: 20 g	
Slotted Interlocking and Hanger Weights		Range: 20 g	
Counterpoise and Hanger Weights		Range: 50 g	
<b>Avoirdupois</b> .....	<b>825</b>	Range: 50 g	
Counterpoise and Hanger Weights		Range: 100 g	
<b>STAINLESS STEEL - NIST</b> .....	<b>826</b>	Range: 100 g	
<b>Metric Individual Weights</b> .....	<b>827</b>	Range: 200 g	
<b>Avoirdupois Individual Weights</b> .....	<b>828</b>	Range: 200 g	
<b>Metric Sets</b> .....	<b>829</b>	Range: 300 g and 500 g	
Range: 5 and 50 g		Range: 300 g and 500 g	
Range: 100 g		Range: 1 kg	
Range: 500 g		Range: 1 kg	
Range: 1 kg		Range: 2 kg	
Range: 2 kg		Range: 2 kg	
Range: 5 kg		Range: 3 kg and 5 kg	
<b>Avoirdupois Set</b> .....	<b>835</b>	Range: 3 kg and 5 kg	
Range: 4 oz		Range: 10 kg	
Range: 1 lb		Range: 10 kg	
Range: 2 lb		Range: 20 kg and 25 kg	
Range: 5 lb		Range: 20 kg and 25 kg	
Range: 5 lb		<b>Avoirdupois Sets</b> .....	<b>888</b>
Range: 10 lb		Range: 50 lb through 2 lb	
Range: 10 lb		Range: 50 lb through 2 lb	
<b>SPECIALTY WEIGHTS - NIST</b> .....	<b>842</b>	<b>STAINLESS STEEL - OIML</b> .....	<b>890</b>
<b>Metric Cube and Ring Weights;</b>		<b>Metric Kits</b> .....	<b>891</b>
<b>Avoirdupois Ring Weights</b> .....	<b>843</b>	<b>Metric Kits and Weights</b> .....	<b>892</b>
<b>Avoirdupois Slotted Weights</b>		<b>Metric Sets</b> .....	<b>893</b>
<b>and Troy Cylindrical/Leaf Weights</b> .....	<b>844</b>	Range: 500 mg-50 g	
<b>Penny Cylindrical, Leaf, Grain</b>		Range: 100 g	
<b>and Lift Truck Weights</b> .....	<b>845</b>	Range: 200 g	
<b>Specialty Weights/Cube Weights Sets</b> .....	<b>846</b>	Range: 200 g	
<b>Avoirdupois and Metric Individual</b>		Range: 500 g	
<b>Hook Weights</b> .....	<b>847</b>	Range: 500 g	
<b>Avoirdupois and Metric Individual</b>		Range: 1 kg	
<b>Hangers and Slotted Weights</b> .....	<b>848</b>	Range: 1 kg	
<b>STAINLESS STEEL - ASTM</b> .....	<b>849</b>	Range: 2 kg	
<b>Metric Kits</b> .....	<b>850</b>	Range: 2 kg	
<b>Metric Individual Weights</b> .....	<b>851</b>	Range: 5 kg	
<b>Avoirdupois Kits</b> .....	<b>852</b>	Range: 5 kg	
<b>Avoirdupois Individual Weights</b> .....	<b>853</b>	Range: 10 kg	
<b>PRECISION LABORATORY - ASTM</b> .....	<b>854</b>	Range: 10 kg	
<b>Metric Kits</b> .....	<b>855</b>	Range: 20 kg	
<b>Metric Individual Weights</b> .....	<b>856</b>	Range: 20 kg	
<b>Avoirdupois Kits</b> .....	<b>861</b>	<b>Sealing Plugs</b> .....	<b>909</b>
<b>Avoirdupois Individual Weights</b> .....	<b>864</b>	<b>Gloves/Transfer Equipment</b> .....	<b>910</b>
		<b>Cases</b> .....	<b>911</b>
		<b>Transfer Cart/Touch-Up Paint/Canvas</b>	
		<b>Dust Covers</b> .....	<b>913</b>
		<b>Discontinued Products</b> .....	<b>914</b>

**ESPAÑOL** | Visit [ricelake.com/spanish](http://ricelake.com/spanish)  
to see all RLWS materials  
available in Spanish

Product names, logos, brands, and other trademarks featured or referred to within this publication are the property of their respective trademark holders.

## Weight and Calibration Specifications

Rice Lake Weighing Systems metrology staff has participated in basic, intermediate and advanced NIST/OWM training seminars, regional metrology groups such as MidMap, and round-robin metrology programs with state labs.

Rice Lake's calibration lab has direct traceability to NIST.

### Weights:

Rice Lake offers cast iron weights and three designs of stainless steel weights. Due to varying configurations, the actual appearance of your product may be slightly different than shown on the catalog page. Serial numbers are available for an additional charge. Individual leaf weights should be ordered with protective vial (individual leaf weights are for custom-designed kits)

### Weight Sets:

Rice Lake offers many configurations for their weight sets. Class F weights have many set configurations to assist in calibration of scales; higher accuracy sets are available in 5-2-2-1 and 5-3-2-1. A standard set would be as follows:

5-2-2-1 – (1) 50g, (2) 20g, and (1) 10g

5-3-2-1 – (1) 50g, (1) 30g, (1) 20g, and (1) 10g

Custom sets are available as build-to-order to meet your specific requirements.

Each weight set consists of the weights, case and/or small weight case (as appropriate), and appropriate lifting design consisting of one or more lifter, tweezer and white cotton gloves.

OIML and ASTM weights sets larger than 500g or 1 lb include a hardwood case with velvet-lined pockets. Cases are available to replace wooden cases if portability is required. Weight sets with the largest weight of 500g include a precision-machined polyvinyl, crush resistant case.

Serial numbers are not stamped on polished weights or milligram weights.

The correct class weight is dependent on the use. Weights should be more accurate than the precision of the weighing device and it is recommended that a weight has an accuracy of one-third (1/3) of the weighing device readability.

### Weights Kits:

All cylindrical ASTM kits (excluding grip handle weights) include their own protective case and glove set for safe handling.

### Calibration Certificates

Rice Lake offers several different calibration certificates including the Total Measure Assurance Program (TMAP) certification.

Calibration Certification for weight classes ASTM 0-3, OIML E1, E2, F1 and F2.

The calibration is performed per NIST Mass Dissemination. Meets ISO/IEC 17025 certification. For ASTM Class 0-3 and OIML E1, E2, F1 and F2 SOP 5, 3 in 1 weighing design and SOP 28 Advanced weighing designs.

Traceable Calibration Certificate meets requirements of ISO/IEC 17025 for ASTM 4-7, NIST F, OIML M1, M2, and M3. The calibration is performed per SOP 8 (following Rice Lake Work Instruction WI05-0023)

Rice Lake's Mass Value Certificate is not an accredited certificate, as found, as left data with environmental conditions reported. Uncertainty to Tolerance of 3:1 is not guaranteed for weight classes ASTM 1-3, OIML F1, and F2. SOP 8 (following Rice Lake Work Instruction WI05-0023). Additional time may be required for ASTM Class 0 weight certification.

Serial numbers are included in the cost of all certificates with the exception of the Statement of Accuracy. Certificates are included in the box with the weights at time of shipment. Replacement documentation is a fee of \$50 plus shipping.



# Weight and Calibration Specifications

## Weight and Calibration Specifications

### **Total Measurement Assurance Program (TMAP)**

TMAP has been part of the Rice Lake Metrology brand almost since its inception. TMAP covers all phases of our weight manufacturing and metrology groups to ensure that Metrology services meet all requirements.

### **Metrology Staff**

Metrology staff has participated in basic, intermediate and advanced NIST/OWM training seminars, regional metrology groups such as MidMap, and round-robin metrology programs with state labs.

### **Sales Staff**

Weights sales group receives continuous training to be of assistance in weight selection, configuration, tolerance recommendations and consultative.

### **Traceability**

Rice Lake's calibration lab has direct traceability to NIST.

### **Weight Design and Manufacturing**

Rice Lake offers cast iron weights and three (3) different designs of stainless steel weights.

Stainless Steel Weights are available as Electronic Balance, Grip-Handle, Precision (screw-knob design) or OIML Precision (One-piece design).

### **Calibration Services**

Calibration Certification for weight classes ASTM 0-3, OIML E1, E2, F1 and F2. The calibration is performed per NIST Mass Dissemination. Meets ISO/IEC 17025 certification.

Traceable Calibration Certificate weight classes ASTM 4-7, NIST F, OIML M1, M2, and M3.

## CAST IRON - NIST, ASTM and OIML

Painted weights with adjusting cavity for sealing

### Applications

- Field standards for testing industrial devices Class III, Class III L or III L L
- Testing for non-marked scales without Class designation
- Verifying scales are within specified accuracy and tolerances

### Styles Available:

- Grip-handle design for easy handling
- Nesting slab weights for heavy capacity
- Slotted weights and hangers for suspended weighing
- Counterpoise weights for ratio weighing

### Features:

- Nominal value marked on weight
- Weight capacities of 10kg/20lb and up meet NIST Handbook 105-1 and Handbook 44 specifications
- Metric weights designated by gold paint
- Avoirdupois (pound) weights designated by silver paint
- Serial numbers may be stamped on weights (option)

### Classes Available:

- NIST Class F
- ASTM Class 6 and 7
- OIML Class M1 and M2



# Cast Iron

## Grip-handle and Nesting Slab Weights

NIST CLASS F								OPTIONAL
Weight	Part #	Width	Length	Height	Slot Width	Slot Depth*	Price	Traceable Certificate
3,000 lb	<b>12872</b>	20 3/4in (527.1 mm)	20 3/4in (527.1 mm)	29in (736.6 mm)	3 1/2in (88.9 mm)	2 3/4in (69.9 mm)	\$8,700.00	\$300.00
2,500 lb	<b>12854</b>	20 3/4in (527.1 mm)	20 3/4in (527.1 mm)	24 3/4in (628.65 mm)	3 31/32in (100.8 mm)	2 3/4in (69.9 mm)	7,800.00	225.00
2,000 lb	<b>12868</b>	20 3/4in (527.05 mm)	20 3/4in (527.05 mm)	19 1/2in (495.3 mm)	3 1/2in (88.9 mm)	2 3/4in (69.9 mm)	6,900.00	225.00
1,500 lb	<b>12864</b>	15 1/8in (384.2 mm)	15 1/8in (384.2 mm)	26 7/8in (682.6 mm)	2 1/2in (63.5 mm)	2 1/4in (57.2 mm)	6,250.00	225.00
1,250 lb	<b>12858</b>	15in (381.0 mm)	15in (381.0 mm)	23 3/4in (603.3 mm)	2 1/2in (63.5 mm)	2 1/4in (57.2 mm)	5,220.00	225.00
1,000 lb	<b>12850</b>	15in (381.0 mm)	15 1/2in (393.7 mm)	18 11/16in (474.7 mm)	2 3/4in (69.9 mm)	2 29/32in (73.8 mm)	2,500.00	225.00
500 lb	<b>12844</b>	11 1/2in (292.1 mm)	12in (304.8 mm)	15 3/4in (400.1 mm)	2 1/2in (63.5 mm)	1 29/32in (48.4 mm)	1,570.00	225.00
250 lb	<b>12892</b>	9 3/4in (247.65 mm)	9 3/4in (247.65 mm)	12in (304.8 mm)	2 1/2in (63.5 mm)	2in (50.8 mm)	1,435.00	225.00
200 lb	<b>12890</b>	9 3/4in (247.65 mm)	9 3/4in (247.65 mm)	10in (254 mm)	2 1/2in (63.5 mm)	2in (50.8 mm)	1,250.00	225.00
100 lb	<b>12862</b>	9 1/8in (231.8 mm)	7in (177.8 mm)	7 7/8in (200.0 mm)	4 1/2in (114.3 mm)	1 1/2in (38.1 mm)	550.00	100.00
50 lb	<b>12839</b>	7 29/32in (200.8 mm)	5 1/2in (139.7 mm)	6 9/16in (166.7 mm)	4 1/2in (114.3 mm)	1 21/32in (42.1 mm)	130.00	75.00
30 lb	<b>12878</b>	8 1/4in (209.6 mm)	4 29/32in (124.6 mm)	4 1/2in (114.3 mm)	4 15/32in (113.5 mm)	31/32in (24.6 mm)	170.00	75.00
25 lb	<b>12833</b>	6 1/2in (165.1 mm)	4 1/2in (114.3 mm)	4 15/16in (125.4 mm)	3 5/8in (92.1 mm)	31/32in (24.6 mm)	115.00	75.00
20 lb	<b>12870</b>	5 3/4in (146.1 mm)	4 15/32in (113.5 mm)	5 3/32in (129.4 mm)	3 31/32in (100.8 mm)	1 5/32in (29.4 mm)	92.00	75.00

ASTM CLASS 7							OPTIONAL
Weight	Part #	Width	Length	Height	Price	Traceable Certificate	
10 lb	<b>12828</b>	5in (127.0 mm)	3 1/4in (82.6 mm)	4 1/32in (102.4 mm)	\$72.00	\$75.00	
5 lb	<b>12823</b>	4in (101.6 mm)	2 9/16in (65.1 mm)	3 7/32in (81.8 mm)	55.00	75.00	
2 lb	<b>12874</b>	3in (76.2 mm)	2 1/8in (54.0 mm)	1 3/4in (44.5 mm)	52.00	60.00	
1 lb	<b>12876</b>	2 1/2in (63.5 mm)	1 11/16in (42.9 mm)	1 13/32in (35.7 mm)	48.00	60.00	

NESTING SLAB NIST CLASS F								OPTIONAL
Weight	Part #	Width	Length	Height	Slot Width	Slot Depth*	Price	Traceable Certificate
2,500 lb	<b>12860</b>	42in (1066.8 mm)	30in (762 mm)	8 1/4in (209.5 mm)	2in (50.8 mm)	2 1/4in (57.15 mm)	\$7,800.00	\$225.00
1,000 lb	<b>34563</b>	29 1/2in (749.3 mm)	19 1/2in (495.3 mm)	7 1/4in (184.15 mm)	2in (50.8 mm)	2 1/4in (57.15 mm)	3,945.00	225.00

### ADDITIONAL ACCESSORIES

Part #	Description	Price
<b>36092</b>	Statement of Accuracy	\$45.00
<b>25836</b>	Serial number	15.00

\* Slot depth refers to distance between lifting bars and castings



Nesting Slab



Grip-handle

# Cast Iron

## Grip-handle Weights

TEST WEIGHTS

www.ricelake.com | Phone: 800-472-6703

RICELAKE

NIST CLASS F								OPTIONAL
Weight	Part #	Width	Length	Height	Slot Width	Slot Depth*	Price	Traceable Certificate
1,000kg	<b>12801</b>	20 1/2 in (520.7 mm)	20 1/2 in (520.7 mm)	22 in (558.8 mm)	3 1/2 in (88.9 mm)	2 3/4 in (69.85 mm)	\$6,900.00	\$300.00
500 kg	<b>12797</b>	15 1/8 in (384.2 mm)	15 1/8 in (384.2 mm)	20 3/4 in (527 mm)	2 1/2 in (63.5 mm)	2 in (50.8 mm)	2,550.00	225.00
250 kg	<b>12782</b>	11 1/2 in (292.1 mm)	12 1/2 in (317.5 mm)	17 1/2 in (444.5 mm)	2 1/2 in (63.5 mm)	1 7/8 in (47.6 mm)	1,600.00	225.00
200 kg	<b>12793</b>	11 1/2 in (292.1 mm)	12 in (304.8 mm)	14 1/4 in (362 mm)	2 1/2 in (63.5 mm)	1 7/8 in (47.6 mm)	1,375.00	225.00
100 kg	<b>12817</b>	9 7/8 in (250.8 mm)	9 7/8 in (250.8 mm)	11 in (279.4 mm)	2 1/2 in (63.5 mm)	2 in (50.8 mm)	1,265.00	225.00
50 kg	<b>12803</b>	9 7/32 in (234.2 mm)	7 in (177.8 mm)	8 13/16 in (223.8 mm)	4 15/32 in (113.5 mm)	1 29/32 in (48.4 mm)	550.00	125.00
35 kg	<b>12805</b>	7 7/8 in (200.0 mm)	5 1/2 in (139.7 mm)	9 15/32 in (252.4 mm)	4 15/32 in (113.5 mm)	1 1/16 in (27.0 mm)	390.00	125.00
25 kg	<b>12775</b>	7 21/32 in (194.5 mm)	5 1/2 in (139.7 mm)	7 3/32 in (180.2 mm)	4 7/16 in (112.7 mm)	1 13/16 in (46.0 mm)	150.00	70.00
20 kg	<b>12771</b>	7 5/8 in (193.7 mm)	5 19/32 in (142.1 mm)	5 29/32 in (150.0 mm)	4 5/8 in (117.5 mm)	1 19/32 in (40.5 mm)	125.00	70.00
10 kg	<b>12767</b>	6 in (152.4 mm)	4 1/2 in (114.3 mm)	5 in (127.0 mm)	3 3/4 in (95.3 mm)	1 1/16 in (27.0 mm)	120.00	70.00

ASTM CLASS 7						OPTIONAL
Weight	Part #	Width	Length	Height	Price	Traceable Certificate
5 kg	<b>12786</b>	5 15/32 in (138.9 mm)	3 13/32 in (86.5 mm)	4 1/8 in (104.8 mm)	\$72.00	\$70.00
2 kg	<b>12809</b>	3 31/32 in (100.8 mm)	2 9/16 in (65.1 mm)	2 13/16 in (71.4 mm)	60.00	70.00
1 kg	<b>12813</b>	3 in (76.2 mm)	2 1/8 in (54.0 mm)	1 27/32 in (46.8 mm)	52.00	70.00
500 g	<b>12815</b>	2 1/2 in (63.5 mm)	1 5/8 in (41.3 mm)	1 17/32 in (38.9 mm)	48.00	70.00

OIML CLASS M1								OPTIONAL
Weight	Part #	Width	Length	Height	Slot Width	Slot Depth*	Price	Traceable Certificate
500 kg	<b>156304</b>	15 1/8 in (384.2 mm)	15 1/8 in (384.2 mm)	20 3/4 in (527 mm)	2 1/2 in (63.5 mm)	2 in (50.8 mm)	\$2,800.00	\$225.00
250 kg	<b>156305</b>	15 1/8 in (384.2 mm)	15 1/8 in (384.2 mm)	20 3/4 in (527 mm)	2 1/2 in (63.5 mm)	1 7/8 in (47.6 mm)	1,600.00	225.00
100 kg	<b>156306</b>	15 1/8 in (384.2 mm)	15 1/8 in (384.2 mm)	20 3/4 in (527 mm)	2 1/2 in (63.5 mm)	2 in (50.8 mm)	1,300.00	225.00
50 kg	<b>105417</b>	9 7/32 in (234.2 mm)	7 in (177.8 mm)	8 13/16 in (223.8 mm)	4 15/32 in (113.5 mm)	1 29/32 in (48.4 mm)	585.00	125.00
20 kg	<b>105416</b>	7 5/8 in (193.7 mm)	5 19/32 in (142.1 mm)	5 29/32 in (150.0 mm)	4 5/8 in (117.5 mm)	1 19/32 in (40.5 mm)	155.00	70.00
10 kg	<b>105415</b>	6 in (152.4 mm)	4 1/2 in (114.3 mm)	5 in (127.0 mm)	3 3/4 in (95.3 mm)	1 1/16 in (27.0 mm)	120.00	70.00
5 kg	<b>105414</b>	5 15/32 in (138.9 mm)	3 13/32 in (86.5 mm)	4 1/8 in (104.8 mm)	-	-	90.00	70.00

### ADDITIONAL ACCESSORIES

Part #	Description	Price
<b>36092</b>	Statement of Accuracy	\$45.00
<b>25836</b>	Serial number	15.00

\* Slot depth refers to distance between lifting bars and castings



Grip-handle

# Cast Iron

## Slotted Interlocking and Hanger Weights

### SLOTTED ASTM CLASS 6

OPTIONAL

Weight	Part #	Slot Width	Diameter	Height	Price	Traceable Certificate
100 lb	<b>40828</b>	1 in (25.4 mm)	17 in (431.8 mm)	1 15/16 in (49.2 mm)	\$565.00	\$100.00
50 lb	<b>12856</b>	3/4 in (9 mm)	10 5/8 in (269.9 mm)	2 11/16 in (68.3 mm)	195.00	75.00
20 lb	<b>12831</b>	13/16 in (20.6 mm)	8 1/8 in (206.4 mm)	1 31/32 in (50.0 mm)	95.00	75.00

### SLOTTED ASTM CLASS 7

OPTIONAL

Weight	Part #	Slot Width	Diameter	Height	Price	Traceable Certificate
10 lb	<b>12826</b>	13/16 in (20.6 mm)	6 1/8 in (155.6 mm)	1 11/16 in (42.9 mm)	\$80.00	\$75.00
5 lb	<b>12852</b>	11/16 in (17.5 mm)	5 1/8 in (130.2 mm)	1 5/16 in (33.3 mm)	65.00	75.00
2 lb	<b>12848</b>	9/16 in (14.3 mm)	5 in (127.0 mm)	23/32 in (18.3 mm)	55.00	60.00
1 lb	<b>12842</b>	9/16 in (14.3 mm)	5 in (127.0 mm)	15/32 in (11.9 mm)	55.00	60.00
1/2 lb	<b>12837</b>	9/16 in (14.3 mm)	3 3/4 in (95.3 mm)	7/16 in (11.1 mm)	44.00	35.00

### HANGER ASTM CLASS 7

OPTIONAL

Weight	Capacity	Part #	Total Length	Operational Length	Diameter	Price	Traceable Certificate
5 lb*	500 lb	<b>12846</b>	37 1/4 in (946.2 mm)	35 in (889.0 mm)	4 in (101.6 mm)	\$260.00	\$75.00
2 lb	200 lb	<b>12841</b>	21 13/32 in (543.7 mm)	19 in (482.6 mm)	3 3/4 in (95.3 mm)	130.00	60.00
2 lb	200 lb	<b>12835</b>	10 1/4 in (260.4 mm)	8 in (203.2 mm)	3 3/4 in (95.3 mm)	124.00	60.00
1 lb	200 lb	<b>12830</b>	21 29/32 in (556.4 mm)	20 7/32 in (513.6 mm)	3 3/4 in (95.3 mm)	110.00	60.00
1 lb	200 lb	<b>12825</b>	9 5/16 in (236.5 mm)	7 9/16 in (192.1 mm)	3 3/4 in (95.3 mm)	90.00	60.00

\* Stainless

### SLOTTED ASTM CLASS 6

OPTIONAL

Weight	Part #	Slot Width	Diameter	Height	Price	Traceable Certificate
20 kg	<b>12819</b>	21/32 in (16.7 mm)	10 5/16 in (261.9 mm)	2 11/32 in (59.5 mm)	\$220.00	\$70.00
10 kg	<b>12811</b>	3/4 in (19.1 mm)	8 3/16 in (208.0 mm)	2 1/16 in (52.4 mm)	122.00	70.00

### SLOTTED ASTM CLASS 7

OPTIONAL

Weight	Part #	Slot Width	Diameter	Height	Price	Traceable Certificate
5 kg	<b>12807</b>	13/16 in (20.6 mm)	6 3/16 in (157.2 mm)	1 13/16 in (46.0 mm)	\$90.00	\$70.00
2 kg	<b>12799</b>	9/16 in (14.3 mm)	5 1/8 in (130.2 mm)	1 3/16 in (30.2 mm)	65.00	70.00
1 kg	<b>12795</b>	9/16 in (14.3 mm)	5 1/16 in (128.6 mm)	3/4 in (19.1 mm)	57.00	50.00
500 g	<b>12791</b>	9/16 in (14.3 mm)	5 in (127.0 mm)	15/32 in (11.9 mm)	55.00	50.00
200 g	<b>12780</b>	5/8 in (15.9 mm)	3 21/32 in (92.9 mm)	7/16 in (11.1 mm)	45.00	50.00

### HANGER ASTM CLASS 7

OPTIONAL

Weight	Capacity	Part #	Total Length	Operational Length	Diameter	Price	Traceable Certificate
2 kg	250 kg	<b>12788</b>	37 1/4 in (946.2 mm)	35 in (889.0 mm)	4 in (101.6 mm)	\$260.00	\$70.00
1 kg	100 kg	<b>12784</b>	21 13/32 in (543.7 mm)	19 in (482.6 mm)	3 3/4 in (95.3 mm)	125.00	50.00
1 kg	100 kg	<b>12777</b>	10 1/4 in (260.4 mm)	8 in (203.2 mm)	3 3/4 in (95.3 mm)	124.00	50.00
500 g	100 kg	<b>12773</b>	21 29/32 in (556.4 mm)	20 7/32 in (513.6 mm)	3 3/4 in (95.3 mm)	110.00	50.00
500 g	100 kg	<b>12769</b>	9 5/16 in (236.5 mm)	7 9/16 in (192.1 mm)	3 3/4 in (95.3 mm)	100.00	50.00

### ADDITIONAL ACCESSORIES

Part #	Description	Price
<b>36092</b>	Statement of Accuracy	\$45.00
<b>25836</b>	Serial number	15.00



# Cast Iron

Counterpoise and Hanger Weights

## ROUND ASTM CLASS 7

Ratio	Weight	Part #	Diameter	Fairbanks Part #	Price
1 lb - 100lb	50lb x 1/2lb	<b>10154</b>	2 7/8in (73.0mm)	PA48	\$35.00
1 lb - 100lb	100lb x 1 lb	<b>10156</b>	4 1/16in (103.2mm)	PA32	40.00
1 lb - 100lb	200lb x 2lb	<b>10158</b>	4 1/16in (103.2mm)	PA21	35.00
1 lb - 100lb	500lb x 5lb	<b>10160</b>	3 3/4in (95.3mm)	PB52	40.00
1/2lb - 100lb	100lb x 1/2lb	<b>10152</b>	2 7/8in (73.0mm)	PBC32	35.00
1/2lb - 100lb	200lb x 1 lb	<b>10168</b>	3 17/32in (89.7mm)	PBC21	45.00
1/2lb - 100lb	300lb x 1 1/2lb	<b>10189</b>	3 1/2in (88.9mm)	-	35.00
1/2lb - 100lb	500lb x 2 1/2lb	<b>10170</b>	3 1/2in (88.9mm)	PBC52	50.00
1/2lb - 100lb	1000lb x 5 lb	<b>10196</b>	3 7/8in (98.4mm)	-	60.00

## HANGERS - ROUND AND SQUARE ASTM CLASS 7

Approx. Weight	Part #	Total Length	Operational Length	Diameter	Price
<b>Round</b>					
7 oz	<b>10188</b>	7 1/16in (179.4mm)	5 1/8in (130.2mm)	3 31/32in (100.8mm)	\$65.00
10 oz (Fairbanks only)	<b>10184</b>	7 1/16in (179.4mm)	5 1/8in (130.2mm)	3 31/32in (100.8mm)	65.00
12 oz	<b>10185</b>	7 1/16in (179.4mm)	5 1/8in (130.2mm)	3 31/32in (100.8mm)	65.00
17 oz	<b>10186</b>	7 1/16in (179.4mm)	5 1/8in (130.2mm)	4in (101.6mm)	65.00
21 oz	<b>10187</b>	7 1/16in (179.4mm)	5 1/8in (130.2mm)	4in (101.6mm)	65.00
<b>Square</b>					
21 oz	<b>10193</b>	8 7/16in (214.3mm)	6 5/16in (160.3mm)	-	65.00

## HEXAGON ASTM CLASS 7

Weight	Part #	Diameter	Price
10kg x 100g	<b>10266</b>	2in (50.8mm)	\$40.00
25kg x 250g	<b>10268</b>	2 13/16in (71.4mm)	40.00
50kg x 500g	<b>10270</b>	4in (101.6mm)	44.00
100kg x 1kg	<b>10272</b>	4in (101.6mm)	47.00
200kg x 2kg	<b>10274</b>	4in (101.6mm)	52.00

## SQUARE ASTM CLASS 7

Ratio	Weight	Part #	Diameter	Fairbanks Part #	Price
1 lb - 100lb	50lb x 1/2lb	<b>10191</b>	2 5/16in (58.7mm)	1A2349	\$40.00
1 lb - 100lb	100lb x 1 lb	<b>10162</b>	3 1/2in (88.9mm)	1A1469	40.00
1 lb - 100lb	200lb x 2lb	<b>10164</b>	3 1/2in (88.9mm)	1A1470	45.00
1 lb - 100lb	500lb x 5lb	<b>10166</b>	3 1/2in (88.9mm)	1A1471	75.00



Fairbanks Round Individual and Hanger



Fairbanks Square Individual and Hanger



Cast Iron - NIST, ASTM and OIML  
**Avoirdupois**  
 Counterpoise and Hanger Weights

**ROUND ASTM CLASS 7**

Ratio	Weight	Part #	Diameter	Howe Part #	Price
-	50lb x 1/2lb	<b>10367</b>	3in (76.2mm)	42071831	\$45.00
-	100lb x 1lb	<b>10369</b>	2 7/8in (73.0mm)	42076188	45.00
-	200lb x 2lb	<b>10371</b>	2 31/32in (75.4mm)	42076189	45.00
-	300lb x 3lb	<b>10373</b>	2 31/32in (75.4mm)	42076190	45.00
-	500lb x 5lb	<b>10385</b>	3 1/8in (79.4mm)	42078947	45.00
For Counting Scales					
99 - 1	100lb x 1 1/99lb	<b>10387</b>	3in (76.2mm)	40810545	50.00
99 - 1	200lb x 2 2/99lb	<b>10389</b>	2 7/8in (73.0mm)	40810546	50.00
99 - 1	500lb x 5 5/99lb	<b>10391</b>	3 3/32in (78.6mm)	42111567	50.00
8 - 1	10lb x 1 1/4lb	<b>10427</b>	2 15/16in (74.6mm)	-	50.00
8 - 1	5lb x 5/8lb	<b>10425</b>	2 15/16in (74.6mm)	-	50.00
8 - 1	2lb x 1/4lb	<b>10411</b>	2 7/32in (56.4mm)	-	45.00
50 - 1	80lb x 1 3/5lb	<b>10421</b>	3in (76.2mm)	-	45.00
50 - 1	40lb x 4/5lb	<b>10419</b>	2 13/16in (71.4mm)	-	45.00
50 - 1	20lb x 2/5lb	<b>10417</b>	2 31/32in (75.4mm)	-	50.00
50 - 1	10lb x 1/5lb	<b>10415</b>	2in (50.8mm)	-	45.00
50 - 1	5lb x 1/10lb	<b>10413</b>	1 1/2in (38.1mm)	-	45.00
64 - 1	100lb x 1 9/16lb or 25oz	<b>10409</b>	3in (76.2mm)	42111417	45.00
61 - 1	50lb x 28/32lb or 12 1/2oz	<b>10407</b>	2 15/16in (74.6mm)	40807082	45.00
64 - 1	25lb x 25/64lb or 6 1/4oz	<b>10405</b>	2 31/32in (75.4mm)	40807092	45.00
64 - 1	10lb x 5/32lb or 2 1/2oz	<b>10404</b>	1 1/2in (38.1mm)	42111454	45.00

**ROUND HANGER ASTM CLASS 7**

Approx. Weight	Part #	Total Length	Operational Length	Diameter	Price
7oz	<b>10382</b>	8 1/4in (209.6mm)	6 3/16in (157.2mm)	2 31/32in (75.4)	\$60.00
10oz	<b>10379</b>	8 1/4in (209.6mm)	6 3/16in (157.2mm)	2 31/32in (75.4)	60.00
12oz	<b>10380</b>	8 1/4in (209.6mm)	6 3/16in (157.2mm)	2 31/32in (75.4)	100.00
16oz	<b>10381</b>	8 1/4in (209.6mm)	6 3/16in (157.2mm)	2 31/32in (75.4)	100.00

**TRIANGLE ASTM CLASS 7**

Approx. Weight	Part #	Toledo Part #	Price
100lb x 1lb	<b>11417</b>	49868	\$35.00
200lb x 2lb	<b>11419</b>	49869	40.00
500lb x 5lb	<b>11421</b>	49870	60.00

**TRIANGLE HANGER ASTM CLASS 7**

Approx. Weight	Part #	Total Length	Operational Length	Toledo Part #	Price
14oz	<b>11423</b>	8 1/4in (209.6mm)	6 3/16in (157.2mm)	49857	\$60.00



## STAINLESS STEEL - NIST

### Applications:

- Field standards for Class III scales or balances
- Testing non-classified scale equipment
- Tolerance checking

### Styles Available:

- Cylindrical
- Grip-handle
- Dish weights

### Product Configuration:

- Individual weight
- Weight sets

### Weight Set Configuration:

- Weights (typical configuration is 5-2-2-1 or 5-3-2-1)  
Example: 50, (2) 20 or 10 or 50, 30, 20, 10
- Glove
- Lifting device or tweezer if applicable

### Features:

- Stainless steel weights designed to meet NIST Handbook 44 and 105-1
- Class F tolerances
- Sealing cavity for adjustment for most weights
- Serial numbers may be stamped on weights (option)
- Nominal value marked on weights





# Stainless Steel - NIST Metric Individual Weights

## GRIP-HANDLE CLASS F

Weight	Part #	Height	Diameter	Price	OPTIONAL Traceable Certificate
30kg	<b>12572</b>	9 3/16 in (233.3 mm)	6 in (152.4 mm)	\$1,055.00	\$75.00
25kg	<b>12571</b>	7 3/16 in (182.5 mm)	6 in (152.4 mm)	835.00	70.00
20kg	<b>12569</b>	6 7/16 in (163.5 mm)	6 in (152.4 mm)	720.00	70.00
10kg	<b>12567</b>	5 3/16 in (131.7 mm)	5 in (127.0 mm)	510.00	70.00
8kg	<b>12565</b>	4 13/32 in (111.9 mm)	5 in (127.0 mm)	475.00	70.00
5kg	<b>12564</b>	3 7/32 in (81.8 mm)	5 in (127.0 mm)	275.00	70.00

## CYLINDRICAL CLASS F

Weight	Part #	Height	Diameter	Price	OPTIONAL Traceable Certificate	OPTIONAL CASES Part #	Price
5kg	<b>12521</b>	4 13/32 in (111.9 mm)	3 1/2 in (88.9 mm)	\$200.00	\$70.00	<b>11462</b>	\$42.00
4kg	<b>12519</b>	3 3/16 in (96.7 mm)	3 3/8 in (85.0 mm)	185.00	70.00	<b>11463</b>	42.00
3kg	<b>12517</b>	3 23/32 in (94.5 mm)	3 in (76.2 mm)	165.00	70.00	<b>11464</b>	42.00
2kg	<b>12515</b>	3 5/16 in (83.7 mm)	2 5/8 in (66.2 mm)	120.00	70.00	<b>11465</b>	42.00
1kg	<b>12513</b>	2 11/16 in (68.2 mm)	2 in (50.4 mm)	70.00	50.00	<b>11468</b>	42.00
500g	<b>12511</b>	2 1/8 in (53.8 mm)	1 5/8 in (40.9 mm)	65.00	50.00	<b>11470</b>	42.00
400g	<b>12531</b>	2 1/32 in (51.6 mm)	1 1/2 in (38.1 mm)	60.00	50.00	<b>11471</b>	42.00
300g	<b>12529</b>	1 13/16 in (45.9 mm)	1 3/8 in (34.5 mm)	60.00	50.00	<b>11472</b>	42.00
200g	<b>12509</b>	1 21/32 in (42.1 mm)	1 3/16 in (30.2 mm)	50.00	50.00	<b>11473</b>	42.00
150g	<b>12549</b>	1 9/32 in (32.5 mm)	1 3/16 in (30.2 mm)	45.00	50.00	<b>11475</b>	42.00
100g	<b>12507</b>	1 3/16 in (30.2 mm)	1 in (25.4 mm)	42.00	35.00	<b>11476</b>	42.00
50g	<b>12527</b>	31/32 in (24.6 mm)	3/4 in (19.1 mm)	38.00	35.00	<b>11480</b>	42.00
30g	<b>12525</b>	11/16 in (16.7 mm)	11/16 in (17.4 mm)	35.00	35.00	<b>11481</b>	42.00
20g	<b>12523</b>	5/8 in (15.9 mm)	19/32 in (15.1 mm)	35.00	35.00	<b>11482</b>	42.00
10g	<b>12505</b>	19/32 in (15.1 mm)	7/16 in (11.1 mm)	35.00	35.00	<b>11483</b>	42.00
5g	<b>12503</b>	13/32 in (10.3 mm)	3/8 in (9.5 mm)	30.00	35.00	-	-
3g	<b>12533</b>	3/8 in (9.3 mm)	5/16 in (7.5 mm)	30.00	35.00	-	-
2g	<b>12501</b>	5/16 in (7.9 mm)	9/32 in (7.1 mm)	30.00	35.00	-	-
1g	<b>12499</b>	1/4 in (6.4 mm)	7/32 in (5.6 mm)	30.00	35.00	-	-

## MILLIGRAM CLASS F

Weight	Part #	Price	OPTIONAL Traceable Certificate
500mg	<b>12913</b>	\$18.00	\$35.00
300mg	<b>12914</b>	18.00	35.00
200mg	<b>12915</b>	18.00	35.00
100mg	<b>12916</b>	18.00	35.00
50mg	<b>12917</b>	18.00	35.00
30mg	<b>12918</b>	18.00	35.00
20mg	<b>12919</b>	18.00	35.00
10mg	<b>12920</b>	18.00	35.00
5mg	<b>12921</b>	18.00	35.00
3mg	<b>12922</b>	18.00	35.00
2mg	<b>12923</b>	18.00	35.00
1mg	<b>12924</b>	18.00	35.00

## ADDITIONAL ACCESSORIES

Part #	Description	Price
<b>36092</b>	Statement of Accuracy	\$45.00
<b>25836</b>	Serial number	15.00



Grip-handle



Cylindrical



Leaf

TEST WEIGHTS

www.ricelake.com | Phone: 800-472-6703

RICE LAKE

# Avoirdupois Individual Weights

TEST WEIGHTS

www.ricelake.com | Phone: 800-472-6703

RICELAKE

828

## GRIP-HANDLE CLASS F

Weight	Part#	Height	Diameter	Price	Traceable Certificate
50lb	<b>12677</b>	6 21/32 in (169.1 mm)	6 in (127.0mm)	\$785.00	\$75.00
30lb	<b>12676</b>	6 11/16 in (169.0mm)	5 in (126.4 mm)	595.00	75.00
25lb	<b>12675</b>	5 3/4 in (145.9mm)	5 in (126.4 mm)	500.00	75.00
20lb	<b>12674</b>	4 27/32 in (123.0mm)	5 in (127.0mm)	460.00	75.00
10lb	<b>12673</b>	3 1/32 in (77.0mm)	5 in (127.0mm)	275.00	75.00

## OPTIONAL

## CYLINDRICAL CLASS F

Weight	Part #	Height	Diameter	Price	Traceable Certificate	Part #	Price
10lb	<b>12606</b>	4 1/16 in (103.0mm)	3 1/2 in (88.1 mm)	\$190.00	\$75.00	<b>152299</b>	\$42.00
5 lb	<b>12604</b>	3 11/16 in (93.2mm)	2 5/8 in (66.2mm)	120.00	75.00	<b>11496</b>	42.00
4 lb	<b>12602</b>	3 1/16 in (77.0 mm)	2 5/8 in (66.2 mm)	115.00	75.00	<b>11465</b>	42.00
3 lb	<b>12600</b>	2 15/16 in (74.4 mm)	2 1/4 in (56.8 mm)	110.00	75.00	<b>11495</b>	42.00
2 lb	<b>12598</b>	2 15/32 in (62.7 mm)	2 in (50.8 mm)	65.00	60.00	<b>11468</b>	42.00
1 lb	<b>12596</b>	2 9/32 in (57.9 mm)	1 1/2 in (38.1 mm)	55.00	60.00	<b>82983</b>	42.00
12 oz	<b>12626</b>	2 1/16 in (51.6 mm)	1 3/8 in (34.5 mm)	50.00	35.00	-	-
8 oz	<b>12594</b>	1 21/32 in (42.1 mm)	1 1/4 in (31.8 mm)	45.00	35.00	<b>11491</b>	42.00
4 oz	<b>12592</b>	1 11/32 in (34.1 mm)	1 in (25.4 mm)	40.00	35.00	<b>11494</b>	42.00
2 oz	<b>12590</b>	15/16 in (23.8 mm)	13/16 in (20.6 mm)	38.00	35.00	<b>11479</b>	42.00
1 oz	<b>12587</b>	13/16 in (20.2 mm)	5/8 in (15.5 mm)	35.00	35.00	<b>11493</b>	42.00
1/2 oz	<b>12584</b>	21/32 in (16.7 mm)	1/2 in (12.7 mm)	35.00	35.00	<b>11492</b>	42.00
1/4 oz	<b>12581</b>	5/8 in (15.9 mm)	3/8 in (9.6 mm)	30.00	35.00	-	-
1/8 oz	<b>12578</b>	7/16 in (10.8 mm)	5/16 in (7.5 mm)	30.00	35.00	-	-
1/16 oz	<b>12575</b>	3/8 in (9.6 mm)	1/4 in (6.4 mm)	30.00	35.00	-	-
1/32 oz	<b>12608</b>	11/32 in (8.7 mm)	3/16 in (4.8 mm)	30.00	35.00	-	-
0.5 oz	<b>12647</b>	21/32 in (16.7 mm)	1/2 in (12.7 mm)	35.00	35.00	-	-
0.3 oz	<b>12645</b>	17/32 in (13.5 mm)	7/16 in (11.1 mm)	35.00	35.00	-	-
0.2 oz	<b>12643</b>	1/2 in (12.8 mm)	3/8 in (9.1 mm)	35.00	35.00	-	-
0.1 oz	<b>12641</b>	3/8 in (9.0 mm)	5/16 in (7.5 mm)	35.00	35.00	-	-
0.05 oz	<b>12639</b>	5/16 in (7.4 mm)	1/4 in (6.0 mm)	35.00	35.00	-	-
0.5 lb	<b>12624</b>	1 21/32 in (42.1 mm)	1 1/4 in (31.8 mm)	45.00	35.00	-	-
0.3 lb	<b>12622</b>	1 3/16 in (30.2 mm)	1 1/8 in (28.2 mm)	45.00	35.00	-	-
0.2 lb	<b>12610</b>	1 7/32 in (31.0 mm)	15/16 in (23.8 mm)	38.00	35.00	-	-
0.1 lb	<b>12612</b>	7/8 in (21.8 mm)	3/4 in (18.7 mm)	38.00	35.00	-	-
0.05 lb	<b>12614</b>	23/32 in (18.3 mm)	19/32 in (15.1 mm)	38.00	35.00	-	-
0.03 lb	<b>12620</b>	5/8 in (15.7 mm)	1/2 in (12.3 mm)	38.00	35.00	-	-
0.02 lb	<b>12616</b>	9/16 in (13.7 mm)	7/16 in (10.7 mm)	38.00	35.00	-	-
0.01 lb	<b>12618</b>	17/32 in (13.5 mm)	5/16 in (7.9 mm)	38.00	35.00	-	-

## OPTIONAL

## OPTIONAL CASES

## DISH WEIGHTS

## OPTIONAL

Weight	Part #	Price	Traceable Certificate
0.005 lb	<b>12909</b>	\$35.00	\$35.00
0.003 lb	<b>12912</b>	35.00	35.00
0.002 lb	<b>12910</b>	35.00	35.00
0.001 lb	<b>12911</b>	35.00	35.00



Dish Weights  
0.005 lb - 0.001 lb



Grip-handle



Cylindrical



Stainless Steel - NIST

# Metric Sets

Range: 100g

TEST WEIGHTS

## CLASS F

CLASS F			OPTIONAL	REPLACEMENT CASES	
Set Size	Part #	Price	Traceable Certificate	Part #	Price
100g - 1 mg	<b>12510</b>	\$215.00	\$485.00	<b>11512</b>	\$30.00
100g - 10mg	<b>12508</b>	205.00	380.00	<b>11512</b>	30.00
100g - 1 g	<b>12506</b>	185.00	205.00	<b>11512</b>	30.00

## WEIGHT SET CONTENTS

100g - 1 mg	100g - 10mg	100g - 1 g
1 - 100g	1 - 100g	1 - 100g
1 - 50g	1 - 50g	1 - 50g
2 - 20g	2 - 20g	2 - 20g
1 - 10g	1 - 10g	1 - 10g
1 - 5g	1 - 5g	1 - 5g
2 - 2g	2 - 2g	2 - 2g
1 - 1g	1 - 1g	1 - 1g
1 - 500mg	1 - 500mg	
2 - 200mg	2 - 200mg	
1 - 100mg	1 - 100mg	
1 - 50mg	1 - 50mg	
2 - 20mg	2 - 20mg	
1 - 10mg	1 - 10mg	
1 - 5mg		
2 - 2mg		
1 - 1mg		
<b>Piece Count</b>		
21	17	9
<b>Total Weight</b>		
211.11g	211.19g	210.000g
<b>Part #</b>		
<b>12510</b>	<b>12508</b>	<b>12506</b>

## CASE INSERT

Size	Part #	Price
100g - 1 mg	<b>11519</b>	\$30.00
100g - 10mg	<b>11519</b>	30.00
100g - 1 g	<b>11518</b>	30.00

## ADDITIONAL ACCESSORIES

Part #	Description	Price
<b>36092</b>	Statement of Accuracy	\$45.00
<b>11758</b>	Leaf weight cover	35.00
<b>65640</b>	Tweezer	15.00
<b>25836</b>	Serial number	15.00
<b>152414</b>	Premium tweezer	35.00



www.ricelake.com | Phone: 800-472-6703

RICELAKE

Stainless Steel - NIST

# Metric Sets

Range: 500g

CLASS F			OPTIONAL	REPLACEMENT CASES	
Set Size	Part #	Price	Traceable Certificate	Part #	Price
500g - 1mg	<b>12516</b>	\$395.00	\$575.00	<b>11520</b>	\$60.00
500g - 10mg	<b>12514</b>	355.00	485.00	<b>11520</b>	60.00
500g - 1g	<b>12512</b>	315.00	300.00	<b>11520</b>	60.00

## WEIGHT SET CONTENTS

500g - 1mg	500g - 10mg	500g - 1g
1 - 500g	1 - 500g	1 - 500g
2 - 200g	2 - 200g	2 - 200g
1 - 100g	1 - 100g	1 - 100g
1 - 50g	1 - 50g	1 - 50g
2 - 20g	2 - 20g	2 - 20g
1 - 10g	1 - 10g	1 - 10g
1 - 5g	1 - 5g	1 - 5g
2 - 2g	2 - 2g	2 - 2g
1 - 1g	1 - 1g	1 - 1g
1 - 500mg	1 - 500mg	
2 - 200mg	2 - 200mg	
1 - 100mg	1 - 100mg	
1 - 50mg	1 - 50mg	
2 - 20mg	2 - 20mg	
1 - 10mg	1 - 10mg	
1 - 5mg		
2 - 2mg		
1 - 1mg		
<b>Piece Count</b>		
24	20	12
<b>Total Weight</b>		
1.11111 kg	1.1111 kg	1.110 kg
<b>Part #</b>	<b>Part #</b>	<b>Part #</b>
<b>12516</b>	<b>12514</b>	<b>12512</b>

## SECONDARY CASE

Size	Part #	Price
100g - 1mg	<b>11512</b>	\$30.00
100g - 10mg	<b>11512</b>	30.00
100g - 1g	<b>11512</b>	30.00

## CASE INSERT

Size	Part #	Price
100g - 1mg	<b>11519</b>	\$30.00
100g - 10mg	<b>11519</b>	30.00
100g - 1g	<b>11518</b>	30.00

## ADDITIONAL ACCESSORIES

Part #	Description	Price
<b>36092</b>	Statement of Accuracy	\$45.00
<b>11758</b>	Leaf weight cover	35.00
<b>65640</b>	Tweezer	15.00
<b>25836</b>	Serial number	15.00
<b>152414</b>	Premium tweezer	35.00



TEST WEIGHTS

www.ricelake.com | Phone: 800-472-6703

**RICE LAKE**

Stainless Steel - NIST

# Metric Sets

Range: 1 kg

TEST WEIGHTS

www.ricelake.com | Phone: 800-472-6703

RICELAKE

## CLASS F

Set Size	Part #	Price
1 kg - 1 mg	<b>12522</b>	\$440.00
1 kg - 10 mg	<b>12520</b>	435.00
1 kg - 1 g	<b>12518</b>	405.00

## OPTIONAL

Traceable Certificate
\$600.00
520.00
335.00

## REPLACEMENT CASES

Part #	Price
<b>11521</b>	\$60.00
<b>11521</b>	60.00
<b>11521</b>	60.00

## WEIGHT SET CONTENTS

1 kg - 1 mg	1 kg - 10 mg	1 kg - 1 g
1 - 1 kg	1 - 1 kg	1 - 1 kg
1 - 500g	1 - 500g	1 - 500g
2 - 200g	2 - 200g	2 - 200g
1 - 100g	1 - 100g	1 - 100g
1 - 50g	1 - 50g	1 - 50g
2 - 20g	2 - 20g	2 - 20g
1 - 10g	1 - 10g	1 - 10g
1 - 5g	1 - 5g	1 - 5g
2 - 2g	2 - 2g	2 - 2g
1 - 1g	1 - 1g	1 - 1g
1 - 500mg	1 - 500mg	
2 - 200mg	2 - 200mg	
1 - 100mg	1 - 100mg	
1 - 50mg	1 - 50mg	
2 - 20mg	2 - 20mg	
1 - 10mg	1 - 10mg	
1 - 5mg		
2 - 2mg		
1 - 1mg		

### Piece Count

25	21	13
----	----	----

### Total Weight

2.11111 kg	2.1111 kg	2.11 kg
------------	-----------	---------

Part #	Part #	Part #
<b>12522</b>	<b>12520</b>	<b>12518</b>

## SECONDARY CASE

Size	Part #	Price
100g - 1 mg	<b>11512</b>	\$30.00
100g - 10 mg	<b>11512</b>	30.00
100g - 1 g	<b>11512</b>	30.00

## CASE INSERT

Size	Part #	Price
100g - 1 mg	<b>11519</b>	\$30.00
100g - 10 mg	<b>11519</b>	30.00
100g - 1 g	<b>11518</b>	30.00

## ADDITIONAL ACCESSORIES

Part #	Description	Price
<b>36092</b>	Statement of Accuracy	\$45.00
<b>11758</b>	Leaf weight cover	35.00
<b>65640</b>	Tweezer	15.00
<b>25836</b>	Serial number	15.00
<b>152414</b>	Premium tweezer	35.00

Stainless Steel - NIST

# Metric Sets

Range: 2kg

CLASS F			OPTIONAL	REPLACEMENT CASES	
Set Size	Part #	Price	Traceable Certificate	Part #	Price
2kg - 1mg	<b>12528</b>	\$540.00	\$610.00	<b>11522</b>	\$145.00
(5) 2kg - 1mg	<b>12534</b>	850.00	778.00	<b>11523</b>	200.00
2kg - 10mg	<b>12526</b>	510.00	560.00	<b>11522</b>	145.00
(5) 2kg - 10mg	<b>12532</b>	845.00	700.00	<b>11523</b>	200.00
2kg - 1g	<b>12524</b>	470.00	380.00	<b>11522</b>	145.00
(5) 2kg - 1g	<b>12530</b>	785.00	545.00	<b>11523</b>	200.00

WEIGHT SET CONTENTS					
2kg - 1mg	(5) 2kg - 1mg	2kg - 10mg	(5) 2kg - 10mg	2kg - 1g	(5) 2kg - 1g
1 - 2 kg	5 - 2kg	1 - 2kg	5 - 2kg	1 - 2kg	5 - 2 kg
1 - 1 kg		1 - 1 kg		1 - 1 kg	
1 - 500g	5 - 500g	1 - 500g	5 - 500g	1 - 500g	5 - 500 g
2 - 200g	2 - 200g	2 - 200g	2 - 200g	2 - 200g	2 - 200g
1 - 100g	1 - 100g	1 - 100g	1 - 100g	1 - 100g	1 - 100 g
1 - 50g	1 - 50g	1 - 50g	1 - 50g	1 - 50g	1 - 50 g
2 - 20g	2 - 20g	2 - 20g	2 - 20g	2 - 20g	2 - 20 g
1 - 10g	1 - 10g	1 - 10g	1 - 10g	1 - 10g	1 - 10 g
1 - 5g	1 - 5g	1 - 5g	1 - 5g	1 - 5g	1 - 5 g
2 - 2g	2 - 2g	2 - 2g	2 - 2g	2 - 2g	2 - 2 g
1 - 1g	1 - 1g	1 - 1g	1 - 1g	1 - 1g	1 - 1 g
1 - 500mg	1 - 500mg	1 - 500mg	1 - 500mg		
2 - 200mg	2 - 200mg	2 - 200mg	2 - 200mg		
1 - 100mg	1 - 100mg	1 - 100mg	1 - 100mg		
1 - 50mg	1 - 50mg	1 - 50mg	1 - 50mg		
2 - 20mg	2 - 20mg	2 - 20mg	2 - 20mg		
1 - 10mg	1 - 10mg	1 - 10mg	1 - 10mg		
1 - 5mg	1 - 5mg				
2 - 2mg	2 - 2mg				
1 - 1mg	1 - 1mg				
<b>Piece Count</b>					
26	33	22	29	14	21
<b>Total Weight</b>					
4.11111 kg	13.11111 kg	4.1111 kg	13.1111 kg	4.110kg	13.11kg
<b>Part #</b>	<b>Part #</b>	<b>Part #</b>	<b>Part #</b>	<b>Part #</b>	<b>Part #</b>
<b>12528</b>	<b>12534</b>	<b>12526</b>	<b>12532</b>	<b>12524</b>	<b>12530</b>

SECONDARY CASE		
Size	Part #	Price
100g - 1mg	<b>11512</b>	\$30.00
100g - 10mg	<b>11512</b>	30.00
100g - 1g	<b>11512</b>	30.00



TEST WEIGHTS

www.ricelake.com | Phone: 800-472-6703

RICE LAKE

# Metric Sets

Range: 5 kg

TEST WEIGHTS

www.ricelake.com | Phone: 800-472-6703

RICELAKE

**CLASS F**

CLASS F			OPTIONAL	REPLACEMENT CASES	
Set Size	Part #	Price	Traceable Certificate	Part #	Price
5 kg - 1 mg	<b>12537</b>	\$725.00	\$740.00	<b>11524</b>	\$200.00
(2) 5 kg - 1 mg	<b>12542</b>	985.00	760.00	<b>11525</b>	200.00
5 kg - 10 mg	<b>12536</b>	670.00	650.00	<b>11524</b>	200.00
(2) 5 kg - 10 mg	<b>12539</b>	935.00	680.00	<b>11525</b>	200.00
5 kg - 1 g	<b>12535</b>	635.00	470.00	<b>11524</b>	200.00
(2) 5 kg - 1 g	<b>12538</b>	915.00	500.00	<b>11525</b>	200.00
5 kg (3)	<b>12562</b>	810.00	135.00	<b>11558</b>	200.00

**WEIGHT SET CONTENTS**

5kg - 1 mg	(2) 5kg - 1 mg	5kg - 10 mg	(2) 5kg - 10 mg	5kg - 1 g	(2) 5kg - 1 g	(3) 5kg
1 - 5kg	2 - 5kg	1 - 5kg	2 - 5kg	1 - 5kg	2 - 5kg	3 - 5kg
2 - 2kg	2 - 2kg	2 - 2kg	2 - 2kg	2 - 2kg	2 - 2kg	
1 - 1kg	1 - 1kg	1 - 1kg	1 - 1kg	1 - 1kg	1 - 1kg	
1 - 500g	5 - 500g	1 - 500g	5 - 500g	1 - 500g	5 - 500g	
2 - 200g	2 - 200g	2 - 200g	2 - 200g	2 - 200g	2 - 200g	
1 - 100g	1 - 100g	1 - 100g	1 - 100g	1 - 100g	1 - 100g	
1 - 50g	1 - 50g	1 - 50g	1 - 50g	1 - 50g	1 - 50g	
2 - 20g	2 - 20g	2 - 20g	2 - 20g	2 - 20g	2 - 20g	
1 - 10g	1 - 10g	1 - 10g	1 - 10g	1 - 10g	1 - 10g	
1 - 5g	1 - 5g	1 - 5g	1 - 5g	1 - 5g	1 - 5g	
2 - 2g	2 - 2g	2 - 2g	2 - 2g	2 - 2g	2 - 2g	
1 - 1g	1 - 1g	1 - 1g	1 - 1g	1 - 1g	1 - 1g	
1 - 500mg	1 - 500mg	1 - 500mg	1 - 500mg			
2 - 200mg	2 - 200mg	2 - 200mg	2 - 200mg			
1 - 100mg	1 - 100mg	1 - 100mg	1 - 100mg			
1 - 50 mg	1 - 50 mg	1 - 50 mg	1 - 50 mg			
2 - 20 mg	2 - 20 mg	2 - 20 mg	2 - 20 mg			
1 - 10 mg	1 - 10 mg	1 - 10 mg	1 - 10 mg			
1 - 5 mg	1 - 5 mg					
2 - 2 mg	2 - 2 mg					
1 - 1 mg	1 - 1 mg					
<b>Piece Count</b>						
28	33	24	29	16	21	3
<b>Total Weight</b>						
11.11 kg	18.11 kg	11.1111 kg	18.1111 kg	11.11 kg	18.110 kg	15 kg
<b>Part #</b>	<b>Part #</b>	<b>Part #</b>	<b>Part #</b>	<b>Part #</b>	<b>Part #</b>	<b>Part #</b>
<b>12537</b>	<b>12542</b>	<b>12536</b>	<b>12539</b>	<b>12535</b>	<b>12538</b>	<b>12562</b>

**SECONDARY CASE**

Size	Part #	Price
100g - 1 mg	<b>11512</b>	\$30.00
100g - 10 mg	<b>11512</b>	30.00
100g - 1 g	<b>11512</b>	30.00

**CASE INSERT**

Size	Part #	Price
100g - 1 mg	<b>11519</b>	\$30.00
100g - 10 mg	<b>11519</b>	30.00
100g - 1 g	<b>11518</b>	30.00

**ADDITIONAL ACCESSORIES**

Part #	Description	Price
<b>36092</b>	Statement of Accuracy	\$45.00
<b>11758</b>	Leaf weight cover	35.00
<b>65640</b>	Tweezer	15.00
<b>25836</b>	Serial number	15.00
<b>152414</b>	Premium tweezer	35.00





# Stainless Steel - NIST Avoirdupois Set

Range: 4 oz

CLASS F			OPTIONAL	REPLACEMENT CASES	
Set Size	Part #	Price	Traceable Certificate	Part #	Price
4oz - 1/32 oz	<b>12623</b>	\$170.00	\$205.00	<b>11510</b>	\$30.00
4oz - 0.05 oz	<b>12625</b>	190.00	185.00	<b>11510</b>	30.00
0.2lb - 0.001 lb	<b>12576</b>	180.00	250.00	<b>11512</b>	30.00
0.3lb - 0.001 lb	<b>12654</b>	315.00	250.00	<b>11565</b>	170.00

WEIGHT SET CONTENTS			
4oz - 1/32oz	4oz-0.05oz	0.2lb-0.001 lb	0.3lb-0.001 lb
1 - 4oz	1 - 4oz	2 - 0.2lb	1 - 0.3lb
1 - 2oz	1 - 2oz	1 - 0.1lb	1 - 0.2lb
1 - 1oz	1 - 1oz	1 - 0.05lb	1 - 0.1lb
1 - 1/2oz	1 - 0.5oz	2 - 0.02lb	1 - 0.05lb
1 - 1/4oz	2 - 0.2oz	1 - 0.01lb	1 - 0.03lb
1 - 1/8oz	1 - 0.1oz	1 - 0.005lb	1 - 0.02lb
1 - 1/16oz	1 - 0.05oz	2 - 0.002lb	1 - 0.01lb
2 - 1/32oz		1 - 0.001lb	1 - 0.005lb
			1 - 0.003lb
			1 - 0.002lb
			2 - 0.001lb
<b>Piece Count</b>			
9	8	11	12
<b>Total Weight</b>			
1/2lb	1lb 0.05oz	0.61 lb	0.722lb
<b>Part #</b>	<b>Part #</b>	<b>Part #</b>	<b>Part #</b>
<b>12623</b>	<b>12625</b>	<b>12576</b>	<b>12654</b>

CASE INSERT		
Size	Part #	Price
4oz - 1/32 oz	<b>11552</b>	\$20.00
4oz - 0.05 oz	<b>11553</b>	20.00
0.2lb - 0.001 lb	<b>11541</b>	20.00

ADDITIONAL ACCESSORIES		
Part #	Description	Price
<b>36092</b>	Statement of Accuracy	\$45.00
<b>25836</b>	Serial number	15.00



TEST WEIGHTS

www.ricelake.com | Phone: 800-472-6703

**RICE LAKE**

# Stainless Steel - NIST Avoirdupois Set

Range: 1 lb

TEST WEIGHTS

## CLASS F

Set Size	Part #	Price	OPTIONAL	REPLACEMENT CASES	
			Traceable Certificate	Part #	Price
1 lb - 1/32 oz (Fractional)	<b>12591</b>	\$285.00	\$270.00	<b>11544</b>	\$65.00
1 lb - 0.001 lb (Decimal)	<b>12593</b>	330.00	315.00	<b>11544</b>	65.00
1 lb - 0.05 oz (Combination)	<b>12595</b>	300.00	245.00	<b>11544</b>	65.00

## WEIGHT SET CONTENTS

1 lb - 1/32 oz	1 lb - 0.001 lb	1 lb - 0.05 oz
1 - 1 lb	1 - 1 lb	1 - 1 lb
1 - 8 oz	1 - 0.5 lb	1 - 8 oz
1 - 4 oz	2 - 0.2 lb	1 - 4 oz
1 - 2 oz	1 - 0.1 lb	1 - 2 oz
1 - 1 oz	1 - 0.05 lb	1 - 1 oz
1 - 1/2 oz	2 - 0.02 lb	1 - 0.5 oz
1 - 1/4 oz	1 - 0.01 lb	2 - 0.2 oz
1 - 1/8 oz	1 - 0.005 lb	1 - 0.1 oz
1 - 1/16 oz	2 - 0.002 lb	1 - 0.05 oz
2 - 1/32 oz	1 - 0.001 lb	
<b>Piece Count</b>		
11	13	10
<b>Total Weight</b>		
2 lb	2.1110 lb	1.990625 lb
<b>Part #</b>	<b>Part #</b>	<b>Part #</b>
<b>12591</b>	<b>12593</b>	<b>12595</b>

## SECONDARY CASE

Size	Part #	Price
1 lb - 1/32 oz	<b>11510</b>	\$30.00
1 lb - 0.001 lb	<b>11512</b>	30.00
1 lb - 0.05 oz	<b>11510</b>	30.00

## CASE INSERT

Size	Part #	Price
1 lb - 1/32 oz	<b>11552</b>	\$20.00
1 lb - 0.001 lb	<b>11553</b>	20.00
1 lb - 0.05 oz	<b>11541</b>	20.00



www.ricelake.com | Phone: 800-472-6703

**RICE LAKE**

# Stainless Steel - NIST Avoirdupois Set

Range: 2lb

CLASS F			OPTIONAL	REPLACEMENT CASES	
Set Size	Part #	Price	Traceable Certificate	Part #	Price
2lb - 1/32oz (Fractional)	<b>12597</b>	\$370.00	\$310.00	<b>11547</b>	\$65.00
(2) 2lb - 1/32oz (Fractional)	<b>12603</b>	480.00	350.00	<b>11548</b>	65.00
2lb - 0.001lb (Decimal)	<b>12599</b>	380.00	350.00	<b>11547</b>	65.00
(2) 2lb - 0.001lb (Decimal)	<b>12605</b>	480.00	400.00	<b>11548</b>	65.00
2lb - 0.05oz (Decimal)	<b>12601</b>	405.00	260.00	<b>11547</b>	65.00
(2) 2lb - 0.05oz (Combination)	<b>12607</b>	480.00	300.00	<b>11548</b>	65.00

## WEIGHT SET CONTENTS

2lb-1/32 oz	(2) 2lb - 1/32oz	2lb-0.001 lb	(2) 2lb - 0.001 lb	2lb-0.05 oz	(2) 2lb-0.05 oz
1 - 2lb	2 - 2lb	1 - 2lb	2 - 2lb	1 - 2lb	2 - 2lb
1 - 1lb	1 - 1lb	1 - 1lb	1 - 1lb	1 - 1lb	1 - 1lb
1 - 8oz	1 - 8oz	1 - 0.5lb	1 - 0.5lb	1 - 8oz	1 - 8oz
1 - 4oz	1 - 4oz	2 - 0.2lb	2 - 0.2lb	1 - 4oz	1 - 4oz
1 - 2oz	1 - 2oz	1 - 0.1lb	1 - 0.1lb	1 - 2oz	1 - 2oz
1 - 1oz	1 - 1oz	1 - 0.05lb	1 - 0.05lb	1 - 1oz	1 - 1oz
1 - 1/2oz	1 - 1/2oz	2 - 0.02lb	2 - 0.02lb	1 - 0.5oz	1 - 0.5oz
1 - 1/4oz	1 - 1/4oz	1 - 0.01lb	1 - 0.01lb	2 - 0.2oz	2 - 0.2oz
1 - 1/8oz	1 - 1/8oz	1 - 0.005lb	1 - 0.005lb	1 - 0.1oz	1 - 0.1oz
1 - 1/16oz	1 - 1/16oz	2 - 0.002lb	2 - 0.002lb	1 - 0.05oz	1 - 0.05oz
2 - 1/32oz	2 - 1/32oz	1 - 0.001lb	1 - 0.001lb		
<b>Piece Count</b>					
12	14	14	15	11	11
<b>Total Weight</b>					
4lb	6lb	4.108lb	6.1100lb	4.7875lb	6lb 0.05oz
<b>Part #</b>	<b>Part #</b>	<b>Part #</b>	<b>Part #</b>	<b>Part #</b>	<b>Part #</b>
<b>12597</b>	<b>12603</b>	<b>12599</b>	<b>12605</b>	<b>12601</b>	<b>12607</b>

## SECONDARY CASE

Size	Part #	Price
4oz - 1/32oz	<b>11510</b>	\$30.00
0.2lb - 0.001lb	<b>11512</b>	30.00
4oz - 0.05oz	<b>11510</b>	30.00

## CASE INSERT

Size	Part #	Price
2lb - 1/32oz	<b>11552</b>	\$20.00
2lb - 0.001lb	<b>11553</b>	20.00
2lb - 0.05oz	<b>11541</b>	20.00

## ADDITIONAL ACCESSORIES

Part #	Description	Price
<b>36092</b>	Statement of Accuracy	\$45.00
<b>25836</b>	Serial number	15.00



# Stainless Steel - NIST Avoirdupois Set

Range: 5 lb

TEST WEIGHTS

## CLASS F

Set Size	Part #	Price
5 lb - 1/32oz	<b>12615</b>	\$470.00
5 lb - 1/32oz	<b>12579</b>	965.00
5 lb - 0.001 lb	<b>12617</b>	475.00
5 lb - 0.001 lb (Combination)	<b>12582</b>	990.00
5 lb - 0.001 lb	<b>12634</b>	990.00
5 lb - 0.05 oz (Combination)	<b>12619</b>	485.00
(5) 5 lb - 0.05 oz (Combination)	<b>12636</b>	930.00
5 lb - 1 GN (21 lb Fractional US Postal Service)	<b>12627</b>	985.00
5 lb - 1 GN (31 lb 55 GN)	<b>12661</b>	1,125.00
5 lb x 6 (30 lb)	<b>12640</b>	870.00

## REPLACEMENT CASES

Traceable Certificate	Part #	Price
\$395.00	<b>11550</b>	\$195.00
670.00	<b>11542</b>	195.00
440.00	<b>11550</b>	195.00
715.00	<b>11542</b>	195.00
715.00	<b>11542</b>	195.00
370.00	<b>11550</b>	195.00
620.00	<b>11542</b>	195.00
750.00	<b>11554</b>	195.00
870.00	<b>11570</b>	195.00
340.00	<b>11559</b>	195.00

## SECONDARY CASE

Size	Part #	Price
5 lb - 1/32oz	<b>11510</b>	\$30.00
(5) 5 lb - 1/32oz	<b>11510</b>	30.00
5 lb - 0.001 lb	<b>11512</b>	30.00
(5) 5 lb - 0.001 lb (combination)	<b>11510 and 11512</b>	30.00
(5) 5 lb - 0.001 lb	<b>11512</b>	30.00
5 lb - 0.05 oz	<b>11510</b>	30.00
(5) 5 lb - 0.05 oz	<b>11510</b>	30.00
5 lb - 1 GN	<b>11510</b>	30.00

## ADDITIONAL ACCESSORIES

Part #	Description	Price
<b>36092</b>	Statement of Accuracy	\$45.00
<b>25836*</b>	Serial number	15.00



www.ricelake.com | Phone: 800-472-6703

**RICE LAKE**

838

Stainless Steel - NIST  
**Avoirdupois Set**

Range: 5lb

**WEIGHT SET CONTENTS**

5 lb - 1/32 oz	5 lb - 1/32 oz	5 lb - 0.001 lb	5lb - 0.001lb	5 lb - 0.001 lb	5 lb - 0.05 oz	(5) 5 lb - 0.05 oz	5 lb - 1 GN	5 lb - 1GN	(6) 5 lb
1 - 5lb	5 - 5lb	1 - 5lb	5 - 5lb	5 - 5lb	1 - 5lb	5 - 5lb	3 - 5lb	5 - 5lb	6 - 5lb
2 - 2lb	5 - 1lb	2 - 2lb	5 - 1lb	5 - 1lb	2 - 2lb	5 - 1lb	5 - 1lb	5 - 1lb	
1 - 1lb	1 - 8oz	1 - 1lb	1 - 8oz	1 - 0.5lb	1 - 1lb	1 - 8oz	1 - 8oz	1 - 8oz	
1 - 8oz	1 - 4oz	1 - 0.5lb	1 - 4oz	2 - 0.2lb	1 - 8oz	1 - 4oz	1 - 4oz	1 - 4oz	
1 - 4oz	1 - 2oz	2 - 0.2lb	2 - 0.2lb	1 - 0.1lb	1 - 4oz	1 - 2oz	1 - 2oz	1 - 2oz	
1 - 2oz	1 - 1oz	1 - 0.1lb	1 - 2oz	1 - 0.05lb	1 - 2oz	1 - 1oz	1 - 1oz	1 - 1oz	
1 - 1oz	1 - 1/2oz	1 - 0.05lb	1 - 0.1lb	2 - 0.02lb	1 - 1oz	1 - 0.5oz	1 - 1/2oz	1 - 1/2oz	
1 - 1/2oz	1 - 1/4oz	2 - 0.02lb	1 - 1oz	1 - 0.01lb	1 - 0.5oz	2 - 0.20oz	1 - 1/4oz	1 - 1/4oz	
1 - 1/4oz	1 - 1/8oz	1 - 0.01lb	1 - 0.05lb	1 - 0.005lb	2 - 0.20oz	1-0.05oz	1 - 1/8oz	1 - 1/8oz	
1 - 1/8oz	1 - 1/16oz	1 - 0.005lb	1 - 1/2oz	2 - 0.002lb	1 - 0.1oz		1 - 1/16oz	1 - 1/16oz	
1 - 1/16oz	2 - 1/32oz	2 - 0.002lb	2 - 0.02lb	1-0.001lb	1-0.05oz		2 - 1/32oz	2 - 1/32oz	
2 - 1/32oz		1-0.001lb	1 - 1/4oz				2 - 10GN	1 - 20GN	
			1 - 0.01lb				2 - 5GN	2 - 10GN	
			1 - 1/8oz				2 - 2GN	2 - 5GN	
			1 - 0.005lb				1 - 1GN	2 - 2GN	
			1 - 1/16oz					1 - 1GN	
			2 - 0.002lb						
			2 - 1/32oz						
			1-0.001lb						
<b>Piece Count</b>									
14	20	16	31	22	13	18	26	28	6
<b>Total Weight</b>									
11 lb	31 lb	11.11 lb	31.61 lb	31.11 lb	11 lb 0.05 oz	31 lb 0.05 oz	21 lb 55 GN	31 lb 55 GN	30 lb
<b>Part #</b>	<b>Part #</b>	<b>Part #</b>	<b>Part #</b>	<b>Part #</b>	<b>Part #</b>	<b>Part #</b>	<b>Part #</b>	<b>Part #</b>	<b>Part #</b>
<b>12615</b>	<b>12579</b>	<b>12617</b>	<b>12582</b>	<b>12634</b>	<b>12619</b>	<b>12636</b>	<b>12627</b>	<b>12661</b>	<b>12640</b>

TEST WEIGHTS

www.ricelake.com | Phone: 800-472-6703

RICE LAKE

# Stainless Steel - NIST Avoirdupois Set

Range: 10lb

TEST WEIGHTS

## CLASS F

Set Size	Part #	Price	OPTIONAL Traceable Certificate	REPLACEMENT CASES Part #	Price
(3) 10lb	<b>12638</b>	\$750.00	\$200.00	<b>11558</b>	\$200.00
10 lb - 1/32oz	<b>12609</b>	690.00	445.00	<b>11549</b>	195.00
10 lb - 0.001 lb	<b>12611</b>	675.00	490.00	<b>11549</b>	195.00
10 lb - 0.05 oz (21 lb x 0.05 oz Combination)	<b>12613</b>	730.00	400.00	<b>11549</b>	195.00
10 lb - 1/4 oz	<b>12573</b>	1,070.00	455.00	<b>11540</b>	195.00
10 lb - 1/32oz	<b>12642</b>	980.00	445.00	<b>11562</b>	195.00
10 lb - 0.001 lb	<b>12588</b>	1,175.00	740.00	<b>11543</b>	195.00
10 lb - 0.001 lb	<b>12644</b>	930.00	490.00	<b>11562</b>	195.00
10 lb - 0.001 lb (Combination)	<b>12648</b>	1,110.00	535.00	<b>11562</b>	195.00
10 lb - 0.05 oz (Combination)	<b>12646</b>	1,065.00	400.00	<b>11562</b>	195.00
10 lb - 1/32oz	<b>12628</b>	1,275.00	715.00	<b>11555</b>	195.00
10 lb - 0.001 lb	<b>12621</b>	1,395.00	760.00	<b>11555</b>	195.00
10 lb - 0.05 oz (Combination)	<b>12632</b>	1,420.00	695.00	<b>11555</b>	195.00
10 lb - 0.001 lb (51.61 lb Combination)	<b>12650</b>	1,435.00	760.00	<b>11563</b>	195.00

## SECONDARY CASE

Size	Part #	Price
10 lb - 0.001 lb	<b>11512</b>	\$30.00
10 lb - 1/32oz	<b>11510</b>	30.00

## CASE INSERT

Size	Part #	Price
10 lb - 0.001 lb	<b>11541</b>	\$20.00
10 lb - 1/32oz	<b>11552</b>	20.00
10 lb - 0.05 oz	<b>11553</b>	20.00

## ADDITIONAL ACCESSORIES

Part #	Description	Price
<b>36092</b>	Statement of Accuracy	\$45.00
<b>11758</b>	Leaf Weight Cover	35.00
<b>65640</b>	Tweezer	15.00
<b>25836</b>	Serial number	15.00
<b>152414</b>	Premium tweezer	35.00



www.ricelake.com | Phone: 800-472-6703

**RICE LAKE**

Stainless Steel - NIST  
**Avoirdupois Set**  
 Range: 10lb

**WEIGHT SET CONTENTS**

(3) 10lb	10lb - 1/32oz	10lb - 0.001lb	10lb - 0.05oz	10lb - 1/4oz	10lb - 1/32oz	10lb - 0.001lb	10lb - 0.001lb	10lb - 0.001lb	10lb - 0.05oz (Combination)	10lb - 1/32oz	10lb - 0.001lb	10lb - 0.05oz	10lb - 0.001lb
3-10lb	1 - 10lb	1 - 10lb	1 - 10lb	2 - 10lb	2 - 10lb	2 - 10lb	2 - 10lb	2 - 10lb	2 - 10lb	3 - 10lb	3 - 10lb	3 - 10lb	3 - 10lb
	1 - 5lb	1 - 5lb	1 - 5lb	1 - 5lb	1 - 5lb	1 - 5lb	1 - 5lb	1 - 5lb	1 - 5lb	3 - 5lb	3 - 5lb	3 - 5lb	3 - 5lb
	2 - 2lb	2 - 2lb	2 - 2lb	5 - 1lb	2 - 2lb	5 - 1lb	2 - 2lb	2 - 2lb	2 - 2lb	5 - 1lb	5 - 1lb	5 - 1lb	5 - 1lb
	1 - 1lb	1 - 1lb	1 - 1lb	3 - 4oz	1 - 1lb	3 - 4oz	1 - 1lb	1 - 1lb	1 - 1lb	1 - 8oz	1 - 0.5lb	1 - 8oz	1 - 8oz
	1 - 8oz	1 - 0.5lb	1 - 8oz	3 - 1oz	1 - 8oz	2 - 0.2lb	1 - 0.5lb	1 - 8oz	1 - 8oz	1 - 4oz	2 - 0.2lb	1 - 4oz	1 - 4oz
	1 - 4oz	2 - 0.2lb	1 - 4oz	2 - 1/2oz	1 - 4oz	1 - 0.1lb	2 - 0.2lb	1 - 4oz	1 - 4oz	1 - 2oz	1 - 0.1lb	1 - 2oz	2 - 0.2lb
	1 - 2oz	1 - 0.1lb	1 - 2oz	2 - 1/4oz	1 - 2oz	3 - 1oz	1 - 0.1lb	1 - 2oz	1 - 2oz	1 - 1oz	1 - 0.05lb	1 - 1oz	1 - 2oz
	1 - 1oz	1 - 0.05lb	1 - 1oz		1 - 1oz	1 - 0.05lb	1 - 0.05lb	1 - 1oz	1 - 1oz	1 - 1/2oz	2 - 0.02lb	1 - 0.5oz	1 - 0.1lb
	1 - 1/2oz	2 - 0.02lb	1 - 0.5oz		1 - 1/2oz	2 - 1/2oz	2 - 0.02lb	1 - 1/2oz	1 - 0.5oz	1 - 1/4oz	1 - 0.01lb	2 - 0.20oz	1 - 1oz
	1 - 1/4oz	1 - 0.01lb	1 - 0.2oz		1 - 1/4oz	2 - 0.02lb	1 - 0.01lb	1 - 1/4oz	2 - 0.2oz	1 - 1/8oz	1 - 0.005lb	1 - 0.1oz	1 - 0.05lb
	1 - 1/8oz	1 - 0.005lb	1 - 0.1oz		1 - 1/8oz	2 - 1/4oz	1 - 0.005lb	1 - 1/8oz	1 - 0.1oz	1 - 1/16oz	2 - 0.002lb	1 - 0.05oz	1 - 1/2oz
	1 - 1/16oz	2 - 0.002lb	1 - 0.05oz		1 - 1/16oz	1 - 0.01lb	2 - 0.002lb	1 - 1/16oz	1 - 0.05oz	2 - 1/32oz	1 - 0.001lb		2 - 0.02lb
	2 - 1/32oz	1 - 0.001lb			2 - 1/32oz	1 - 0.005lb	1 - 0.001lb	2 - 1/32oz					1 - 1/4oz
						2 - 0.002lb		2 - 0.2lb					1 - 0.01lb
						1 - 0.001lb		1 - 0.1lb					1 - 1/8oz
								1 - 0.05lb					1 - 0.005lb
								2 - 0.02lb					1 - 1/16oz
								1 - 0.01lb					2 - 0.002lb
								1 - 0.005lb					2 - 1/32oz
								2 - 0.002lb					1 - 0.001lb
								1 - 0.001lb					

**Piece Count**

3	15	17	13	18	16	29	18	27	15	21	23	20	32
---	----	----	----	----	----	----	----	----	----	----	----	----	----

**Total Weight**

30lb	21lb	21.11lb	21lb 0.05oz	31lb 1/2oz	31lb	31lb 1/2oz	31.1100lb	31lb	31lb 0.05oz	51lb	51.11lb	51lb 0.05oz	51.6100lb
Part #	Part #	Part #	Part #	Part #	Part #	Part #	Part #	Part #	Part #	Part #	Part #	Part #	Part #
12638	12609	12611	12613	12573	12642	12588	12644	12648	12646	12628	12621	12632	12650

TEST WEIGHTS

www.ricelake.com | Phone: 800-472-6703

RICE LAKE

## SPECIALTY WEIGHTS - NIST

Unique weights designed or built for custom applications or tolerances

### Applications:

- Tolerance test or checking
- Equipment verification in unique unit of measurement
- Slotted weights for suspending verification of weight
- Fork lift weights for accuracy checking of fork lift scale

### Styles Available:

- Cube
- Ring
- Lift truck weights
- Hook weights
- Stainless Steel slotted weights

### Unique Units of Measures:

- Penny weight
- Grain
- Troy ounce

### Features:

- Nominal value marked on weights
- Cavity for adjustment
- Cube weight sets – designed as sealer's kits for calibration adjustments





# Metric Cube and Ring Weights; Avoirdupois Ring Weights

## CUBE CLASS F

Weight	Part #	Width	Length	Height	Price	Traceable Certificate
2 lb	<b>12649</b>	2.4	1 in (25.4 mm)	3 in	\$130.00	\$60.00
1 lb	<b>12651</b>	1.2	1 in (25.4 mm)	3 in	120.00	60.00
8 oz	<b>12653</b>	1 9/10 in (48.3 mm)	1 in (25.4 mm)	1 in (25.4 mm)	105.00	50.00
2 oz	<b>12658</b>	0.70	0.60	1 in (25.4 mm)	75.00	50.00
4 oz	<b>12655</b>	73/100 in (18.5 mm)	1 in (25.4 mm)	309/1000 in (33.3 mm)	85.00	50.00
1 kg	<b>12557</b>	1 in (25.4 mm)	3 3/8 in (85.6 mm)	2 1/2 in (62.8 mm)	130.00	50.00
500 g	<b>12552</b>	1 in (25.4 mm)	3 13/32 in (86.5 mm)	1 1/4 in (31.8 mm)	105.00	50.00
300 g	<b>12547</b>	2 1/32 in (51.6 mm)	1 1/4 in (31.8 mm)	1 in (25.4 mm)	95.00	50.00
200 g	<b>12544</b>	1 1/4 in (31.0 mm)	1 3/8 in (34.8 mm)	1 in (25.4 mm)	85.00	50.00
100 g	<b>12541</b>	3/4 in (19.1 mm)	1 7/32 in (31.0 mm)	1 in (25.4 mm)	75.00	35.00

## OPTIONAL

## RING CLASS F

Weight	Part #	Outside Dia.	Height	Inside Dia.	Price	Traceable Certificate
500 g	<b>12566</b>	3 in (76.2 mm)	37/64 in (14.7 mm)	25/64 in (9.9 mm)	\$115.00	\$50.00
200 g	<b>12563</b>	2 in (50.8 mm)	17/32 in (13.5 mm)	25/64 in (9.9 mm)	90.00	50.00
100 g	<b>12561</b>	1 1/2 in (38.1 mm)	1/2 in (12.7 mm)	25/64 in (9.9 mm)	75.00	35.00
50 g	<b>12560</b>	1 1/2 in (38.1 mm)	1/4 in (6.4 mm)	25/64 in (9.9 mm)	65.00	35.00
25 g	<b>12559</b>	1 in (25.4 mm)	5/16 in (7.9 mm)	25/64 in (9.9 mm)	50.00	35.00

## OPTIONAL

## RING CLASS F

Weight	Part #	Outside Dia.	Height	Inside Dia.	Price	Traceable Certificate
5 lb	<b>12672</b>	4 in (101.6 mm)	1 7/16 in (36.5 mm)	25/64 in (9.9 mm)	\$100.00	\$75.00
3 lb	<b>12671</b>	3 in (76.2 mm)	1 35/64 in (36.3 mm)	25/64 in (9.9 mm)	80.00	75.00
2 lb	<b>12670</b>	3 in (76.2 mm)	1 1/32 in (26.2 mm)	25/64 in (9.9 mm)	65.00	60.00
1 lb	<b>12669</b>	3 in (76.2 mm)	33/64 in (13.1 mm)	25/64 in (9.9 mm)	65.00	60.00
8 oz	<b>12668</b>	2 in (50.8 mm)	39/64 in (15.5 mm)	25/64 in (9.9 mm)	31.00	35.00
4 oz	<b>12667</b>	1 1/2 in (38.1 mm)	9/16 in (14.3 mm)	25/64 in (9.9 mm)	31.00	35.00
2 oz	<b>12666</b>	1 1/2 in (38.1 mm)	9/32 in (7.1 mm)	25/64 in (9.9 mm)	31.00	35.00
1 oz	<b>12665</b>	1 in (25.4 mm)	11/32 in (8.7 mm)	25/64 in (9.9 mm)	31.00	35.00
1/2 oz	<b>12664</b>	1 in (25.4 mm)	11/64 in (4.4 mm)	25/64 in (9.9 mm)	31.00	35.00
1/4 oz	<b>12663</b>	1 in (25.4 mm)	3/32 in (2.4 mm)	25/64 in (9.9 mm)	31.00	35.00

## OPTIONAL

## ADDITIONAL ACCESSORIES

Part #	Description	Price
<b>36092</b>	Statement of Accuracy	\$45.00
<b>25836</b>	Serial number	15.00



## Avoirdupois Slotted Weights and Troy Cylindrical/Leaf Weights

TROY OUNCE CLASS F					OPTIONAL
Weight	Part #	Height	Diameter	Price	Traceable Certificate
500oz t	12719	6 5/16 in (160.3 mm)	5 in (127.0 mm)	\$975.00	\$75.00
200oz t	12718	3 3/4 in (95.3 mm)	4 25/32 in (121.4 mm)	425.00	75.00
100oz t	12717	3 13/16 in (96.1 mm)	3 in (75.4 mm)	255.00	75.00
50oz t	12716	2 5/8 in (66.7 mm)	2 21/32 in (67.5 mm)	145.00	75.00
20oz t	12715	2 1/4 in (56.6 mm)	1 3/4 in (44.1 mm)	75.00	60.00
10oz t	12714	1 3/8 in (34.9 mm)	1 29/32 in (48.4 mm)	60.00	35.00
5oz t	12713	1 3/16 in (30.2 mm)	1 13/32 in (35.7 mm)	60.00	35.00
2oz t	12712	7/8 in (22.2 mm)	31/32 in (24.6 mm)	35.00	35.00
1oz t	12711	7/8 in (21.2 mm)	5/8 in (15.9 mm)	32.00	35.00
1/4oz t	12709	11/16 in (16.8 mm)	3/8 in (9.1 mm)	40.00	35.00
1/8oz t	12708	5/16 in (7.9 mm)	15/32 in (11.9 mm)	40.00	35.00
1/16oz t	12707	3/8 in (9.1 mm)	1/4 in (6.2 mm)	40.00	35.00
1/32oz t	12706	5/16 in (7.7 mm)	3/16 in (4.7 mm)	40.00	35.00
0.5oz t	12705	1/2 in (12.7 mm)	23/32 in (18.3 mm)	40.00	35.00
0.2oz t	12704	1/2 in (12.6 mm)	3/8 in (9.3 mm)	40.00	35.00
0.1oz t	12703	5/16 in (7.9 mm)	13/32 in (10.3 mm)	40.00	35.00
0.05oz t*	12702	1/4 in (6.4 mm)	11/32 in (8.7 mm)	40.00	35.00
0.02oz t*	12701	-	-	22.00	35.00
0.01oz t*	12700	-	-	22.00	35.00
0.005oz t*	12699	-	-	22.00	35.00

\* Leaf weights



Troy  
Leaf weights not pictured

# Penny Cylindrical, Leaf, Grain and Lift Truck Weights

### PENNY WEIGHT CLASS F

Weight	Part #	Price	OPTIONAL Traceable Certificate
20 dwt	12698	\$30.00	\$35.00
10 dwt	12697	30.00	35.00
5 dwt	12696	30.00	35.00
2 dwt	12695	30.00	35.00
1 dwt	12694	30.00	35.00

### PENNY WEIGHT LEAF CLASS F

Weight	Part #	Price	OPTIONAL Traceable Certificate
0.5 dwt	12693	\$22.00	\$35.00
0.2 dwt	12692	22.00	35.00
0.1 dwt	12691	22.00	35.00

### GRAIN CLASS F

Weight	Part #	Price	OPTIONAL Traceable Certificate
1 GN	12726	\$20.00	\$35.00
2 GN	12727	23.00	35.00
10 GN	12733	23.00	35.00
20 GN	12736	30.00	35.00

### ADDITIONAL ACCESSORIES

Part #	Description	Price
36092	Statement of Accuracy	\$45.00
25836	Serial number	15.00



*Penny and Grain*

### LIFT TRUCK WEIGHTS - MEETS TOLERANCE OF CLASS 6

Part #	Description	Price
120160	1,000 lb	\$2,150.00
120162	2,000 lb	6,400.00



*Lift Truck Weight*

# Specialty - NIST Specialty Weights/Cube Weights Sets

TEST WEIGHTS

## CUBE WEIGHT SETS AVOIRDUPOIS CLASS F

Set Size	Part #	Price	OPTIONAL Traceable Certificate	REPLACEMENT CASES Part #	Price
8oz - 1/16oz	<b>12630</b>	\$275.00	\$220.00	<b>11510</b>	30.00
(3) 2lb - 1/16oz	<b>12652</b>	815.00	364.00	<b>11569</b>	180.00
(3) 2lb - .001lb	<b>12659</b>	915.00	437.00	<b>11569</b>	180.00
(14) 2lb - 1/16oz	<b>12585</b>	1,335.00	868.00	<b>12630</b>	275.00

## CUBE WEIGHT SETS METRIC

Set Size	Part #	Price	OPTIONAL Traceable Certificate	REPLACEMENT CASES Part #	Price
300g - 10g	<b>12545</b>	\$280.00	270.00	<b>11510</b>	\$30.00
1kg - 1mg	<b>12553*</b>	1,350.00	949.00	<b>12545</b>	280.00
1kg - 1mg	<b>12555*</b>	1,155.00	613.00	<b>11569</b>	180.00

\* Glass Bead Finish

## WEIGHT SET CONTENTS

300g - 10g	8oz and 1/16oz	2lb x 1/16oz	2lb x .001lb	2lb x 1/16oz	1kg - 1mg	1kg - 1mg
1 - 300g*	1 - 8oz*	3 - 2lb*	3 - 2lb*	14 - 2lb*	1 - 1kg*	3 - 1kg*
1 - 200g*	1 - 4oz*	1 - 1lb*	1 - 1lb*	2 - 1lb*	1 - 500g+	1 - 500g+
1 - 100g*	1 - 2oz*	1 - 8oz*	1 - 0.3lb	1 - 8oz*	1 - 300g*	1 - 300g*
1 - 50g	1 - 1oz	1 - 4oz*	1 - 0.2lb	1 - 4oz*	1 - 200g*	1 - 200g*
1 - 30g	1 - 1/2oz	1 - 2oz*	1 - 0.1lb	1 - 2oz*	1 - 100g*	1 - 100g*
1 - 20g	1 - 1/4oz	1 - 1oz	1 - 0.05lb	1 - 1oz	1 - 50g	1 - 50g
1 - 10g	1 - 1/8oz	1 - 1/2oz	1 - 0.03lb	1 - 1/2oz	1 - 30g	1 - 30g
	2 - 1/16oz	1 - 1/4oz	1 - 0.02lb	1 - 1/4oz	1 -- 20g	1 -- 20g
		1 - 1/8oz	1 - 0.01lb	1 - 1/8oz	1 - 10g	1 - 10g
		2 - 1/16oz	1 - 0.005lb	2 - 1/16oz	1 - 5g	1 - 5g
			1 - 0.003lb		1 - 3g	1 - 3g
			1 - 0.002lb		1 - 2g	1 - 2g
			2 - 001lb		1 - 1g	1 - 1g
					1 - 500mg	1 - 500mg
					1 - 300mg	1 - 300mg
					1 - 200mg	1 - 200mg
					1 - 100mg	1 - 100mg
					1 - 50mg	1 - 50mg
					1 - 30mg	1 - 30mg
					1 - 20mg	1 - 20mg
					1 - 10mg	1 - 10mg
					1 - 5mg	1 - 5mg
					1 - 3mg	1 - 3mg
					1 - 2mg	1 - 2mg
					1 - 1mg	1 - 1mg
<b>Piece Count</b>						
7	9	13	16	25	25	27
<b>Total Weight</b>						
710g	1lb	8lb	7.72lb	31lb	2222.221g	4222.221g
<b>Part #</b>	<b>Part #</b>	<b>Part #</b>	<b>Part #</b>	<b>Part #</b>	<b>Part #</b>	<b>Part #</b>
<b>12545</b>	<b>12630</b>	<b>12652</b>	<b>12659</b>	<b>12585</b>	<b>12553</b>	<b>12555</b>

\*Cube Weight

## CASE INSERT

Size	Part #	Price
300g - 10g	<b>11526</b>	\$32.00
5g - 1mg	<b>11527</b>	30.00
(2) 50g - 1mg	<b>11528</b>	32.00
1kg - 1mg	<b>11526</b>	32.00
(3) 1kg - 1mg	<b>11526</b>	32.00

## ADDITIONAL ACCESSORIES

Part #	Description	Price
<b>36092</b>	Statement of Accuracy	\$45.00
<b>11758</b>	Leaf weight cover	35.00
<b>65640</b>	Tweezer	15.00
<b>25836</b>	Serial number	15.00
<b>152414</b>	Premium tweezer	35.00

www.ricelake.com | Phone: 800-472-6703

RICELAKE

# Avoirdupois and Metric Individual Hook Weights

## HOOK WEIGHTS METRIC CLASS 6

OPTIONAL

Weight	Part #	Diameter	Hanging Height	Opening Diameter	Price	Traceable Certificate
25kg	<b>12720</b>	5 31/32 in (151.6 mm)	9 3/16 in (233.4 mm)	1/4 in (6.4 mm)	\$765.00	\$70.00
20kg	<b>12725</b>	5 31/32 in (151.6 mm)	8 3/8 in (212.7 mm)	1/4 in (6.4 mm)	750.00	70.00
10kg	<b>12732</b>	4 in (101.6 mm)	9 1/16 in (230.2 mm)	1/4 in (6.4 mm)	520.00	70.00
5kg	<b>12735</b>	3 3/4 in (95.3 mm)	6 11/32 in (161.1 mm)	1/4 in (6.4 mm)	255.00	70.00
4kg	<b>161608</b>	3 1/2 in (89 mm)	6.12 in (155 mm)	1/4 in (6.4 mm)	250.00	70.00
3kg	<b>96403</b>	2 5/8 in (66.7 mm)	5 1/16 in (128.6 mm)	1/4 in (6.4 mm)	240.00	70.00
2kg	<b>12739</b>	2 5/8 in (66.8 mm)	5 17/32 in (135.7 mm)	1/4 in (6.4 mm)	180.00	70.00
1kg	<b>12744</b>	2 in (50.8 mm)	5 3/8 in (136.5 mm)	1/4 in (6.4 mm)	100.00	50.00
500g	<b>12747</b>	1 5/8 in (41.3 mm)	4 1/2 in (114.3 mm)	5/32 in (4.0 mm)	85.00	50.00
300g	<b>96404</b>	1 1/4 in (31.8 mm)	4 1/2 in (114.3 mm)	5/32 in (4.0 mm)	85.00	50.00
200g	<b>12748</b>	1 1/8 in (28.6 mm)	3 in (76.2 mm)	3/32 in (2.4 mm)	85.00	50.00
100g	<b>12749</b>	1 in (25.4 mm)	2 3/8 in (60.3 mm)	3/32 in (2.4 mm)	75.00	35.00
50g	<b>12750</b>	3/4 in (19.1 mm)	2 1/4 in (57.2 mm)	3/32 in (2.4 mm)	75.00	35.00
30g	<b>96405</b>	5/8 in (15.9 mm)	2 1/8 in (54.0 mm)	3/32 in (2.4 mm)	75.00	35.00
20g	<b>12751</b>	5/8 in (15.9 mm)	2 1/8 in (54.0 mm)	3/32 in (2.4 mm)	75.00	35.00
10g	<b>12754</b>	1/2 in (12.7 mm)	2 in (50.8 mm)	3/32 in (2.4 mm)	55.00	35.00
5g	<b>12757</b>	1/8 in (3.2 mm)	2 5/32 in (54.8 mm)	3/16 in (4.7 mm)	50.00	35.00
3g	<b>96406</b>	3/32 in (2.4 mm)	2.32 in (58.9 mm)	3/16 in (4.7 mm)	50.00	35.00
2g	<b>12762</b>	3/32 in (2.4 mm)	1 7/32 in (31.0 mm)	3/16 in (4.7 mm)	45.00	35.00
1g	<b>12766</b>	1/16 in (1.6 mm)	1 21/32 in (42.1 mm)	3/16 in (4.7 mm)	45.00	35.00

## HOOK WEIGHTS AVOIRDUPOIS CLASS 6

OPTIONAL

50 lb	<b>12894</b>	5 31/32 in (151.6 mm)	9 1/4 in (235.0 mm)	1/4 in (6.4 mm)	\$765.00	\$75.00
25 lb	<b>96408</b>	4 19/32 in (116.7 mm)	5 3/4 in (146.1 mm)	1/4 in (6.4 mm)	695.00	75.00
20 lb	<b>12895</b>	4 in (101.6 mm)	9 3/16 in (233.3 mm)	1/4 in (6.4 mm)	500.00	75.00
10 lb	<b>12896</b>	3 1/2 in (89.9 mm)	6 1/4 in (158.8 mm)	1/4 in (6.4 mm)	250.00	75.00
5 lb	<b>12897</b>	2 5/8 in (66.6 mm)	6 1/2 in (165.1 mm)	1/4 in (6.4 mm)	170.00	75.00
3 lb	<b>96409</b>	2 1/4 in (57.2 mm)	4 1/32 in (102.4 mm)	1/4 in (6.4 mm)	160.00	75.00
2 lb	<b>12898</b>	2 in (50.8 mm)	5 in (127.0 mm)	1/4 in (6.4 mm)	100.00	60.00
1 lb	<b>12899</b>	1 5/8 in (41.3 mm)	4 1/2 in (114.3 mm)	5/32 in (4.0 mm)	75.00	60.00
0.2 lb	<b>96410</b>	1 in (25.4 mm)	2 5/16 in (58.7 mm)	3/32 in (2.4 mm)	65.00	35.00
0.1 lb	<b>96411</b>	3/4 in (19.1 mm)	2 5/32 in (54.8 mm)	3/32 in (2.4 mm)	65.00	35.00
8 oz	<b>12900</b>	1 1/4 in (31.8 mm)	4 in (101.6 mm)	5/32 in (4.0 mm)	65.00	35.00
4 oz	<b>12901</b>	1 in (25.4 mm)	2 1/4 in (57.2 mm)	3/32 in (2.4 mm)	65.00	35.00
2 oz	<b>12902</b>	13/16 in (20.6 mm)	2 1/4 in (57.2 mm)	3/32 in (2.4 mm)	65.00	35.00
1 oz	<b>12903</b>	5/8 in (15.9 mm)	2 1/4 in (57.2 mm)	3/32 in (2.4 mm)	65.00	35.00
1/2 oz	<b>12904</b>	17/32 in (13.5 mm)	2 29/32 in (73.8 mm)	3/32 in (2.4 mm)	60.00	35.00
1/4 oz	<b>12905</b>	5/32 in (4.0 mm)	1 13/16 in (46.0 mm)	3/16 in (4.7 mm)	45.00	35.00
1/8 oz	<b>12906</b>	1/8 in (3.2 mm)	1 1/8 in (28.6 mm)	3/16 in (4.7 mm)	45.00	35.00
1/16 oz	<b>12907</b>	3/32 in (2.4 mm)	1 1/4 in (31.8 mm)	3/16 in (4.7 mm)	45.00	35.00
1/32 oz	<b>12908</b>	1/16 in (1.6 mm)	1 13/32 in (35.7 mm)	3/16 in (4.7 mm)	45.00	35.00

## ADDITIONAL ACCESSORIES

Part #	Description	Price
<b>36092</b>	Statement of Accuracy	\$45.00
<b>25836</b>	Serial number	15.00



Hook Weight (5g - 1g)

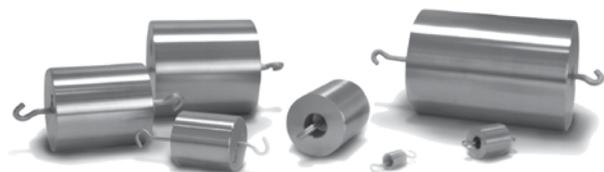

Hook Weight

## Avoirdupois and Metric Individual Hangers and Slotted Weights

## CLASS 7 STAINLESS STEEL WEIGHT HANGER

OPTIONAL

Weight	Part #	Diameter	Length	Total Cap	Price	Traceable Certificate
5 lb	<b>12846</b>	4 in (101.6 mm)	37 1/4 in	500 lb	\$260.00	\$75.00
3 kg	<b>156937</b>	4 in (101.6 mm)	38 3/16 in	250 kg	270.00	70.00

## AVOIRDUPOIS SLOTTED CLASS F

OPTIONAL

Weight	Part #	Diameter	Height	Slot Width	Price	Traceable Certificate
10 lb	<b>12589</b>	4 in (101.6 mm)	3 1/8 in (79.4 mm)	1/2 in (12.7 mm)	\$485.00	\$75.00
5 lb	<b>12586</b>	4 in (101.6 mm)	1 9/16 in (39.7 mm)	1/2 in (12.7 mm)	305.00	75.00
2 lb	<b>12577</b>	3 in (76.2 mm)	1 9/64 in (29.0 mm)	1/2 in (12.7 mm)	190.00	60.00
1 lb	<b>12574</b>	3 in (76.2 mm)	19/32 in (15.1 mm)	1/2 in (12.7 mm)	160.00	60.00
8 oz	<b>12583</b>	2 in (50.8 mm)	45/64 in (17.9 mm)	1/2 in (12.7 mm)	140.00	35.00
4 oz	<b>12580</b>	1 1/2 in (38.1 mm)	11/16 in (17.5 mm)	1/2 in (12.7 mm)	110.00	35.00

## AVOIRDUPOIS SLOTTED CLASS F

OPTIONAL

Weight	Part #	Diameter	Height	Slot Width	Price	Traceable Certificate
5 kg	<b>156931</b>	4 in (101.6 mm)	3 1/8 in (79.4 mm)	1/2 in (12.7 mm)	\$485.00	\$70.00
2 kg	<b>156932</b>	4 in (101.6 mm)	1 9/16 in (39.7 mm)	1/2 in (12.7 mm)	340.00	70.00
1 kg	<b>156933</b>	3 in (76.2 mm)	1.27 in (32.3 mm)	1/2 in (12.7 mm)	195.00	50.00
500 g	<b>156934</b>	3 in (76.2 mm)	0.836 in (21.2 mm)	1/2 in (12.7 mm)	175.00	50.00
200 g	<b>156935</b>	1.5 in (38.1 mm)	0.801 in (20.4 mm)	1/2 in (12.7 mm)	145.00	35.00
100 g	<b>156936</b>	1.5 in (38.1 mm)	0.601 in (15.3 mm)	1/2 in (12.7 mm)	95.00	35.00

## ADDITIONAL ACCESSORIES

Part #	Description	Price
<b>36092</b>	Statement of Accuracy	\$45.00
<b>25836</b>	Serial number	15.00



Slotted

# STAINLESS STEEL - ASTM

## Applications

- Calibrating Class I & II balances
- ASTM Class 4, 5 and 6 weights
- Tolerance checking or verification of balances

## Styles Available:

- Grip-handle
- Cylindrical
- Leaf weight

## Features:

- Nominal value marked on weights
- Serial numbers may be stamped on weights (Class 2 to 4)
- Sealing cavity for adjusting material in 100 g or larger weights
- Density 7.84g/cm<sup>3</sup>

## Classes Available:

- ASTM Class 1 polished finish
- ASTM Class 2 to 4 satin finish
- ASTM Class 0-7 manufactured in accordance with ASTM E 617-13 specification and tolerances

## Product Configuration:

- Kits and sets - case or vial, weight and glove or appropriate lifting device



# Electronic Calibration - ASTM Metric Kits

TEST WEIGHTS

CLASS 1*			CLASS 2		CLASS 3		OPTIONAL	OPTIONAL	REPLACEMENT CASES	
Weight	Kit Part #	Kit Price	Kit Part #	Kit Price	Kit Part #	Kit Price	Calibration Report	Mass Value Certificate	Part #	Price
5 kg	12958	\$610.00	13076	\$490.00	13179	\$465.00	\$140.00	\$75.00	11462	\$42.00
4 kg	12956	540.00	13074	485.00	13177	445.00	140.00	75.00	11463	42.00
3 kg	12954	325.00	13072	260.00	13175	250.00	140.00	75.00	11464	42.00
2 kg	12952	190.00	13070	170.00	13173	170.00	140.00	75.00	11465	42.00
1,500g	12985	170.00	13103	170.00	13206	165.00	140.00	75.00	11467	42.00
1,000g	12971	155.00	13089	140.00	13192	140.00	120.00	55.00	11468	42.00
600g	12983	150.00	13101	140.00	13204	140.00	120.00	55.00	11469	42.00
500g	12950	130.00	13068	130.00	13171	115.00	120.00	55.00	11470	42.00
400g	12968	130.00	13086	125.00	13189	120.00	120.00	55.00	11471	42.00
300g	12966	120.00	13084	120.00	13187	105.00	120.00	55.00	11472	42.00
200g	12948	105.00	13066	105.00	13169	105.00	120.00	55.00	11473	42.00
160g	12981	105.00	13099	105.00	13202	100.00	120.00	55.00	11474	42.00
150g	12979	100.00	13097	95.00	13200	90.00	120.00	55.00	11475	42.00
100g	12946	90.00	13064	85.00	13167	85.00	50.00	40.00	11476	42.00
50g	12964	80.00	13082	75.00	13185	75.00	50.00	40.00	11480	42.00
30g	12962	80.00	13080	75.00	13183	75.00	50.00	40.00	11481	42.00
20g	12960	80.00	13078	75.00	13181	75.00	50.00	40.00	11482	42.00
10g	12944	80.00	13062	75.00	13165	75.00	50.00	40.00	11483	42.00

\*Polished finish

CLASS 4			OPTIONAL	REPLACEMENT CASES	
Weight	Kit Part #	Kit Price	Traceable Certificate	Part #	Price
5 kg	13282	\$450.00	\$70.00	11462	\$42.00
4 kg	13280	425.00	70.00	11463	42.00
3 kg	13278	245.00	70.00	11464	42.00
2 kg	13276	160.00	70.00	11465	42.00
1,500g	13309	155.00	70.00	11467	42.00
1,000g	13295	140.00	70.00	11468	42.00
600g	13307	138.00	50.00	11469	42.00
500g	13274	115.00	50.00	11470	42.00
400g	13292	110.00	50.00	11471	42.00
300g	13290	100.00	50.00	11472	42.00
200g	13272	95.00	50.00	11473	42.00
160g	13305	95.00	50.00	11474	42.00
150g	13303	85.00	35.00	11475	42.00
100g	13270	75.00	35.00	11476	42.00
50g	13288	75.00	35.00	11480	42.00
30g	13286	70.00	35.00	11481	42.00
20g	13284	70.00	35.00	11482	42.00
10g	13268	70.00	35.00	11483	42.00

### ADDITIONAL ACCESSORIES

Part #	Description	Price
36092	Statement of Accuracy	\$45.00
11714	Weight gloves, white cotton	5.00
11773	Vinyl glove	1.50
25836	Serial number	15.00



Kits

www.ricelake.com | Phone: 800-472-6703

RICELAKE



# Electronic Calibration - ASTM Metric Individual Weights

		CLASS 1* <i>*Polished finish</i>			CLASS 2		CLASS 3		OPTIONAL		OPTIONAL		REPLACEMENT CASES	
		Weight	Part #	Price	Part #	Price	Part #	Price	Calibration Report	Mass Value Certificate	Part #	Price	Part #	Price
Grip Handle		30 kg	<b>12996</b>	\$1,760.00	<b>13114</b>	\$1,555.00	<b>13217</b>	\$1,395.00	\$375.00	\$80.00	-	-	-	-
		25 kg	<b>12995</b>	1,520.00	<b>13113</b>	1,300.00	<b>13216</b>	1,210.00	140.00	75.00	-	-	-	-
		24 kg	<b>12994</b>	1,470.00	<b>13112</b>	1,280.00	<b>13215</b>	1,175.00	140.00	75.00	-	-	-	-
		20 kg	<b>12993</b>	1,335.00	<b>13111</b>	1,140.00	<b>13214</b>	1,035.00	140.00	75.00	-	-	-	-
		16 kg	<b>12992</b>	1,175.00	<b>13110</b>	1,100.00	<b>13213</b>	885.00	140.00	75.00	-	-	-	-
		10 kg	<b>12991</b>	850.00	<b>13109</b>	770.00	<b>13212</b>	700.00	140.00	75.00	-	-	-	-
		8 kg	<b>12990</b>	830.00	<b>13108</b>	755.00	<b>13211</b>	650.00	140.00	75.00	-	-	-	-
Cylindrical		5 kg	<b>12989</b>	620.00	<b>13107</b>	500.00	<b>13210</b>	485.00	140.00	75.00	-	-	-	-
		5 kg	<b>12959</b>	585.00	<b>13077</b>	470.00	<b>13180</b>	445.00	140.00	75.00	<b>11462</b>	\$42.00	<b>11462</b>	\$42.00
		4 kg	<b>12957</b>	515.00	<b>13075</b>	460.00	<b>13178</b>	420.00	140.00	75.00	<b>11463</b>	42.00	<b>11463</b>	42.00
		3 kg	<b>12955</b>	305.00	<b>13073</b>	240.00	<b>13176</b>	230.00	140.00	75.00	<b>11464</b>	42.00	<b>11464</b>	42.00
		2 kg	<b>12953</b>	170.00	<b>13071</b>	155.00	<b>13174</b>	145.00	140.00	75.00	<b>11465</b>	42.00	<b>11465</b>	42.00
		1,500g	<b>12986</b>	150.00	<b>13104</b>	150.00	<b>13207</b>	145.00	140.00	75.00	<b>11467</b>	42.00	<b>11467</b>	42.00
		1,000g	<b>12972</b>	130.00	<b>13090</b>	125.00	<b>13193</b>	120.00	120.00	55.00	<b>11468</b>	42.00	<b>11468</b>	42.00
		600g	<b>12984</b>	125.00	<b>13102</b>	120.00	<b>13205</b>	120.00	120.00	55.00	<b>11469</b>	42.00	<b>11469</b>	42.00
		500g	<b>12951</b>	110.00	<b>13069</b>	105.00	<b>13172</b>	95.00	120.00	55.00	<b>11470</b>	42.00	<b>11470</b>	42.00
		400g	<b>12969</b>	105.00	<b>13087</b>	100.00	<b>13190</b>	95.00	120.00	55.00	<b>11471</b>	42.00	<b>11471</b>	42.00
		300g	<b>12967</b>	100.00	<b>13085</b>	90.00	<b>13188</b>	85.00	120.00	55.00	<b>11472</b>	42.00	<b>11472</b>	42.00
		200g	<b>12949</b>	90.00	<b>13067</b>	90.00	<b>13170</b>	80.00	120.00	55.00	<b>11473</b>	42.00	<b>11473</b>	42.00
		160g	<b>12982</b>	90.00	<b>13100</b>	90.00	<b>13203</b>	80.00	120.00	55.00	<b>11474</b>	42.00	<b>11474</b>	42.00
		150g	<b>12980</b>	75.00	<b>13098</b>	70.00	<b>13201</b>	65.00	120.00	55.00	<b>11475</b>	42.00	<b>11475</b>	42.00
		100g	<b>12947</b>	70.00	<b>13065</b>	65.00	<b>13168</b>	60.00	50.00	40.00	<b>11476</b>	42.00	<b>11476</b>	42.00
		50g	<b>12965</b>	65.00	<b>13083</b>	60.00	<b>13186</b>	55.00	50.00	40.00	<b>11480</b>	42.00	<b>11480</b>	42.00
		30g	<b>12963</b>	65.00	<b>13081</b>	60.00	<b>13184</b>	55.00	50.00	40.00	<b>11481</b>	42.00	<b>11481</b>	42.00
		20g	<b>12961</b>	65.00	<b>13079</b>	60.00	<b>13182</b>	55.00	50.00	40.00	<b>11482</b>	42.00	<b>11482</b>	42.00
		10g	<b>12945</b>	65.00	<b>13063</b>	60.00	<b>13166</b>	55.00	50.00	40.00	<b>11483</b>	42.00	<b>11483</b>	42.00

		CLASS 4			OPTIONAL		REPLACEMENT CASES		
		Weight	Part #	Price	Traceable Certificate	Part #	Price	Part #	Price
Grip Handle		30 kg	<b>13320</b>	\$1,295.00	\$75.00	-	-	-	-
		25 kg	<b>13319</b>	1,090.00	70.00	-	-	-	-
		24 kg	<b>13318</b>	1,040.00	70.00	-	-	-	-
		20 kg	<b>13317</b>	890.00	70.00	-	-	-	-
		16 kg	<b>13316</b>	790.00	70.00	-	-	-	-
		10 kg	<b>13315</b>	615.00	70.00	-	-	-	-
		8 kg	<b>13314</b>	610.00	70.00	-	-	-	-
Cylindrical		5 kg	<b>13313</b>	385.00	70.00	-	-	-	-
		5 kg	<b>13283</b>	430.00	70.00	<b>11462</b>	\$42.00	<b>11462</b>	\$42.00
		4 kg	<b>13281</b>	405.00	70.00	<b>11463</b>	42.00	<b>11463</b>	42.00
		3 kg	<b>13279</b>	225.00	70.00	<b>11464</b>	42.00	<b>11464</b>	42.00
		2 kg	<b>13277</b>	140.00	70.00	<b>11465</b>	42.00	<b>11465</b>	42.00
		1,500g	<b>13310</b>	135.00	70.00	<b>11467</b>	42.00	<b>11467</b>	42.00
		1,000g	<b>13296</b>	120.00	70.00	<b>11468</b>	42.00	<b>11468</b>	42.00
		600g	<b>13308</b>	120.00	50.00	<b>11469</b>	42.00	<b>11469</b>	42.00
		500g	<b>13275</b>	90.00	50.00	<b>11470</b>	42.00	<b>11470</b>	42.00
		400g	<b>13293</b>	90.00	50.00	<b>11471</b>	42.00	<b>11471</b>	42.00
		300g	<b>13291</b>	80.00	50.00	<b>11472</b>	42.00	<b>11472</b>	42.00
		200g	<b>13273</b>	75.00	50.00	<b>11473</b>	42.00	<b>11473</b>	42.00
		160g	<b>13306</b>	75.00	50.00	<b>11474</b>	42.00	<b>11474</b>	42.00
	150g	<b>13304</b>	60.00	35.00	<b>11475</b>	42.00	<b>11475</b>	42.00	
	100g	<b>13271</b>	55.00	35.00	<b>11476</b>	42.00	<b>11476</b>	42.00	
	50g	<b>13289</b>	55.00	35.00	<b>11480</b>	42.00	<b>11480</b>	42.00	
	30g	<b>13287</b>	55.00	35.00	<b>11481</b>	42.00	<b>11481</b>	42.00	
	20g	<b>13285</b>	55.00	35.00	<b>11482</b>	42.00	<b>11482</b>	42.00	
	10g	<b>13269</b>	55.00	35.00	<b>11483</b>	42.00	<b>11483</b>	42.00	



Individual

# Electronic Calibration - ASTM Avoirdupois Kits

TEST WEIGHTS

CLASS 1*			CLASS 2		CLASS 3		OPTIONAL	OPTIONAL	REPLACEMENT CASES	
Weight	Kit Part #	Kit Price	Kit Part #	Kit Price	Kit Part #	Kit Price	Calibration Report	Mass Value Certificate	Part #	Price
10lb	13021	\$610.00	13138	\$490.00	13241	\$440.00	\$125.00	\$80.00	152299	\$42.00
5lb	13019	325.00	13136	260.00	13239	260.00	125.00	80.00	11496	42.00
4lb	13017	190.00	13134	185.00	13237	185.00	125.00	80.00	11465	42.00
3lb	13015	170.00	13132	170.00	13235	170.00	125.00	80.00	11495	42.00
2lb	13013	155.00	13130	140.00	13233	140.00	100.00	65.00	11468	42.00
1 lb	13011	130.00	13128	130.00	13231	120.00	100.00	65.00	82983	42.00
8 oz	13009	110.00	13126	105.00	13229	105.00	50.00	40.00	11491	42.00
4 oz	13007	105.00	13124	85.00	13227	85.00	50.00	40.00	11494	42.00
2 oz	13005	100.00	13122	85.00	13225	85.00	50.00	40.00	11479	42.00
1 oz	13003	100.00	13120	85.00	13223	85.00	50.00	40.00	11493	42.00
1/2 oz	13001	100.00	13118	85.00	13221	85.00	50.00	40.00	11492	42.00
0.5lb	13032	110.00	13149	105.00	13252	105.00	50.00	40.00	11491	42.00
0.2lb	13024	105.00	13141	85.00	13244	80.00	50.00	40.00	11479	42.00
0.1 lb	13026	100.00	13143	85.00	13246	80.00	50.00	40.00	11478	42.00
0.05lb	13028	100.00	13145	85.00	13248	80.00	50.00	40.00	82982	42.00

\* Polished finish

CLASS 4			OPTIONAL	REPLACEMENT CASES	
Weight	Kit Part #	Kit Price	Traceable Certificate	Part #	Price
10lb	13344	\$425.00	\$75.00	11462	\$42.00
5lb	13342	250.00	75.00	11496	42.00
4lb	13340	175.00	75.00	11465	42.00
3lb	13338	160.00	75.00	11495	42.00
2lb	13336	140.00	60.00	11468	42.00
1 lb	13334	115.00	60.00	82983	42.00
8 oz	13332	95.00	35.00	11491	42.00
4 oz	13330	85.00	35.00	11494	42.00
2 oz	13328	85.00	35.00	11479	42.00
1 oz	13326	80.00	35.00	11493	42.00
1/2 oz	13324	80.00	35.00	11492	42.00
0.5lb	13355	100.00	35.00	11491	42.00
0.2lb	13347	75.00	35.00	11479	42.00
0.1 lb	13349	75.00	35.00	11478	42.00
0.05lb	13351	75.00	35.00	82982	42.00

### ADDITIONAL ACCESSORIES

Part #	Description	Price
36092	Statement of Accuracy	\$45.00
11714	Weight gloves, white cotton	5.00
11773	Vinyl glove	1.50
25836	Serial number	15.00



Kits

www.ricelake.com | Phone: 800-472-6703

RICELAKE

# Electronic Calibration - ASTM

## Avoirdupois Individual Weights

		CLASS 1*			CLASS 2		CLASS 3		OPTIONAL		OPTIONAL		REPLACEMENT CASES	
		Weight	Part #	Price	Part #	Price	Part #	Price	Calibration Report	Mass Value Certificate	Part #	Price	Part #	Price
Grip Handle	50lb	<b>13038</b>		\$1,520.00	<b>13155</b>	\$1,300.00	<b>13258</b>	\$1,215.00	\$275.00	\$80.00	-	-	-	-
	30lb	<b>13037</b>		1,180.00	<b>13154</b>	960.00	<b>13257</b>	850.00	125.00	80.00	-	-	-	-
	25lb	<b>13036</b>		850.00	<b>13153</b>	745.00	<b>13256</b>	645.00	125.00	80.00	-	-	-	-
	20lb	<b>13035</b>		845.00	<b>13152</b>	720.00	<b>13255</b>	625.00	125.00	80.00	-	-	-	-
	10lb	<b>13034</b>		620.00	<b>13151</b>	500.00	<b>13254</b>	490.00	125.00	80.00	-	-	-	-
Cylindrical	10lb	<b>13022</b>		590.00	<b>13139</b>	465.00	<b>13242</b>	420.00	125.00	80.00	<b>11462</b>	\$42.00		
	5lb	<b>13020</b>		305.00	<b>13137</b>	250.00	<b>13240</b>	240.00	125.00	80.00	<b>11496</b>	42.00		
	4lb	<b>13018</b>		170.00	<b>13135</b>	160.00	<b>13238</b>	155.00	125.00	80.00	<b>11465</b>	42.00		
	3lb	<b>13016</b>		150.00	<b>13133</b>	145.00	<b>13236</b>	145.00	125.00	80.00	<b>11495</b>	42.00		
	2lb	<b>13014</b>		135.00	<b>13131</b>	125.00	<b>13234</b>	120.00	100.00	65.00	<b>11468</b>	42.00		
	1lb	<b>13012</b>		110.00	<b>13129</b>	105.00	<b>13232</b>	100.00	100.00	65.00	<b>82983</b>	42.00		
	8oz	<b>13010</b>		90.00	<b>13127</b>	85.00	<b>13230</b>	80.00	50.00	40.00	<b>11491</b>	42.00		
	4oz	<b>13008</b>		85.00	<b>13125</b>	70.00	<b>13228</b>	70.00	50.00	40.00	<b>11494</b>	42.00		
	2oz	<b>13006</b>		80.00	<b>13123</b>	65.00	<b>13226</b>	65.00	50.00	40.00	<b>11479</b>	42.00		
	1oz	<b>13004</b>		80.00	<b>13121</b>	65.00	<b>13224</b>	60.00	50.00	40.00	<b>11493</b>	42.00		
	1/2oz	<b>13002</b>		75.00	<b>13119</b>	65.00	<b>13222</b>	60.00	50.00	40.00	<b>11492</b>	42.00		
	0.5lb	<b>13033</b>		90.00	<b>13150</b>	80.00	<b>13253</b>	80.00	50.00	40.00	<b>11491</b>	42.00		
	0.2lb	<b>13025</b>		85.00	<b>13142</b>	65.00	<b>13245</b>	55.00	50.00	40.00	<b>11479</b>	42.00		
	0.1lb	<b>13027</b>		80.00	<b>13144</b>	65.00	<b>13247</b>	55.00	50.00	40.00	<b>11478</b>	42.00		
	0.05lb	<b>13029</b>		75.00	<b>13146</b>	65.00	<b>13249</b>	55.00	50.00	40.00	<b>82982</b>	42.00		

		CLASS 4			OPTIONAL		REPLACEMENT CASES	
		Weight	Part #	Price	Traceable Certificate	Part #	Price	
Grip Handle	50lb	<b>13361</b>		\$1205.00	\$75.00	-	-	
	30lb	<b>13360</b>		800.00	75.00	-	-	
	25lb	<b>13359</b>		585.00	75.00	-	-	
	20lb	<b>13358</b>		525.00	75.00	-	-	
	10lb	<b>13357</b>		400.00	75.00	-	-	
Cylindrical	10lb	<b>13345</b>		400.00	75.00	<b>11462</b>	\$42.00	
	5lb	<b>13343</b>		230.00	75.00	<b>11496</b>	42.00	
	4lb	<b>13341</b>		150.00	75.00	<b>11465</b>	42.00	
	3lb	<b>13339</b>		140.00	75.00	<b>11495</b>	42.00	
	2lb	<b>13337</b>		120.00	60.00	<b>11468</b>	42.00	
	1lb	<b>13335</b>		95.00	60.00	<b>82983</b>	42.00	
	8oz	<b>13333</b>		75.00	35.00	<b>11491</b>	42.00	
	4oz	<b>13331</b>		65.00	35.00	<b>11494</b>	42.00	
	2oz	<b>13329</b>		60.00	35.00	<b>11479</b>	42.00	
	1oz	<b>13327</b>		55.00	35.00	<b>11493</b>	42.00	
	1/2oz	<b>13325</b>		55.00	35.00	<b>11492</b>	42.00	
	0.5lb	<b>13356</b>		75.00	35.00	<b>11491</b>	42.00	
	0.2lb	<b>13348</b>		55.00	35.00	<b>11479</b>	42.00	
	0.1lb	<b>13350</b>		55.00	35.00	<b>11478</b>	42.00	
	0.05lb	<b>13352</b>		55.00	35.00	<b>82982</b>	42.00	

\*Polished finish



Individual

TEST WEIGHTS

www.ricelake.com | Phone: 800-472-6703

RICE LAKE

853

## PRECISION LABORATORY - ASTM

### Applications

- Calibrating Class I & II balances
- ASTM Class 4, 5 and 6 weights
- Student laboratory use
- Rough weighing operations: i.e., force
- Tolerance testing
- Verification checks

### Styles Available:

- Type II design (screw knob) with sealing cavity for adjusting material (Classes 1-4)
- Type I design (one piece) for Class 0

### Features:

- Stainless steel polished finish
- Designed to meet ASTM E617-13 specifications
- ASTM Class 0 weight sets and individual weights are not individually marked with their weight value or individually serialized per ASTM E 617-13
- Nominal value marked on weights
- Serial numbers applied to case (weights may be marked with symbol)
- Density 7.95g/cm<sup>3</sup>

### Product Configuration:

- Kits – case or vial, weight and glove
- Individual weights for custom sets
- Weight sets configurations: 5-2-2-1 and 5-3-2-1  
Example: 50, (2) 20, 10 or 50, 30, 20, 10

### Custom Configuration:

- Custom sets are available as build to order to meet your specific requirements.
- ASTM weights sets larger than 500g or 1 lb include a hardwood case with velvet-lined pockets
- Weight sets with the largest weight of 500g include a precision-machined polyvinyl, crush resistant case



Precision Laboratory - ASTM  
Metric Kits

CLASS 0\* ONE PIECE DESIGN

REPLACEMENT CASES

	Weight	Kit Part #	Kit Price	Part #	Price
<b>Cylindrical</b>	50 kg	Consult	Consult	Consult	Consult
	25 kg	Consult	Consult	Consult	Consult
	20 kg	45856	\$3,615.00	Consult	Consult
	10 kg	45857	2,370.00	Consult	Consult
	5 kg	45858	1,700.00	Consult	Consult
	3 kg	45859	1,500.00	Consult	Consult
	2 kg	45860	1,230.00	Consult	Consult
	1 kg	45861	910.00	Consult	Consult
	500 g	45862	555.00	Consult	Consult
	300 g	45863	525.00	Consult	Consult
	200 g	45864	485.00	Consult	Consult
	100 g	45865	405.00	Consult	Consult
	50 g	45866	380.00	Consult	Consult
	30 g	45867	370.00	Consult	Consult
	20 g	45868	370.00	Consult	Consult
10 g	45869	370.00	Consult	Consult	
5 g	45870	320.00	Consult	Consult	
3 g	45871	320.00	Consult	Consult	
2 g	45872	320.00	Consult	Consult	
1 g	45873	320.00	Consult	Consult	
<b>Milligram</b>	500 mg	45874	246.00	-	-
	300 mg	45875	246.00	-	-
	200 mg	45876	246.00	-	-
	100 mg	45877	246.00	-	-
	50 mg	45878	246.00	-	-
	30 mg	45879	246.00	-	-
	20 mg	45880	246.00	-	-
	10 mg	45881	246.00	-	-
	5 mg	45882	246.00	-	-
	3 mg	45883	246.00	-	-
2 mg	45884	246.00	-	-	
1 mg	45885	246.00	-	-	



One-piece and Milligram Kits

\*Calibration Report is included, Statement of Accuracy is not available for Class 0 and require case for shipping.

ADDITIONAL ACCESSORIES

Part #	Description	Price
11711	Weight tweezer (plastic) for polished weights 100g and below	\$3.00
152414	Premium tweezer	35.00
11714	Weight gloves, white, cotton	5.00
11755	Leaf weight lid	35.00
11747	Weight lifter bar, plexiglas, for weights 200 g - 3 kg and 8 oz - 5 lb (screw knob weights only)	15.00
11712	Lifter with larger handle (Class 1-4/4 kg - 25 kg) (10 lb/50 lb)	60.00
50035	Weight forceps, plastic, Class 0, 100 g - 1 mg	35.00
50000	Tong assembly, Class 0, 1 kg x 200 g	60.00



One Piece Kit

Precision Laboratory - ASTM  
**Metric Individual Weights**

TEST WEIGHTS

www.ricelake.com | Phone: 800-472-6703

**RICE LAKE**

**CLASS 0\* ONE PIECE DESIGN**

**REPLACEMENT CASES**

	Weight	Part #	Price	Part #	Price
<b>Cylindrical</b>	50 kg	Consult	Consult	Consult	Consult
	25 kg	Consult	Consult	Consult	Consult
	20 kg	<b>46097</b>	\$3,555.00	Consult	Consult
	10 kg	<b>46096</b>	2,320.00	Consult	Consult
	5 kg	<b>46095</b>	1,650.00	Consult	Consult
	3 kg	<b>46094</b>	1,480.00	Consult	Consult
	2 kg	<b>46093</b>	1,210.00	Consult	Consult
	1 kg	<b>46092</b>	890.00	Consult	Consult
	500 g	<b>46091</b>	540.00	Consult	Consult
	300 g	<b>46090</b>	510.00	Consult	Consult
	200 g	<b>46089</b>	470.00	Consult	Consult
	100 g	<b>46088</b>	390.00	Consult	Consult
	50 g	<b>46087</b>	365.00	Consult	Consult
	30 g	<b>46086</b>	355.00	Consult	Consult
	20 g	<b>46085</b>	355.00	Consult	Consult
	10 g	<b>46084</b>	355.00	Consult	Consult
	5 g	<b>46083</b>	305.00	Consult	Consult
	3 g	<b>46082</b>	305.00	Consult	Consult
	2 g	<b>46081</b>	305.00	Consult	Consult
1 g	<b>46080</b>	305.00	Consult	Consult	
<b>Milligram</b>	500 mg	<b>46079</b>	245.00	-	-
	300 mg	<b>46078</b>	245.00	-	-
	200 mg	<b>46077</b>	245.00	-	-
	100 mg	<b>46076</b>	245.00	-	-
	50 mg	<b>46075</b>	245.00	-	-
	30 mg	<b>46074</b>	245.00	-	-
	20 mg	<b>46073</b>	245.00	-	-
	10 mg	<b>46072</b>	245.00	-	-
	5 mg	<b>46071</b>	245.00	-	-
	3 mg	<b>46070</b>	245.00	-	-
	2 mg	<b>46069</b>	245.00	-	-
1 mg	<b>46068</b>	245.00	-	-	

\*Calibration Report is included, Statement of Accuracy is not available for Class 0 and require case for shipping.  
 For special kits, individual weights must ship in a case.



One Piece

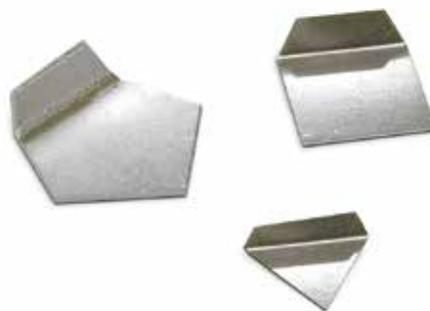

Milligram

# Precision Laboratory - ASTM Metric Kits

	CLASS 1			CLASS 2		CLASS 3		OPTIONAL		OPTIONAL		REPLACEMENT CASES	
	Weight	Kit Part #	Kit Price	Kit Part #	Kit Price	Kit Part #	Kit Price	Calibration Report	Mass Value Certificate	Part #	Price		
<b>Screw Knob</b>	50 kg	Consult	Consult	Consult	Consult	Consult	Consult	Consult	Consult	Consult	Consult		
	25 kg	Consult	Consult	Consult	Consult	Consult	Consult	Consult	Consult	Consult	Consult		
	20 kg	<b>82590</b>	\$3,220.00	<b>82632</b>	\$2,165.00	<b>82674</b>	\$2,140.00	\$140.00	\$75.00	<b>80703</b>	\$200.00		
	10 kg	<b>82591</b>	1,830.00	<b>82633</b>	1,755.00	<b>82675</b>	1,610.00	140.00	75.00	<b>80704</b>	200.00		
	5 kg	<b>82592</b>	1,055.00	<b>82634</b>	1,020.00	<b>82676</b>	1,015.00	140.00	75.00	<b>80705</b>	145.00		
	3 kg	<b>82593</b>	835.00	<b>82635</b>	800.00	<b>82677</b>	775.00	140.00	75.00	<b>80706</b>	42.00		
	2 kg	<b>82594</b>	660.00	<b>82636</b>	620.00	<b>82678</b>	610.00	140.00	75.00	<b>80707</b>	42.00		
	1 kg	<b>82595</b>	475.00	<b>82637</b>	410.00	<b>82679</b>	400.00	120.00	55.00	<b>80708</b>	42.00		
	500 g	<b>82596</b>	200.00	<b>82638</b>	195.00	<b>82680</b>	190.00	120.00	55.00	<b>80709</b>	30.00		
	300 g	<b>82597</b>	155.00	<b>82639</b>	145.00	<b>82681</b>	140.00	120.00	55.00	<b>80710</b>	30.00		
	200 g	<b>82598</b>	145.00	<b>82640</b>	140.00	<b>82682</b>	135.00	120.00	55.00	<b>80711</b>	30.00		
	100 g	<b>82599</b>	105.00	<b>82641</b>	105.00	<b>82683</b>	100.00	50.00	40.00	<b>80712</b>	30.00		
	50 g	<b>82600</b>	100.00	<b>82642</b>	95.00	<b>82684</b>	90.00	50.00	40.00	<b>80713</b>	30.00		
	30 g	<b>82601</b>	95.00	<b>82643</b>	85.00	<b>82685</b>	85.00	50.00	40.00	<b>80714</b>	30.00		
	20 g	<b>82602</b>	90.00	<b>82644</b>	80.00	<b>82686</b>	80.00	50.00	40.00	<b>80715</b>	30.00		
	10 g	<b>82603</b>	90.00	<b>82645</b>	80.00	<b>82687</b>	80.00	50.00	40.00	<b>80716</b>	30.00		
	5 g	<b>82604</b>	90.00	<b>82646</b>	70.00	<b>82688</b>	60.00	50.00	40.00	<b>80717</b>	30.00		
	3 g	<b>82605</b>	80.00	<b>82647</b>	70.00	<b>82689</b>	60.00	50.00	40.00	<b>80718</b>	30.00		
	2 g	<b>82606</b>	80.00	<b>82648</b>	70.00	<b>82690</b>	60.00	50.00	40.00	<b>80719</b>	30.00		
	1 g	<b>82607</b>	70.00	<b>82649</b>	70.00	<b>82691</b>	60.00	50.00	40.00	<b>80720</b>	30.00		
<b>Milligram</b>	500 mg	<b>80458</b>	60.00	<b>80470</b>	40.00	<b>80482</b>	35.00	50.00	40.00	-	-		
	300 mg	<b>80459</b>	60.00	<b>80471</b>	40.00	<b>80483</b>	35.00	50.00	40.00	-	-		
	200 mg	<b>80460</b>	60.00	<b>80472</b>	40.00	<b>80484</b>	35.00	50.00	40.00	-	-		
	100 mg	<b>80461</b>	60.00	<b>80473</b>	40.00	<b>80485</b>	35.00	50.00	40.00	-	-		
	50 mg	<b>80462</b>	60.00	<b>80474</b>	40.00	<b>80486</b>	35.00	50.00	40.00	-	-		
	30 mg	<b>80463</b>	60.00	<b>80475</b>	40.00	<b>80487</b>	35.00	50.00	40.00	-	-		
	20 mg	<b>80464</b>	60.00	<b>80476</b>	40.00	<b>80488</b>	35.00	50.00	40.00	-	-		
	10 mg	<b>80465</b>	60.00	<b>80477</b>	40.00	<b>80489</b>	35.00	50.00	40.00	-	-		
	5 mg	<b>80466</b>	60.00	<b>80478</b>	40.00	<b>80490</b>	35.00	50.00	40.00	-	-		
	3 mg	<b>80467</b>	60.00	<b>80479</b>	40.00	<b>80491</b>	35.00	50.00	40.00	-	-		
	2 mg	<b>80468</b>	60.00	<b>80480</b>	40.00	<b>80492</b>	35.00	50.00	40.00	-	-		
	1 mg	<b>80469</b>	60.00	<b>80481</b>	40.00	<b>80493</b>	35.00	50.00	40.00	-	-		
	0.5 mg	<b>36076*</b>	60.00	<b>36077</b>	40.00	<b>36078</b>	35.00	50.00	40.00	-	-		

\* Wire weight

## ADDITIONAL ACCESSORIES

Part #	Description	Price
<b>11711</b>	Weight tweezer, plastic, for polished weights 100 g and below	\$3.00
<b>152414</b>	Premium tweezer	35.00
<b>11714</b>	Weight gloves, white, cotton	5.00
<b>11755</b>	Leaf weight lid	35.00
<b>11747</b>	Weight lifter bar, plexiglass, for weights 200 g - 3 kg and 8 oz - 5 lb (screw knob weights only)	15.00
<b>11712</b>	Lifter with larger handle (Class 1-4/4 kg - 25 kg) (10 lb/50 lb)	60.00
<b>36092</b>	Statement of Accuracy	45.00
<b>25836</b>	Serial number	15.00



Screw-knob Kit

TEST WEIGHTS

www.ricelake.com | Phone: 800-472-6703

RICE LAKE

Precision Laboratory - ASTM  
**Metric Individual Weights**

TEST WEIGHTS

	CLASS 1			CLASS 2		CLASS 3		OPTIONAL	OPTIONAL	REPLACEMENT CASES	
	Weight	Part #	Price	Part #	Price	Part #	Price	Calibration Report	Mass Value Certificate	Part #	Price
<b>Screw Knob</b>	50 kg	Consult	Consult	Consult	Consult	12274	Consult	Consult	Consult	Consult	Consult
	25 kg	11876	\$3,800.00	12131	\$3,555.00	12272	\$3,495.00	Consult	Consult	Consult	Consult
	20 kg	11875	3,110.00	12130	2,055.00	12271	2,025.00	\$140.00	\$75.00	80703	\$200.00
	10 kg	11874	1,725.00	12129	1,610.00	12270	1,500.00	140.00	75.00	80704	200.00
	5 kg	11872	945.00	12127	940.00	12269	935.00	140.00	75.00	80705	145.00
	3 kg	11871	810.00	12126	780.00	12268	750.00	140.00	75.00	80706	40.00
	2 kg	11870	640.00	12125	600.00	12267	590.00	140.00	75.00	80707	42.00
	1 kg	11869	445.00	12124	400.00	12266	385.00	120.00	55.00	80708	42.00
	500 g	11867	185.00	12122	180.00	12265	175.00	120.00	55.00	80709	30.00
	300 g	11866	140.00	12121	130.00	12264	125.00	120.00	55.00	80710	30.00
	200 g	11865	130.00	12120	125.00	12263	120.00	120.00	55.00	80711	30.00
	100 g	11864	95.00	12119	90.00	12262	85.00	50.00	40.00	80712	30.00
	50 g	11862	90.00	12117	75.00	12261	75.00	50.00	40.00	80713	30.00
	30 g	11861	85.00	12116	70.00	12260	70.00	50.00	40.00	80714	30.00
	20 g	11860	85.00	12115	70.00	12259	70.00	50.00	40.00	80715	30.00
	10 g	11859	80.00	12114	70.00	12258	70.00	50.00	40.00	80716	30.00
	5 g	11857	75.00	12112	55.00	12257	52.00	50.00	40.00	80717	30.00
	3 g	11856	65.00	12111	55.00	12256	52.00	50.00	40.00	80718	30.00
	2 g	11855	65.00	12110	55.00	12255	52.00	50.00	40.00	80719	30.00
	1 g	11854	60.00	12109	55.00	12254	52.00	50.00	40.00	80720	30.00
<b>Milligram</b>	500 mg	11852	55.00	12107	35.00	12253	32.00	50.00	40.00	-	-
	300 mg	11851	55.00	12106	35.00	12252	32.00	50.00	40.00	-	-
	200 mg	11850	55.00	12105	35.00	12251	32.00	50.00	40.00	-	-
	100 mg	11849	55.00	12104	35.00	12250	32.00	50.00	40.00	-	-
	50 mg	11847	55.00	12102	35.00	12248	32.00	50.00	40.00	-	-
	30 mg	11846	55.00	12101	35.00	12247	32.00	50.00	40.00	-	-
	20 mg	11845	55.00	12100	35.00	12246	32.00	50.00	40.00	-	-
	10 mg	11844	55.00	12099	35.00	12245	32.00	50.00	40.00	-	-
	5 mg	11842	55.00	12097	35.00	12244	32.00	50.00	40.00	-	-
	3 mg	11841	55.00	12096	35.00	12243	32.00	50.00	40.00	-	-
	2 mg	11840	55.00	12095	35.00	12242	32.00	50.00	40.00	-	-
	1 mg	11839	55.00	12094	35.00	12241	32.00	50.00	40.00	-	-
0.5 mg*	N/A	N/A	-	-	-	-	50.00	40.00	-	-	

\*Wire Weight

For special kits, individual weights must ship in a case



Screw-knob Design



Milligram

www.ricelake.com | Phone: 800-472-6703

**RICE LAKE**



Precision Laboratory - ASTM  
Metric Kits

	CLASS 4			OPTIONAL	REPLACEMENT CASES	
	Weight	Kit Part #	Kit Price	Traceable Certificate	Part #	Price
<b>Screw Knob</b>	50kg	<b>Consult</b>	Consult	Consult	<b>Consult</b>	Consult
	25kg	<b>Consult</b>	Consult	Consult	<b>Consult</b>	Consult
	20kg	<b>82716</b>	\$2,000.00	\$70.00	<b>80703</b>	\$200.00
	10kg	<b>82717</b>	1,445.00	70.00	<b>80704</b>	200.00
	5kg	<b>82718</b>	1,000.00	70.00	<b>80705</b>	145.00
	3kg	<b>82719</b>	725.00	70.00	<b>80706</b>	40.00
	2kg	<b>82720</b>	585.00	70.00	<b>80707</b>	42.00
	1kg	<b>82721</b>	385.00	50.00	<b>80708</b>	42.00
	500g	<b>82722</b>	185.00	50.00	<b>80709</b>	30.00
	300g	<b>82723</b>	135.00	50.00	<b>80710</b>	30.00
	200g	<b>82724</b>	115.00	50.00	<b>80711</b>	30.00
	100g	<b>82725</b>	80.00	35.00	<b>80712</b>	30.00
	50g	<b>82726</b>	80.00	35.00	<b>80713</b>	30.00
	30g	<b>82727</b>	70.00	35.00	<b>80714</b>	30.00
	20g	<b>82728</b>	70.00	35.00	<b>80715</b>	30.00
	10g	<b>82729</b>	65.00	35.00	<b>80716</b>	30.00
	5g	<b>82730</b>	50.00	35.00	<b>80717</b>	30.00
	3g	<b>82731</b>	50.00	35.00	<b>80718</b>	30.00
	2g	<b>82732</b>	50.00	35.00	<b>80719</b>	30.00
	1g	<b>82733</b>	50.00	35.00	<b>80720</b>	30.00
<b>Milligram</b>	500mg	<b>80494</b>	30.00	35.00	-	-
	300mg	<b>80495</b>	30.00	35.00	-	-
	200mg	<b>80496</b>	30.00	35.00	-	-
	100mg	<b>80497</b>	30.00	35.00	-	-
	50mg	<b>80498</b>	30.00	35.00	-	-
	30mg	<b>80499</b>	30.00	35.00	-	-
	20mg	<b>80500</b>	30.00	35.00	-	-
	10mg	<b>80501</b>	30.00	35.00	-	-
	5mg	<b>80502</b>	30.00	35.00	-	-
	3mg	<b>80503</b>	30.00	35.00	-	-
	2mg	<b>80504</b>	30.00	35.00	-	-
	1mg	<b>80505</b>	30.00	35.00	-	-
	0.5mg	<b>36079</b>	35.00	35.00	-	-

**ADDITIONAL ACCESSORIES**

Part #	Description	Price
<b>11711</b>	Weight tweezer (plastic) for polished weights 100 g and below	\$3.00
<b>152414</b>	Premium tweezer	35.00
<b>11714</b>	Weight gloves, white, cotton	5.00
<b>11755</b>	Leaf weight lid	35.00
<b>11747</b>	Weight lifter bar, plexiglas, for weights 200 g - 3 kg and 8 oz - 5 lb (screw knob weights only)	15.00
<b>11712</b>	Lifter with larger handle (Class 1-4/4 kg - 25 kg) (10 lb/50 lb)	60.00
<b>36092</b>	Statement of Accuracy	45.00
<b>25836</b>	Serial number	15.00



Precision Laboratory - ASTM  
**Metric Individual Weights**

TEST WEIGHTS

CLASS 4			OPTIONAL	REPLACEMENT CASES	
Weight	Part #	Price	Traceable Certificate	Part #	Price
50 kg	Consult	Consult	Consult	Consult	Consult
25 kg	12375	\$3,425.00	Consult	Consult	Consult
20 kg	12374	1,890.00	\$70.00	80703	\$200.00
10 kg	12373	1,335.00	70.00	80704	200.00
5 kg	12372	890.00	70.00	80705	145.00
3 kg	12371	700.00	70.00	80706	42.00
2 kg	12370	565.00	70.00	80707	42.00
1 kg	12369	370.00	50.00	80708	42.00
500 g	12368	170.00	50.00	80709	30.00
300 g	12367	120.00	50.00	80710	30.00
200 g	12366	105.00	50.00	80711	30.00
100 g	12365	75.00	35.00	80712	30.00
50 g	12364	62.00	35.00	80713	30.00
30 g	12363	55.00	35.00	80714	30.00
20 g	12362	55.00	35.00	80715	30.00
10 g	12361	55.00	35.00	80716	30.00
5 g	12360	40.00	35.00	80717	30.00
3 g	12359	40.00	35.00	80718	30.00
2 g	12358	40.00	35.00	80719	30.00
1 g	12357	40.00	35.00	80720	30.00
500 mg	12356	30.00	35.00	-	-
300 mg	12355	30.00	35.00	-	-
200 mg	12354	30.00	35.00	-	-
100 mg	12353	30.00	35.00	-	-
50 mg	12352	30.00	35.00	-	-
30 mg	12351	30.00	35.00	-	-
20 mg	12350	30.00	35.00	-	-
10 mg	22198	30.00	35.00	-	-
5 mg	22197	30.00	35.00	-	-
3 mg	22196	30.00	35.00	-	-
2 mg	22195	30.00	35.00	-	-
1 mg	22194	30.00	35.00	-	-

For special kits, individual weights must ship in a case



Screw-knob Design



Milligram

www.ricelake.com | Phone: 800-472-6703

**RICE LAKE**

Precision Laboratory - ASTM  
**Avoirdupois Kits**

	CLASS 1			CLASS 2		CLASS 3		OPTIONAL		OPTIONAL		REPLACEMENT CASES	
	Weight	Kit Part #	Kit Price	Kit Part #	Kit Price	Kit Part #	Kit Price	Calibration Report	Mass Value Certificate	Part #	Price		
<b>Screw Knob</b>	30lb	<b>82581</b>	\$3,345.00	<b>82625</b>	\$3,260.00	<b>82667</b>	\$3,140.00	\$125.00	\$80.00	<b>80743</b>	\$200.00		
	25lb	<b>82580</b>	2,325.00	<b>82624</b>	2,770.00	<b>82666</b>	2,665.00	125.00	80.00	<b>80742</b>	200.00		
	20lb	<b>82579</b>	2,300.00	<b>82623</b>	2,240.00	<b>82665</b>	2,100.00	125.00	80.00	<b>80741</b>	200.00		
	10lb	<b>82578</b>	1,350.00	<b>82622</b>	1,320.00	<b>82664</b>	1,250.00	125.00	80.00	<b>80740</b>	200.00		
	5lb	<b>82589</b>	970.00	<b>82631</b>	930.00	<b>82673</b>	910.00	125.00	80.00	<b>80739</b>	55.00		
	4lb	<b>82588</b>	825.00	<b>82630</b>	785.00	<b>82672</b>	755.00	125.00	80.00	<b>80738</b>	55.00		
	3lb	<b>82587</b>	620.00	<b>82629</b>	565.00	<b>82671</b>	550.00	125.00	80.00	<b>80737</b>	55.00		
	2lb	<b>82586</b>	545.00	<b>82628</b>	515.00	<b>82670</b>	495.00	100.00	65.00	<b>80736</b>	55.00		
	1lb	<b>82585</b>	275.00	<b>82627</b>	260.00	<b>82669</b>	245.00	100.00	65.00	<b>80735</b>	55.00		
	8 oz	<b>82584</b>	225.00	<b>82626</b>	215.00	<b>82668</b>	215.00	50.00	40.00	<b>80734</b>	30.00		
	0.5lb	<b>82570</b>	230.00	<b>82614</b>	215.00	<b>82656</b>	215.00	50.00	40.00	<b>80724</b>	30.00		
	0.3lb	<b>118518</b>	170.00	<b>118519</b>	165.00	<b>118520</b>	135.00	50.00	40.00	<b>118551</b>	30.00		
	0.2lb	<b>82569</b>	145.00	<b>82613</b>	145.00	<b>82655</b>	115.00	50.00	40.00	<b>80726</b>	30.00		
	0.1lb	<b>82568</b>	110.00	<b>82612</b>	100.00	<b>82654</b>	100.00	50.00	40.00	<b>80725</b>	30.00		
	0.05lb	<b>82567</b>	95.00	<b>82611</b>	90.00	<b>82653</b>	85.00	50.00	40.00	<b>80724</b>	30.00		
	0.03lb	<b>118805</b>	95.00	<b>118806</b>	85.00	<b>118807</b>	85.00	50.00	40.00	<b>80730</b>	30.00		
	0.02lb	<b>82566</b>	95.00	<b>82610</b>	85.00	<b>82652</b>	85.00	50.00	40.00	<b>80723</b>	30.00		
	0.01lb	<b>82565</b>	95.00	<b>82609</b>	85.00	<b>82651</b>	85.00	50.00	40.00	<b>80722</b>	30.00		
	0.005lb	<b>82564</b>	95.00	<b>82608</b>	85.00	<b>82650</b>	85.00	50.00	40.00	<b>80721</b>	30.00		
	0.003lb	<b>118801</b>	95.00	<b>118802</b>	85.00	<b>118803</b>	85.00	50.00	40.00	<b>118550</b>	30.00		
4oz	<b>82577</b>	125.00	<b>82621</b>	120.00	<b>82663</b>	120.00	50.00	40.00	<b>80733</b>	30.00			
2oz	<b>82576</b>	110.00	<b>82620</b>	100.00	<b>82662</b>	100.00	50.00	40.00	<b>80732</b>	30.00			
1oz	<b>82575</b>	90.00	<b>82619</b>	90.00	<b>82661</b>	85.00	50.00	40.00	<b>80731</b>	30.00			
1/2oz	<b>82574</b>	85.00	<b>82618</b>	85.00	<b>82660</b>	85.00	50.00	40.00	<b>80730</b>	30.00			
1/4oz	<b>82573</b>	85.00	<b>82617</b>	85.00	<b>82659</b>	85.00	50.00	40.00	<b>80729</b>	30.00			
1/8oz	<b>82572</b>	85.00	<b>82616</b>	85.00	<b>82658</b>	85.00	50.00	40.00	<b>80728</b>	30.00			
1/16oz	<b>82571</b>	85.00	<b>82615</b>	85.00	<b>82657</b>	85.00	50.00	40.00	<b>80719</b>	30.00			
<b>Milligram</b>	0.001lb	<b>80428</b>	85.00	<b>80443</b>	85.00	<b>80448</b>	85.00	50.00	40.00	-	-		
	0.002lb	<b>80439</b>	85.00	<b>80445</b>	85.00	<b>80449</b>	85.00	50.00	40.00	-	-		
	1/32oz	<b>80442</b>	85.00	<b>80446</b>	85.00	<b>80451</b>	85.00	50.00	40.00	-	-		

**ADDITIONAL ACCESSORIES**

Part #	Description	Price
<b>11714</b>	Weight gloves, white, cotton	\$5.00
<b>11747</b>	Lifting bar	15.00
<b>11711</b>	Weight tweezers	3.00
<b>152414</b>	Premium tweezers	35.00
<b>36092</b>	Statement of Accuracy	45.00
<b>50038</b>	Vial	3.00
<b>25836</b>	Serial number	15.00



Screw-knob Kit

TEST WEIGHTS

www.ricelake.com | Phone: 800-472-6703

**RICE LAKE**

# Avoirdupois Individual Weights

TEST WEIGHTS

	CLASS 1			CLASS 2		CLASS 3		OPTIONAL	OPTIONAL	REPLACEMENT CASES	
	Weight	Part #	Price	Part #	Price	Part #	Price	Calibration Report	Mass Value Certificate	Part #	Price
<b>Screw Knob</b>	50 lb	<b>12056</b>	\$4,390.00	<b>12202</b>	\$4,325.00	<b>12335</b>	\$4,260.00	-	-	-	-
	30 lb	<b>12055</b>	3,235.00	<b>12201</b>	3,150.00	<b>12334</b>	3,025.00	\$125.00	\$80.00	<b>80743</b>	\$200.00
	25 lb	<b>12054</b>	2,710.00	<b>12200</b>	2,655.00	<b>12333</b>	2,555.00	125.00	80.00	<b>80742</b>	200.00
	20 lb	<b>12053</b>	2,190.00	<b>12199</b>	2,125.00	<b>12332</b>	1,990.00	125.00	80.00	<b>80741</b>	200.00
	10 lb	<b>12052</b>	1,240.00	<b>12198</b>	1,205.00	<b>12331</b>	1,145.00	125.00	80.00	<b>80740</b>	200.00
	5 lb	<b>12050</b>	925.00	<b>12196</b>	885.00	<b>12330</b>	865.00	125.00	80.00	<b>80739</b>	55.00
	4 lb	<b>12049</b>	780.00	<b>12195</b>	725.00	<b>12329</b>	715.00	125.00	80.00	<b>80738</b>	55.00
	3 lb	<b>12048</b>	590.00	<b>12194</b>	540.00	<b>12328</b>	520.00	125.00	80.00	<b>80737</b>	55.00
	2 lb	<b>12047</b>	520.00	<b>12193</b>	490.00	<b>12327</b>	470.00	100.00	65.00	<b>80736</b>	55.00
	1 lb	<b>12046</b>	245.00	<b>12192</b>	245.00	<b>12326</b>	235.00	100.00	65.00	<b>80735</b>	55.00
	8 oz	<b>12044</b>	215.00	<b>12190</b>	210.00	<b>12325</b>	200.00	50.00	40.00	<b>80734</b>	30.00
	0.5 lb	<b>12034</b>	220.00	<b>12180</b>	210.00	<b>12316</b>	205.00	50.00	40.00	<b>80734</b>	30.00
	0.3 lb	<b>118518</b>	170.00	<b>118519</b>	165.00	<b>118520</b>	135.00	50.00	40.00	<b>118551</b>	30.00
	0.2 lb	<b>12033</b>	135.00	<b>12179</b>	135.00	<b>12315</b>	105.00	50.00	40.00	<b>80726</b>	30.00
	0.1 lb	<b>12032</b>	100.00	<b>12178</b>	95.00	<b>12314</b>	90.00	50.00	40.00	<b>80725</b>	30.00
	0.05 lb	<b>12027</b>	80.00	<b>12173</b>	80.00	<b>12310</b>	75.00	50.00	40.00	<b>80724</b>	30.00
	0.03 lb	<b>118514</b>	85.00	<b>118515</b>	85.00	<b>118516</b>	85.00	50.00	40.00	<b>80730</b>	30.00
	0.02 lb	<b>12022</b>	85.00	<b>12168</b>	85.00	<b>22185</b>	85.00	50.00	40.00	<b>80723</b>	30.00
	0.01 lb	<b>12020</b>	85.00	<b>12166</b>	85.00	<b>22183</b>	85.00	50.00	40.00	<b>80722</b>	30.00
	0.005 lb	<b>12013</b>	85.00	<b>12159</b>	85.00	<b>12297</b>	85.00	50.00	40.00	<b>80721</b>	30.00
	0.003 lb	<b>118510</b>	85.00	<b>118511</b>	85.00	<b>118512</b>	85.00	50.00	40.00	<b>118550</b>	30.00
	4 oz	<b>12043</b>	115.00	<b>12189</b>	115.00	<b>12324</b>	115.00	50.00	40.00	<b>80733</b>	30.00
	2 oz	<b>12042</b>	100.00	<b>12188</b>	95.00	<b>12323</b>	95.00	50.00	40.00	<b>80732</b>	30.00
	1 oz	<b>12041</b>	80.00	<b>12187</b>	80.00	<b>12322</b>	75.00	50.00	40.00	<b>80731</b>	30.00
1/2 oz	<b>12040</b>	85.00	<b>12186</b>	85.00	<b>12321</b>	85.00	50.00	40.00	<b>80730</b>	30.00	
1/4 oz	<b>12039</b>	85.00	<b>12185</b>	85.00	<b>12320</b>	85.00	50.00	40.00	<b>80729</b>	30.00	
1/8 oz	<b>12038</b>	85.00	<b>12184</b>	85.00	<b>12319</b>	85.00	50.00	40.00	<b>80728</b>	30.00	
1/16 oz	<b>12037</b>	85.00	<b>12183</b>	85.00	<b>12318</b>	85.00	50.00	40.00	<b>80719</b>	30.00	
<b>Milligram</b>	0.001 lb	<b>12007</b>	85.00	<b>12153</b>	85.00	<b>12291</b>	85.00	50.00	40.00	-	-
	0.002 lb	<b>12009</b>	85.00	<b>12155</b>	85.00	<b>12293</b>	85.00	50.00	40.00	-	-
	1/32 oz	<b>12036</b>	85.00	<b>12182</b>	85.00	<b>12317</b>	85.00	50.00	40.00	-	-

For special kits, individual weights must ship in a case.



Screw-knob Design



Milligram

www.ricelake.com | Phone: 800-472-6703

**RICE LAKE**

Precision Laboratory - ASTM  
**Avoirdupois Kits**

CLASS 4			OPTIONAL	REPLACEMENT CASES	
Weight	Kit Part #	Kit Price	Traceable Certificate	Part #	Price
50 lb	-	-	-	-	-
30 lb	<b>82709</b>	\$3,110.00	\$75.00	<b>80743</b>	\$200.00
25 lb	<b>82708</b>	2,625.00	75.00	<b>80742</b>	200.00
20 lb	<b>82707</b>	2,065.00	75.00	<b>80741</b>	200.00
10 lb	<b>82706</b>	1,215.00	75.00	<b>80740</b>	200.00
5 lb	<b>82715</b>	895.00	75.00	<b>80739</b>	55.00
4 lb	<b>82714</b>	690.00	75.00	<b>80738</b>	55.00
3 lb	<b>82713</b>	530.00	75.00	<b>80737</b>	55.00
2 lb	<b>82712</b>	480.00	60.00	<b>80736</b>	55.00
1 lb	<b>82711</b>	225.00	60.00	<b>80735</b>	55.00
8 oz	<b>82710</b>	205.00	35.00	<b>80734</b>	30.00
0.5 lb	<b>82698</b>	215.00	35.00	<b>80734</b>	30.00
0.3 lb	<b>118812</b>	145.00	35.00	<b>118551</b>	30.00
0.2 lb	<b>82697</b>	110.00	35.00	<b>80723</b>	30.00
0.1 lb	<b>82696</b>	90.00	35.00	<b>80725</b>	30.00
0.05 lb	<b>82695</b>	75.00	35.00	<b>80724</b>	30.00
0.03 lb	<b>118808</b>	75.00	35.00	<b>80730</b>	30.00
0.02 lb	<b>82694</b>	85.00	35.00	<b>80723</b>	30.00
0.01 lb	<b>82693</b>	85.00	35.00	<b>80722</b>	30.00
0.005 lb	<b>82692</b>	85.00	35.00	<b>80721</b>	30.00
0.003 lb	<b>118804</b>	85.00	35.00	<b>118550</b>	30.00
4 oz	<b>82705</b>	110.00	35.00	<b>80733</b>	30.00
2 oz	<b>82704</b>	100.00	35.00	<b>80732</b>	30.00
1 oz	<b>82703</b>	90.00	35.00	<b>80731</b>	30.00
1/2 oz	<b>82702</b>	85.00	35.00	<b>80730</b>	30.00
1/4 oz	<b>82701</b>	85.00	35.00	<b>80729</b>	30.00
1/8 oz	<b>82700</b>	85.00	35.00	<b>80728</b>	30.00
1/16 oz	<b>82699</b>	85.00	35.00	<b>80719</b>	30.00
<b>Milligram</b>					
0.001 lb	<b>80452</b>	80.00	35.00	-	-
0.002 lb	<b>80453</b>	80.00	35.00	-	-
1/32 oz	<b>80454</b>	80.00	35.00	-	-

**ADDITIONAL ACCESSORIES**

Part #	Description	Price
<b>11714</b>	Weight gloves, white, cotton	\$5.00
<b>11747</b>	Lifting bar	15.00
<b>11711</b>	Weight tweezers	3.00
<b>152414</b>	Premium tweezers	35.00
<b>36092</b>	Statement of Accuracy	45.00
<b>50038</b>	Vial	3.00
<b>80420</b>	Capsule	3.00
<b>25836</b>	Serial number	15.00



Screw-knob Kit

# Avoirdupois Individual Weights

TEST WEIGHTS

www.ricelake.com | Phone: 800-472-6703

RICELAKE

**CLASS 4**

**OPTIONAL**

**REPLACEMENT CASES**

	Weight	Part #	Price	Traceable Certificate	Part #	Price
<b>Screw Knob</b>	50 lb	<b>12438</b>	\$4,210.00	-	-	-
	30 lb	<b>12437</b>	3,000.00	\$75.00	<b>80743</b>	\$200.00
	25 lb	<b>12436</b>	2,520.00	75.00	<b>80742</b>	200.00
	20 lb	<b>12435</b>	1,955.00	75.00	<b>80741</b>	200.00
	10 lb	<b>12434</b>	1,105.00	75.00	<b>80740</b>	200.00
	5 lb	<b>12433</b>	850.00	75.00	<b>80739</b>	55.00
	4 lb	<b>12432</b>	655.00	75.00	<b>80738</b>	55.00
	3 lb	<b>12431</b>	500.00	75.00	<b>80737</b>	55.00
	2 lb	<b>12430</b>	460.00	60.00	<b>80736</b>	55.00
	1 lb	<b>12429</b>	215.00	60.00	<b>80735</b>	55.00
	8 oz	<b>12428</b>	195.00	35.00	<b>80734</b>	30.00
	0.5 lb	<b>12419</b>	205.00	35.00	<b>80734</b>	30.00
	0.3 lb	<b>118521</b>	130.00	35.00	<b>118551</b>	30.00
	0.2 lb	<b>12418</b>	100.00	35.00	<b>80723</b>	30.00
	0.1 lb	<b>12417</b>	80.00	35.00	<b>80725</b>	30.00
	0.05 lb	<b>12413</b>	70.00	35.00	<b>80724</b>	30.00
	0.03 lb	<b>118517</b>	85.00	35.00	<b>80730</b>	30.00
	0.02 lb	<b>12408</b>	85.00	35.00	<b>80723</b>	30.00
	0.01 lb	<b>12406</b>	80.00	35.00	<b>80722</b>	30.00
	0.005 lb	<b>12400</b>	80.00	35.00	<b>80721</b>	30.00
	0.003 lb	<b>118513</b>	80.00	35.00	<b>118550</b>	30.00
	4 oz	<b>12427</b>	95.00	35.00	<b>80733</b>	30.00
	2 oz	<b>12426</b>	90.00	35.00	<b>80732</b>	30.00
	1 oz	<b>12425</b>	80.00	35.00	<b>80731</b>	30.00
	1/2 oz	<b>12424</b>	85.00	35.00	<b>80730</b>	30.00
	1/4 oz	<b>12423</b>	85.00	35.00	<b>80729</b>	30.00
1/8 oz	<b>12422</b>	85.00	35.00	<b>80728</b>	30.00	
1/16 oz	<b>12421</b>	85.00	35.00	<b>80719</b>	30.00	
<b>Milligram</b>	0.001 lb	<b>12394</b>	75.00	35.00	-	-
	0.002 lb	<b>12396</b>	75.00	35.00	-	-
	1/32 oz	<b>12420</b>	75.00	35.00	-	-

For special kits-Individual weights must ship in a case.



Screw-knob Design



Milligram

Precision Laboratory - ASTM  
**Essential Weights**

**Standard Features**

- ASTM Class 1 weights
- Polished stainless steel Type II design
- Sealing cavity
- Density is approximately 7.95 g/cm<sup>3</sup>
- Special PVC weight cases or ABS case
- Precision tweezers included
- Configurations available ideal for calibration, shift test and sensitivity tests
- Other configurations available by special order



200 g PVC set shown,  
 other sets will vary

**CLASS 1\***

Weight	Part #	Kit Price
5 kg, 2 kg, 500 g, 2 g	<b>161713*</b>	\$1,200.00
2 kg, 1 kg, 500 mg	<b>161712</b>	935.00
500 g, 200 g, 50 g, 100 mg	<b>161711</b>	560.00
200 g, 100 g, 20 mg	<b>161710</b>	490.00
100 g, 50 g, 10 mg	<b>161709</b>	385.00

**REPLACEMENT CASES**

Calibration Certificate	Mass Value Certificate	Part #	Price
\$450.00	\$245.00	<b>162364*</b>	\$200.00
310.00	170.00	<b>161717</b>	435.00
340.00	190.00	<b>161716</b>	210.00
220.00	135.00	<b>161715</b>	210.00
150.00	120.00	<b>161714</b>	165.00

\*ABS plastic case

**ADDITIONAL ACCESSORIES**

PART #	DESCRIPTION	PRICE
<b>36092</b>	Statement of Accuracy	\$45.00
<b>11714</b>	Weight gloves, white cotton	5.00
<b>25836</b>	Serial number	15.00

# Metric Sets

Range: 500 mg

TEST WEIGHTS

### CLASS 0\*\*

CLASS 0**			REPLACEMENT CASES	
Set Size	Part #	Price	Part #	Price
500 mg - 1 mg	45933	\$1,735.00	34699	\$100.00
500 mg - 1 mg*	96359*	1,735.00	34699	100.00
500 mg - 10 mg	84141	1,285.00	34699	100.00
500 mg - 10 mg*	98191*	1,285.00	34699	100.00
500 mg - 100 mg	45934	885.00	34699	100.00
500 mg - 100 mg*	96360*	885.00	34699	100.00

\*\* Calibration Report included, Statement of Accuracy not available for Class 0

### CLASS 1

Set Size	Part #	Price
500 mg - 1 mg	12445	\$535.00
500 mg - 1 mg*	11910*	535.00
500 mg - 10 mg	12447	395.00
500 mg - 10 mg*	11909*	395.00
500 mg - 100 mg	45952	375.00
500 mg - 100 mg*	45944*	375.00

### CLASS 2

Part #	Price
11838	\$460.00
12176*	460.00
11848	370.00
12175*	370.00
45953	325.00
45945*	325.00

### CLASS 3

Part #	Price
11946	\$445.00
12313*	445.00
11956	325.00
12312*	325.00
45954	260.00
45946*	260.00

### OPTIONAL

Calibration Report
\$450.00
450.00
300.00
300.00
150.00
150.00

### OPTIONAL

Mass Value Certificate
\$360.00
360.00
240.00
240.00
120.00
120.00

### REPLACEMENT CASES\*

Part #	Price
11763	\$70.00
11763	70.00
11763	70.00
11763	70.00
11763	70.00
11763	70.00

\*Includes milligram lid and tweezer

### CLASS 4

CLASS 4			OPTIONAL	REPLACEMENT CASES	
Set Size	Part #	Price	Traceable Certificate	Part #	Price
500 mg - 1 mg	12093	\$280.00	\$270.00	11763	\$70.00
500 mg - 1 mg*	12416*	280.00	270.00	11763	70.00
500 mg - 10 mg	12103	210.00	180.00	11763	70.00
500 mg - 10 mg*	12415*	210.00	180.00	11763	70.00
500 mg - 100 mg	45955	165.00	90.00	11763	70.00
500 mg - 100 mg*	45947*	165.00	90.00	11763	70.00

\* 5-2-2-1 Configuration

www.ricelake.com | Phone: 800-472-6703

RICELAKE



Set includes lifting device and glove



# Metric Sets

Range: 500mg

## WEIGHT SET CONTENTS

500 mg - 1 mg	500 mg - 1 mg*	500 mg - 10 mg	500 mg - 10 mg*	500 mg - 100 mg	500 mg - 100 mg*
1 - 500 mg	1 - 500 mg	1 - 500 mg	1 - 500 mg	1 - 500 mg	1 - 500 mg
1 - 300 mg	2 - 200 mg	1 - 300 mg	2 - 200 mg	1 - 300 mg	2 - 200 mg
1 - 200 mg	1 - 100 mg	1 - 200 mg	1 - 100 mg	1 - 200 mg	1 - 100 mg
1 - 100 mg	1 - 50 mg	1 - 100 mg	1 - 50 mg	1 - 100 mg	
1 - 50 mg	2 - 20 mg	1 - 50 mg	2 - 20 mg		
1 - 30 mg	1 - 10 mg	1 - 30 mg	1 - 10 mg		
1 - 20 mg	1 - 5 mg	1 - 20 mg			
1 - 10 mg	2 - 2 mg	1 - 10 mg			
1 - 5 mg	1 - 1 mg				
1 - 3 mg					
1 - 2 mg					
1 - 1 mg					
<b>Piece Count</b>					
12	12	8	8	4	4
<b>Total Weight</b>					
1.221 g	1.11 g	1.21 g	1.11 g	1.1 g	.8g
Part #	Part #	Part #	Part #	Part #	Part #
45933-Class 0	96359-Class 0	84141-Class 0	98191-Class 0	45934-Class 0	96360-Class 0
12445-Class 1	11910-Class 1	12447-Class 1	11909-Class 1	45952-Class 1	45944-Class 1
11838-Class 2	12176-Class 2	11848-Class 2	12175-Class 2	45953-Class 2	45945-Class 2
11946-Class 3	12313-Class 3	11956-Class 3	12312-Class 3	45954-Class 3	45946-Class 3
12093-Class 4	12416-Class 4	12103-Class 4	12415-Class 4	45955-Class 4	45947-Class 4

\* 5-2-2-1 Configuration

## ADDITIONAL ACCESSORIES

Part #	Description	Price
36092	Statement of Accuracy	\$45.00
11714	Weight gloves, white cotton	5.00
11711	Tweezer	3.00
152414	Premium tweezer	35.00
25836	Serial number	15.00

# Metric Sets

Range: 20g

TEST WEIGHTS

### CLASS 0\*\*

### REPLACEMENT CASES

Set Size	Part #	Price	Part #	Price
20g - 1 mg	<b>84154</b>	\$2,370.00	<b>49503</b>	\$200.00
20g - 5 mg	<b>84149</b>	2,535.00	<b>49503</b>	200.00
20g - 10 mg	<b>84148</b>	2,360.00	<b>49503</b>	200.00
20g - 100 mg	<b>84146</b>	1,775.00	<b>49503</b>	200.00
20g - 1 g	<b>84155</b>	1,280.00	<b>49503</b>	200.00

\*\* Calibration Report included, Statement of Accuracy not available for Class 0

### CLASS 1

### CLASS 2

### CLASS 3

### OPTIONAL

### OPTIONAL

### REPLACEMENT CASES

Set Size	Part #	Price	Part #	Price	Part #	Price	Calibration Report	Mass Value Certificate	Part #	Price
20g - 1 mg	<b>12448</b>	\$925.00	<b>11853</b>	\$770.00	<b>11961</b>	\$700.00	\$675.00	\$540.00	<b>11596</b>	\$145.00
20g - 1 mg	<b>11908*</b>	925.00	<b>12174*</b>	770.00	<b>12311*</b>	700.00	675.00	540.00	<b>11588</b>	145.00
20g - 5 mg	<b>12450</b>	795.00	<b>11858</b>	685.00	<b>11966</b>	625.00	565.00	450.00	<b>11596</b>	145.00
20g - 5 mg	<b>11907*</b>	795.00	<b>12172*</b>	685.00	<b>12309*</b>	625.00	565.00	450.00	<b>11588</b>	145.00
20g - 10 mg	<b>12451</b>	760.00	<b>11863</b>	620.00	<b>11971</b>	565.00	525.00	420.00	<b>11596</b>	145.00
20g - 10 mg	<b>11906*</b>	760.00	<b>12171*</b>	620.00	<b>22188*</b>	565.00	525.00	420.00	<b>11588</b>	145.00
20g - 100 mg	<b>84145</b>	645.00	<b>84144</b>	545.00	<b>84143</b>	510.00	375.00	300.00	<b>11596</b>	145.00
20g - 100 mg	<b>11905*</b>	645.00	<b>12170*</b>	545.00	<b>22187*</b>	510.00	375.00	300.00	<b>11588</b>	145.00
20g - 1 g	<b>12452</b>	535.00	<b>11868</b>	460.00	<b>11976</b>	400.00	225.00	180.00	<b>11596</b>	145.00
20g - 1 g	<b>11904*</b>	535.00	<b>12169*</b>	460.00	<b>22186*</b>	400.00	225.00	180.00	<b>11588</b>	145.00

### CLASS 4

### OPTIONAL

### REPLACEMENT CASES

Set Size	Part #	Price	Traceable Certificate	Part #	Price
20g - 1 mg	<b>12108</b>	\$540.00	\$410.00	<b>11596</b>	\$145.00
20g - 1 mg	<b>12414*</b>	540.00	410.00	<b>11588</b>	145.00
20g - 5 mg	<b>12113</b>	500.00	340.00	<b>11596</b>	145.00
20g - 5 mg	<b>12412*</b>	500.00	340.00	<b>11588</b>	145.00
20g - 10 mg	<b>12118</b>	480.00	310.00	<b>11596</b>	145.00
20g - 10 mg	<b>12411*</b>	480.00	310.00	<b>11588</b>	145.00
20g - 100 mg	<b>84142</b>	400.00	225.00	<b>11596</b>	145.00
20g - 100 mg	<b>12410*</b>	400.00	225.00	<b>11588</b>	145.00
20g - 1 g	<b>12123</b>	325.00	135.00	<b>11596</b>	145.00
20g - 1 g	<b>12409*</b>	325.00	135.00	<b>11588</b>	145.00

\* 5-2-2-1 Configuration



Set includes lifting device and gloves

www.ricelake.com | Phone: 800-472-6703

RICELAKE

# Metric Sets

Range: 20g

## WEIGHT SET CONTENTS

20g - 1mg	20g - 1mg*	20g - 5mg	20g - 5mg*	20g - 10mg	20g - 10mg*	20g - 100mg	20g - 100mg*	20g - 1g	20g - 1g*
1 - 20g	1 - 20g	1 - 20g	1 - 20g	1 - 20g	1 - 20g	1 - 20g	1 - 20g	1 - 20g	1 - 20g
1 - 10g	1 - 10g	1 - 10g	1 - 10g	1 - 10g	1 - 10g	1 - 10g	1 - 10g	1 - 10g	1 - 10g
1 - 5g	1 - 5g	1 - 5g	1 - 5g	1 - 5g	1 - 5g	1 - 5g	1 - 5g	1 - 5g	1 - 5g
1 - 3g	2 - 2g	1 - 3g	2 - 2g	1 - 3g	2 - 2g	1 - 3g	2 - 2g	1 - 3g	2 - 2g
1 - 2g	1 - 1g	1 - 2g	1 - 1g	1 - 2g	1 - 1g	1 - 2g	1 - 1g	1 - 2g	1 - 1g
1 - 1g	1 - 500mg	1 - 1g	1 - 500mg	1 - 1g	1 - 500mg	1 - 1g	1 - 500mg	1 - 1g	1 - 1g
1 - 500mg	2 - 200mg	1 - 500mg	2 - 200mg	1 - 500mg	2 - 200mg	1 - 500mg	2 - 200mg		
1 - 300mg	1 - 100mg	1 - 300mg	1 - 100mg	1 - 300mg	1 - 100mg	1 - 300mg	1 - 100mg		
1 - 200mg	1 - 50mg	1 - 200mg	1 - 50mg	1 - 200mg	1 - 50mg	1 - 200mg			
1 - 100mg	2 - 20mg	1 - 100mg	2 - 20mg	1 - 100mg	2 - 20mg	1 - 100mg			
1 - 50mg	1 - 10mg	1 - 50mg	1 - 10mg	1 - 50mg	1 - 10mg				
1 - 30mg	1 - 5mg	1 - 30mg	1 - 5mg	1 - 30mg					
1 - 20mg	2 - 2mg	1 - 20mg		1 - 20mg					
1 - 10mg	1 - 1mg	1 - 10mg		1 - 10mg					
1 - 5mg		1 - 5mg							
1 - 3mg									
1 - 2mg									
1 - 1mg									

**Piece Count**

18	18	15	15	14	14	10	10	6	6
----	----	----	----	----	----	----	----	---	---

**Total Weight**

42.221g	42.221g	42.215g	42.215g	42.421g	41.1g	41g	41g	42.105g	40g
Part #	Part #	Part #	Part #	Part #	Part #	Part #	Part #	Part #	Part #
84154-Class 0	-	84149-Class 0	-	84148-Class 0	-	84146-Class 0	-	84155-Class 0	-
12448-Class 1	11908-Class 1	12450-Class 1	11907-Class 1	12451-Class 1	11906-Class 1	84145-Class 1	11905-Class 1	12452-Class 1	11904-Class 1
11853-Class 2	12174-Class 2	11858-Class 2	12172-Class 2	11863-Class 2	12171-Class 2	84144-Class 2	12170-Class 2	11868-Class 2	12169-Class 2
11961-Class 3	12311-Class 3	11966-Class 3	12309-Class 3	11971-Class 3	22188-Class 3	84143-Class 3	22187-Class 3	11976-Class 3	22186-Class 3
12108-Class 4	12414-Class 4	12113-Class 4	12412-Class 4	12118-Class 4	12411-Class 4	84142-Class 4	12410-Class 4	12123-Class 4	12409-Class 4

\* 5-2-2-1 Configuration

## ADDITIONAL ACCESSORIES

Part #	Description	Price
36092	Statement of Accuracy	\$45.00
11714	Weight gloves, white cotton	5.00
11711	Tweezer	3.00
152414	Premium tweezer	35.00
25836	Serial number	15.00
11755	Leaf weight cover	35.00

# Metric Sets

Range: 50g

TEST WEIGHTS

### CLASS 0\*\*

Set Size	Part #	Price	Part #	Price
50g - 1 mg	<b>84177</b>	\$3,065.00	<b>49503</b>	\$200.00
50g - 5 mg	<b>84176</b>	2,850.00	<b>49503</b>	200.00
50g - 10 mg	<b>84164</b>	2,580.00	<b>49503</b>	200.00
50g - 100 mg	<b>84163</b>	1,965.00	<b>49503</b>	200.00
50g - 1 g	<b>84178</b>	1,540.00	<b>49503</b>	200.00

### REPLACEMENT CASES

\*\* Calibration Report included, Statement of Accuracy not available for Class 0

### CLASS 1

Set Size	Part #	Price
50g - 1 mg	<b>12453</b>	\$910.00
50g - 1 mg*	<b>11903</b>	910.00
50g - 5 mg	<b>12454</b>	850.00
50g - 5 mg*	<b>11902</b>	850.00
50g - 10 mg	<b>12455</b>	800.00
50g - 10 mg *	<b>11900</b>	800.00
50g - 100 mg	<b>84159</b>	695.00
50g - 100 mg *	<b>11899</b>	695.00
50g - 1 g	<b>12456</b>	575.00
50g - 1 g*	<b>11898</b>	575.00

### CLASS 2

Part #	Price
<b>11873</b>	\$800.00
<b>12167*</b>	800.00
<b>11879</b>	730.00
<b>12165*</b>	730.00
<b>11880</b>	695.00
<b>12163*</b>	695.00
<b>84160</b>	555.00
<b>12162*</b>	555.00
<b>11890</b>	500.00
<b>12161*</b>	500.00

### CLASS 3

Part #	Price
<b>11982</b>	\$750.00
<b>22288*</b>	750.00
<b>11988</b>	660.00
<b>22182*</b>	660.00
<b>11989</b>	635.00
<b>22181*</b>	635.00
<b>84161</b>	530.00
<b>12300*</b>	530.00
<b>12004</b>	455.00
<b>12299*</b>	455.00

### OPTIONAL

Calibration Report	Price
	\$750.00
	750.00
	640.00
	640.00
	600.00
	600.00
	450.00
	450.00
	300.00
	300.00

### OPTIONAL

Mass Value Certificate	Price
	\$600.00
	600.00
	510.00
	510.00
	480.00
	480.00
	360.00
	360.00
	240.00
	240.00

### REPLACEMENT CASES

Part #	Price
<b>11596</b>	\$145.00
<b>11588</b>	145.00
<b>11596</b>	145.00
<b>11588</b>	145.00
<b>11596</b>	145.00
<b>11588</b>	145.00
<b>11596</b>	145.00
<b>11588</b>	145.00
<b>11596</b>	145.00
<b>11588</b>	145.00

### CLASS 4

Set Size	Part #	Price
50g - 1 mg	<b>12128</b>	\$635.00
50g - 1 mg*	<b>12407</b>	635.00
50g - 5 mg	<b>12134</b>	580.00
50g - 5 mg*	<b>12405</b>	580.00
50g - 10 mg	<b>12135</b>	560.00
50g - 10 mg *	<b>12404</b>	560.00
50g - 100 mg	<b>84162</b>	480.00
50g - 100 mg *	<b>12403</b>	480.00
50g - 1 g	<b>12150</b>	400.00
50g - 1 g*	<b>12402</b>	400.00

### OPTIONAL

Traceable Certificate	Price
	\$455.00
	455.00
	385.00
	385.00
	365.00
	365.00
	270.00
	270.00
	180.00
	180.00

### REPLACEMENT CASES

Part #	Price
<b>11596</b>	\$145.00
<b>11588</b>	145.00
<b>11596</b>	145.00
<b>11588</b>	145.00
<b>11596</b>	145.00
<b>11588</b>	145.00
<b>11596</b>	145.00
<b>11588</b>	145.00
<b>11596</b>	145.00
<b>11588</b>	145.00

\* 5-2-2-1 Configuration

www.ricelake.com | Phone: 800-472-6703

RICELAKE



Set includes lifting device and gloves

# Metric Sets

Range: 50g

## WEIGHT SET CONTENTS

50g - 1mg	50g - 1mg*	50g - 5mg	50g - 5mg*	50g - 10mg	50g - 10mg*	50g - 100mg	50g - 100mg*	50g - 1g	50g - 1g*
1 - 50g	1 - 50g	1 - 50g	1 - 50g	1 - 50g	1 - 50g	1 - 50g	1 - 50g	1 - 50g	1 - 50g
1 - 30g	2 - 20g	1 - 30g	2 - 20g	1 - 30g	2 - 20g	1 - 30g	2 - 20g	1 - 30g	2 - 20g
1 - 20g	1 - 10g	1 - 20g	1 - 10g	1 - 20g	1 - 10g	1 - 20g	1 - 10g	1 - 20g	1 - 10g
1 - 10g	1 - 5g	1 - 10g	1 - 5g	1 - 10g	1 - 5g	1 - 10g	1 - 5g	1 - 10g	1 - 5g
1 - 5g	2 - 2g	1 - 5g	2 - 2g	1 - 5g	2 - 2g	1 - 5g	2 - 2g	1 - 5g	2 - 2g
1 - 3g	1 - 1g	1 - 3g	1 - 1g	1 - 3g	1 - 1g	1 - 3g	1 - 1g	1 - 3g	1 - 1g
1 - 2g	1 - 500mg	1 - 2g	1 - 500mg	1 - 2g	1 - 500mg	1 - 2g	1 - 500mg	1 - 2g	
1 - 1g	2 - 200mg	1 - 1g	2 - 200mg	1 - 1g	2 - 200mg	1 - 1g	2 - 200mg	1 - 1g	
1 - 500mg	1 - 100mg	1 - 500mg	1 - 100mg	1 - 500mg	1 - 100mg	1 - 500mg	1 - 100mg		
1 - 300mg	1 - 50mg	1 - 300mg	1 - 50mg	1 - 300mg	1 - 50mg	1 - 300mg			
1 - 200mg	2 - 20mg	1 - 200mg	2 - 20mg	1 - 200mg	2 - 20mg	1 - 200mg			
1 - 100mg	1 - 10mg	1 - 100mg	1 - 10mg	1 - 100mg	1 - 10mg	1 - 100mg			
1 - 50mg	1 - 5mg	1 - 50mg	1 - 5mg	1 - 50mg					
1 - 30mg	2 - 2mg	1 - 30mg		1 - 30mg					
1 - 20mg	1 - 1mg	1 - 20mg		1 - 20mg					
1 - 10mg		1 - 10mg		1 - 10mg					
1 - 5mg		1 - 5mg							
1 - 3mg									
1 - 2mg									
1 - 1mg									

### Piece Count

20	20	17	17	16	16	12	12	8	8
----	----	----	----	----	----	----	----	---	---

### Total Weight

122.221g	111.11g	122.215g	111.105g	122.21g	111.1g	122.1g	111g	121g	110g
Part #	Part #	Part #	Part #	Part #	Part #	Part #	Part #	Part #	Part #
84177-Class 0	-	84176-Class 0	-	84164-Class 0	-	84163-Class 0	-	84178-Class 0	-
12453-Class 1	11903-Class 1	12454-Class 1	11902-Class 1	12455-Class 1	11900-Class 1	84159-Class 1	11899-Class 1	12456-Class 1	11898-Class 1
11873-Class 2	12167-Class 2	11879-Class 2	12165-Class 2	11880-Class 2	12163-Class 2	84160-Class 2	12162-Class 2	11890-Class 2	12161-Class 2
11982-Class 3	22288-Class 3	11988-Class 3	22182-Class 3	11989-Class 3	22181-Class 3	84161-Class 3	12300-Class 3	12004-Class 3	12299-Class 3
12128-Class 4	12407-Class 4	12134-Class 4	12405-Class 4	12135-Class 4	12404-Class 4	84162-Class 4	12403-Class 4	12150-Class 4	12402-Class 4

\* 5-2-2-1 Configuration

## ADDITIONAL ACCESSORIES

Part #	Description	Price
36092	Statement of Accuracy	\$45.00
11714	Weight gloves, white cotton	5.00
11711	Tweezer	3.00
152414	Premium tweezer	35.00
25836	Serial number	15.00
11755	Leaf weight cover	35.00

# Metric Sets

Range: 100g

TEST WEIGHTS

### CLASS 0\*\*

Set Size	Part #	Price	REPLACEMENT CASES	
			Part #	Price
100g - 1 mg	<b>45930</b>	\$3,365.00	<b>49503</b>	\$200.00
100g - 5 mg	<b>84211</b>	2,935.00	<b>49503</b>	200.00
100g - 10 mg	<b>84212</b>	2,720.00	<b>49503</b>	200.00
100g - 100 mg	<b>45931</b>	2,255.00	<b>49503</b>	200.00
100g - 1 g	<b>45932</b>	1,635.00	<b>49503</b>	200.00

\*\* Calibration Report included, Statement of Accuracy not available for Class 0

### CLASS 1

Set Size	Part #	Price	CLASS 2		CLASS 3		OPTIONAL	OPTIONAL	REPLACEMENT CASES	
			Part #	Price	Part #	Price	Calibration Report	Mass Value Certificate	Part #	Price
100g - 1 mg	<b>12457</b>	\$985.00	<b>11901</b>	\$860.00	<b>12018</b>	\$815.00	\$790.00	\$590.00	<b>11596</b>	\$145.00
100g - 1 mg *	<b>11897</b>	985.00	<b>12160</b>	860.00	<b>12298</b>	815.00	790.00	590.00	<b>11588</b>	145.00
100g - 5 mg	<b>11911</b>	875.00	<b>12158</b>	765.00	<b>12031</b>	720.00	675.00	520.00	<b>11596</b>	145.00
100g - 5 mg*	<b>11896</b>	875.00	-	-	<b>12296</b>	720.00	675.00	520.00	<b>11588</b>	145.00
100g - 10 mg	<b>12460</b>	860.00	<b>11912</b>	750.00	<b>12035</b>	715.00	640.00	510.00	<b>11596</b>	145.00
100g - 10 mg*	<b>11895</b>	860.00	<b>12157</b>	750.00	<b>12295</b>	715.00	640.00	510.00	<b>11588</b>	145.00
100g - 100 mg	<b>45956</b>	700.00	<b>45957</b>	730.00	<b>45958</b>	680.00	490.00	390.00	<b>11596</b>	145.00
100g - 100 mg*	<b>45948</b>	700.00	<b>45949</b>	730.00	<b>45950</b>	680.00	490.00	390.00	<b>11588</b>	145.00
100g - 1 g	<b>12461</b>	625.00	<b>11913</b>	615.00	<b>12045</b>	600.00	340.00	270.00	<b>11596</b>	145.00
100g - 1 g*	<b>11894</b>	625.00	<b>12156</b>	615.00	<b>12294</b>	600.00	340.00	270.00	<b>11588</b>	145.00

### CLASS 4

Set Size	Part #	Price	OPTIONAL	REPLACEMENT CASES	
			Traceable Certificate	Part #	Price
100g - 1 mg	<b>12164</b>	\$735.00	\$485.00	<b>11596</b>	\$145.00
100g - 1 mg *	<b>12401</b>	735.00	485.00	<b>11588</b>	145.00
100g - 5 mg	<b>12177</b>	720.00	410.00	<b>11596</b>	145.00
100g - 5 mg*	<b>12399</b>	720.00	410.00	<b>11588</b>	145.00
100g - 10 mg	<b>12181</b>	715.00	380.00	<b>11596</b>	145.00
100g - 10 mg*	<b>12398</b>	715.00	380.00	<b>11588</b>	145.00
100g - 100 mg	<b>45959</b>	595.00	295.00	<b>11596</b>	145.00
100g - 100 mg*	<b>45951</b>	595.00	295.00	<b>11588</b>	145.00
100g - 1 g	<b>12191</b>	525.00	205.00	<b>11596</b>	145.00
100g - 1 g*	<b>12397</b>	525.00	205.00	<b>11588</b>	145.00

\* 5-2-2-1 Configuration



Set includes lifting device and gloves

www.ricelake.com | Phone: 800-472-6703

RICELAKE

# Metric Sets

Range: 100g

## WEIGHT SET CONTENTS

100g - 1 mg	100g - 1 mg*	100g - 5mg	100g - 5mg*	100g - 10mg	100g - 10mg*	100g - 100mg	100g - 100mg*	100g - 1g	100g - 1g*
1 - 100g	1 - 100g	1 - 100g	1 - 100g	1 - 100g	1 - 100g	1 - 100g	1 - 100g	1 - 100g	1 - 100g
1 - 50g	1 - 50g	1 - 50g	1 - 50g	1 - 50g	1 - 50g	1 - 50g	1 - 50g	1 - 50g	1 - 50g
1 - 30g	2 - 20g	1 - 30g	2 - 20g	1 - 30g	2 - 20g	1 - 30g	2 - 20g	1 - 30g	2 - 20g
1 - 20g	1 - 10g	1 - 20g	1 - 10g	1 - 20g	1 - 10g	1 - 20g	1 - 10g	1 - 20g	1 - 10g
1 - 10g	1 - 5g	1 - 10g	1 - 5g	1 - 10g	1 - 5g	1 - 10g	1 - 5g	1 - 10g	1 - 5g
1 - 5g	2 - 2g	1 - 5g	2 - 2g	1 - 5g	2 - 2g	1 - 5g	2 - 2g	1 - 5g	2 - 2g
1 - 3g	1 - 1g	1 - 3g	1 - 1g	1 - 3g	1 - 1g	1 - 3g	1 - 1g	1 - 3g	1 - 1g
1 - 2g	1 - 500mg	1 - 2g	1 - 500mg	1 - 2g	1 - 500mg	1 - 2g	1 - 500mg	1 - 2g	
1 - 1g	2 - 200mg	1 - 1g	2 - 200mg	1 - 1g	2 - 200mg	1 - 1g	2 - 200mg	1 - 1g	
1 - 500mg	1 - 100mg	1 - 500mg	1 - 100mg	1 - 500mg	1 - 100mg	1 - 500mg	1 - 100mg		
1 - 300mg	1 - 50mg	1 - 300mg	1 - 50mg	1 - 300mg	1 - 50mg	1 - 300mg			
1 - 200mg	2 - 20mg	1 - 200mg	2 - 20mg	1 - 200mg	2 - 20mg	1 - 200mg			
1 - 100mg	1 - 10mg	1 - 100mg	1 - 10mg	1 - 100mg	1 - 10mg	1 - 100mg			
1 - 50mg	1 - 5mg	1 - 50mg	1 - 5mg	1 - 50mg					
1 - 30mg	2 - 2mg	1 - 30mg		1 - 30mg					
1 - 20mg	1 - 1mg	1 - 20mg		1 - 20mg					
1 - 10mg		1 - 10mg		1 - 10mg					
1 - 5mg		1 - 5mg							
1 - 3mg									
1 - 2mg									
1 - 1mg									

### Piece Count

21	21	18	18	17	17	13	13	9	9
----	----	----	----	----	----	----	----	---	---

### Total Weight

222.221g	211.11g	222.215g	211.085g	222.21g	211.1g	222.1g	211g	221g	210g
Part #	Part #	Part #	Part #	Part #	Part #	Part #	Part #	Part #	Part #
45930-Class 0	-	84211-Class 0	-	84212-Class 0	-	45931-Class 0	-	45932-Class 0	-
12457-Class 1	11897-Class 1	11911-Class 1	11896-Class 1	12460-Class 1	11895-Class 1	45956-Class 1	45948-Class 1	12461-Class 1	11894-Class 1
11901-Class 2	12160-Class 2	12158-Class 2	-	11912-Class 2	12157-Class 2	45957-Class 2	45949-Class 2	11913-Class 2	12156-Class 2
12018-Class 3	12298-Class 3	12031-Class 3	12296-Class 3	12035-Class 3	12295-Class 3	45958-Class 3	45950-Class 3	12045-Class 3	12294-Class 3
12164-Class 4	12401-Class 4	12177-Class 4	12399-Class 4	12181-Class 4	12398-Class 4	45959-Class 4	45951-Class 4	12191-Class 4	12397-Class 4

## ADDITIONAL ACCESSORIES

Part #	Description	Price
36092	Statement of Accuracy	\$45.00
11714	Weight gloves, white cotton	5.00
11711	Tweezer	3.00
152414	Premium tweezer	35.00
25836	Serial number	15.00
11755	Leaf weight cover	35.00

# Metric Sets

Range: 200 g

TEST WEIGHTS

### CLASS 0\*\*

Set Size	Part #	Price	Part #	Price
200 g - 1 mg	45927	\$3,720.00	34645	\$270.00
200 g - 1 mg*	156298	3,720.00	34645	270.00
(2) 200 g x 1 mg*	87039	4,145.00	34645	270.00
200 g - 10 mg	84213	3,345.00	34645	270.00
(2) 200 g x 10 mg*	87038	3,600.00	34645	270.00
200 g - 100 mg	45928	2,905.00	34645	270.00
(2) 200 g x 100 mg*	87037	3,110.00	34645	270.00
200 g - 1 g	45929	1,945.00	34645	270.00
(2) 200 g x 1 g*	87040	2,310.00	34645	270.00

### REPLACEMENT CASES

\*\* Calibration Report included, Statement of Accuracy not available for Class 0

### CLASS 1

Set Size	Part #	Price
200 g - 1 mg	12462	\$1,050.00
200 g - 1 mg*	156299	1,050.00
(2) 200 g x 1 mg*	87053	1,110.00
200 g - 10 mg	12467	960.00
(2) 200 g x 10 mg*	87049	1,100.00
200 g - 100 mg	45960	920.00
(2) 200 g x 100 mg*	87045	1,070.00
200 g - 1 g	12468	780.00
200 g - 1 g*	11893	780.00
(2) 200 g x 1 g*	87057	885.00

### CLASS 2

Part #	Price
11914	\$1,005.00
156300	1,005.00
87054	1,055.00
11916	825.00
87050	1,025.00
45961	790.00
87046	1,000.00
11917	730.00
12154	730.00
87058	755.00

### CLASS 3

Part #	Price
12051	\$995.00
156301	995.00
87055	1,050.00
12064	800.00
87051	1,000.00
45962	730.00
87047	995.00
12065	725.00
12292	725.00
87059	750.00

### OPTIONAL

Calibration Report	Mass Value Certificate
\$880.00	\$630.00
880.00	630.00
970.00	645.00
730.00	515.00
820.00	595.00
580.00	430.00
670.00	475.00
430.00	310.00
430.00	310.00
520.00	355.00

### OPTIONAL

Calibration Report	Mass Value Certificate
\$880.00	\$630.00
880.00	630.00
970.00	645.00
730.00	515.00
820.00	595.00
580.00	430.00
670.00	475.00
430.00	310.00
430.00	310.00
520.00	355.00

### REPLACEMENT CASES

Part #	Price
34645	\$270.00
34645	270.00
34645	270.00
34645	270.00
34645	270.00
34645	270.00
34645	270.00
34645	270.00
34645	270.00
34645	270.00

### CLASS 4

Set Size	Part #	Price
200 g - 1 mg	12197	\$780.00
200 g - 1 mg*	156302	780.00
(2) 200 g x 1 mg*	87056	850.00
200 g - 10 mg	12210	740.00
(2) 200 g x 10 mg*	87052	815.00
200 g - 100 mg	45963	665.00
(2) 200 g x 100 mg*	87048	780.00
200 g - 1 g	12211	560.00
200 g - 1 g*	12395	560.00
(2) 200 g x 1 g*	87060	660.00

### OPTIONAL

Traceable Certificate
\$510.00
510.00
540.00
420.00
450.00
325.00
360.00
235.00
235.00
270.00

### REPLACEMENT CASES

Part #	Price
34645	\$270.00
34645	270.00
34645	270.00
34645	270.00
34645	270.00
34645	270.00
34645	270.00
34645	270.00
34645	270.00
34645	270.00

\* 5-2-2-1 Configuration



Set includes lifting device and gloves

www.ricelake.com | Phone: 800-472-6703

RICELAKE



# Metric Sets

Range: 200g

## WEIGHT SET CONTENTS

200g - 1 mg	200g - 1 mg*	(2) 200g - 1 mg*	200g - 10mg	(2) 200g - 10mg*	200g - 100mg	(2) 200g - 100mg*	200g - 1g	200g - 1g*	(2) 200g - 1g*
1 - 200g	1 - 200g	2 - 200g	1 - 200g	2 - 200g	1 - 200g	2 - 200g	1 - 200g	1 - 200g	2 - 200g
1 - 100g	1 - 100g	1 - 100g	1 - 100g	1 - 100g	1 - 100g	1 - 100g	1 - 100g	1 - 100g	1 - 100g
1 - 50g	1 - 50g	1 - 50g	1 - 50g	1 - 50g	1 - 50g	1 - 50g	1 - 50g	1 - 50g	1 - 50g
1 - 30g	2 - 20g		1 - 30g	2 - 20g	1 - 30g	2 - 20g	1 - 30g	2 - 20g	2 - 20g
1 - 20g	1 - 10g	2 - 20g	1 - 20g	1 - 10g	1 - 20g	1 - 10g	1 - 20g	1 - 10g	1 - 10g
1 - 10g	1 - 5g	1 - 10g	1 - 10g	1 - 5g	1 - 10g	1 - 5g	1 - 10g	1 - 5g	1 - 5g
1 - 5g	2 - 2g	1 - 5g	1 - 5g	2 - 2g	1 - 5g	2 - 2g	1 - 5g	2 - 2g	2 - 2g
1 - 3g	1 - 1g		1 - 3g	1 - 1g	1 - 3g	1 - 1g	1 - 3g	1 - 1g	1 - 1g
1 - 2g	1 - 500mg	2 - 2g	1 - 2g	1 - 500mg	1 - 2g	1 - 500mg	1 - 2g		
1 - 1g	2 - 200mg	1 - 1g	1 - 1g	2 - 200mg	1 - 1g	2 - 200mg	1 - 1g		
1 - 500mg	1 - 100mg	1 - 500mg	1 - 500mg	1 - 100mg	1 - 500mg	1 - 100mg			
1 - 300mg	1 - 50mg		1 - 300mg	1 - 50mg	1 - 300mg				
1 - 200mg	2 - 20mg	2 - 200mg	1 - 200mg	2 - 20mg	1 - 200mg				
1 - 100mg	1 - 10mg	1 - 100mg	1 - 100mg	1 - 10mg	1 - 100mg				
1 - 50mg	1 - 5mg	1 - 50mg	1 - 50mg						
1 - 30mg	2 - 2mg		1 - 30mg						
1 - 20mg	1 - 1mg	2 - 20mg	1 - 20mg						
1 - 10mg		1 - 10mg	1 - 10mg						
1 - 5mg		1 - 5mg							
1 - 3mg									
1 - 2mg		2 - 2mg							
1 - 1mg		1 - 1mg							

### Piece Count

22	22	23	18	19	14	15	10	10	11
----	----	----	----	----	----	----	----	----	----

### Total Weight

422.221g	422.221g	622.221g	422.210g	611.1g	422.19g	611g	421g	410g	610g
Part #	Part #	Part #	Part #	Part #	Part #	Part #	Part #	Part #	Part #
45927-Class 0	156298-Class 0	87039-Class 0	84213-Class 0	87038-Class 0	45928-Class 0	87037-Class 0	45929-Class 0		87040-Class 0
12462-Class 1	156299-Class 1	87053-Class 1	12467-Class 1	87049-Class 1	45960-Class 1	87045-Class 1	12468-Class 1	11893-Class 1	87057-Class 1
11914-Class 2	156300-Class 2	87054-Class 2	11916-Class 2	87050-Class 2	45961-Class 2	87046-Class 2	11917-Class 2	12154-Class 2	87058-Class 2
12051-class 3	156301-Class 3	87055-Class 3	12064-Class 3	87051-Class 3	45962-Class 3	87047-Class 3	12065-Class 3	12292-Class 3	87059-Class 3
12197-Class 4	156302-Class 4	87056-Class 4	12210-Class 4	87052-Class 4	45963-Class 4	87048-Class 4	12211-Class 4	12395-Class 4	87060-Class 4

\* 5-2-2-1 Configuration

### CASE INSERT CLASS 0

Size	Part #	Price
200g - 1 mg	50431	\$100.00
(2) 200g x 1 mg*	84473	325.00
(2) 200g x 10mg*	84473	325.00
(2) 200g x 100mg*	84473	325.00
20 - 1g	50430	100.00
(2) 200 x 1g*	84472	325.00

### CASE INSERT CLASS 1 - 4

Size	Part #	Price
200g - 1 mg	11601	\$160.00
(2) 200 x 1g*	84465	160.00
(2) 200g x 1mg*	84464	160.00
200 - 1g	11587	160.00

### ADDITIONAL ACCESSORIES

Part #	Description	Price
36092	Statement of Accuracy	\$45.00
11714	Weight gloves, white cotton	5.00
11711	Tweezer	3.00
152414	Premium tweezer	35.00
25836	Serial number	15.00
11755	Leaf weight cover	35.00
50035	Weight forceps, plastic	35.00
11747	Lifter bar	15.00

# Metric Sets

Range: 300g and 500g

**CLASS 0\*\***

**REPLACEMENT CASES**

Set Size	Part #	Price	Part #	Price
500g - 1 mg	<b>45923</b>	\$4,660.00	<b>34645</b>	\$270.00
500g - 100mg	<b>45924</b>	3,670.00	<b>34645</b>	270.00
500g - 1g	<b>45925</b>	3,040.00	<b>34645</b>	270.00
500g - 100g	<b>45926</b>	1,905.00	<b>34645</b>	270.00

\*\* Calibration Report included, Statement of Accuracy not available Class 0

**CLASS 1**

**CLASS 2**

**CLASS 3**

**OPTIONAL**

**OPTIONAL**

**REPLACEMENT CASES**

Set Size	Part #	Price	Part #	Price	Part #	Price	Calibration Report	Mass Value Certificate	Part #	Price
300g - 1g	<b>11892</b>	\$1,310.00	<b>12152</b>	\$1,205.00	<b>12290</b>	\$1,175.00	\$520.00	\$355.00	<b>34645</b>	\$270.00
500g - 1mg	<b>12469</b>	2,110.00	<b>11918</b>	1,675.00	<b>12066</b>	1,635.00	1,060.00	685.00	<b>34645</b>	270.00
500g - 100mg	<b>45964</b>	2,170.00	<b>45965</b>	1,575.00	<b>45966</b>	1,495.00	760.00	515.00	<b>34645</b>	270.00
500g - 1g	<b>12472</b>	1,425.00	<b>11921</b>	1,310.00	<b>12069</b>	1,275.00	610.00	395.00	<b>34645</b>	270.00
500g - 1g*	<b>11891</b>	1,425.00	<b>12151</b>	1,310.00	<b>12289</b>	1,275.00	610.00	395.00	<b>34645</b>	270.00
500g - 100g	<b>45968</b>	1,010.00	<b>45969</b>	925.00	<b>45970</b>	905.00	310.00	155.00	<b>34645</b>	270.00

**CLASS 4**

**OPTIONAL**

**REPLACEMENT CASES**

Set Size	Part #	Price	Traceable Certificate	Part #	Price
300g - 1g	<b>12393</b>	\$1,075.00	\$270.00	<b>34645</b>	\$270.00
500g - 1mg	<b>12212</b>	1,500.00	575.00	<b>34645</b>	270.00
500g - 100mg	<b>45967</b>	1,335.00	360.00	<b>34645</b>	270.00
500g - 1g	<b>12215</b>	1,175.00	300.00	<b>34645</b>	270.00
500g - 1g*	<b>12392</b>	1,175.00	300.00	<b>34645</b>	270.00
500g - 100g	<b>45971</b>	775.00	120.00	<b>34645</b>	270.00

\* 5-2-2-1 Configuration



Set includes lifting device and gloves

# Metric Sets

Range: 300g and 500g

## WEIGHT SET CONTENTS

300g - 1g	500g - 1mg	500g - 100mg	500g - 1g	500g - 1g*	500g - 100g
1 - 300g	1 - 500g	1 - 500g	1 - 500g	1 - 500g	1 - 500g
1 - 200g	1 - 300g	1 - 300g	1 - 300g	2 - 200g	1 - 300g
1 - 100g	1 - 200g	1 - 200g	1 - 200g	1 - 100g	1 - 200g
1 - 50g	1 - 100g	1 - 100g	1 - 100g	1 - 50g	1 - 100g
1 - 30g	1 - 50g	1 - 50g	1 - 50g	2 - 20g	
1 - 20g	1 - 30g	1 - 30g	1 - 30g	1 - 10g	
1 - 10g	1 - 20g	1 - 20g	1 - 20g	1 - 5g	
1 - 5g	1 - 10g	1 - 10g	1 - 10g	2 - 2g	
1 - 3g	1 - 5g	1 - 5g	1 - 5g	1 - 1g	
1 - 2g	1 - 3g	1 - 3g	1 - 3g		
1 - 1g	1 - 2g	1 - 2g	1 - 2g		
	1 - 1g	1 - 1g	1 - 1g		
	1 - 500mg	1 - 500mg			
	1 - 300mg	1 - 300mg			
	1 - 200mg	1 - 200mg			
	1 - 100mg	1 - 100mg			
	1 - 50mg				
	1 - 30mg				
	1 - 20mg				
	1 - 10mg				
	1 - 5mg				
	1 - 3mg				
	1 - 2mg				
	1 - 1mg				

### Piece Count

11	24	16	12	12	4
----	----	----	----	----	---

### Total Weight

721g	1.222221kg	1.2221kg	1.221kg	1.10kg	1.1kg
Part #	Part #	Part #	Part #	Part #	Part #
-	45923-Class 0	45924-class 0	45925-Class 0	-	45926-Class 0
11892-Class 1	12469-Class 1	45964-Class 1	12472-Class 1	11891-Class 1	45968-Class 1
12152-Class 2	11918-Class 2	45965-Class 2	11921-Class 2	12151-Class 2	45969-Class 2
12290-Class 3	12066-Class 3	45966-Class 3	12069-Class 3	12289-Class 3	45970-Class 3
12393-Class 4	12212-Class 4	45967-Class 4	12215-Class 4	12392-Class 4	45971-Class 4

\* 5-2-2-1 Configuration

### CASE INSERT CLASS 0

Size	Part #	Price
500g - 1mg	49500	\$210.00
500g - 100g	49501	165.00

### CASE INSERT CLASS 1 - 4

Size	Part #	Price
300g - 1g	11586	\$160.00
500g - 1mg	11602	160.00
500g - 1g*	11585	160.00

### ADDITIONAL ACCESSORIES

Part #	Description	Price
36092	Statement of Accuracy	\$45.00
11714	Weight gloves, white cotton	5.00
11711	Tweezer	3.00
152414	Premium tweezer	35.00
25836	Serial number	15.00
11755	Leaf weight cover	35.00
50035	Weight forceps, plastic	35.00
11747	Lifter bar	15.00

# Metric Sets

Range: 1 kg

TEST WEIGHTS

### CLASS 0\*\*

Set Size	Part #	Price	REPLACEMENT CASES	
			Part #	Price
1 kg - 1 mg	<b>45919</b>	\$5,385.00	<b>50437</b>	\$1,480.00
1 kg - 100 mg	<b>45920</b>	4,445.00	<b>50437</b>	1,480.00
1 kg - 1 g	<b>45921</b>	3,740.00	<b>50437</b>	1,480.00
1 kg - 100 g	<b>45922</b>	2,725.00	<b>50437</b>	1,480.00

\*\* Calibration Report included, Statement of Accuracy not available Class 0

### CLASS 1

Set Size	Part #	Price
1 kg - 1 mg	<b>12473</b>	\$2,570.00
1 kg - 100 mg	<b>45972</b>	2,525.00
1 kg - 1 g	<b>12476</b>	2,300.00
1 kg - 1 g*	<b>11889*</b>	2,300.00
1 kg - 100 g	<b>45976</b>	2,070.00

### CLASS 2

Part #	Price	Part #	Price
<b>11922</b>	\$2,360.00	<b>12070</b>	\$2,345.00
<b>45973</b>	2,345.00	<b>45974</b>	2,300.00
<b>11925</b>	2,200.00	<b>12073</b>	2,100.00
<b>12149*</b>	2,200.00	<b>12288*</b>	2,100.00
<b>45977</b>	2,030.00	<b>45978</b>	1,990.00

### CLASS 3

OPTIONAL Calibration Report	OPTIONAL Mass Value Certificate
\$1,150.00	\$725.00
850.00	505.00
700.00	435.00
700.00	435.00
400.00	195.00

### REPLACEMENT CASES

Part #	Price
<b>11603</b>	\$1,480.00
<b>11603</b>	1,480.00
<b>11603</b>	1,480.00
<b>11584</b>	1,285.00
<b>11603</b>	1,480.00

### CLASS 4

Set Size	Part #	Price
1 kg - 1 mg	<b>12216</b>	\$2,135.00
1 kg - 100 mg	<b>45975</b>	2,100.00
1 kg - 1 g	<b>12219</b>	2,055.00
1 kg - 1 g*	<b>12391*</b>	1,990.00
1 kg - 100 g	<b>45979</b>	1,765.00

### OPTIONAL Traceable Certificate

\$600.00
425.00
335.00
335.00
150.00

### REPLACEMENT CASES

Part #	Price
<b>11603</b>	\$1,480.00
<b>11603</b>	1,480.00
<b>11603</b>	1,480.00
<b>11605</b>	1,285.00
<b>11603</b>	1,480.00

\* 5-2-2-1 Configuration

www.ricelake.com | Phone: 800-472-6703

RICELAKE

878



Set includes lifting device and gloves

# Metric Sets

Range: 1 kg

## WEIGHT SET CONTENTS

1 kg - 1 mg	1 kg - 100mg	1 kg - 1 g	1 kg - 1 g*	1 kg - 100g
1 - 1kg	1 - 1 kg	1 - 1 kg	1 - 1 kg	1 - 1 kg
1 - 500g	1 - 500g	1 - 500g	1 - 500g	1 - 500g
1 - 300g	1 - 300g	1 - 300g	2 - 200g	1 - 300g
1 - 200g	1 - 200g	1 - 200g	1 - 100g	1 - 200g
1 - 100g	1 - 100g	1 - 100g	1 - 50g	1 - 100g
1 - 50g	1 - 50g	1 - 50g	2 - 20g	
1 - 30g	1 - 30g	1 - 30g	1 - 10g	
1 - 20g	1 - 20g	1 - 20g	1 - 5g	
1 - 10g	1 - 10g	1 - 10g	2 - 2g	
1 - 5g	1 - 5g	1 - 5g	1 - 1g	
1 - 3g	1 - 3g	1 - 3g		
1 - 2g	1 - 2g	1 - 2g		
1 - 1g	1 - 1g	1 - 1g		
1 - 500mg	1 - 500mg			
1 - 300mg	1 - 300mg			
1 - 200mg	1 - 200mg			
1 - 100mg	1 - 100mg			
1 - 50mg				
1 - 30mg				
1 - 20mg				
1 - 10mg				
1 - 5mg				
1 - 3mg				
1 - 2mg				
1 - 1mg				
<b>Piece Count</b>				
25	17	13	13	5
<b>Total Weight</b>				
2.222221 kg	2.2221 kg	2.221 kg	2.11 kg	2.1 kg
Part #	Part #	Part #	Part #	Part #
<b>45919-Class 0</b>	<b>45920-Class 0</b>	<b>45921-Class 0</b>	-	<b>45922-Class 0</b>
<b>12473-Class 1</b>	<b>45972-Class 1</b>	<b>12476-Class 1</b>	<b>11889-Class 1</b>	<b>45976-Class 1</b>
<b>11922-Class 2</b>	<b>45973-Class 2</b>	<b>11925-Class 2</b>	<b>12149-Class 2</b>	<b>45977-Class 2</b>
<b>12070-Class 3</b>	<b>45974-Class 3</b>	<b>12073-Class 3</b>	<b>12288-Class 3</b>	<b>45978-Class 3</b>
<b>12216-Class 4</b>	<b>45975-Class 4</b>	<b>12219-Class 4</b>	<b>12391-Class 4</b>	<b>45979-Class 4</b>

\* 5-2-2-1 Configuration

### SECONDARY CASE CLASS 1, 2, 3 AND 4

Size	Part #	Price
100g - 1 mg	<b>11596</b>	\$145.00
100g - 1 mg*	<b>11588</b>	145.00

### SECONDARY CASE CLASS 0

Size	Part #	Price
100g - 1 mg	<b>49503</b>	\$200.00

### CASE INSERT CLASSES 1-4

Size	Part #	Price
100g	<b>46380</b>	\$95.00

### ADDITIONAL ACCESSORIES

Part #	Description	Price
<b>36092</b>	Statement of Accuracy	\$45.00
<b>11714</b>	Weight gloves, white cotton	5.00
<b>11711</b>	Tweezer	3.00
<b>152414</b>	Premium tweezer	35.00
<b>25836</b>	Serial number	15.00
<b>11755</b>	Leaf weight cover	35.00
<b>50035</b>	Weight forceps, plastic	35.00
<b>11747</b>	Lifter bar	15.00
<b>50000</b>	Tong Assembly, Class 0	60.00

# Metric Sets

Range: 2 kg

TEST WEIGHTS

### CLASS 0\*\*

Set Size	Part #	Price	Part #	Price
2 kg - 1 mg	<b>45915</b>	\$6,890.00	<b>50439</b>	\$1,505.00
(2) 2 kg - 1 mg*	<b>87043</b>	8,255.00	<b>84474</b>	1,595.00
(2) 2 kg - 10 mg*	<b>87042</b>	7,820.00	<b>84474</b>	1,595.00
2 kg - 100 mg	<b>45916</b>	6,615.00	<b>50439</b>	1,505.00
(2) 2 kg - 100 mg	<b>87041</b>	7,300.00	<b>84474</b>	1,595.00
2 kg - 1 g	<b>45917</b>	4,960.00	<b>50439</b>	1,505.00
(2) 2 kg x 1 g	<b>87044</b>	6,400.00	<b>84474</b>	1,595.00
2 kg - 100 g	<b>45918</b>	4,000.00	<b>50438</b>	1,505.00

### REPLACEMENT CASES

\*\* Calibration Report included, Statement of Accuracy not available for Class 0

### CLASS 1

Set Size	Part #	Price
2 kg - 1 mg	<b>12477</b>	\$3,305.00
(2) 2 kg x 1 mg*	<b>87069</b>	3,685.00
(2) 2 kg x 10 mg*	<b>87065</b>	3,625.00
2 kg - 100 mg	<b>45980</b>	3,520.00
(2) 2 kg - 100 mg*	<b>87061</b>	3,595.00
2 kg - 1 g	<b>12480</b>	2,795.00
2 kg - 1 g*	<b>11888</b>	2,795.00
(2) 2 kg - 1 g*	<b>87073</b>	3,435.00
2 kg - 100 g	<b>45984</b>	2,700.00

### CLASS 2

Part #	Price
<b>11926</b>	\$2,945.00
<b>87070</b>	3,550.00
<b>87066</b>	3,300.00
<b>45981</b>	3,090.00
<b>87062</b>	3,220.00
<b>11929</b>	2,630.00
<b>12148</b>	2,630.00
<b>87074</b>	3,145.00
<b>45985</b>	2,580.00

### CLASS 3

Part #	Price
<b>12074</b>	\$2,895.00
<b>87071</b>	3,425.00
<b>87067</b>	3,160.00
<b>45982</b>	3,020.00
<b>87063</b>	3,085.00
<b>12077</b>	2,575.00
<b>12287</b>	2,575.00
<b>87075</b>	3,075.00
<b>45986</b>	2,420.00

### OPTIONAL

Calibration Report	Mass Value Certificate
\$1,250.00	\$850.00
1,360.00	910.00
1,210.00	790.00
950.00	610.00
1,060.00	670.00
800.00	490.00
800.00	490.00
910.00	550.00
500.00	250.00

### OPTIONAL

Calibration Report	Mass Value Certificate
\$1,250.00	\$850.00
1,360.00	910.00
1,210.00	790.00
950.00	610.00
1,060.00	670.00
800.00	490.00
800.00	490.00
910.00	550.00
500.00	250.00

### REPLACEMENT CASES

Part #	Price
<b>11604</b>	\$1,285.00
<b>84463</b>	1,295.00
<b>84463</b>	1,295.00
<b>11604</b>	1,285.00
<b>84463</b>	1,295.00
<b>11604</b>	1,285.00
<b>11583</b>	1,480.00
<b>84463</b>	1,295.00
<b>11604</b>	1,285.00

### CLASS 4

Set Size	Part #	Price
2 kg - 1 mg	<b>12220</b>	\$2,580.00
(2) 2 kg x 1 mg*	<b>87072</b>	3,160.00
(2) 2 kg x 10 mg*	<b>87068</b>	2,885.00
2 kg - 100 mg	<b>45983</b>	3,000.00
(2) 2 kg - 100 mg*	<b>87064</b>	2,855.00
2 kg - 1 g	<b>12223</b>	2,475.00
2 kg - 1 g*	<b>12390</b>	2,475.00
(2) 2 kg - 1 g*	<b>87076</b>	2,680.00
2 kg - 100 g	<b>45987</b>	2,310.00

### OPTIONAL

Traceable Certificate
\$610.00
700.00
610.00
470.00
520.00
380.00
380.00
430.00
200.00

### REPLACEMENT CASES

Part #	Price
<b>11604</b>	\$1,285.00
<b>84463</b>	1,295.00
<b>84463</b>	1,295.00
<b>11604</b>	1,285.00
<b>84463</b>	1,295.00
<b>11604</b>	1,285.00
<b>11583</b>	1,480.00
<b>84463</b>	1,295.00
<b>11604</b>	1,285.00

\* 5-2-2-1 Configuration



Set includes lifting device and gloves

www.ricelake.com | Phone: 800-472-6703

RICELAKE

# Metric Sets

Range: 2 kg

## WEIGHT SET CONTENTS

2kg - 1mg	(2) 2kg - 1mg*	(2) 2kg - 10mg*	2kg - 100mg	(2) 2kg - 100mg*	2kg - 1g	2kg - 1g*	(2) 2kg - 1g*	2kg - 100g
1 - 2kg	2 - 2kg	2 - 2kg	1 - 2kg	2 - 2kg	1 - 2kg	1 - 2kg	2 - 2kg	1 - 2kg
1 - 1kg	1 - 1kg	1 - 1kg	1 - 1kg	1 - 1kg	1 - 1kg	1 - 1kg	1 - 1kg	1 - 1kg
1 - 500g	1 - 500g	1 - 500g	1 - 500g	1 - 500g	1 - 500g	1 - 500g	1 - 500g	1 - 500g
1 - 300g	2 - 200g	2 - 200g	1 - 300g	2 - 200g	1 - 300g	2 - 200g	2 - 200g	1 - 300g
1 - 200g	1 - 100g	1 - 100g	1 - 200g	1 - 100g	1 - 200g	1 - 100g	1 - 100g	1 - 200g
1 - 100g	1 - 50g	1 - 50g	1 - 100g	1 - 50g	1 - 100g	1 - 50g	1 - 50g	1 - 100g
1 - 50g	2 - 20g	2 - 20g	1 - 50g	2 - 20g	1 - 50g	2 - 20g	2 - 20g	
1 - 30g	1 - 10g	1 - 10g	1 - 30g	1 - 10g	1 - 30g	1 - 10g	1 - 10g	
1 - 20g	1 - 5g	1 - 5g	1 - 20g	1 - 5g	1 - 20g	1 - 5g	1 - 5g	
1 - 10g	2 - 2g	2 - 2g	1 - 10g	2 - 2g	1 - 10g	2 - 2g	2 - 2g	
1 - 5g	1 - 1g	1 - 1g	1 - 5g	1 - 1g	1 - 5g	1 - 1g	1 - 1g	
1 - 3g	1 - 500mg	1 - 500mg	1 - 3g	1 - 500mg	1 - 3g			
1 - 2g	2 - 200mg	2 - 200mg	1 - 2g	2 - 200mg	1 - 2g			
1 - 1g	1 - 100mg	1 - 100mg	1 - 1g	1 - 100mg	1 - 1g			
1 - 500mg	1 - 50mg	1 - 50mg	1 - 500mg					
1 - 300mg	2 - 20mg	2 - 20mg	1 - 300mg					
1 - 200mg	1 - 10mg	1 - 10mg	1 - 200mg					
1 - 100mg	1 - 5mg		1 - 100mg					
1 - 50mg	2 - 2mg							
1 - 30mg	1 - 1mg							
1 - 20mg								
1 - 10mg								
1 - 5mg								
1 - 3mg								
1 - 2mg								
1 - 1mg								

### Piece Count

26	27	23	18	19	14	14	18	6
----	----	----	----	----	----	----	----	---

### Total Weight

4.222221 kg	6.222221 kg	6.22kg	4.2221 kg	6.2221 kg	4.11 kg	4.11 kg	6.221 kg	4.1 kg
Part #	Part #	Part #	Part #	Part #	Part #	Part #	Part #	Part #
45915-Class 0	87043-Class 0	87042-Class 0	45916-Class 0	87041-Class 0	45917-Class 0	-	87044-Class 0	45918-Class 0
12477-Class 1	87069-Class 1	87065-Class 1	45980-Class 1	87061-Class 1	12480-Class 1	11888-Class 1	87073-Class 1	45984-Class 1
11926-Class 2	87070-Class 2	87066-Class 2	45981-Class 2	87062-Class 2	11929-Class 2	12148-Class 2	87074-Class 2	45985-Class 2
12074-Class 3	87071-Class 3	87067-Class 3	45982-Class 3	87063-Class 3	12077-Class 3	12287-Class 3	87075-Class 3	45986-Class 3
12220-Class 4	87072-Class 4	87068-Class 4	45983-Class 4	87064-Class 4	12223-Class 4	12390-Class 4	87076-Class 4	45987-Class 4

\* 5-2-2-1 Configuration

### SECONDARY CASE CLASS 0

Size	Part #	Price
100g - 1mg*	34697	\$180.00
100g - 1mg	49503	200.00

### SECONDARY CASE CLASSES 1 - 4

Size	Part #	Price
100g - 1mg*	11588	\$145.00
100g - 1mg	11596	145.00

### CASE INSERT (WOODEN)

Size	Part #	Price
100g	46380	\$95.00

### ADDITIONAL ACCESSORIES

Part #	Description	Price
36092	Statement of Accuracy	\$45.00
11714	Weight gloves, white cotton	5.00
11711	Tweezer	3.00
152414	Premium tweezer	35.00
25836	Serial number	15.00
11755	Leaf weight cover	35.00
50035	Weight forceps, plastic	35.00
11747	Lifter bar	15.00
11712	Lifter bar, large handle	60.00
50000	Tong Assembly, Class 0	60.00
50037	Lifter (Class 0 and OIML 2kg and 5kg)	45.00

# Metric Sets

Range: 3 kg and 5 kg

TEST WEIGHTS

### CLASS 0\*\*

Set Size	Part #	Price	Part #	Price
5kg - 1 mg	<b>45910</b>	\$9,345.00	<b>49495</b>	\$1,505.00
5kg - 100mg	<b>45911</b>	8,745.00	<b>49495</b>	1,505.00
5kg - 1 g	<b>45912</b>	7,655.00	<b>49495</b>	1,505.00
5kg - 100g	<b>45913</b>	6,435.00	<b>50440</b>	1,445.00

### REPLACEMENT CASES

\*\* Calibration Report included, Statement of Accuracy not available for Class 0

### CLASS 1

Set Size	Part #	Price
3kg - 1 g	<b>11887</b>	\$3,660.00
5kg - 1 mg	<b>12481</b>	4,880.00
5kg - 1 mg*	<b>114050</b>	4,880.00
5kg - 100mg	<b>45988</b>	4,610.00
5kg - 1 g	<b>12484</b>	4,330.00
5kg - 1 g *	<b>11886</b>	4,330.00
5kg - 100g	<b>45992</b>	4,000.00

### CLASS 2

Part #	Price
<b>12147</b>	\$3,120.00
<b>11930</b>	4,315.00
<b>114051</b>	4,315.00
<b>45989</b>	4,290.00
<b>11933</b>	3,965.00
<b>12146</b>	3,965.00
<b>45993</b>	3,630.00

### CLASS 3

Part #	Price
<b>12286</b>	\$3,110.00
<b>12078</b>	4,250.00
<b>114052</b>	4,250.00
<b>45990</b>	4,120.00
<b>12081</b>	3,935.00
<b>12285</b>	3,935.00
<b>45994</b>	3,605.00

### OPTIONAL

Calibration Report	Price
	\$910.00
	1,330.00
	1,330.00
	1,165.00
	1,015.00
	1,015.00
	715.00

### OPTIONAL

Mass Value Certificate	Price
	\$550.00
	800.00
	800.00
	725.00
	605.00
	605.00
	365.00

### REPLACEMENT CASES

Part #	Price
<b>11582</b>	\$1,285.00
<b>11605</b>	1,285.00
<b>11581</b>	1,285.00
<b>11605</b>	1,285.00
<b>11605</b>	1,285.00
<b>11581</b>	1,285.00
<b>11605</b>	1,285.00

### CLASS 4

Set Size	Part #	Price
3kg - 1 g	<b>12389</b>	\$2,785.00
5kg - 1 mg	<b>12224</b>	3,840.00
5kg - 1 mg*	<b>114053</b>	3,840.00
5kg - 100mg	<b>45991</b>	3,735.00
5kg - 1 g	<b>12227</b>	3,405.00
5kg - 1 g*	<b>12388</b>	3,405.00
5kg - 100g	<b>45995</b>	3,115.00

### OPTIONAL

Traceable Certificate	Price
	\$425.00
	740.00
	740.00
	560.00
	470.00
	470.00
	290.00

### REPLACEMENT CASES

Part #	Price
<b>11582</b>	\$1,285.00
<b>11605</b>	1,285.00
<b>11581</b>	1,285.00
<b>11605</b>	1,285.00
<b>11605</b>	1,285.00
<b>11581</b>	1,285.00
<b>11605</b>	1,285.00

\* 5-2-2-1 Configuration

www.ricelake.com | Phone: 800-472-6703

RICELAKE



Set includes lifting device and gloves



# Metric Sets

Range: 3kg and 5kg

## WEIGHT SET CONTENTS

3kg - 1g	5kg - 1mg	5kg - 1mg*	5kg - 100mg	5kg - 1g	5kg - 1g *	5kg - 100g
1 - 3kg	1 - 5kg	1 - 5kg	1 - 5kg	1 - 5kg	1 - 5kg	1 - 5kg
1 - 2kg	1 - 3kg	2 - 2kg	1 - 3kg	1 - 3kg	2 - 2kg	1 - 3kg
1 - 1kg	1 - 2kg	1 - 1kg	1 - 2kg	1 - 2kg	1 - 1kg	1 - 2kg
1 - 500g	1 - 1kg	1 - 500g	1 - 1kg	1 - 1kg	1 - 500g	1 - 1kg
1 - 300g	1 - 500g	2 - 200g	1 - 500g	1 - 500g	2 - 200g	1 - 500g
1 - 200g	1 - 300g	1 - 100g	1 - 300g	1 - 300g	1 - 100g	1 - 300g
1 - 100g	1 - 200g	1 - 50g	1 - 200g	1 - 200g	1 - 50g	1 - 200g
1 - 50g	1 - 100g	2 - 20g	1 - 100g	1 - 100g	2 - 20g	1 - 100g
1 - 30g	1 - 50g	1 - 10g	1 - 50g	1 - 50g	1 - 10g	
1 - 20g	1 - 30g	1 - 5g	1 - 30g	1 - 30g	1 - 5g	
1 - 10g	1 - 20g	2 - 2g	1 - 20g	1 - 20g	2 - 2g	
1 - 5g	1 - 10g	1 - 1g	1 - 10g	1 - 10g	1 - 1g	
1 - 3g	1 - 5g	1 - 500mg	1 - 5g	1 - 5g		
1 - 2g	1 - 3g	2 - 200mg	1 - 3g	1 - 3g		
1 - 1g	1 - 2g	1 - 100mg	1 - 2g	1 - 2g		
	1 - 1g	1 - 50mg	1 - 1g	1 - 1g		
	1 - 500mg	2 - 20mg	1 - 500mg			
	1 - 300mg	1 - 10mg	1 - 300mg			
	1 - 200mg	1 - 5mg	1 - 200mg			
	1 - 100mg	2 - 2mg	1 - 100mg			
	1 - 50mg	1 - 1mg				
	1 - 30mg					
	1 - 20mg					
	1 - 10mg					
	1 - 5mg					
	1 - 3mg					
	1 - 2mg					
	1 - 1mg	-				

**Piece Count**

15	28	28	20	16	16	8
----	----	----	----	----	----	---

**Total Weight**

7.221 kg	12.222221 kg	12.23 kg	12.22 kg	12.221 kg	11.110 kg	12.1 kg
Part #	Part #	Part #	Part #	Part #	Part #	Part #
-	45910-Class 0	-	45911-Class 0	45912-Class 0	-	45913-Class 0
11887-Class 1	12481-Class 1	114050-Class 1	45988-Class 1	12484-Class 1	11886-Class 1	45992-Class 1
12147-Class 2	11930-Class 2	114051-Class 2	45989-Class 2	11933-Class 2	12146-Class 2	45993-Class 2
12286-Class 3	12078-Class 3	114052-Class 3	45990-Class 3	12081-Class 3	12285-Class 3	45994-Class 3
12389-Class 4	12224-Class 4	114053-Class 4	45991-Class 4	12227-Class 4	12388-Class 4	45995-Class 4

\* 5-2-2-1 Configuration

### SECONDARY CASE CLASS 0

Size	Part #	Price
100g - 1mg	49503	\$200.00

### SECONDARY CASE CLASSES 1 - 4

Size	Part #	Price
100g - 1mg*	11588	\$145.00
100g - 1mg	11596	145.00

### CASE INSERT (WOODEN)

Size	Part #	Price
100g	46380	\$95.00

### ADDITIONAL ACCESSORIES

Part #	Description	Price
36092	Statement of Accuracy	\$45.00
11714	Weight gloves, white cotton	5.00
11711	Tweezer	3.00
152414	Premium tweezer	35.00
25836	Serial number	15.00
11755	Leaf weight cover	35.00
50035	Weight forceps, plastic	35.00
11747	Lifter bar	15.00
11712	Lifter bar, large handle	60.00
50000	Tong Assembly, Class 0	60.00
50037	Lifter (Class 0 and OIML 2kg and 5kg)	45.00

# Metric Sets

Range: 10kg

### CLASS 0\*\*

Set Size	Part #	Price	Part #	Price
10kg - 1 mg	<b>45905</b>	\$12,165.00	<b>50442</b>	\$1,755.00
10kg - 100mg	<b>45906</b>	11,545.00	<b>50442</b>	1,755.00
10kg - 1 g	<b>45907</b>	9,855.00	<b>50442</b>	1,755.00
10kg - 100g	<b>45908</b>	9,765.00	<b>50442</b>	1,755.00
10kg - 1 kg	<b>45909</b>	7,695.00	<b>50441</b>	1,480.00

### REPLACEMENT CASES

\*\* Calibration Report included, Statement of Accuracy not available for Class 0

### CLASS 1

Set Size	Part #	Price
10kg - 1 mg	<b>12485</b>	\$6,920.00
10kg - 100mg	<b>45996</b>	6,815.00
10kg - 1 g	<b>12488</b>	6,470.00
10kg - 1 g*	<b>11885</b>	6,470.00
10kg - 100g	<b>46000</b>	6,400.00
10kg - 1 kg	<b>46004</b>	5,955.00

### CLASS 2

Part #	Price
<b>11934</b>	\$6,625.00
<b>45997</b>	6,510.00
<b>11937</b>	6,405.00
<b>12144</b>	6,405.00
<b>46001</b>	6,005.00
<b>46005</b>	5,370.00

### CLASS 3

Part #	Price
<b>12082</b>	\$6,570.00
<b>45998</b>	6,415.00
<b>12085</b>	6,325.00
<b>12283</b>	6,325.00
<b>46002</b>	5,930.00
<b>46006</b>	5,310.00

### OPTIONAL

Calibration Report	Price
	\$1,420.00
	1,265.00
	1,120.00
	1,120.00
	820.00
	510.00

### OPTIONAL

Mass Value Certificate	Price
	\$850.00
	780.00
	660.00
	660.00
	420.00
	270.00

### REPLACEMENT CASES

Part #	Price
<b>11606</b>	\$1,725.00
<b>11606</b>	1,725.00
<b>11606</b>	1,725.00
<b>11580</b>	1,725.00
<b>11606</b>	1,725.00
<b>11606</b>	1,725.00

### CLASS 4

Set Size	Part #	Price
10kg - 1 mg	<b>12228</b>	\$5,890.00
10kg - 100mg	<b>45999</b>	5,785.00
10kg - 1 g	<b>12231</b>	5,705.00
10kg - 1 g*	<b>12386</b>	5,705.00
10kg - 100g	<b>46003</b>	5,345.00
10kg - 1 kg	<b>46007</b>	4,780.00

### OPTIONAL

Traceable Certificate	Price
	\$790.00
	610.00
	515.00
	515.00
	335.00
	240.00

### REPLACEMENT CASES

Part #	Price
<b>11606</b>	\$1,725.00
<b>11606</b>	1,725.00
<b>11606</b>	1,725.00
<b>11580</b>	1,725.00
<b>11606</b>	1,725.00
<b>11606</b>	1,725.00

\* 5-2-2-1 Configuration



Set includes lifting device and gloves

# Metric Sets

Range: 10kg

## WEIGHT SET CONTENTS

10kg - 1 mg	10kg - 100mg	10kg - 1 g	10kg - 1 g*	10kg - 100g	10kg - 1 kg
1 - 10kg	1 - 10kg	1 - 10kg	1 - 10kg	1 - 10kg	1 - 10kg
1 - 5kg	1 - 5kg	1 - 5kg	1 - 5kg	1 - 5kg	1 - 5kg
1 - 3kg	1 - 3kg	1 - 3kg	2 - 2kg	1 - 3kg	1 - 3kg
1 - 2kg	1 - 2kg	1 - 2kg	1 - 1kg	1 - 2kg	1 - 2kg
1 - 1kg	1 - 1kg	1 - 1kg	1 - 500g	1 - 1kg	1 - 1kg
1 - 500g	1 - 500g	1 - 500g	2 - 200g	1 - 500g	
1 - 300g	1 - 300g	1 - 300g	1 - 100g	1 - 300g	
1 - 200g	1 - 200g	1 - 200g	1 - 50g	1 - 200g	
1 - 100g	1 - 100g	1 - 100g	2 - 20g	1 - 100g	
1 - 50g	1 - 50g	1 - 50g	1 - 10g		
1 - 30g	1 - 30g	1 - 30g	1 - 5g		
1 - 20g	1 - 20g	1 - 20g	2 - 2g		
1 - 10g	1 - 10g	1 - 10g	1 - 1g		
1 - 5g	1 - 5g	1 - 5g			
1 - 3g	1 - 3g	1 - 3g			
1 - 2g	1 - 2g	1 - 2g			
1 - 1g	1 - 1g	1 - 1g			
1 - 500mg	1 - 500mg				
1 - 300mg	1 - 300mg				
1 - 200mg	1 - 200mg				
1 - 100mg	1 - 100mg				
1 - 50mg					
1 - 30mg					
1 - 20mg					
1 - 10mg					
1 - 5mg					
1 - 3mg					
1 - 2mg					
1 - 1mg					

### Piece Count

29	21	17	17	9	5
----	----	----	----	---	---

### Total Weight

22.222221 kg	22.2221 kg	22.221 kg	21.11 kg	22.1 kg	21 kg
Part #	Part #	Part #	Part #	Part #	Part #
45905-Class 0	45906-Class 0	45907-Class 0	-	45908-Class 0	45909-Class 0
12485-Class 1	45996-Class 1	12488-Class 1	11885-Class 1	46000-Class 1	46004-Class 1
11934-Class 2	45997-Class 2	11937-Class 2	12144-Class 2	46001-Class 2	46005-Class 2
12082-Class 3	45998-Class 3	12085-Class 3	12283-Class 3	46002-Class 3	46006-Class 3
12278-Class 4	45999-Class 4	12231-Class 4	12386-Class 4	46003-Class 4	46007-Class 4

\* 5-2-2-1 Configuration

## SECONDARY CASE CLASS 0

Size	Part #	Price
100g - 1 mg*	11588	\$145.00
100g - 1 mg	49503	200.00
Insert, 100g	49489	130.00

## SECONDARY CASE CLASSES 1 - 4

Size	Part #	Price
100g - 1 mg*	11588	\$145.00
100g - 1 mg	11596	145.00
Insert, 100g	46380	95.00

## ADDITIONAL ACCESSORIES

Part #	Description	Price
36092	Statement of Accuracy	\$45.00
11714	Weight gloves, white cotton	5.00
11711	Tweezer	3.00
152414	Premium tweezer	35.00
25836	Serial number	15.00
11755	Leaf weight cover	35.00
50035	Weight forceps, plastic	35.00
11747	Lifter bar	15.00
11712	Lifter bar, large handle	60.00
50000	Tong Assembly, Class 0	60.00
50037	Lifter (Class 0 and OIML 2kg and 5kg)	45.00

# Metric Sets

Range: 20kg and 25 kg

### CLASS 0\*\*

Set Size	Part #	Price	REPLACEMENT CASES	
			Part #	Price
20 kg - 1 mg	<b>45900</b>	\$15,420.00	<b>50670</b>	\$1,755.00
20 kg - 100 mg	<b>45901</b>	14,810.00	<b>50670</b>	1,755.00
20 kg - 1 g	<b>45902</b>	13,115.00	<b>50670</b>	1,755.00
20 kg - 100 g	<b>45903</b>	13,020.00	<b>50670</b>	1,755.00
20 kg - 1 kg	<b>45904</b>	11,325.00	<b>50670</b>	1,755.00

\*\* Calibration Report included, Statement of Accuracy not available for Class 0

### CLASS 1

Set Size	Part #	Price
25 kg - 1 g*	<b>11883</b>	\$12,960.00
20 kg - 1 mg	<b>12489</b>	9,520.00
20 kg - 100 mg	<b>46008</b>	9,410.00
20 kg - 1 g	<b>12492</b>	8,830.00
20 kg - 1 g*	<b>11884</b>	8,830.00
20 kg - 100g	<b>46012</b>	8,415.00
20 kg - 1 kg	<b>46016</b>	8,180.00

### CLASS 2

Part #	Price
<b>12140</b>	\$11,680.00
<b>11938</b>	8,630.00
<b>46009</b>	8,505.00
<b>11941</b>	8,410.00
<b>12142</b>	8,410.00
<b>46013</b>	8,010.00
<b>46017</b>	7,380.00

### CLASS 3

Part #	Price
<b>12279</b>	\$11,235.00
<b>12086</b>	8,550.00
<b>46010</b>	8,405.00
<b>12089</b>	8,310.00
<b>12281</b>	8,310.00
<b>46014</b>	7,910.00
<b>46018</b>	7,285.00

### OPTIONAL

Calibration Report
\$1,325.00
1,600.00
1,375.00
1,225.00
1,225.00
925.00
615.00

### OPTIONAL

Mass Value Certificate
\$775.00
975.00
835.00
720.00
720.00
480.00
325.00

### REPLACEMENT CASES

Part #	Price
<b>11578</b>	\$1,725.00
<b>11608</b>	1,725.00
<b>11608</b>	1,725.00
<b>11579</b>	1,725.00
<b>11608</b>	1,725.00
<b>11608</b>	1,725.00
<b>11608</b>	1,725.00

### CLASS 4

Set Size	Part #	Price
25 kg - 1 g*	<b>12382</b>	\$10,510.00
20 kg - 1 mg	<b>12232</b>	7,700.00
20 kg - 100 mg	<b>46011</b>	7,570.00
20 kg - 1 g	<b>12235</b>	7,485.00
20 kg - 1 g*	<b>12384</b>	7,485.00
20 kg - 100g	<b>46015</b>	7,135.00
20 kg - 1 kg	<b>46019</b>	6,560.00

### OPTIONAL

Traceable Certificate
\$560.00
750.00
650.00
580.00
580.00
380.00
260.00

### REPLACEMENT CASES

Part #	Price
<b>11578</b>	\$1,725.00
<b>11608</b>	1,725.00
<b>11608</b>	1,725.00
<b>11579</b>	1,725.00
<b>11608</b>	1,725.00
<b>11608</b>	1,725.00
<b>11608</b>	1,725.00

\* 5-2-2-1 Configuration



Set includes lifting device and gloves

# Metric Sets

Range: 20 kg and 25 kg

## WEIGHT SET CONTENTS

25 kg - 1 g*	20 kg - 1 mg	20 kg - 100 mg	20 kg - 1 g	20 kg - 1 g*	20 kg - 100 g	20 kg - 1 kg
1 - 25 kg	1 - 20 kg	1 - 20 kg	1 - 20 kg	1 - 20 kg	1 - 20 kg	1 - 20 kg
1 - 10 kg	1 - 10 kg	1 - 10 kg	1 - 10 kg	1 - 10 kg	1 - 10 kg	1 - 10 kg
1 - 5 kg	1 - 5 kg	1 - 5 kg	1 - 5 kg	1 - 5 kg	1 - 5 kg	1 - 5 kg
2 - 2 kg	1 - 3 kg	1 - 3 kg	1 - 3 kg	2 - 2 kg	1 - 3 kg	1 - 3 kg
1 - 1 kg	1 - 2 kg	1 - 2 kg	1 - 2 kg	1 - 1 kg	1 - 2 kg	1 - 2 kg
1 - 500 g	1 - 1 kg	1 - 1 kg	1 - 1 kg	1 - 500 g	1 - 1 kg	1 - 1 kg
2 - 200 g	1 - 500 g	1 - 500 g	1 - 500 g	2 - 200 g	1 - 500 g	
1 - 100 g	1 - 300 g	1 - 300 g	1 - 300 g	1 - 100 g	1 - 300 g	
1 - 50 g	1 - 200 g	1 - 200 g	1 - 200 g	1 - 50 g	1 - 200 g	
2 - 20 g	1 - 100 g	1 - 100 g	1 - 100 g	2 - 20 g	1 - 100 g	
1 - 10 g	1 - 50 g	1 - 50 g	1 - 50 g	1 - 10 g		
1 - 5 g	1 - 30 g	1 - 30 g	1 - 30 g	1 - 5 g		
2 - 2 g	1 - 20 g	1 - 20 g	1 - 20 g	2 - 2 g		
1 - 1 g	1 - 10 g	1 - 10 g	1 - 10 g	1 - 1 g		
	1 - 5 g	1 - 5 g	1 - 5 g			
	1 - 3 g	1 - 3 g	1 - 3 g			
	1 - 2 g	1 - 2 g	1 - 2 g			
	1 - 1 g	1 - 1 g	1 - 1 g			
	1 - 500 mg	1 - 500 mg				
	1 - 300 mg	1 - 300 mg				
	1 - 200 mg	1 - 200 mg				
	1 - 100 mg	1 - 100 mg				
	1 - 50 mg					
	1 - 30 mg					
	1 - 20 mg					
	1 - 10 mg					
	1 - 5 mg					
	1 - 3 mg					
	1 - 2 mg					
	1 - 1 mg					

### Piece Count

18	30	22	18	18	10	6
----	----	----	----	----	----	---

### Total Weight

46.11 kg	42.222221 kg	42.22 kg	42.22 kg	41.11 kg	42.1 kg	41 kg
----------	--------------	----------	----------	----------	---------	-------

Part #	Part #	Part #	Part #	Part #	Part #	Part #
-	45900-Class 0	45901-Class 0	45902-Class 0	-	45903-Class 0	45904-Class 0
11883-Class 1	12489-Class 1	46008-Class 1	12492-Class 1	11884-Class 1	46012-Class 1	46016-Class 1
12140-Class 2	11938-Class 2	46009-Class 2	11941-Class 2	12142-Class 2	46013-Class 2	46017-Class 2
12279-Class 3	12086-Class 3	46010-Class 3	12089-Class 3	12281-Class 3	46014-Class 3	46018-Class 3
12382-Class 4	12232-Class 4	46011-Class 4	12235-Class 4	12384-Class 4	46015-Class 4	46019-Class 4

\* 5-2-2-1 Configuration

### SECONDARY CASE CLASS 0

Size	Part #	Price
100g - 1 mg*	11588	\$145.00
100g - 1 mg	49503	200.00
Insert, 100 g	49489	130.00

### SECONDARY CASE CLASSES 1 - 4

Size	Part #	Price
100 g - 1 mg*	11588	\$145.00
100g - 1 mg	11596	145.00
Insert, 100 g	46380	95.00

### ADDITIONAL ACCESSORIES

Part #	Description	Price
36092	Statement of Accuracy	\$45.00
11714	Weight gloves, white cotton	5.00
11711	Tweezer	3.00
152414	Premium tweezer	35.00
25836	Serial number	15.00
11755	Leaf weight cover	35.00
50035	Weight forceps, plastic	35.00
11747	Lifter bar	15.00
11712	Lifter bar, large handle	60.00
50000	Tong assembly, Class 0	60.00
50037	Lifter (Class 0 and OIML 2 kg and 5 kg)	45.00

# Avoirdupois Sets

Range: 50lb through 2lb

CLASS 1			CLASS 2		CLASS 3		OPTIONAL	OPTIONAL	REPLACEMENT CASES	
Set Size	Part #	Price	Part #	Price	Part #	Price	Calibration Report	Mass Value Certificate	Part #	Price
50lb - 1/32oz	<b>11999</b>	\$16,940.00	<b>12145</b>	\$16,760.00	<b>12284</b>	\$16,535.00	\$1,200.00	\$760.00	<b>11589</b>	\$1,725.00
50lb - 0.001lb	<b>119043</b>	16,940.00	<b>119044</b>	16,760.00	<b>119045</b>	16,535.00	1,200.00	760.00	<b>11589</b>	1,725.00
20lb - 1/32oz	<b>11997</b>	8,105.00	<b>12143</b>	8,100.00	<b>12282</b>	8,090.00	900.00	640.00	<b>11590</b>	1,850.00
20lb - 0.001lb	<b>119047</b>	8,105.00	<b>119048</b>	8,100.00	<b>119049</b>	8,090.00	900.00	640.00	<b>11590</b>	1,850.00
10lb - 1/32oz	<b>11995</b>	5,665.00	<b>12141</b>	5,500.00	<b>12280</b>	5,430.00	790.00	570.00	<b>11591</b>	1,480.00
10lb - 0.001lb	<b>119051</b>	5,665.00	<b>119052</b>	5,500.00	<b>119053</b>	5,430.00	790.00	570.00	<b>11591</b>	1,480.00
5lb - 1/32oz	<b>11993</b>	4,315.00	<b>12139</b>	4,165.00	<b>12278</b>	4,110.00	695.00	510.00	<b>11592</b>	1,145.00
5lb - 0.001lb	<b>119055</b>	4,315.00	<b>119056</b>	4,165.00	<b>119057</b>	4,110.00	695.00	510.00	<b>11592</b>	1,145.00
2lb - 1/32oz	<b>11991</b>	2,885.00	<b>12137</b>	2,760.00	<b>12276</b>	2,610.00	525.00	400.00	<b>11593</b>	1,495.00
2lb - 0.001lb	<b>119059</b>	2,885.00	<b>119060</b>	2,760.00	<b>119061</b>	2,610.00	525.00	400.00	<b>11593</b>	1,495.00

CLASS 4			OPTIONAL	REPLACEMENT CASES	
Set Size	Part #	Price	Traceable Certificate	Part #	Price
50lb - 1/32oz	<b>12387</b>	\$16,125.00	\$575.00	<b>11589</b>	\$1,725.00
50lb - 0.001lb	<b>119046</b>	16,125.00	575.00	<b>11589</b>	1,725.00
20lb - 1/32oz	<b>12385</b>	7,440.00	480.00	<b>11590</b>	1,850.00
20lb - 0.001lb	<b>119050</b>	7,440.00	480.00	<b>11590</b>	1,850.00
10lb - 1/32oz	<b>12383</b>	5,330.00	445.00	<b>11591</b>	1,480.00
10lb - 0.001lb	<b>119054</b>	5,330.00	445.00	<b>11591</b>	1,480.00
5lb - 1/32oz	<b>12381</b>	3,720.00	395.00	<b>11592</b>	1,145.00
5lb - 0.001lb	<b>119058</b>	3,720.00	395.00	<b>11592</b>	1,145.00
2lb - 1/32oz	<b>12379</b>	2,415.00	310.00	<b>11593</b>	1,495.00
2lb - 0.001lb	<b>119062</b>	2,415.00	310.00	<b>11593</b>	1,495.00

### SECONDARY CASE

Size	Part #	Price
4oz - 1/32oz	<b>11610</b>	\$250.00

### ADDITIONAL ACCESSORIES

Part #	Description	Price
<b>36092</b>	Statement of Accuracy	\$45.00
<b>11714</b>	Weight gloves, white cotton	5.00
<b>11711</b>	Tweezer	3.00
<b>152414</b>	Premium tweezer	35.00
<b>25836</b>	Serial number	15.00
<b>11758</b>	Leaf weight cover	35.00
<b>50035</b>	Weight forceps, plastic	35.00
<b>11747</b>	Lifter bar	15.00
<b>11712</b>	Lifter bar, large handle	60.00
<b>50000</b>	Tong assembly, Class 0	60.00
<b>50037</b>	Lifter (Class 0 and OIML 2kg and 5kg)	45.00



Set includes lifting device and gloves

# Avoirdupois Sets

Range: 50lb through 2lb

## WEIGHT SET CONTENTS

50 lb - 1/32 oz	50 lb - 0.001 lb	20 lb - 1/32 oz	20 lb - 0.001 lb	10 lb - 1/32 oz	10 lb - 0.001 lb	5 lb - 1/32 oz	5 lb - 0.001 lb	2 lb - 1/32 oz	2 lb - 0.001 lb
1 - 50lb	1 - 50lb	1 - 20lb	1 - 20lb	1 - 10lb	1 - 10lb	1 - 5lb	1 - 5lb	1 - 2lb	1 - 2lb
1 - 30lb	1 - 30lb	1 - 10lb	1 - 10lb	1 - 5lb	1 - 5lb	1 - 3lb	1 - 3lb	1 - 1lb	1 - 1lb
1 - 20lb	1 - 20lb	1 - 5lb	1 - 5lb	1 - 3lb	1 - 3lb	1 - 2lb	1 - 2lb	1 - 8oz	1 - .5lb
1 - 10lb	1 - 10lb	1 - 3lb	1 - 3lb	1 - 2lb	1 - 2lb	1 - 1lb	1 - 1lb	1 - 4oz	1 - 0.3lb
1 - 5lb	1 - 5lb	1 - 2lb	1 - 2lb	1 - 1lb	1 - 1lb	1 - 8oz	1 - .5lb	1 - 2oz	1 - 0.2lb
1 - 3lb	1 - 3lb	1 - 1lb	1 - 1lb	1 - 8oz	1 - .5lb	1 - 4oz	1 - 0.3lb	1 - 1oz	1 - 0.1lb
1 - 2lb	1 - 2lb	1 - 8oz	1 - .5lb	1 - 4oz	1 - 0.3lb	1 - 2oz	1 - 0.2lb	1 - 1/2oz	1 - 0.05lb
1 - 1lb	1 - 1lb	1 - 4oz	1 - 0.3lb	1 - 2oz	1 - 0.2lb	1 - 1oz	1 - 0.1lb	1 - 1/4oz	1 - 0.03lb
1 - 8oz	1 - .5lb	1 - 2oz	1 - 0.2lb	1 - 1oz	1 - 0.1lb	1 - 1/2oz	1 - 0.05lb	1 - 1/8oz	1 - 0.02lb
1 - 4oz	1 - 0.3lb	1 - 1oz	1 - 0.1lb	1 - 1/2oz	1 - 0.05lb	1 - 1/4oz	1 - 0.03lb	1 - 1/16oz	1 - 0.01lb
1 - 2oz	1 - 0.2lb	1 - 1/2oz	1 - 0.05lb	1 - 1/4oz	1 - 0.03lb	1 - 1/8oz	1 - 0.02lb	2 - 1/32 oz	1 - 0.005lb
1 - 1oz	1 - 0.1lb	1 - 1/4oz	1 - 0.03lb	1 - 1/8oz	1 - 0.02lb	1 - 1/16oz	1 - 0.01lb		1 - 0.003lb
1 - 1/2oz	1 - 0.05lb	1 - 1/8oz	1 - 0.02lb	1 - 1/16oz	1 - 0.01lb	2 - 1/32oz	1 - 0.005lb		1 - 0.002lb
1 - 1/4oz	1 - 0.03lb	1 - 1/16oz	1 - 0.01lb	2 - 1/32oz	1 - 0.005lb		1 - 0.003lb		1 - 0.001lb
1 - 1/8oz	1 - 0.02lb	2 - 1/32oz	1 - 0.005lb		1 - 0.003lb		1 - 0.002lb		
1 - 1/16oz	1 - 0.01lb		1 - 0.003lb		1 - 0.002lb		1 - 0.001lb		
2 - 1/32oz	1 - 0.005lb		1 - 0.002lb		1 - 0.001lb				
	1 - 0.003lb		1 - 0.001lb						
	1 - 0.002lb								
	1 - 0.001lb								

### Piece Count

18	20	16	18	15	17	14	16	12	14
----	----	----	----	----	----	----	----	----	----

### Total Weight

122lb	122lb	42lb	42lb	22lb	22lb	12lb	12lb	4lb	4lb
Part #	Part #	Part #	Part #	Part #	Part #	Part #	Part #	Part #	Part #
11999-Class 1	119043-Class 1	11997-Class 1	119047-Class 1	11995-Class 1	119051-Class 1	11993-Class 1	119055-Class 1	11991-Class 1	119059-Class 1
12145-Class 2	119044-Class 2	12143-Class 2	119048-Class 2	12141-Class 2	119052-Class 2	12139-Class 2	119056-Class 2	12137-Class 2	119060-Class 2
12284-Class 3	119045-Class 3	12282-Class 3	119049-Class 3	12280-Class 3	119053-Class 3	12278-Class 3	119057-Class 3	12276-Class 3	119061-Class 3
12387-Class 4	119046-Class 4	12385-Class 4	119050-Class 4	12383-Class 4	119054-Class 4	12381-Class 4	119058-Class 4	12379-Class 4	119062-Class 4

## STAINLESS STEEL - OIML

### Applications:

- Density measurement
- Tolerance checking
- Mass standards
- OIML guidelines for balance and scale verification

### Styles Available:

- Type 1, one-piece construction, no added adjusting material

### Product Configuration:

- Individual weight kits
- Weight sets

### Weight Set Configuration:

- Weight kits - case (or vial), glove and weight
- Weight sets - case (additional small case or vial if required), handling equipment and weights
- Set configuration 5-2-2-1 (1) 50g, (2) 20g, and (1) 10g
- Appropriate lifter, tweezer and/or glove
- OIML weights sets larger than 500g include a hardwood case with velvet-lined pockets
- Weight sets with the largest weight of 500g include a precision-machined polyvinyl, crush resistant case

### Features:

- Nominal value marked on weights
- Serial numbers applied to case (Weights may be marked with symbol)
- Density is approximately 7.95g/cm<sup>3</sup>
- OIML E1, E2, F1, F2 polish finish
- OIML M1 and M2 satin finish
- E1, E2, F1, F2 and M1 weights include protective case
- Weights manufactured International Recommendation, OIML R 111 specifications
- E1 and E2 supplied with calibration report per OIML R111



Precision Laboratory - OIML  
Metric Kits

CLASS E1*			CLASS E2*			
	Weight	Kit Part #	Kit Price	Weight	Kit Part #	Kit Price
Cylindrical	-	-	-	20kg	<b>53850</b>	\$2,640.00
	10kg	<b>36872</b>	\$2,950.00	10kg	<b>36871</b>	2,160.00
	5kg	<b>29785</b>	1,900.00	5kg	<b>29775</b>	1,215.00
	2kg	<b>29784</b>	1,395.00	2kg	<b>29774</b>	765.00
	1kg	<b>29783</b>	940.00	1kg	<b>29773</b>	570.00
	500g	<b>29782</b>	700.00	500g	<b>29772</b>	395.00
	200g	<b>29781</b>	600.00	200g	<b>29771</b>	312.00
	100g	<b>29780</b>	560.00	100g	<b>29770</b>	155.00
	50g	<b>29779</b>	500.00	50g	<b>29769</b>	150.00
	20g	<b>29778</b>	495.00	20g	<b>29768</b>	147.00
	10g	<b>29777</b>	490.00	10g	<b>29767</b>	140.00
	5g	<b>29776</b>	440.00	5g	<b>29766</b>	123.00
	2g	<b>29745</b>	440.00	2g	<b>29743</b>	123.00
	1g	<b>29744</b>	420.00	1g	<b>29742</b>	123.00
Milligram	500mg	<b>29737</b>	240.00	500mg	<b>29731</b>	120.00
	200mg	<b>29736</b>	240.00	200mg	<b>29730</b>	120.00
	100mg	<b>29735</b>	240.00	100mg	<b>29729</b>	120.00
	50mg	<b>29734</b>	240.00	50mg	<b>29728</b>	120.00
	20mg	<b>29733</b>	240.00	20mg	<b>29727</b>	120.00
	10mg	<b>29732</b>	240.00	10mg	<b>29726</b>	120.00
	5mg	<b>29713</b>	240.00	5mg	<b>29710</b>	120.00
	2mg	<b>29712</b>	240.00	2mg	<b>29709</b>	120.00
	1mg	<b>29711</b>	240.00	1mg	<b>29708</b>	120.00



One-piece and Milligram Kits

\*Calibration Report included, Statement of Accuracy not available Class E1 and E2

CLASS F1			CLASS F2		OPTIONAL	OPTIONAL	
	Weight	Kit Part #	Kit Price	Kit Part #	Kit Price	Calibration Report	Mass Value Certificate
Cylindrical	20kg	<b>53654</b>	\$1,950.00	<b>53655</b>	\$1,860.00	\$140.00	\$75.00
	10kg	<b>36870</b>	1,580.00	<b>36869</b>	1,215.00	140.00	75.00
	5kg	<b>29765</b>	945.00	<b>29755</b>	660.00	140.00	75.00
	2kg	<b>29764</b>	555.00	<b>29754</b>	525.00	140.00	75.00
	1kg	<b>29763</b>	390.00	<b>29753</b>	340.00	120.00	55.00
	500g	<b>29762</b>	200.00	<b>29752</b>	185.00	120.00	55.00
	200g	<b>29761</b>	140.00	<b>29751</b>	135.00	120.00	55.00
	100g	<b>29760</b>	100.00	<b>29750</b>	95.00	50.00	40.00
	50g	<b>29759</b>	95.00	<b>29749</b>	85.00	50.00	40.00
	20g	<b>29758</b>	95.00	<b>29748</b>	75.00	50.00	40.00
	10g	<b>29757</b>	95.00	<b>29747</b>	75.00	50.00	40.00
	5g	<b>29756</b>	95.00	<b>29746</b>	75.00	50.00	40.00
	2g	<b>29741</b>	85.00	<b>29739</b>	70.00	50.00	40.00
	1g	<b>29740</b>	75.00	<b>29738</b>	70.00	50.00	40.00
Milligram	500mg	<b>29725</b>	45.00	<b>29719</b>	40.00	50.00	40.00
	200mg	<b>29724</b>	45.00	<b>29718</b>	40.00	50.00	40.00
	100mg	<b>29723</b>	45.00	<b>29717</b>	40.00	50.00	40.00
	50mg	<b>29722</b>	45.00	<b>29716</b>	40.00	50.00	40.00
	20mg	<b>29721</b>	45.00	<b>29715</b>	40.00	50.00	40.00
	10mg	<b>29720</b>	45.00	<b>29714</b>	40.00	50.00	40.00
	5mg	<b>29707</b>	45.00	<b>29704</b>	40.00	50.00	40.00
	2mg	<b>29706</b>	45.00	<b>29703</b>	40.00	50.00	40.00
	1mg	<b>29705</b>	45.00	<b>29702</b>	40.00	50.00	40.00

TEST WEIGHTS

www.ricelake.com | Phone: 800-472-6703

RICE LAKE

Precision Laboratory - OIML  
**Metric Kits and Weights**

TEST WEIGHTS

M1			OPTIONAL	REPLACEMENT CASES	
Weight	Kit Part #	Kit Price	Traceable Certificate	Part #	Price
20kg	<b>156292</b>	\$1,175.00	\$70.00	<b>156290</b>	\$450.00
10kg	<b>156291</b>	1,010.00	70.00	<b>156289</b>	450.00
5kg	<b>116207</b>	455.00	70.00	<b>116202</b>	200.00
2kg	<b>116206</b>	260.00	70.00	<b>116201</b>	60.00
1kg	<b>116205</b>	150.00	50.00	<b>116200</b>	60.00
500g	<b>116204</b>	125.00	50.00	<b>116199</b>	40.00
200g	<b>116203</b>	95.00	50.00	<b>116198</b>	40.00
100g	<b>111927</b>	70.00	35.00	<b>112850</b>	30.00
50g	<b>111928</b>	65.00	35.00	<b>112849</b>	30.00
20g	<b>111929</b>	55.00	35.00	<b>112848</b>	30.00
10g	<b>111930</b>	55.00	35.00	<b>112847</b>	30.00
5g	<b>111931</b>	55.00	35.00	<b>112846</b>	30.00
2g	<b>111932</b>	55.00	35.00	<b>112845</b>	30.00
1g	<b>111933</b>	55.00	35.00	<b>112844</b>	30.00

M2*			OPTIONAL	REPLACEMENT CASES	
Weight	Part #	Price	Traceable Certificate	Part #	Price
5kg	<b>115926</b>	\$220.00	\$70.00	<b>116202</b>	\$200.00
2kg	<b>115925</b>	195.00	70.00	<b>116201</b>	60.00
1kg	<b>115924</b>	95.00	50.00	<b>116200</b>	60.00
500g	<b>115923</b>	85.00	50.00	<b>116199</b>	40.00
200g	<b>115922</b>	75.00	50.00	<b>116198</b>	40.00
100g	<b>111934</b>	60.00	35.00	<b>112850</b>	30.00
50g	<b>111935</b>	55.00	35.00	<b>112849</b>	30.00
20g	<b>111936</b>	55.00	35.00	<b>112848</b>	30.00
10g	<b>111937</b>	55.00	35.00	<b>112847</b>	30.00
5g	<b>111938</b>	55.00	35.00	<b>112846</b>	30.00
2g	<b>111939</b>	55.00	35.00	<b>112845</b>	30.00
1g	<b>111940</b>	55.00	35.00	<b>112844</b>	30.00

\*M2 is sold as individual weight, accessory cases are available.

**ADDITIONAL ACCESSORIES**

Part #	Description	Price
<b>36092</b>	Statement of Accuracy	\$45.00
<b>11714</b>	Weight gloves, white cotton	5.00
<b>152414</b>	Premium tweezer	35.00



M1 and M2 One-piece Design

www.ricelake.com | Phone: 800-472-6703

**RICE LAKE**

# Metric Sets

Range: 500mg-50g

CLASS E1*			CLASS E2*			REPLACEMENT CASES	
Set Size	Part #	Price	Set Size	Part #	Price	Part #	Price
500mg - 1mg	<b>30850</b>	\$1,760.00	500mg - 1mg	<b>30851</b>	\$1,200.00	<b>34699</b>	\$100.00
500mg - 100mg	<b>30854</b>	885.00	500mg - 100mg	<b>30855</b>	760.00	<b>34699</b>	100.00
*Calibration Report included, Statement of Accuracy not available, Class E1 or E2			50g - 1mg	<b>96477</b>	1,800.00	<b>34697</b>	180.00
			50g - 1g	<b>96478</b>	980.00	<b>34697</b>	180.00

CLASS F1			CLASS F2		OPTIONAL		OPTIONAL		REPLACEMENT CASES	
Set Size	Part #	Price	Part #	Price	Calibration Report	Mass Value Certificate	Part #	Price	Part #	Price
500mg - 1mg	<b>30852</b>	\$500.00	<b>30853</b>	\$385.00	\$450.00	\$360.00	<b>34699</b>	\$100.00	<b>34699</b>	\$100.00
500mg - 100mg	<b>30856</b>	365.00	<b>30857</b>	230.00	150.00	120.00	<b>34699</b>	100.00	<b>34697</b>	180.00
50g - 1mg	<b>96479</b>	800.00	<b>96481</b>	750.00	750.00	600.00	<b>34697</b>	180.00	<b>34697</b>	180.00
50g - 1g	<b>96480</b>	475.00	<b>96482</b>	460.00	300.00	240.00	<b>34697</b>	180.00		

CLASS M1*			TRACEABLE REPORT	
Set Size	Part #	Price	Price	
500mg - 1mg	<b>161537</b>	<b>\$365.00</b>	<b>\$270.00</b>	

### WEIGHT SET CONTENTS

500mg - 1mg	500mg - 100mg	50g - 1mg	50g - 1g
1 - 500mg	1 - 500mg	1 - 50g	1 - 50g
2 - 200mg	2 - 200mg	2 - 20g	2 - 20g
1 - 100mg	1 - 100mg	1 - 10g	1 - 10g
1 - 50mg		1 - 5g	1 - 5g
2 - 20mg		2 - 2g	2 - 2g
1 - 10mg		1 - 1g	1 - 1g
1 - 5mg		1 - 500mg	
2 - 2mg		2 - 200mg	
1 - 1mg		1 - 100mg	
		1 - 50mg	
		2 - 20mg	
		1 - 10mg	
		1 - 5mg	
		2 - 2mg	
		1 - 1mg	

Piece Count			
12	4	20	8

Total Weight			
1.11g	1g	111.11g	108g
Part #	Part #	Part #	Part #
<b>30850-Class E1</b>	<b>30854-Class E1</b>	<b>-Class E1</b>	<b>-Class E1</b>
<b>30851-Class E2</b>	<b>30855-Class E2</b>	<b>96477-Class E2</b>	<b>96478-Class E2</b>
<b>30852-Class F1</b>	<b>30856-Class F1</b>	<b>96479-Class F1</b>	<b>96480-Class F1</b>
<b>30853-Class F2</b>	<b>30857-Class F2</b>	<b>96481-Class F2</b>	<b>96482-Class F2</b>
<b>161537-Class M1</b>	-	-	-

### ADDITIONAL ACCESSORIES

Part #	Description	Price
<b>36092</b>	Statement of Accuracy*	\$45.00
<b>11714</b>	Weight gloves, white cotton	5.00
<b>11711</b>	Tweezer	3.00
<b>152414</b>	Premium tweezer	35.00
<b>25836</b>	Serial number	15.00
<b>11755</b>	Leaf weight cover	35.00
<b>50035</b>	Weight forceps, plastic, 200g - 500g	35.00
<b>50000</b>	Tong Assembly, Class 0	60.00
<b>50037</b>	Lifter (Class 0 and OIML 2kg and 5kg)	45.00



Set includes lifting device and gloves

# Metric Sets

Range: 100g

### CLASS E1\*

Set Size	Part #	Price
100g - 1 mg	<b>30838</b>	\$4,320.00
100g - 100mg	<b>30842</b>	3,380.00
100g - 1g	<b>30846</b>	2,810.00

### CLASS E2\*

Set Size	Part #	Price
100g - 1 mg	<b>30839</b>	\$1,985.00
100g - 100mg	<b>30843</b>	1,420.00
100g - 1g	<b>30847</b>	1,065.00

### REPLACEMENT CASES

Part #	Price
<b>34697</b>	\$180.00
<b>34697</b>	180.00
<b>34697</b>	180.00

\*Calibration Report included, Statement of Accuracy not available Class E1 or E2

### CLASS F1

Set Size	Part #	Price
100g - 1 mg	<b>30840</b>	\$865.00
100g - 100mg	<b>30844</b>	770.00
100g - 1g	<b>30848</b>	680.00

### CLASS F2

Part #	Price
<b>30841</b>	\$815.00
<b>30845</b>	680.00
<b>30849</b>	620.00

### OPTIONAL

Calibration Report	Price
	\$790.00
	490.00
	340.00

### OPTIONAL

Mass Value Certificate	Price
	\$560.00
	390.00
	270.00

### REPLACEMENT CASES

Part #	Price
<b>34697</b>	\$180.00
<b>34697</b>	180.00
<b>34697</b>	180.00

### M1

Set Size	Part #	Price
100g - 1 mg	<b>119561</b>	\$770.00
100g - 1g	<b>119560</b>	550.00

### OPTIONAL

Traceable Certificate	Price
	\$485.00
	205.00

### REPLACEMENT CASES

Part #	Price
<b>34697</b>	\$180.00
<b>34697</b>	180.00

### WEIGHT SET CONTENTS

100g - 1 mg	100g - 100 mg	100g - 1g
1 - 100g	1 - 100g	1 - 100g
1 - 50g	1 - 50g	1 - 50g
2 - 20g	2 - 20g	2 - 20g
1 - 10g	1 - 10g	1 - 10g
1 - 5g	1 - 5g	1 - 5g
2 - 2g	2 - 2g	2 - 2g
1 - 1g	1 - 1g	1 - 1g
1 - 500mg	1 - 500mg	
2 - 200mg	2 - 200mg	
1 - 100mg	1 - 100mg	
1 - 50mg		
2 - 20mg		
1 - 10mg		
1 - 5mg		
2 - 2mg		
1 - 1mg		
<b>Piece Count</b>		
21	13	9
<b>Total Weight</b>		
211.11g	211g	210g
Part #	Part #	Part #
<b>30838-Class E1</b>	<b>30842-Class E1</b>	<b>30846-Class E1</b>
<b>30839-Class E2</b>	<b>30843-Class E2</b>	<b>30847-Class E2</b>
<b>30840-Class F1</b>	<b>30844-Class F1</b>	<b>30848-Class F1</b>
<b>30841-Class F2</b>	<b>30845-Class F2</b>	<b>30849-Class F2</b>
<b>119561-Class M1</b>	-	<b>119560-Class M1</b>

### ADDITIONAL ACCESSORIES

Part #	Description	Price
<b>36092</b>	Statement of Accuracy*	\$45.00
<b>11714</b>	Weight gloves, white cotton	5.00
<b>11711</b>	Tweezer	3.00
<b>152414</b>	Premium tweezer	35.00
<b>25836</b>	Serial number	15.00
<b>50035</b>	Weight forceps, plastic, 200g - 500g	35.00
<b>11755</b>	Leaf weight cover	35.00



Set includes lifting device and gloves

# Metric Sets

Range: 200g

CLASS E1*			CLASS E2*			REPLACEMENT CASES	
Set Size	Part #	Price	Set Size	Part #	Price	Part #	Price
200g - 1 mg	<b>40546</b>	\$4,630.00	200g - 1 mg	<b>40550</b>	\$2,255.00	<b>34645</b>	\$270.00
200g - 100mg	<b>40547</b>	3,940.00	(2) 200g - 1 mg	<b>96468</b>	2,545.00	<b>34645</b>	270.00
200g - 1 g	<b>40548</b>	3,370.00	200g - 100mg	<b>40551</b>	1,775.00	<b>34645</b>	270.00
200g - 100g	<b>40549</b>	2,000.00	200g - 1 g	<b>40552</b>	1,395.00	<b>34645</b>	270.00
			(2) 200g - 1 g	<b>96469</b>	1,685.00	<b>34645</b>	270.00
			(2) 200g - 100g	<b>40553</b>	1,085.00	<b>34645</b>	270.00

*\*Calibration Report included, Statement of Accuracy not available Class E1 or E2*

CLASS F1			CLASS F2		OPTIONAL		OPTIONAL		REPLACEMENT CASES	
Set Size	Part #	Price	Part #	Price	Calibration Report	Mass Value Certificate	Part #	Price	Part #	Price
200g - 1 mg	<b>40554</b>	\$1,050.00	<b>40558</b>	\$995.00	\$880.00	\$630.00	<b>34645</b>	\$270.00	<b>34645</b>	\$270.00
(2) 200g - 1 mg	<b>96470</b>	1,190.00	<b>96472</b>	1,050.00	970.00	645.00	<b>34645</b>	270.00	<b>34645</b>	270.00
200g - 100mg	<b>40555</b>	1,110.00	<b>40559</b>	995.00	580.00	430.00	<b>34645</b>	270.00	<b>34645</b>	270.00
(2) 200g - 1 g	<b>96471</b>	815.00	<b>96473</b>	750.00	430.00	310.00	<b>34645</b>	270.00	<b>34645</b>	270.00
200g - 1 g	<b>40556</b>	795.00	<b>40560</b>	725.00	520.00	355.00	<b>34645</b>	270.00	<b>34645</b>	270.00
(2) 200g - 100g	<b>40557</b>	630.00	<b>40561</b>	600.00	290.00	150.00	<b>34645</b>	270.00	<b>34645</b>	270.00

# Metric Sets

Range: 200g

TEST WEIGHTS

## WEIGHT SET CONTENTS

200 g - 1 mg	(2) 200 g - 1 mg	200 g - 100 mg	200 g - 1 g	(2) 200 g - 1 g	(2) 200 g - 100 g
1 - 200g	2 - 200g	1 - 200g	1 - 200g	2 - 200g	2 - 200g
1 - 100g	1 - 100g	1 - 100g	1 - 100g	1 - 100g	1 - 100g
1 - 50g	1 - 50g	1 - 50g	1 - 50g	1 - 50g	
2 - 20g	2 - 20g	2 - 20g	2 - 20g	2 - 20g	
1 - 10g	1 - 10g	1 - 10g	1 - 10g	1 - 10g	
1 - 5g	1 - 5g	1 - 5g	1 - 5g	1 - 5g	
2 - 2g	2 - 2g	2 - 2g	2 - 2g	2 - 2g	
1 - 1g	1 - 1g	1 - 1g	1 - 1g	1 - 1g	
1 - 500mg	1 - 500mg	1 - 500mg			
2 - 200mg	2 - 200mg	2 - 200mg			
1 - 100mg	1 - 100mg	1 - 100mg			
1 - 50mg	1 - 50mg				
2 - 20mg	2 - 20mg				
1 - 10mg	1 - 10mg				
1 - 5mg	1 - 5mg				
2 - 2mg	2 - 2mg				
1 - 1mg	1 - 1mg				

### Piece Count

22	23	15	10	11	3
----	----	----	----	----	---

### Total Weight

411.11 g	611.11 g	611 g	410 g	610 g	500 g
Part #	Part #	Part #	Part #	Part #	Part #
<b>40546-Class E1</b>		<b>40547-Class E1</b>	<b>40548-Class E1</b>		<b>40549-Class E1</b>
<b>40550-Class E2</b>	<b>96468-Class E2</b>	<b>40551-Class E2</b>	<b>40552-Class E2</b>	<b>96469-Class E2</b>	<b>40553-Class E2</b>
<b>40554-Class F1</b>	<b>96470-Class F1</b>	<b>40555-Class F1</b>	<b>40556-Class F1</b>	<b>96471-Class F1</b>	<b>40557-Class F1</b>
<b>40558-Class F2</b>	<b>96472-Class F2</b>	<b>40559-Class F2</b>	<b>40560-Class F2</b>	<b>96473-Class F2</b>	<b>40561-Class F2</b>

## ADDITIONAL ACCESSORIES

Part #	Description	Price
<b>36092</b>	Statement of Accuracy*	\$45.00
<b>11714</b>	Weight gloves, white cotton	5.00
<b>11711</b>	Tweezer	3.00
<b>152414</b>	Premium tweezer	35.00
<b>25836</b>	Serial number	15.00
<b>50035</b>	Weight forceps, plastic, 200 g - 500 g	35.00
<b>11755</b>	Leaf weight cover	35.00

\*Not available for Class E1 or E2

## CASE INSERTS

Size	Part #	Price
200 g - 1 mg	<b>30607</b>	\$170.00
(2) 200 g - 1 mg	<b>84473</b>	325.00
(2) 200 g - 1 g	<b>84472</b>	325.00
(2) 200 g - 100 g	<b>30608</b>	325.00

www.ricelake.com | Phone: 800-472-6703

RICELAKE

# Metric Sets

Range: 500g

CLASS E1*			CLASS E2*			REPLACEMENT CASES	
Set Size	Part #	Price	Set Size	Part #	Price	Part #	Price
500 g - 1 mg	<b>30822</b>	\$5,560.00	500 g - 1 mg	<b>30823</b>	\$2,960.00	<b>34645</b>	\$270.00
500 g - 100 mg	<b>30826</b>	4,920.00	500 g - 100 mg	<b>30827</b>	2,555.00	<b>34645</b>	270.00
500 g - 1 g	<b>30830</b>	4,450.00	500 g - 1 g	<b>30831</b>	2,055.00	<b>34645</b>	270.00
500 g - 100 g	<b>30834</b>	2,745.00	500 g - 100 g	<b>30835</b>	1,500.00	<b>34645</b>	270.00

NOTE: Calibration Report is included with Class E1 and Class E2 kits, Statement of Accuracy not available

CLASS F1			CLASS F2		OPTIONAL	OPTIONAL	REPLACEMENT CASES	
Set Size	Part #	Price	Part #	Price	Calibration Report	Mass Value Certificate	Part #	Price
500 g - 1 mg	<b>30824</b>	\$1,760.00	<b>30825</b>	\$1,500.00	\$1,060.00	\$685.00	<b>34645</b>	\$270.00
500 g - 100 mg	<b>30828</b>	1,575.00	<b>30829</b>	1,385.00	760.00	515.00	<b>34645</b>	270.00
500 g - 1 g	<b>30832</b>	1,310.00	<b>30833</b>	1,160.00	610.00	395.00	<b>34645</b>	270.00
500 g - 100 g	<b>30836</b>	1,140.00	<b>30837</b>	850.00	310.00	155.00	<b>34645</b>	270.00



Set includes lifting device and gloves

# Metric Sets

Range: 500g

**WEIGHT SET CONTENTS**

500 g - 1 mg	500 g - 100 mg	500 g - 1 g	500 g - 100 g
1 - 500g	1 - 500g	1 - 500g	1 - 500g
2 - 200g	2 - 200g	2 - 200g	2 - 200g
1 - 100g	1 - 100g	1 - 100g	1 - 100g
1 - 50g	1 - 50g	1 - 50g	
2 - 20g	2 - 20g	2 - 20g	
1 - 10g	1 - 10g	1 - 10g	
1 - 5g	1 - 5g	1 - 5g	
2 - 2g	2 - 2g	2 - 2g	
1 - 1g	1 - 1g	1 - 1g	
1 - 500mg	1 - 500mg		
2 - 200mg	2 - 200mg		
1 - 100mg	1 - 100mg		
1 - 50mg			
2 - 20mg			
1 - 10mg			
1 - 5mg			
2 - 2mg			
1 - 1mg			

**Piece Count**

24	16	12	4
----	----	----	---

**Total Weight**

1.11111 kg	1.111 kg	1.11 kg	1 kg
Part #	Part #	Part #	Part #
30822-Class E1	30826-Class E1	30830-Class E1	30834-Class E1
30823-Class E2	30827-Class E2	30831-Class E2	30835-Class E2
30824-Class F1	30828-Class F1	30832-Class F1	30836-Class F1
30825-Class F2	30829-Class F2	30833-Class F2	30837-Class F2

**ADDITIONAL ACCESSORIES**

Part #	Description	Price
36092	Statement of Accuracy*	\$45.00
11714	Weight gloves, white cotton	5.00
11711	Tweezer	3.00
152414	Premium tweezer	35.00
25836	Serial number	15.00
50035	Weight forceps, plastic, 200 g - 500 g	35.00
11755	Leaf weight cover	35.00
50000	Tong assembly 1 kg - 200 g	60.00

\*Not available for Class E1 or E2

**CASE INSERTS**

Size	Part #	Price
500 g - 1 mg	30607	\$170.00
500 g - 100 g	30608	270.00



# Metric Sets

Range: 1 kg

CLASS E1*			CLASS E2*			REPLACEMENT CASES	
Set Size	Part #	Price	Set Size	Part #	Price	Part #	Price
1 kg - 1 mg	<b>30806</b>	\$6,355.00	1 kg - 1 mg	<b>30807</b>	\$3,465.00	<b>30605</b>	\$1,595.00
1 kg - 100 mg	<b>30810</b>	5,370.00	1 kg - 100 mg	<b>30811</b>	3,165.00	<b>30605</b>	1,595.00
1 kg - 1 g	<b>30814</b>	4,840.00	1 kg - 1 g	<b>30815</b>	3,005.00	<b>30605</b>	1,595.00
1 kg - 100 g	<b>30818</b>	3,280.00	1 kg - 100 g	<b>30819</b>	2,400.00	<b>30606</b>	1,435.00

\*Calibration Report included, Statement of Accuracy not available Class E1 or E2

CLASS F1			CLASS F2		OPTIONAL	OPTIONAL	REPLACEMENT CASES	
Set Size	Part #	Price	Part #	Price	Calibration Report	Mass Value Certificate	Part #	Price
1 kg - 1 mg	<b>30808</b>	\$2,390.00	<b>30809</b>	\$2,155.00	\$1,150.00	\$725.00	<b>30605</b>	\$1,595.00
1 kg - 100 mg	<b>30812</b>	2,335.00	<b>30813</b>	2,130.00	850.00	505.00	<b>30605</b>	1,595.00
1 kg - 1 g	<b>30816</b>	2,315.00	<b>30817</b>	2,200.00	700.00	435.00	<b>30605</b>	1,595.00
1 kg - 100 g	<b>30820</b>	2,030.00	<b>30821</b>	1,775.00	400.00	195.00	<b>30606</b>	1,435.00



Set includes lifting device and gloves

# Metric Sets

Range: 1 kg

**WEIGHT SET CONTENTS**

1 kg - 1 mg	1 kg - 100 mg	1 kg - 1 g	1 kg - 100 g
1 - 1 kg	1 - 1 kg	1 - 1 kg	1 - 1 kg
1 - 500 g	1 - 500 g	1 - 500 g	1 - 500 g
2 - 200 g	2 - 200 g	2 - 200 g	2 - 200 g
1 - 100 g	1 - 100 g	1 - 100 g	1 - 100 g
1 - 50 g	1 - 50 g	1 - 50 g	
2 - 20 g	2 - 20 g	2 - 20 g	
1 - 10 g	1 - 10 g	1 - 10 g	
1 - 5 g	1 - 5 g	1 - 5 g	
2 - 2 g	2 - 2 g	2 - 2 g	
1 - 1 g	1 - 1 g	1 - 1 g	
1 - 500 mg	1 - 500 mg		
2 - 200 mg	2 - 200 mg		
1 - 100 mg	1 - 100 mg		
1 - 50 mg			
2 - 20 mg			
1 - 10 mg			
1 - 5 mg			
2 - 2 mg			
1 - 1 mg			

**Piece Count**

25	17	13	5
----	----	----	---

**Total Weight**

2.11111 kg	2.111 kg	2.11 kg	2 kg
Part #	Part #	Part #	Part #
30806-Class E1	30810-Class E1	30814-Class E1	30818-Class E1
30807-Class E2	30811-Class E2	30815-Class E2	30819-Class E2
30808-Class F1	30812-Class F1	30816-Class F1	30820-Class F1
30809-Class F2	30813-Class F2	30817-Class F2	30821-Class F2

**ADDITIONAL ACCESSORIES**

Part #	Description	Price
36092	Statement of Accuracy	\$45.00
11714	Weight gloves, white cotton	5.00
11711	Tweezer	3.00
152414	Premium tweezer	35.00
25836	Serial number	15.00
50035	Weight forceps, plastic, 200 g - 500 g	35.00
11755	Leaf weight cover	35.00
50000	Tong assembly 1 kg - 200 g	60.00

**SECONDARY CASE**

Size	Part #	Price
100 g - 1 mg	34697	\$180.00

# Metric Sets

Range: 2 kg

CLASS E1*			CLASS E2*			REPLACEMENT CASES	
Set Size	Part #	Price	Set Size	Part #	Price	Part #	Price
2 kg - 1 mg	<b>40518</b>	\$8,380.00	2 kg - 1 mg	<b>40523</b>	\$4,325.00	<b>84474</b>	\$1,595.00
2 kg - 100 mg	<b>40519</b>	7,140.00	(2) 2 kg - 1 mg	<b>96455</b>	4,760.00	<b>96308</b>	1,595.00
2 kg - 1 g	<b>40520</b>	6,105.00	2 kg - 1 g	<b>40525</b>	3,415.00	<b>84474</b>	1,595.00
2 kg - 100 g	<b>40521</b>	4,475.00	(2) 2 kg - 1 g	<b>96457</b>	4,300.00	<b>96308</b>	1,595.00

\*Calibration Report included Statement of Accuracy not available Class E1 or E2

CLASS F1			CLASS F2		OPTIONAL	OPTIONAL	REPLACEMENT CASES	
Set Size	Part #	Price	Part #	Price	Calibration Report	Mass Value Certificate	Part #	Price
2 kg - 1 mg	<b>40528</b>	\$3,400.00	<b>40533</b>	\$2,950.00	\$1,250.00	\$850.00	<b>96308</b>	\$1,595.00
(2) 2 kg - 1 mg	<b>96459</b>	3,555.00	<b>96463</b>	2,800.00	1,360.00	910.00	<b>84474</b>	1,595.00
2 kg - 1 g	<b>40530</b>	2,630.00	<b>40535</b>	2,450.00	800.00	490.00	<b>96308</b>	1,595.00
(2) 2 kg - 1 g	<b>96461</b>	3,110.00	<b>96465</b>	2,680.00	1,100.00	550.00	<b>84474</b>	1,595.00



Set includes lifting device and gloves

# Metric Sets

Range: 2 kg

**WEIGHT SET CONTENTS**

2 kg - 1 mg	2 kg - 100 mg	(2) 2 kg -1 mg	2 kg - 1 g	(2) 2 kg -1 g	2 kg - 100 g
1 - 2 kg	1	2 - 2 kg	1 - 2 kg	2 - 2 kg	1
1 - 1 kg	1	1 - 1 kg	1 - 1 kg	1 - 1 kg	1
1 - 500 g	1	1 - 500 g	1 - 500 g	1 - 500 g	1
2 - 200 g	2	2 - 200 g	2 - 200 g	2 - 200 g	2
1 - 100 g	1	1 - 100 g	1 - 100 g	1 - 100 g	1
1 - 50 g	1	1 - 50 g	1 - 50 g	1 - 50 g	
2 - 20 g	2	2 - 20 g	2 - 20 g	2 - 20 g	
1 - 10 g	1	1 - 10 g	1 - 10 g	1 - 10 g	
1 - 5 g	1	1 - 5 g	1 - 5 g	1 - 5 g	
2 - 2 g	2	2 - 2 g	2 - 2 g	2 - 2 g	
1 - 1 g	1	1 - 1 g	1 - 1 g	1 - 1 g	
1 - 500 mg	1	1 - 500 mg			
2 - 200 mg	2	2 - 200 mg			
1 - 100 mg	1	1 - 100 mg			
1 - 50 mg		1 - 50 mg			
2 - 20 mg		2 - 20 mg			
1 - 10 mg		1 - 10 mg			
1 - 5 mg		1 - 5 mg			
2 - 2 mg		2 - 2 mg			
1 - 1 mg		1 - 1 mg			

**Piece Count**

26	18	27	14	15	6
----	----	----	----	----	---

**Total Weight**

4.11111 kg		6.11111 kg	4.11 kg	6.11 kg	
Part #	Part #	Part #	Part #	Part #	Part #
40518-Class E1	40519-Class E1	96455-Class E2	40520-Class E1	96457-Class E2	40521- Class E1
40523-Class E2		96459-Class F1	40525-Class E2	96461-Class F1	
40528-Class F1		96463-Class F2	40530-Class F1	96465-Class F2	
40533-Class F2			40535-Class F2		

**ADDITIONAL ACCESSORIES**

Part #	Description	Price
36092	Statement of Accuracy*	\$45.00
11714	Weight gloves, white cotton	5.00
11711	Tweezer	3.00
152414	Premium tweezer	35.00
25836	Serial number	15.00
50035	Weight forceps, plastic, 200 g - 500 g	35.00
11755	Leaf weight cover	35.00
50000	Tong assembly 1 kg - 200 g	60.00
50037	Lifter, 5 kg and 2 kg	45.00

**SECONDARY CASE**

Size	Part #	Price
100 g - 1 mg	34697	\$180.00

# Metric Sets

Range: 5 kg

CLASS E1*			CLASS E2*			REPLACEMENT CASES	
Set Size	Part #	Price	Set Size	Part #	Price	Part #	Price
5 kg - 1 mg	<b>30785</b>	\$9,885.00	5 kg - 1 mg	<b>30786</b>	\$5,630.00	<b>30602</b>	\$1,565.00
5 kg - 100 mg	<b>30789</b>	9,505.00	5 kg - 100 mg	<b>30790</b>	5,410.00	<b>30602</b>	1,565.00
5 kg - 1 g	<b>30793</b>	9,125.00	5 kg - 1 g	<b>30794</b>	4,875.00	<b>30602</b>	1,565.00
5 kg - 100 g	<b>30797</b>	6,440.00	5 kg - 100 g	<b>30798</b>	4,270.00	<b>30603</b>	1,565.00
5 kg - 1 kg	<b>30802</b>	5,445.00	5 kg - 1 kg	<b>30803</b>	3,630.00	<b>30604</b>	1,435.00

\*Calibration Report included, Statement of Accuracy not available Class E1 or E2

CLASS F1			CLASS F2		OPTIONAL	OPTIONAL	REPLACEMENT CASES	
Set Size	Part #	Price	Part #	Price	Calibration Report	Mass Value Certificate	Part #	Price
5 kg - 1 mg	<b>30787</b>	\$4,210.00	<b>30788</b>	\$3,850.00	\$1,330.00	\$800.00	<b>30602</b>	\$1,565.00
5 kg - 100 mg	<b>30791</b>	4,285.00	<b>30792</b>	3,740.00	1,165.00	725.00	<b>30602</b>	1,565.00
5 kg - 1 g	<b>30795</b>	3,965.00	<b>30796</b>	3,400.00	1,015.00	605.00	<b>30602</b>	1,565.00
5 kg - 100 g	<b>30800</b>	3,635.00	<b>30801</b>	3,120.00	715.00	365.00	<b>30603</b>	1,565.00
5 kg - 1 kg	<b>30804</b>	3,420.00	<b>30805</b>	2,875.00	370.00	210.00	<b>30604</b>	1,435.00

CLASS M1			OPTIONAL	REPLACEMENT CASES	
Set Size	Part #	Price	Traceable Certificate	Part #	Price
5 kg - 1 mg	<b>126169</b>	\$2,220.00	\$740.00	<b>126164</b>	\$200.00
5 kg - 1 g	<b>126168</b>	1,920.00	470.00	<b>126164</b>	200.00



Set includes lifting device and gloves

# Metric Sets

Range: 5 kg

TEST WEIGHTS

## WEIGHT SET CONTENTS

5 kg - 1 mg	5 kg - 100 mg	5 kg - 1 g	5 kg - 100 g	5 kg - 1 kg
1 - 5 kg	1 - 5 kg	1 - 5 kg	1 - 5 kg	1 - 5 kg
2 - 2 kg	2 - 2 kg	2 - 2 kg	2 - 2 kg	2 - 2 kg
1 - 1 kg	1 - 1 kg	1 - 1 kg	1 - 1 kg	1 - 1 kg
1 - 500 g	1 - 500 g	1 - 500 g	1 - 500 g	
2 - 200 g	2 - 200 g	2 - 200 g	2 - 200 g	
1 - 100 g	1 - 100 g	1 - 100 g	1 - 100 g	
1 - 50 g	1 - 50 g	1 - 50 g		
2 - 20 g	2 - 20 g	2 - 20 g		
1 - 10 g	1 - 10 g	1 - 10 g		
1 - 5 g	1 - 5 g	1 - 5 g		
2 - 2 g	2 - 2 g	2 - 2 g		
1 - 1 g	1 - 1 g	1 - 1 g		
1 - 500 mg	1 - 500 mg			
2 - 200 mg	2 - 200 mg			
1 - 100 mg	1 - 100 mg			
1 - 50 mg				
2 - 20 mg				
1 - 10 mg				
1 - 5 mg				
2 - 2 mg				
1 - 1 mg				

### Piece Count

27	19	15	8	4
----	----	----	---	---

### Total Weight

11.11111 kg	11.111 kg	11.11 kg	11 kg	10 kg
Part #	Part #	Part #	Part #	Part #
<b>30785-Class E1</b>	<b>30789-Class E1</b>	<b>30793-Class E1</b>	<b>30797-Class E1</b>	<b>30802-Class E1</b>
<b>30786-Class E2</b>	<b>30790-Class E2</b>	<b>30794-Class E2</b>	<b>30798-Class E2</b>	<b>30803-Class E2</b>
<b>30787-Class F1</b>	<b>30791-Class F1</b>	<b>30795-Class F1</b>	<b>30800-Class F1</b>	<b>30804-Class F1</b>
<b>30788-Class F2</b>	<b>30792-Class F2</b>	<b>30796-Class F2</b>	<b>30801-Class F2</b>	<b>30805-Class F2</b>
<b>126169-Class M1</b>		<b>126168-Class M1</b>		

## ADDITIONAL ACCESSORIES

Part #	Description	Price
<b>36092</b>	Statement of Accuracy*	\$45.00
<b>11714</b>	Weight gloves, white cotton	5.00
<b>11711</b>	Tweezer	3.00
<b>152414</b>	Premium tweezer	35.00
<b>25836</b>	Serial number	15.00
<b>50035</b>	Weight forceps, plastic, 200 g - 500 g	35.00
<b>11755</b>	Leaf weight cover	35.00
<b>50000</b>	Tong assembly 1 kg - 200 g	60.00
<b>50037</b>	Lifter, 5 kg and 2 kg	45.00

## SECONDARY CASE

Size	Part #	Price
100 g - 1 mg	<b>34697</b>	\$180.00

www.ricelake.com | Phone: 800-472-6703

RICE LAKE

# Metric Sets

Range: 10kg

CLASS E2*			REPLACEMENT CASES	
Set Size	Part #	Price	Part #	Price
10 kg - 1 mg	<b>65213</b>	\$8,000.00	<b>65218</b>	\$1,995.00
10 kg - 100 mg	<b>96419</b>	7,740.00	<b>65218</b>	1,995.00
10 kg - 1 g	<b>96415</b>	7,515.00	<b>65218</b>	1,995.00
10 kg - 100 g	<b>96420</b>	6,575.00	<b>65218</b>	1,995.00
10 kg - 1 kg	<b>96421</b>	5,870.00	<b>65218</b>	1,995.00

\*Calibration Report included, Statement of Accuracy not available Class E2

CLASS F1			CLASS F2		OPTIONAL	OPTIONAL	REPLACEMENT CASES	
Set Size	Part #	Price	Part #	Price	Calibration Report	Mass Value Certificate	Part #	Price
10 kg - 1 mg	<b>65214</b>	\$6,625.00	<b>65215</b>	\$5,890.00	\$1,420.00	\$850.00	<b>65218</b>	\$1,995.00
10 kg - 100 mg	<b>96429</b>	6,510.00	<b>96445</b>	5,790.00	1,265.00	780.00	<b>65218</b>	1,995.00
10 kg - 1 g	<b>96430</b>	6,405.00	<b>96446</b>	5,705.00	1,120.00	660.00	<b>65218</b>	1,995.00
10 kg - 100 g	<b>96467</b>	6,005.00	<b>96444</b>	5,350.00	820.00	420.00	<b>65218</b>	1,995.00
10 kg - 1 kg	<b>96432</b>	5,370.00	<b>96448</b>	4,785.00	510.00	270.00	<b>65218</b>	1,995.00

### ADDITIONAL ACCESSORIES

Part #	Description	Price
<b>11714</b>	Weight gloves, white cotton	5.00
<b>152414</b>	Premium tweezers	35.00



Set includes lifting device and gloves

# Metric Sets

Range: 10kg

**WEIGHT SET CONTENTS**

10 kg - 1 mg	10 kg - 100 mg	10 kg - 1 g	10 kg - 100 g	10 kg - 1 kg
1 - 10 kg	1 - 10 kg	1 - 10 kg	1 - 10 kg	1 - 10 kg
1 - 5 kg	1 - 5 kg	1 - 5 kg	1 - 5 kg	1 - 5 kg
2 - 2 kg	2 - 2 kg	2 - 2 kg	2 - 2 kg	2 - 2 kg
1 - 1 kg	1 - 1 kg	1 - 1 kg	1 - 1 kg	1 - 1 kg
1 - 500 g	1 - 500 g	1 - 500 g	1 - 500 g	
2 - 200 g	2 - 200 g	2 - 200 g	2 - 200 g	
1 - 100 g	1 - 100 g	1 - 100 g	1 - 100 g	
1 - 50 g	1 - 50 g	1 - 50 g		
2 - 20 g	2 - 20 g	2 - 20 g		
1 - 10 g	1 - 10 g	1 - 10 g		
1 - 5 g	1 - 5 g	1 - 5 g		
2 - 2 g	2 - 2 g	2 - 2 g		
1 - 1 g	1 - 1 g	1 - 1 g		
1 - 500 mg	1 - 500 mg			
2 - 200 mg	2 - 200 mg			
1 - 100 mg	1 - 100 mg			
1 - 50 mg				
2 - 20 mg				
1 - 10 mg				
1 - 5 mg				
2 - 2 mg				
1 - 1 mg				

**Piece Count**

28	20	16	9	5
----	----	----	---	---

**Total Weight**

21.11111 kg	21.11105 kg	21.111 kg	21 kg	20 kg
Part #	Part #	Part #	Part #	Part #
<b>65213-Class E2</b>	<b>96419-Class E2</b>	<b>96415-Class E2</b>	<b>96420-Class E2</b>	<b>96421-Class E2</b>
<b>65214-Class F1</b>	<b>96429-Class F1</b>	<b>96430-Class F1</b>	<b>96467-Class F1</b>	<b>96432-Class F1</b>
<b>65215-Class F2</b>	<b>96445-Class F2</b>	<b>96446-Class F2</b>	<b>96444-Class F2</b>	<b>96448-Class F2</b>

**ADDITIONAL ACCESSORIES**

Part #	Description	Price
<b>36092</b>	Statement of Accuracy*	\$45.00
<b>11714</b>	Weight gloves, white cotton	5.00
<b>11711</b>	Tweezer	3.00
<b>152414</b>	Premium tweezer	35.00
<b>25836</b>	Serial number	15.00
<b>50035</b>	Weight forceps, plastic, 200 g - 500 g	35.00
<b>11755</b>	Leaf weight cover	35.00
<b>50000</b>	Tong assembly 1 kg - 200 g	60.00
<b>50037</b>	Lifter, 5 kg and 2 kg	45.00

\*Not available for Class E2

**SECONDARY CASE**

Size	Part #	Price
100 g - 1 mg	<b>34697</b>	\$180.00



# Metric

Range: 20kg

CLASS E2*			REPLACEMENT CASES	
Set Size	Part #	Price	Part #	Price
20 kg - 1 mg	<b>65210</b>	\$10,200.00	<b>65219</b>	\$1,890.00
20 kg - 100 mg	<b>96416</b>	9,815.00	<b>65219</b>	1,890.00
20 kg - 1 g	<b>96414</b>	9,615.00	<b>65219</b>	1,890.00
20 kg - 100 g	<b>96417</b>	8,920.00	<b>65219</b>	1,890.00
20 kg - 1 kg	<b>96418</b>	7,980.00	<b>65219</b>	1,890.00

\*Calibration Report included, Statement of Accuracy not available Class E2

CLASS F1			CLASS F2		OPTIONAL		OPTIONAL		REPLACEMENT CASES	
Set Size	Part #	Price	Part #	Price	Calibration Report	Mass Value Certificate	Part #	Price	Part #	Price
20 kg - 1 mg	<b>65211</b>	\$8,660.00	<b>65212</b>	\$7,700.00	\$1,600.00	\$975.00	<b>65219</b>	\$1,890.00	<b>65219</b>	\$1,890.00
20 kg - 100 mg	<b>96428</b>	8,505.00	<b>96447</b>	7,575.00	1,375.00	835.00	<b>65219</b>	1,890.00	<b>65219</b>	1,890.00
20 kg - 1 g	<b>96425</b>	8,410.00	<b>96441</b>	7,490.00	1,225.00	720.00	<b>65219</b>	1,890.00	<b>65219</b>	1,890.00
20 kg - 100 g	<b>96426</b>	8,010.00	<b>96442</b>	7,135.00	925.00	480.00	<b>65219</b>	1,890.00	<b>65219</b>	1,890.00
20 kg - 1 kg	<b>96427</b>	7,380.00	<b>96443</b>	6,570.00	615.00	325.00	<b>65219</b>	1,890.00	<b>65219</b>	1,890.00

# Metric

Range: 20 kg

### WEIGHT SET CONTENTS

20 kg - 1 mg	20 kg - 100 mg	20 kg - 1 g	20 kg - 100 g	20 kg - 1 kg
1 - 20 kg	1 - 20 kg	1 - 20 kg	1 - 20 kg	1 - 20 kg
1 - 10 kg	1 - 10 kg	1 - 10 kg	1 - 10 kg	1 - 10 kg
1 - 5 kg	1 - 5 kg	1 - 5 kg	1 - 5 kg	1 - 5 kg
2 - 2 kg	2 - 2 kg	2 - 2 kg	2 - 2 kg	2 - 2 kg
1 - 1 kg	1 - 1 kg	1 - 1 kg	1 - 1 kg	1 - 1 kg
1 - 500 g	1 - 500 g	1 - 500 g	1 - 500 g	
2 - 200 g	2 - 200 g	2 - 200 g	2 - 200 g	
1 - 100 g	1 - 100 g	1 - 100 g	1 - 100 g	
1 - 50 g	1 - 50 g	1 - 50 g		
2 - 20 g	2 - 20 g	2 - 20 g		
1 - 10 g	1 - 10 g	1 - 10 g		
1 - 5 g	1 - 5 g	1 - 5 g		
2 - 2 g	2 - 2 g	2 - 2 g		
1 - 1 g	1 - 1 g	1 - 1 g		
1 - 500 mg	1 - 500 mg			
2 - 200 mg	2 - 200 mg			
1 - 100 mg	1 - 100 mg			
1 - 50 mg				
2 - 20 mg				
1 - 10 mg				
1 - 5 mg				
2 - 2 mg				
1 - 1 mg				

#### Piece Count

29	21	17	10	6
----	----	----	----	---

#### Total Weight

41.11111 kg	41.11105 kg	41.111 kg	41 kg	40 kg
Part #	Part #	Part #	Part #	Part #
<b>65210-Class E2</b>	<b>96416-Class E2</b>	<b>96414-Class E2</b>	<b>96417-Class E2</b>	<b>96418-Class E2</b>
<b>65211-Class F1</b>	<b>96428-Class F1</b>	<b>96425-Class F1</b>	<b>96426-Class F1</b>	<b>96427-Class F1</b>
<b>65212-Class F2</b>	<b>96447-Class F2</b>	<b>96441-Class F2</b>	<b>96442-Class F2</b>	<b>96443-Class F2</b>

### ADDITIONAL ACCESSORIES

Part #	Description	Price
<b>36092</b>	Statement of Accuracy	\$45.00
<b>11714</b>	Weight gloves, white cotton	5.00
<b>11711</b>	Tweezer	3.00
<b>152414</b>	Premium tweezer	35.00
<b>25836</b>	Serial number	15.00
<b>50035</b>	Weight forceps, plastic, 200 - 500 g	35.00
<b>11755</b>	Leaf weight cover	35.00
<b>50000</b>	Tong assembly 1 kg - 200 g	60.00
<b>50037</b>	Lifter, 5 and 2 kg	45.00

### SECONDARY CASE

Size	Part #	Price
100g - 1 mg	<b>34697</b>	\$180.00

Accessories  
**Sealing Plugs**



**SEALING PLUGS**

Part #	Diameter	Price
<b>Lead Plugs</b>		
11749	2 3/4 in (69.8 mm)	\$3.50
11750	1 7/8 in (47.6 mm)	2.75
11751	1 in (25.4 mm)	2.50
11752	1/2 in (12.7 mm)	2.50
11753	1 1/4 in (31.7 mm)	2.50
11760	9/16 in (14.3 mm)	2.50
11761	5/8 in (15.9 mm)	2.50
11765	3/4 in (19.1 mm)	2.50
11785	7/8 in (22.2 mm)	2.50
<b>Aluminum Plugs</b>		
11744	3/8 in (9.5 mm)	1.20
11745	1/2 in (12.7 mm)	1.20
11746	5/8 in (15.9 mm)	1.20
11762	1 in (25.4 mm)	1.20
11767	9/16 in (14.3 mm)	2.50
11775	7/8 in (22.2 mm)	2.00
11776	3/4 in (19.1 mm)	1.20
<b>Back-up Plugs</b>		
11748	2 3/4 in (69.8 mm)	3.95
11766	3/4 in (19.1 mm)	3.35
11710	1 in (25.4 mm)	1.40
11699	1 7/8 in (47.6 mm)	1.40
<b>Back-up Plugs Stainless Steel</b>		
44992	1 in (25.4 mm)	1.20
44993	5/8 in (15.9 mm)	3.00
44994	3/8 in (9.5 mm)	3.50
<b>Stainless Steel Plugs</b>		
11709	15/16 in (23.0 mm)	2.50

TEST WEIGHTS

www.ricelake.com | Phone: 800-472-6703

**RICE LAKE**

# Gloves/Transfer Equipment



Gloves

### Cotton 11714

- Essential tool for proper weight-handling
- Proper protection for preventing hand residue
- Residue can throw off a weight's calibration and certification for accuracy
- Rice Lake recommends using cotton gloves to handle all precision weights

### Plastic 11773

Plastic gloves are an acceptable handling tool to keep dirt and residue off your weights. Better than handling precision weights barehanded, plastic gloves are economical, disposable, convenient, and help maintain the integrity of your weights.

### GLOVES

Part #	Description	Price
11714	White Cloth (pair)	\$5.00
11773	Vinyl glove	1.50

### TRANSFER EQUIPMENT

Part #	Description	Price
11711	Forceps, 3 5/8 in 100 g - 1 mg	\$3.00
50035	Forceps, 4 3/4 in	35.00
11747	Plastic bar 200 g - 4 kg	15.00
11712	Metal handle 5 kg +	60.00
65640*	Metal forceps	15.00
50037	Weight lifter, OIML 2 kg and 5 kg	45.00
50000	Tong assembly, 24 cm x 7.5 cm	60.00
152414	Tweezers, premium, 140 mm	35.00
157109	Tweezers, premium, 220 mm	40.00

\* Not recommended for use with polished weights.



## Guidelines for Selecting a Case

- Find the diameter, height and total mass of the weights that will need a case
- Review case dimensions to determine best fit
- Note weight limits of the case and choose accordingly

### Things to keep in mind:

- Foam needs 0.5 inches between weights and edge of case
- Always select the smallest case best fitting your need
- Weights should always be stored and transported in the upright position
- The shoulder edge of the weight should be level with the foam insert
- Some cases are recommended for storage only and should not be used for shipping

## Medium-Duty Cases

Medium-duty Cases are primarily used for manually transporting test weights as they effectively absorb shock and resist changes in environment.

### ABS Plastic 11531, 11534 and 11572

- ABS plastic is considered superior for its strength, gloss, and electrical insulation properties—an excellent choice for encasing weights
- All metal hardware establishes the security of your weights
- Top-mounted handle makes transporting the weights effortless
- Custom-cut foam inserts are used for insulating between the weights
- Three sizes available

### Wooden Cases 34645

- Walnut-constructed and felt-lined
- Built-to-order and designed specifically for our weight sets
- Available in 5 - 20 kg capacities
- Secured by hinged latches
- Case keeps weights free of dust and contaminants
- Protects your weights in storage and during transportation
- Cases should be packed in an external box during shipping to protect them

### PVC Cases 11596

- Available in capacities from 100 g - 1 mg for Precision Laboratory SST weight sets
- Also available for ASTM Class 0 weights in 100 g - 1 mg capacities

## Industrial-Quality Cases

These heavy-duty cases are designed to be used in place of large wooden cases when portability is desired. The recessed latches provide protection insurance for your weights.

### Black Thermoformed Cases 156989, 156285 and 156284

- Excellent for transporting weights
- Recessed, heavy-duty latches confidently secure contents
- Ergonomic handles retain preferred treatment of weights
- Metal hardware resists natural wear and tear
- Special case cuttings are required for heavy duty cases at an additional charge

### Black Injection-Molded Watertight Case 158121

- Designed for custom weight sets
- Ergonomic top-mounted handle provides ideal weight positioning
- Interior is custom-molded to the weights to be stored

## Light-Duty/Single Weight Cases

Light-duty/Single Weight Cases can be used for storage and shipping smaller capacity weights within additional materials.

### Plastic 153860 and 87982

- Light-duty plastic cases are used for shipping lighter capacity weights—typically single weights not exceeding 5 lb
- Plastic hinges, latches, and side mounted handle keep this case extremely lightweight and portable
- Uncut foam is included while custom-cut is available for an extra charge
- Custom-cut foam insert protects each weight from impact during transport

### Leatherette 69229, 69228 and 69429

- Secure storage of single weights with snap lid
- Considered light duty and used for storage and shipping
- Leatherette in a non-porous material—ideal weight protection
- Three sizes of leatherette cases available

### Acrylic: Clean Room 89179 and 89180

- Ideal for all clean room environments
- Tough, clear acrylic protects your valuable investment
- Provide compliance for stringent clean room requirements
- Not recommended for shipping, developed exclusively for storage
- Available as an accessory only
- Rice Lake recommends shipping weights using wooden or plastic weight cases

Accessories  
Cases

TEST WEIGHTS



Shown with optional insert



87982

11534



158121



156989



156285



156284



21230



11531



11572



69429



69229



69228

PELICAN CASES

Part #	Width	Length	Closed Height	Price
21230	22 in	17 in	8 in	\$345.00
21229	17 in	11 3/4 in	6 in	230.00

REPLACEMENT CASES

Part #	Width **	Length **	Closed Height **	Price
<b>Acrylic Clean Room Cases</b>				
89180	4.7 in	8.7 in	2.8 in	\$185.00
89179			1.8 in	100.00
89181	5 1/4 in	12 in	4 in	295.00
89182	8 1/2 in	13 1/4 in	5 3/4 in	465.00
<b>Leatherette</b>				
69429	3 3/4 in	1 7/8 in	1 1/16 in	30.00
69229	3 7/16 in	2 1/2 in	7/8 in	30.00
69228	4 in	4 in	4 1/2 in	42.00
<b>Plastic</b>				
87982	9 1/2 in	6 in	3 1/2 in	65.00
<b>ABS Plastic</b>				
11531	13 1/2 in	7 5/8 in	6 in	200.00
11534	14 3/8 in	9 3/8 in	7 5/8 in	210.00
11572	8 3/8 in	6 1/2 in	7 1/8 in	150.00
<b>Sealers Cube Wt - with precut foam insert*</b>				
40783	14 3/8 in	9 3/8 in	7 5/8 in	290.00
<b>Heavy Duty Industrial Cases</b>				
156989	16.3 in	22.4 in	10.5 in	690.00
156285	11.4 in	16.4 in	9.0 in	462.00
158121	9.5 in	12.63 in	4.75 in	265.00
156284	9.9 in	9.9 in	11.0 in	372.00
<b>Protection Containers</b>				
80420	Capsule			3.00
50038	Vial			3.00

\* Metric or Avoirdupois, no storage pocket

\*\* Inside case dimensions

www.ricelake.com | Phone: 800-472-6703

RICELAKE

# Transfer Cart/Touch-Up Paint/Canvas Dust Covers



11702

Transfer Cart

11700



Touch-up/Repair Paint



Canvas Dust Covers

## TRANSFER CART

Part #	Width	Handle Width	Height	Price
<b>11700</b>	36 1/2 in (927.1 mm)	74 1/2 in (1892.3 mm)	29 in (736.6 mm)	\$1,395.00

For use on smooth, level surfaces— especially for moving 500 or 1000 lb heavy-capacity weights.

<b>11702</b>	24 in (609 mm)	35 in (889 mm)	14 in (355 mm)	1,600.00
--------------	-------------------	-------------------	-------------------	----------

For use on smooth, level surfaces—for holding up to fifteen 50 lb grip-handle weights.

## TOUCH-UP/REPAIR PAINT

Part #	Color	Price
<b>88561</b>	Aerosol spray (gold)	\$25.00
<b>88562</b>	Aerosol spray (silver)	25.00
<b>88563</b>	Aerosol spray (primer)	25.00

Spray paint ships UPS Ground ONLY

## CANVAS DUST COVERS

Capacity	Weight Part #	Cover Part #	Price
200 lb	<b>(12890)</b>	<b>11720</b>	\$175.00
500 lb	<b>(12844)</b>	<b>11722</b>	175.00
750 lb	<b>(12880)</b>	<b>11723</b>	175.00
1000 lb	<b>(12850)</b>	<b>11724</b>	175.00
1250 lb	<b>(12858)</b>	<b>11727</b>	175.00
2000 lb	<b>(12866)</b>	<b>11729</b>	175.00
5000 lb	<b>(12888)</b>	<b>11735</b>	175.00
100 kg	<b>(12817)</b>	<b>11738</b>	175.00
250 kg	<b>(12782)</b>	<b>11740</b>	175.00
500 kg	<b>(12797)</b>	<b>11741</b>	175.00
1000 kg	<b>(12801)</b>	<b>11742</b>	175.00
2000 kg	<b>(12821)</b>	<b>11743</b>	175.00

## Discontinued Products

Availability limited to existing stock, contact Sales for pricing; additional specifications available upon request.

## PART NUMBER

Part #	Description	Class
10425	Weight, Counterpoise round slotted interlocking, 5 lb x 5/8 lb 2-15/16 Dia	ASTM Class 7 Cast Iron
12729	4 GN Weight, Leaf	NIST Class F stainless steel satin density 7.95
12731	6 GN Weight, Leaf	NIST Class F stainless steel satin density 7.95
12737	30 GN Weight, Cylindrical	NIST Class F stainless steel satin density 7.84
12738	50 GN Weight, Cylindrical	NIST Class F stainless steel satin density 7.84
12742	300 GN Weight, Cylindrical	NIST Class F stainless steel satin density 7.84
12745	1,000 GN Weight, Cylindrical	NIST Class F stainless steel satin density 7.84
11154	1 oz Weight, Slotted	ASTM Class 4 stainless steel satin



# Truck/Rail/Livestock Scales

Table of Contents

<b>SURVIVOR® Truck, Rail and Livestock Scales</b> .....	<b>916</b>
<b>RailBoss™</b> .....	<b>917</b>
Full Draft and Double Draft	
<b>RoughDeck® AX</b> .....	<b>919</b>
Axle Scale	
<b>AX3040</b> .....	<b>920</b>
Axle Scale	

**ESPAÑOL** | Visit [ricelake.com/spanish](http://ricelake.com/spanish)  
to see all RLWS materials  
available in Spanish

The following product names, logos, brands, and other trademarks featured or referred to within this publication are the property of their respective trademark holders.

# SURVIVOR® Truck, Rail and Livestock Scales

For more information on Rice Lake's full line of SURVIVOR® truck, rail and livestock scales, please visit our website at [www.ricelake.com](http://www.ricelake.com) or call 800-472-6703 and ask to speak with a heavy capacity team member.



## Truck Scales:

[www.ricelake.com/truckscales](http://www.ricelake.com/truckscales)

SURVIVOR® OTR

Heavy-duty, top access, low profile concrete or steel deck scales

SURVIVOR® OTR-SV

Standard-duty, top access, low profile steel deck scales

SURVIVOR® OTR-XV

Extreme vehicle, top access, concrete or steel deck scales

SURVIVOR® ATV

Heavy or extreme duty, top access portable steel deck scales

SURVIVOR® SR

Heavy-duty, low profile, concrete or steel deck siderail scales

SURVIVOR® PT

Heavy-duty, pit-type, concrete or steel deck scales

SURVIVOR® Multi-Platform

SURVIVOR® ATV-M

Portable, Self-contained levertronic, steel deck scales

SURVIVOR® PT-M

Pit-type, levertronic, concrete deck scales

## Rail Scales:

[www.ricelake.com/railscales](http://www.ricelake.com/railscales)

SURVIVOR® RT

Pit-type, rail/truck combination scales

SURVIVOR® PL

Low profile, pit less scales

RailBoss™

Full or Double Draft rail scales

## Livestock Scales:

[www.ricelake.com/livestockscales](http://www.ricelake.com/livestockscales)

SURVIVOR® AG Series

Livestock/Agriculture utility scale

SURVIVOR® LV Series

Livestock ring scale

MAS-M, MAS-P, MAS-LC, MAS-LM

Multiple animal livestock scales

RoughDeck SLV

Single animal scale

Farm Bars

Universal load bars

# RailBoss™

Full Draft and Double Draft

## Railboss - Standard Features

---

- 80,000 lb axle capacity
- 320,000 lb full scale capacity
- 40,000 lb rail section capacity
- 90RE, 115RE or 132RE rail sections
- 5 ft 10 in rail sections, pre-drilled for joint bars

### Full Draft Package Includes:

- (8) 5 ft 10 in rail sections
- 30 ft of connecting cable
- Pre-drilled joint bars with connection hardware
- (2) Rice Lake junction boxes with transient protection
- 30 ft of homerun cable

### Double Draft Package Includes:

- (4) 5 ft 10 in rail sections
- 30 ft of connecting cable
- Pre-drilled joint bars with connection hardware
- (1) Rice Lake junction box with transient protection
- 30 ft of homerun cable

### Optional Features:

- Custom rail sizes are available
- \* 920i® indicator with RailBoss software for Full Draft or Double Draft applications
- Custom cable lengths

## Calibration Unit - Standard Features

---

- Battery powered IQ plus® 390 indicator
- Attachment hardware for 115RE and 132RE rails

## Specifications

---

### Load Cells:

40,000 lb

### Accuracy:

≤ 0.25% error typical, interchangeable with other gaged rail products

### Full Scale Capacity:

320,000 lb

### Axle Capacity:

80,000 lb

### Warranty:

Two-year limited warranty

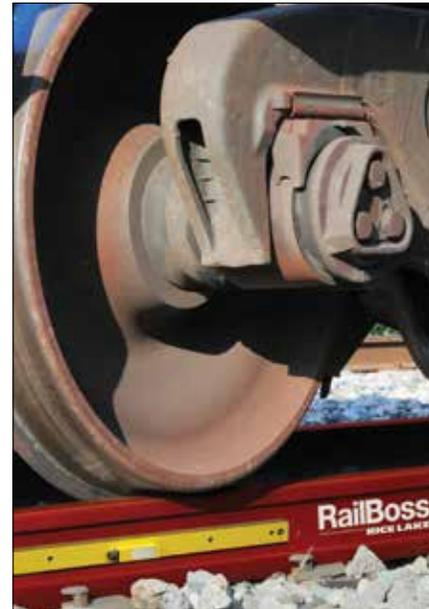

\* Non Legal for Trade

# RailBoss™

Full Draft and Double Draft

## Part Number/Price

PART #	DESCRIPTION	EST. SHIPPING WEIGHT	PRICE
164748	RailBoss Assembly Kit, Full Draft, 90RE Rail V2	2,280 lb	\$36,300.00
164749	RailBoss Assembly Kit, Double Draft, 90RE Rail V2	1,150 lb	18,100.00
162515	RailBoss Assembly Kit, Full Draft, 115RE Rail V2	2,550 lb	36,500.00
162516	RailBoss Assembly Kit, Double Draft, 115RE Rail V2	1,275 lb	18,200.00
164752	RailBoss Assembly Kit, Full Draft, 132RE Rail V2	2,800 lb	36,900.00
164753	RailBoss Assembly Kit, Double Draft, 132RE Rail V2	1,400 lb	18,500.00
126105	RailBoss 90 lb gauge assembly V2	290 lb	4,725.00
162517	RailBoss 115 lb gauge assembly V2	320 lb	4,725.00
118839	RailBoss 132 lb gauge assembly V2	350 lb	4,725.00
115564	RBS calibration/test unit	300 lb	9,300.00
119068	RBS calibration/test unit rental	300 lb	675.00 net/ per week
119073	Single channel 920i® indicator Double Draft with RailBoss software	10 lb	2,450.00
119072	Dual channel 920i® indicator Full Draft with RailBoss software	10 lb	2,550.00
126304	Three channel 920i indicator Full Draft with RailBoss software	10 lb	2,625.00
126111	90 RE Isolation Joint Bar Set, 4 sets required	40 lb	1,650.00
112702	115 RE Isolation Joint Bar Set, 4 sets required	50 lb	1,700.00
119771	132 RE Isolation Joint Bar Set, 4 sets required	60 lb	1,700.00
163004	30 ft interface cable		245.00
164873	60 ft interface cable		495.00
164874	100 ft interface cable		795.00

NOTE: 920i and RailBoss software must be ordered separately and is not included with the RailBoss assembly kit

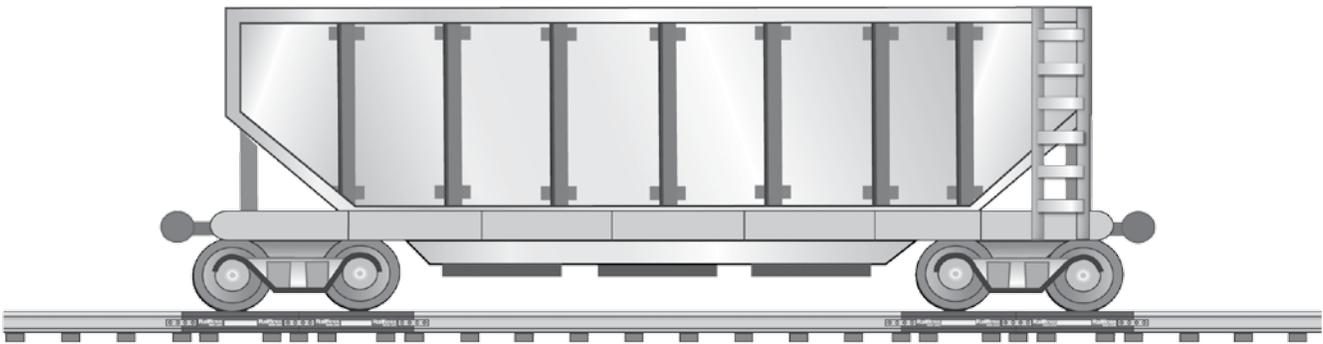

Full Draft

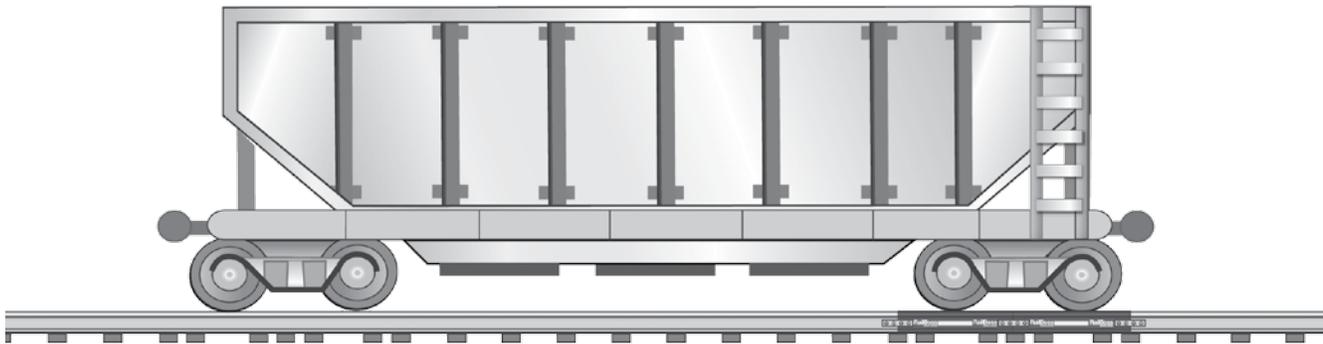

Double Draft

# RoughDeck® AX

Axle Scale

## Standard Features

- System includes two platforms and four on/off ramps
- Axle capacity - tandem platforms - 60,000 lb (two scales 30,000 lb each)

### Scale

- 32 W x 84 L x 6 in H
- 30,000 lb
- Contains four environmentally sealed, IP67 20,000 lb load cells per platform
- Treaded top plate with side access junction box
- JB4SS TuffSeal® Signal Trim junction box
- Top access foot adjustment holes
- Carbon steel captured ball feet
- 20 ft Survivor EL147HE cable
- Non Legal for Trade

### Ramps

- 32 W x 60 L x 6 in H
- Treaded top plate

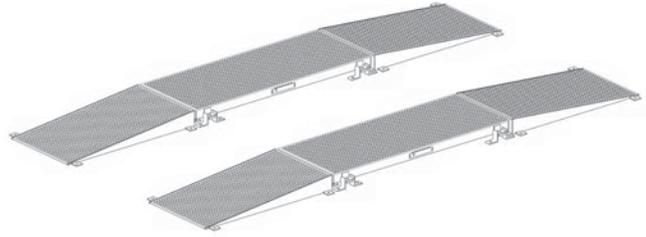

## Specifications

### End Loading Capacity:

133% full scale at 30,000 lb

### Warranty:

Five-year limited warranty

## Part Number/Price

PART #	DESCRIPTION	DIMENSIONS	EST. SHIP WEIGHT	PRICE
107637	60,000 lb (30,000 lb each)	32 x 205.5 x 6 in	3,600 lb	\$11,915.00
<b>RoughDeck AX Bundle Package</b>				
153058	60,000 lb (30,000 lb each) includes 920i Universal 115VAC with short axle program, SURVIVOR® 4 in LaserLight with Stop/Go light, TM U295 and RS-232 cable	32 x 205.5 x 6 in	3,700 lb	15,995.00

DIMENSIONS			
A	84.0 in (213.36 cm)	D	38.75 in (98.42 cm)
B	32.0 in (81.28 cm)	E	6.0 in (15.24 cm)
C	205.5 in (521.97 cm)		

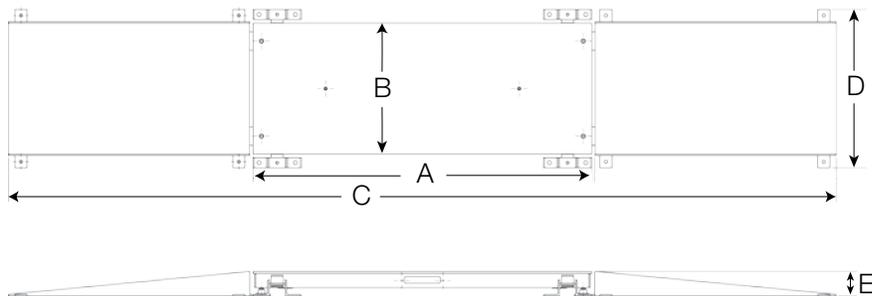

# AX3040

Axle Scale

## Standard Features

- Sizes: 7 ft, 12 ft and 14 ft lengths
- Construction: steel or aluminum
- Capacity: 60,000 lb or 80,000 lb
- JB4SS Tuff Seal Signal Trim Junction Box
- Treaded top plate with four lifting eyes
- 10 ft EL146HE Interconnect cable with MS-type connectors to go between weigh pads
- Contains two load cells per platform
- 50 ft EL147HE cable to connect weigh pad to indicator
- Non Legal for Trade

### Ramps

- 32 W x 25.25 in L
- Steel or aluminum



## Specifications

### Construction:

Steel or Aluminum

### Accuracy:

±3%

### End Loading Capacity:

100% full scale at 30,000 lb

75% full scale at 40,000 lb

### Warranty:

One-year limited warranty

## Part Number/Price

PART #	DESCRIPTION	DIMENSIONS	EST. SHIP WEIGHT	PRICE
<b>Steel Construction - Painted Black</b>				
112330	60,000 lb (30,000 lb each)	2.5 ft x 7 ft x 5.63 in	2,500 lb	\$10,760.00
111748	80,000 lb (40,000 lb each)	2.5 ft x 12 ft x 5.63 in	4,400 lb	12,735.00
112328	80,000 lb (40,000 lb each)	2.5 ft x 14 ft x 5.75 in	5,200 lb	16,900.00
<b>Steel Construction - AX3040 Bundle Package</b>				
153059	60,000 lb (30,000 lb each) includes 920i Universal 115 VAC with short axle program, SURVIVOR® 4 in LaserLight with Stop/Go light, TM U295 and RS-232 cable	2.5 ft x 7 ft x 5.63 in	2,600 lb	14,840.00
153060	80,000 lb (40,000 lb each) includes 920i Universal 115 VAC with short axle program, SURVIVOR® 4 in LaserLight with Stop/Go light, TM U295 and RS-232 cable	2.5 ft x 12 ft x 5.63 in	4,500 lb	16,815.00
153061	80,000 lb (40,000 lb each) includes 920i Universal 115 VAC with short axle program, SURVIVOR® 4 in LaserLight with Stop/Go light, TM U295 and RS-232 cable	2.5 ft x 14 ft x 5.75 in	5,300 lb	20,980.00
<b>Aluminum Construction - Glass Beaded</b>				
112329	60,000 lb (30,000 lb each)	2.5 ft x 7 ft x 5.63 in	1,250 lb	13,830.00
<b>Aluminum Construction - AX3040 Bundle Package</b>				
153062	60,000 lb (30,000 lb each) includes 920i Universal 115 VAC with short axle program, SURVIVOR® 4 in LaserLight with Stop/Go light, TM U295 and RS-232 cable	2.5 ft x 7 ft x 5.63 in	1,350 lb	17,910.00

DIMENSIONS			
<b>7 foot steel</b>			
A	83.60 in (2123.44 mm)	E	31.00 in (787.4 mm)
B	90.90 in (2308.86 mm)	F	32.00 in (812.8 mm)
C	141.25 in (3587.75 mm)	G	5.63 in (143.0 mm)
D	30.00 in (762.00 mm)		
<b>12 foot steel</b>			
A	143.60 in (3647.44 mm)	E	31.00 in (787.4 mm)
B	150.90 in (3832.86 mm)	F	32.00 in (812.8 mm)
C	201.2 in (5111.75 mm)	G	5.63 in (143.0 mm)
D	30.00 in (762.00 mm)		
<b>14 foot steel</b>			
A	167.60 in (4257.04 mm)	E	31.00 in (787.4 mm)
B	174.90 in (4442.46 mm)	F	32.00 in (812.8 mm)
C	225.25 in (5721.35 mm)	G	5.75 in (146.05 mm)
D	30.00 in (762.00 mm)		
<b>7 foot aluminum</b>			
A	83.60 in (2123.44 mm)	E	31.00 in (787.4 mm)
B	90.90 in (2308.86 mm)	F	32.00 in (812.8 mm)
C	141.25 in (3587.75 mm)	G	5.63 in (143.0 mm)
D	30.00 in (762.00 mm)		

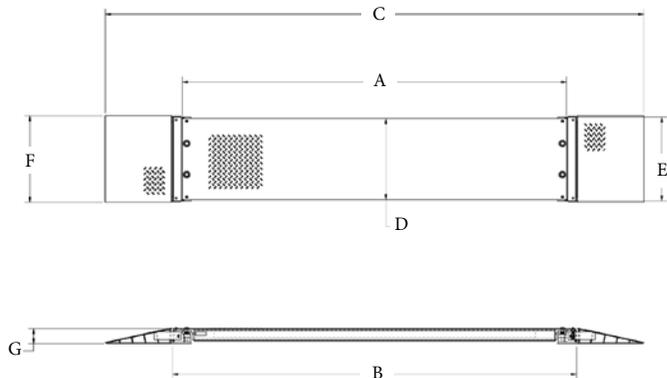



















# Worldwide Service

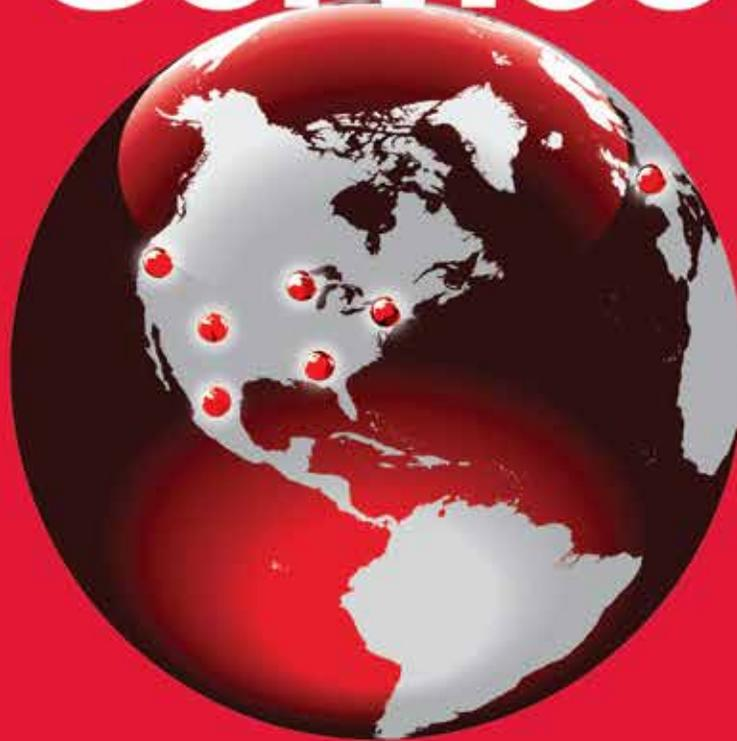

India

Netherlands

Mexico

Alabama, USA

Connecticut, USA

Nevada, USA

Washington, USA

Wisconsin, USA

To meet worldwide demand for products, Rice Lake Weighing Systems operates numerous manufacturing facilities across North America, as well as offices across the globe.

Providing the highest quality products and outstanding customer service is the foundation we're built upon. It's the driving force behind everything we do.

Rest assured that no matter where you are, our mission remains the same—to put the customer first, always.

**RICE LAKE**<sup>®</sup>  
WEIGHING SYSTEMS

To be the best by every measure<sup>®</sup>

1-800-472-6703

[www.ricelake.com](http://www.ricelake.com)

Over **40,000**  
weighing products  
and **3 million parts**  
distributed worldwide

The best by every measure

An industry leader for over 60 years, Rice Lake Weighing Systems offers an extensive product offering—providing the best scale quality and service across the world.

**RICE LAKE**  
WEIGHING SYSTEMS

230 W. Coleman St. • Rice Lake, WI 54868 • USA  
USA: 800-472-6703 • Canada/Mexico: 800-321-6703 • Direct: 715-234-9171 • FAX: 715-234-6967 • [www.ricelake.com](http://www.ricelake.com)

An ISO 9001 registered company © 2015 Rice Lake Weighing Systems PN 44301 1/15  
Specifications subject to change without notice